

## Device Boxes

.....

### Armoured and Nonmetallic Sheathed Cable Clamps









*Presenting the LHTQ family of Iberville boxes. With their additional cubic capacity, this family of boxes is designed for any installations that require a greater number of conductors such as heating, GFCI and arc-fault applications.*

*What's more, because it's an LHTQ, installation is always fast and accurate. Look for these practical and time saving features on all LHTQ models.*

- *positioning guides for drywall and outside wall applications*
- *retractable positioning tabs*
- *internally embossed mounting slots*
- *flat box sides for maximum stability*
- *holding prongs*
- *single and 2 gang boxes are CSA approved for one-screw mounting*

## Device Boxes

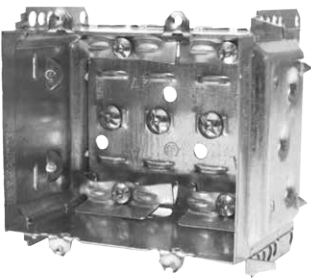
### Armoured and Nonmetallic Sheathed Cable Clamps

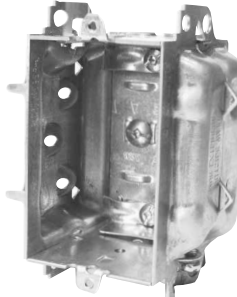
			
<p><b>BC1018-LHTQ</b></p> <p>Internally embossed slots for screw mounting. Fixed positioning tabs for single 1/2 in. drywall along with retractable positioning tabs for double 1/2 in. drywall applications. Fixed positioning tabs for outside wall applications. Holding prongs. One screw mounting.</p>	<p><b>BC1304-LHTQ</b></p> <p>Internally embossed slots for screw mounting. Fixed positioning tabs for single 1/2 in. drywall along with retractable positioning tabs for double 1/2 in. drywall applications. Fixed positioning tabs for outside wall applications. Holding prongs. One screw mounting.</p>	<p><b>BC2004-LHTQ</b></p> <p>Internally embossed slots for screw mounting. Fixed positioning tabs for single 1/2 in. drywall along with retractable positioning tabs for double 1/2 in. drywall applications. Fixed positioning tabs for outside wall applications. Holding prongs. One screw mounting.</p>	<p><b>BC2304-LHTQ</b></p> <p>Internally embossed slots for screw mounting. Fixed positioning tabs for single 1/2 in. drywall along with retractable positioning tabs for double 1/2 in. drywall applications. Fixed positioning tabs for outside wall applications. Holding prongs. One screw mounting.</p>
			
<p><b>BC2304-LHTQ-2</b></p> <p>Internally embossed slots for screw mounting. Fixed positioning tabs for single 1/2 in. drywall along with retractable positioning tabs for double 1/2 in. drywall applications. Fixed positioning tabs for outside wall applications. Holding prongs. One screw mounting.</p>	<p><b>BC2304-LHTQ-3</b></p> <p>Internally embossed slots for screw mounting. Fixed positioning tabs for single 1/2 in. drywall along with retractable positioning tabs for double 1/2 in. drywall applications. Fixed positioning tabs for outside wall applications. Holding prongs.</p>	<p><b>BC2304-LHTQ-4</b></p> <p>Internally embossed slots for screw mounting. Fixed positioning tabs for single 1/2 in. drywall along with retractable positioning tabs for double 1/2 in. drywall applications. Fixed positioning tabs for outside wall applications. Holding prongs.</p>	<p><b>BC3104-LHTQ</b></p> <p>Internally embossed slots for screw mounting. Fixed positioning tabs for single 1/2 in. drywall along with retractable positioning tabs for double 1/2 in. drywall applications. Fixed positioning tabs for outside wall applications. Holding prongs. One screw mounting.</p>

Cat. No.	Dimensions H x W x D (in.)	Volume (Cu. in.)	Gangable Yes or No	Features			Pryouts ends
				One screw mounting	Pos. tabs	Prov. for external nailing	
<b>BC1018-LHTQ</b>	3 x 2 x 3	18.0	yes	yes	yes	yes	4
<b>BC1304-LHTQ</b>	3 x 2 x 2-1/2	14.5	yes	yes	yes	yes	4
<b>BC2004-LHTQ</b>	3-3/4 x 2-3/16 x 2-3/4	20.5	no	yes	yes	yes	4
<b>BC2304-LHTQ</b>	3 x 2 x 2-1/2	14.5	no	yes	yes	yes	4
<b>BC2304-LHTQ-2</b>	3 x 3-3/4 x 2-1/2	27.0	no	yes	yes	yes	8
<b>BC2304-LHTQ-3</b>	3 x 5-1/2 x 2-1/2	39.5	no	no	yes	yes	12
<b>BC2304-LHTQ-4</b>	3 x 7-3/8 x 2-1/2	52.0	no	no	yes	yes	16
<b>BC3104-LHTQ</b>	3 x 2 x 2-1/2	16.0	yes	yes	yes	yes	4

Device Boxes

Conduit Knockouts



**CI425**  
"Screwlok" brackets for rework installation. Max. wall thickness: 5/8 in.



**BC1102**  
Recessed ears.



**CI1102-SB**

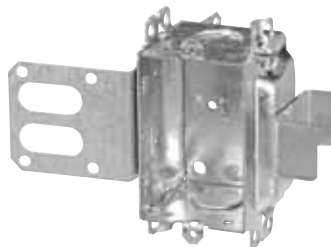

**CI3102-SSX**  
"Wraparound" bracket for 1-5/8 in. steel studs. With integral support bracket.



**BC1104**  
Recessed ears.







**CI1104-B**

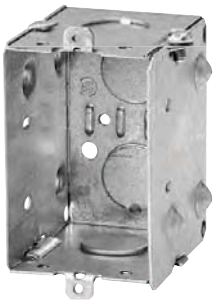

Cat. No.	Volume (Cu. in.)	Features		Knockouts	
		Ears	Bracket	1/2 in. ends	1/2 in. bottom
<b>2 in. Deep — Gangable — 3 in. x 2 in.</b>					
<b>CI425</b>	10.0	flush	rework	2	-
<b>BC1102</b>	10.0	recessed	-	2	-
<b>CI1102-SB</b>	10.0	-	"SB"	2	-
<b>CI3102-SSX</b>	12.0	-	"SSX"	2	-
<b>2-1/2 in. Deep — Gangable — 3 in. x 2 in.</b>					
<b>BC1104</b>	12.5	recessed	-	2	2
<b>CI1104-B</b>	12.5	-	"B"	2	2

## Device Boxes

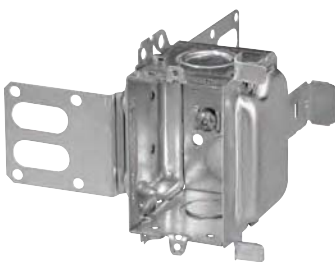
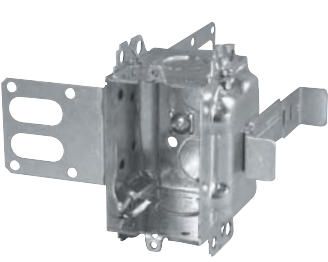
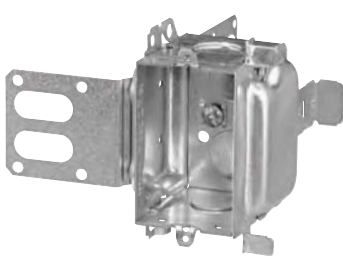
### Conduit Knockouts

			
<b>CI1104-K</b>	<b>BC1104-LE</b>	<b>CI1104-SB</b>	<b>BCR2000</b>
Concentric knockouts. Recessed ears.	Less ears.		
			
<b>CI3104-KSSX</b>	<b>BC3104-KSS1X-1</b>	<b>CI3104-SSX</b>	<b>CI1004</b>
Concentric knockouts. "Wraparound" bracket for 2-1/2 in. and 3-5/8 in. steel studs. With integral support bracket.	Concentric knockouts. "Wraparound" bracket for 2-1/2 in. and 3-5/8 in. steel studs. With integral support bracket. Brackets positioned for 2 layers of 1/2 in. Drywall.	"Wraparound" bracket for 2-1/2 in. and 3-5/8 in. steel studs. With integral support bracket.	Recessed ears.



Cat. No.	Volume (Cu. in.)	Features		Knockouts		
		Ears	Bracket	1/2 in. ends	1/2 in. bottom	3/4 in. ends
<b>2 in. Deep — Gangable — 3 in. x 2 in.</b>						
<b>CI1104-K</b>	12.5	recessed	-	2	2	2
<b>BC1104-LE</b>	12.5	-	-	2	2	-
<b>CI1104-SB</b>	12.5	-	"SB"	2	2	-
<b>CI3104-KSSX</b>	16.0	-	"SSX"	2	2	2
<b>BC3104-KSS1X-1</b>	16.0	-	"SSX"	2	2	2
<b>CI3104-SSX</b>	16.0	-	"SSX"	2	2	-
<b>3 in. Deep — Gangable — 3 in. x 2 in.</b>						
<b>CI1004</b>	15.0	recessed	-	2	2	-
<b>CI3004-KSSX-1.25</b>	18.0	-	"SSX"	-	1	2





Cat. No.	Volume (Cu. in.)	Usage	Ground Screw	Knockout
<b>2 in. Deep — Non-Gangable — 3-3/4 in. x 4 in. x 2 in.</b>				
<b>BCR2000*</b>	18.0	K0	2	2

\*Supplied c/w one CI4004 connector

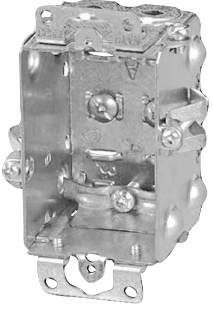
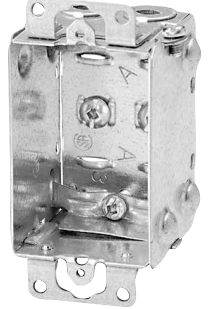

## Device Boxes

### Armoured and Nonmetallic Sheathed Cable Clamps

		
<p><b>BC1100-L</b></p>	<p><b>BC1100-LLE</b></p>	<p><b>CI1100-LRE</b></p>
<p>Flush ears.</p>	<p>Less ears.</p>	<p>Recessed ears.</p>
		
<p><b>CI425-L</b></p>	<p><b>BC1102-L</b></p>	<p><b>BC1102-LH</b></p>
<p>"Screwlok" brackets for rework installation. Max. wall thickness: 5/8 in.</p>	<p>Flush ears.</p>	<p>Provision for external nailing.</p>



Cat. No.	Volume (Cu. in.)	Features		Pryouts ends
		Ears	Bracket	
<b>1-1/2 in. Deep — Gangable — 3 in. x 2 in.</b>				
BC1100-L	8.0	flush	-	4
BC1100-LLE	8.0	-	-	4
CI1100-LRE	8.0	recessed	-	4
<b>2 in. Deep — Gangable — 3 in. x 2 in.</b>				
CI425-L	10.0	flush	rework	4
BC1102-L	10.0	flush	-	4
BC1102-LH	10.0	-	-	4

## Device Boxes

### Armoured and Nonmetallic Sheathed Cable Clamps



**CI775-L**

Flush ears.



**BC775-LD**

"Swing-arm" rework brackets.  
Max. wall thickness: 3/4 in.



**BC777-LRB**

Pivoting ends for rework installation.  
Max. wall thickness: 1-1/8 in.  
\* Non-Gangable



**CI525-L**

"Screwlok" brackets for rework installation. Max. wall thickness: 5/8 in.



**BC1104-LB**



**BC1104-LHT**

Positioning tabs. Provision for external nailing. Two embossed mounting slots for internal screw installation.

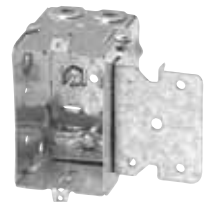

**CI1104-LMS**

Mounting strap with prongs. Recessed 1/2 in.



**BC1104-L**

Flush ears.



**BC1104-LRB**

Flat sides for rework applications.



**BC1104-LRW**

Rework bracket for closed wall applications. Max. wall thickness: 1 in.



**BC1104-LSSX**



**BC1304-LHTQ**

One screw mounting. Provision for external nailing. Positioning tabs for 1/2 in. and 3/4 in. drywall.



Cat. No.	Volume (Cu. in.)	Features		Pryouts ends	Knockouts 1/2 in. bottom
		Ears	Bracket		
<b>2-1/4 in. Deep — Gangable — 3 in. x 2 in. - For use with nonmetallic sheathed cable only</b>					
<b>CI775-L</b>	10.0	flush	-	4	1
<b>BC775-LD</b>	10.0	flush	rework	4	1
<b>BC777-LRB*</b>	11.0	-	rework	4	1
<b>2-1/2 in. Deep — Gangable — 3 in. x 2 in.</b>					
<b>CI525-L</b>	12.5	flush	rework	4	-
<b>BC1104-L</b>	12.5	flush	-	4	-
<b>BC1104-LB</b>	12.5	-	"B"	4	-
<b>BC1104-LHT</b>	12.5	-	P. Tabs	4	-
<b>CI1104-LMS</b>	12.5	-	"MS"	4	-
<b>BC1104-LRB</b>	12.5	flush	-	4	-
<b>BC1104-LRW</b>	12.5	flush	rework	4	-
<b>BC1104-LSSX</b>	12.5	-	"SSX"	4	-
<b>BC1304-LHTQ</b>	14.5	-	P. Tabs	4	-

## Device Boxes

### Armoured and Nonmetallic Sheathed Cable Clamps



**BC2104-LLE**

Holding prongs and prepositioned depth tabs.



**BC2304-LHTQ**

One screw mounting. Provision for external nailing. Positioning tabs for 1/2 in. and 3/4 in. drywall.



**BC2104-LX**

Self-locking spring clamps. Holding prongs and prepositioned depth tabs. Raised ground screws. **Approved for nonmetallic sheathed cable only.**



**BC2104-LN**

Staked nails. Holding prongs and prepositioned depth tabs.



**BC2104-LRB**

Flat sides for rework applications. 1 gang.



**BC2104-LLE-2**

2 gang. Holding prongs and prepositioned depth tabs.



**BC2104-LRB-2**

Flat sides for rework applications. 2 gang.

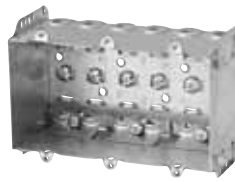

**BC2104-LLE-3**

3 gang. Holding prongs and prepositioned depth tabs.

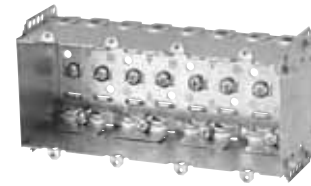

**BC2104-LLE-4**

4 gang. Holding prongs and prepositioned depth tabs.



**BC2304-LHTQ-2**

2 gang. Holding prongs and prepositioned depth tabs.

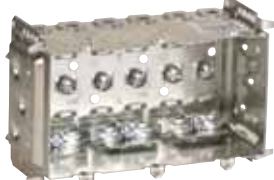

**BC2304-LHTQ-3**

3 gang. Holding prongs and prepositioned depth tabs.



**BC2304-LHTQ-4**

4 gang. Holding prongs and prepositioned depth tabs.



Cat. No.	Width (in.)	Volume (Cu. in.)	Features		Pryouts ends
			Ears	Bracket	
<b>2-1/2 in. Deep — Non-Gangable — 3 in. High</b>					
<b>BC2104-LLE</b>	2	12.5	-	P. Tabs	4
<b>BC2104-LLE-2</b>	3-3/4	25.0	-	P. Tabs	8
<b>BC2104-LLE-3</b>	5-1/2	37.5	-	P. Tabs	12
<b>BC2104-LLE-4</b>	7-3/8	50.0	-	P. Tabs	16
<b>BC2104-LN</b>	2	12.5	-	P. Tabs/Nails	4
<b>BC2104-LX</b>	2	12.5	-	P. Tabs	4
<b>BC2304-LHTQ</b>	2	14.5	-	P. Tabs	4
<b>BC2304-LHTQ-2</b>	3-3/4	27.0	-	P. Tabs	8
<b>BC2304-LHTQ-3</b>	5-1/2	39.5	-	P. Tabs	12
<b>BC2304-LHTQ-4</b>	7-3/8	52.0	-	P. Tabs	16
<b>BC2104-LRB</b>	2	12.5	-	-	4
<b>BC2104-LRB-2</b>	3-3/4	25.0	-	-	8

## Device Boxes

### Armoured and Nonmetallic Sheathed Cable Clamps



**CI2104-LSSA1X-1**

“Wraparound” bracket for 2-1/2 in. and 3-5/8 in. steel studs. With integral support bracket. Brackets positioned for 2 layers of 1/2 in. drywall.

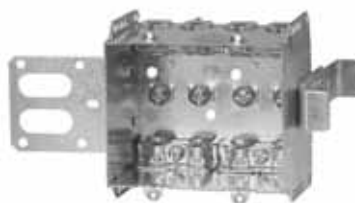

**CI2104-LSSA2X-1**

“Wraparound” bracket for 2-1/2 in. and 3-5/8 in. steel studs. With integral support bracket. Brackets positioned for 2 layers of 1/2 in. drywall.

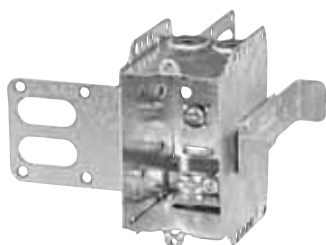

**CI2104-LSSX**

“Wraparound” bracket for 2-1/2 in. and 3-5/8 in. steel studs. With integral support bracket.

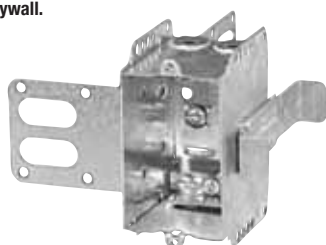

**CI2104-LSS1X-1**

“Wraparound” bracket for 2-1/2 in. and 3-5/8 in. steel studs. With integral support bracket. Brackets positioned for 2 layers of 1/2 in. drywall.

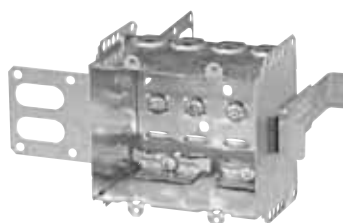

**CI2104-LSS2X-1**

“Wraparound” bracket for 2-1/2 in. and 3-5/8 in. steel studs. With integral support bracket. Brackets positioned for 2 layers of 1/2 in. drywall.

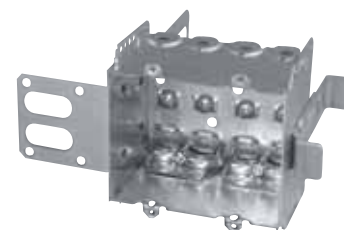

**CI2104-LSS2X**

“Wraparound” bracket for 2-1/2 in. and 3-5/8 in. steel studs. With integral support bracket.

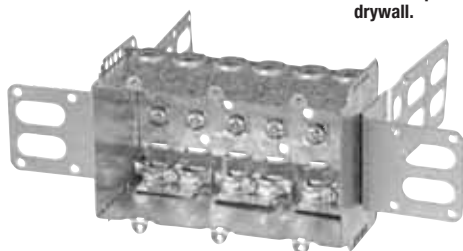

**CI2104-LSS3X-1**

“Wraparound” brackets for 2-1/2 in. and 3-5/8 in. steel studs. With integral support bracket. Brackets positioned for 2 layers of 1/2 in. drywall.

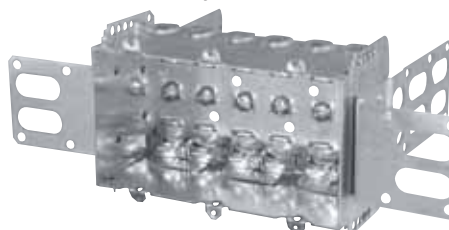

**CI2104-LSS3X**

“Wraparound” brackets for 2-1/2 in. and 3-5/8 in. steel studs. With integral support bracket.



**BC1504-LLE**

Holding prongs and prepositioned depth tabs on one side.



Cat. No.	Width (in.)	Volume (Cu. in.)	Features		Pryouts ends
			Ears	Bracket	
<b>2-1/2 in. Deep — Non-Gangable — 3 in. High</b>					
<b>CI2104-LSSA1X-1</b>	2	12.5	-	“SSX”	4
<b>CI2104-LSSA2X-1</b>	3-3/4	25.0	-	“SSX”	8
<b>CI2104-LSSX</b>	2	12.5	-	“SSX”	4
<b>CI2104-LSS1X-1</b>	2	12.5	-	“SSX”	4
<b>CI2104-LSS2X-1</b>	3-3/4	25.0	-	“SSX”	8
<b>CI2104-LSS2X</b>	3-3/4	25.0	-	“SSX”	8
<b>CI2104-LSS3X-1</b>	5-1/2	37.5	-	“SSX”	12
<b>CI2104-LSS3X</b>	5-1/2	37.5	-	“SSX”	12
<b>2-1/2 in. Deep — Non-Gangable — 3 in. High</b>					
<b>BC1504-LLE</b>	2-1/4	15.0	-	P. Tabs	4



Device Boxes

Armoured and Nonmetallic Sheathed Cable Clamps

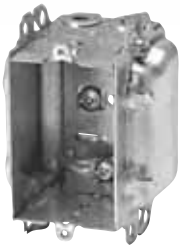

**BC3104-LH**

Positioning tabs. Provision for external nailing.



**BC3104-LHTQ**

One screw mounting. Provision for external nailing. Positioning tabs for 1/2 in. and 3/4 in. drywall.

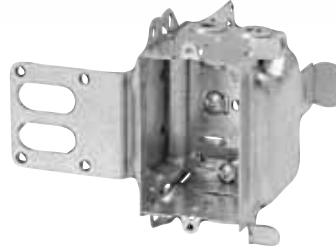

**BC3104-LSSX**

"Wraparound" bracket for 2-1/2 in. and 3-5/8 in. steel studs. With integral support bracket.

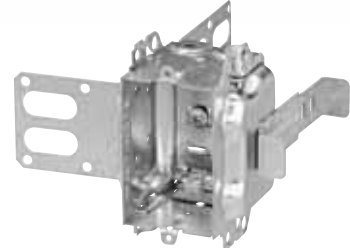

**CI3104-LSS1X-1**

"Wraparound" bracket for 2-1/2 in. and 3-5/8 in. steel studs. With integral support bracket. Brackets positioned for 2 layers of 1/2 in. drywall.



**CI1804-LH**

Positioning tabs. External nailing. Mounting slots for internal screw installation. X-Cube adds 5.5 cu. in.



**BC2004-LH**

Provision for external nailing. Holding prongs and prepositioned depth tabs on one side.



**BC2004-LHTQ**

Internally embossed slots for screw mounting. Fixed positioning tabs for single 1/2 in. drywall along with retractable positioning tabs for double 1/2 in. drywall applications. Fixed positioning tabs for outside wall applications. Holding prongs. One screw mounting.



**CI2016-LX**

Self-locking spring clamps. Holding prongs and prepositioned depth tabs on one side. **Approved for nonmetallic sheathed cable only.**



Cat. No.	Volume (Cu. in.)	Features		Pryouts ends
		Ears	Bracket	
<b>2-1/2 in. Deep — Gangable — 3 in. x 2 in.</b>				
<b>BC3104-LH</b>	16.0	-	P. Tabs	4
<b>BC3104-LHTQ</b>	16.0	-	P. Tabs	4
<b>BC3104-LSSX</b>	16.0	-	"SSX"	4
<b>CI3104-LSS1X-1</b>	16.0	-	"SSX"	4
<b>CI1804-LH</b>	18.0	-	P. Tabs	4
<b>2-3/4 in. Deep — Non-Gangable — 3-3/4 in. x 2-3/16 in.</b>				
<b>BC2004-LH</b>	18.5	-	P. Tabs	4
<b>BC2004-LHTQ</b>	20.5	-	P. Tabs	4
<b>2-1/2 in. Deep — Non-Gangable — 3-3/4 in. x 2 in.</b>				
<b>CI2016-LX</b>	18.5	-	P. Tabs	4

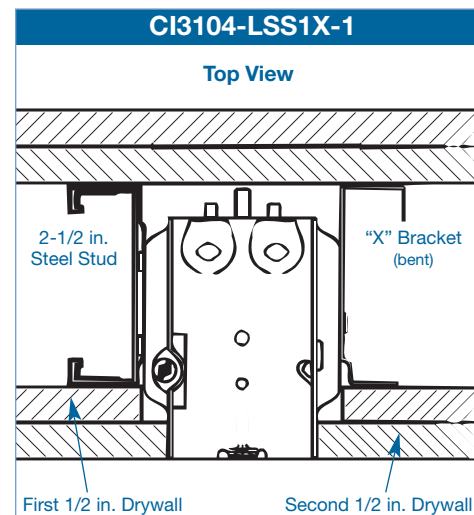

## Device Boxes

### Armoured and Nonmetallic Sheathed Cable Clamps



**BC1004-L**

Flush ears.



**BC1004-LH**

Positioning tabs. Provision for external nailing. Two embossed mounting slots for internal screw installation.



**CI1004-LB**

Side bracket wood stud.



**BC1018-LHTQ**

One screw mounting provisions for external nailing.



**BC1304-LHT**

Provision for external nailing.



**BC3004-LH**

Provision for external nailing.

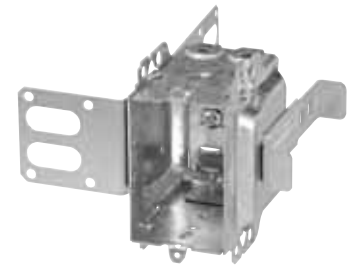

**CI3004-LSSX-1**

1 in. recessed brackets for 2-1/2 in. and 3-5/8 in. steel studs. Brackets positioned for 2 layers of 1/2 in. drywall.



Cat. No.	Volume (Cu. in.)	Features		Pryouts ends
		Ears	Bracket	
<b>3 in. Deep — Gangable — 3 in. x 2 in.</b>				
<b>BC1004-L</b>	15.0	flush	-	4
<b>BC1004-LH</b>	15.0	-	P. Tabs	4
<b>CI1004-LB</b>	16.0	-	"B"	4
<b>BC1018-LHTQ</b>	18.0	-	P. Tabs	4
<b>BC1304-LHT</b>	14.5	-	P. Tabs	4
<b>BC3004-LH</b>	18.0	-	-	4
<b>CI3004-LSSX</b>	18.0	-	"SSX"	4
<b>CI3004-LSSX-1</b>	18.0	-	"SSX"	4
<b>CI3004-LSSAX-1.25*</b>	18.0	-	"SSX"	4

\* Brackets positioned for 2 layers of 5/8 in. drywall

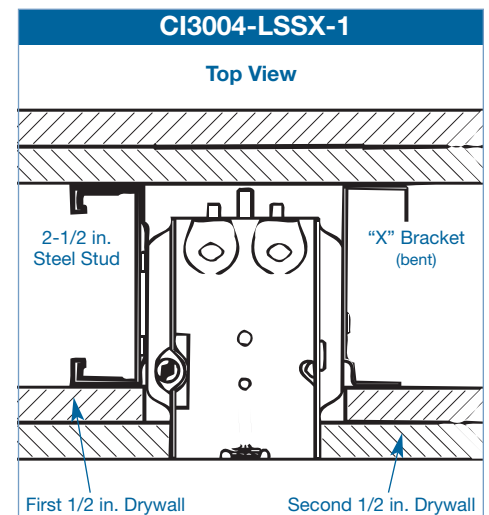

Device Boxes

Armoured and Nonmetallic Sheathed Cable Clamps

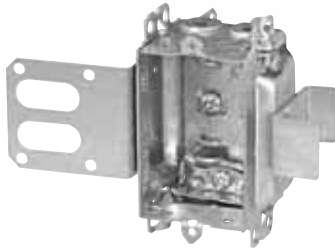

**CI3102-LSSAX**  
 "Wraparound" bracket for 1-5/8 in. steel studs. With integral support bracket.



**BC1104-LA**  
 Flush ears.



**BC1104-LHA**  
 Positioning tabs. Provision for external nailing. Two embossed mounting slots for internal screw installation.



**CI1104-LMSA**  
 Mounting strap recessed 1/2 in.

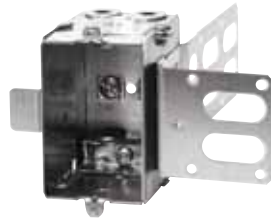

**BC1104-LSSAX**

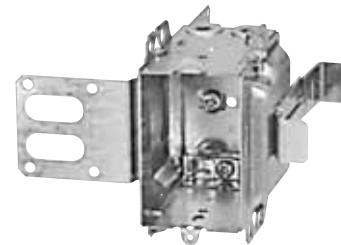

**CI3004-LSSAX-1**  
 1 in. recessed brackets for 2-1/2 in. and 3-5/8 in. steel studs. Brackets positioned for 2 layers of 1/2 in. drywall.



Cat. No.	Volume (Cu. in.)	Features		Pryouts ends
		Ears	Bracket	
<b>2 in. Deep — Gangable — 3 in. x 2 in.</b>				
<b>CI3102-LSSAX</b>	12.0	-	"SSX"	4
<b>2-1/2 in. Deep — Gangable — 3 in. x 2 in.</b>				
<b>BC1104-LA</b>	12.5	flush	-	4
<b>BC1104-LHA</b>	12.5	-	P. Tabs	4
<b>CI1104-LMSA</b>	12.5	-	"MS"	4
<b>BC1104-LSSAX</b>	12.5	-	"SSX"	4
<b>3 in. Deep — Gangable — 3 in. x 2 in.</b>				
<b>CI3004-LSSAX-1*</b>	18.0	-	"SSX"	4

\* Brackets positioned for 2 layers of 5/8 in. drywall

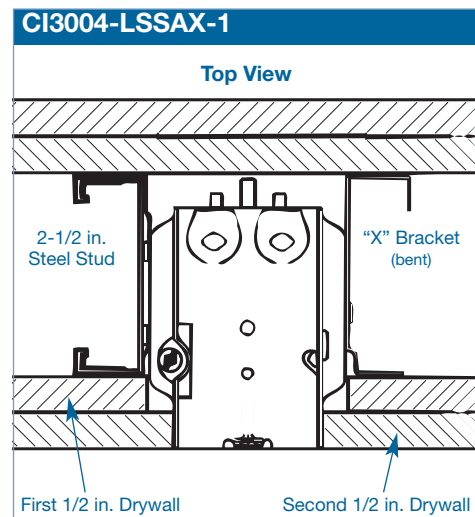

## Device Boxes

### Armoured and Nonmetallic Sheathed Cable Clamps



**CI2104-LLEA**

Holding prongs and prepositioned depth tabs.

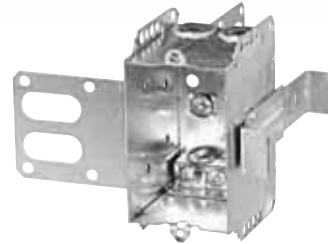

**CI2104-LSSAX**

"Wraparound" bracket for 2-1/2 in. and 3-5/8 in. steel studs. With integral support bracket.

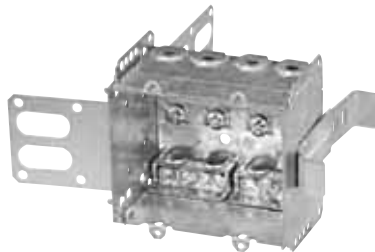

**CI2104-LSSA-2X**

2 gang. "Wraparound" bracket for 2-1/2 in. and 3-5/8 in. steel studs. With integral support bracket.

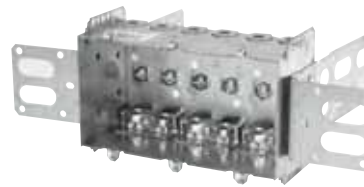

**CI2104-LSSA-3X**

3 gang. "Wraparound" bracket for 2-1/2 in. and 3-5/8 in. steel studs. With integral support bracket.



Cat. No.	Width (in.)	Volume (Cu. in.)	Features		Pryouts ends
			Ears	Bracket	
<b>2-1/2 in. Deep — Non-Gangable — 3 in. High</b>					
<b>CI2104-LLEA</b>	2	12.5	-	P. Tabs	4
<b>CI2104-LSSAX</b>	2	12.5	-	P. Tabs	4
<b>CI2104-LSSA-2X</b>	4	25	-	"SSX"	8
<b>CI2104-LSSA-3X</b>	6	37.5	-	"SSX"	12

## Device Boxes

### Armoured and Nonmetallic Sheathed Cable Clamps

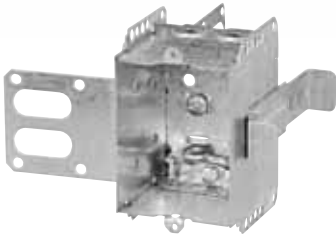

**CI1504-LSSAX**

"Wraparound" bracket for 2-1/2 in. and 3-5/8 in. steel studs. With integral support bracket.

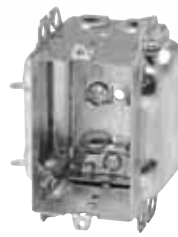

**CI3104-LHA**

Positioning tabs. Provision for external nailing.

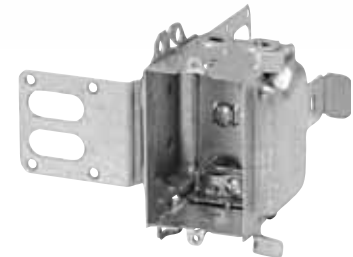

**BC3104-LSSAX**

"Wraparound" bracket for 2-1/2 in. and 3-5/8 in. steel studs. With integral support bracket.

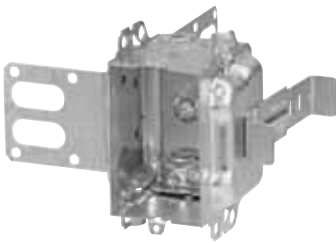

**CI3104-LSSA1X-1**

1 in. recessed brackets for 2-1/2 in. and 3-5/8 in. steel studs. Brackets positioned for 2 layers of 1/2 in. drywall.

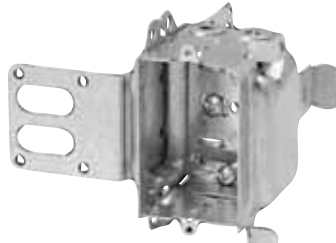

**BC3104-LSSX**

"Wraparound" bracket for 2-1/2 in. and 3-5/8 in. steel studs. With integral support bracket.



**CI2004-LHA**

Provision for external nailing. Holding prongs and prepositioned depth tabs.



**CI1004-LHA**

Positioning tabs. Provision for external nailing. Two embossed mounting slots for internal screw installation.



Cat. No.	Volume (Cu. in.)	Features		Pryouts ends
		Ears	Bracket	
<b>2-1/2 in. Deep — Non-Gangable — 3 in. x 2-1/4 in.</b>				
<b>CI1504-LSSAX</b>	15.0	-	"SSX"	4
<b>2-1/2 in. Deep — Gangable — 3 in. x 2 in.</b>				
<b>CI3104-LHA</b>	16.0	-	P. Tabs	4
<b>BC3104-LSSAX</b>	16.0	-	"SSX"	4
<b>CI3104-LSSA1X-1</b>	16.0	-	"SSX"	4
<b>BC3104-LSSX</b>	16.0	-	P. Tabs	4
<b>2-3/4 in. Deep — Non-Gangable — 3-3/4 in. x 2-3/16 in.</b>				
<b>CI2004-LHA</b>	18.5	-	P. Tabs	4
<b>3 in. Deep — Gangable — 3 in. x 2 in.</b>				
<b>CI1004-LHA</b>	15.0	-	P. Tabs	4

## Boxes for ICF Construction

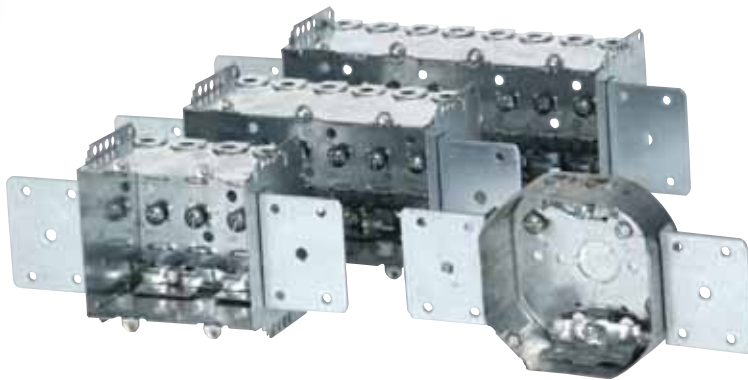

Cat. No.	Description	Volume (Cu. in.)
<b>BC2104-LMS-1</b>	1-gang	12.5
<b>BC2104-LMS-2</b>	2-gang	25.0
<b>BC2104-LMS-3</b>	3-gang	37.5
<b>BC2104-LMS-4</b>	4-gang	50.0
<b>BC54151-LMS</b>	Octagonal	15.0

## Device Boxes

### Did you know...

When armoured cable (BX) is terminated in a device box, an anti-short bushing must be inserted between the conductors and the armour of the cable. Also, there must be a means of preventing the armour from entering into the box beyond the cable clamp.

**IBERVILLE®** has two solutions that accomplish these tasks.

Our "LA" cable clamp:

**A** This clamp has been designed so that the anti-short bushing and the armour butt-up against a retaining wall built into the clamp.

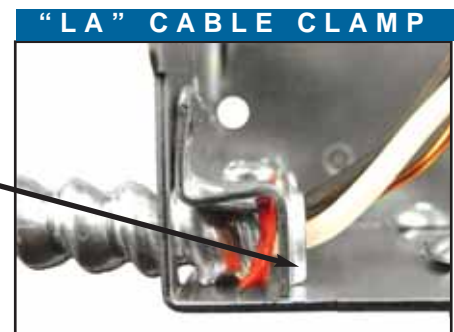

### DUAL USAGE BOX

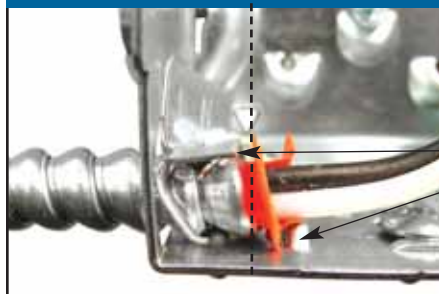

Our dual usage boxes feature retaining flanges built into the bottom of the spacer, that in unison with the cable clamp, hold the anti-short bushing in place and prevent the armour from penetrating into the box.

**B**

### Device Boxes

### Stainless Steel Wall Plates

#### General Usage



#### Toggle Switch



CI97071

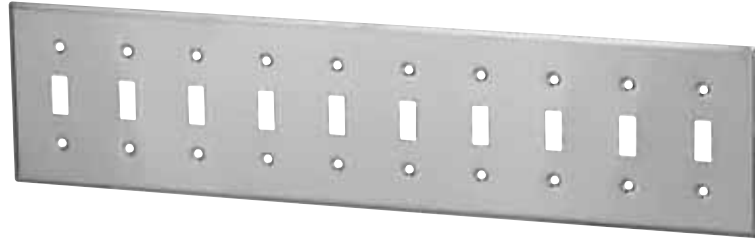

CI97080

1 gang to 10 gangs

#### Duplex Receptacle

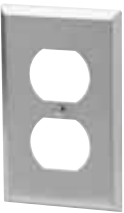

CI97101



CI97102

#### Blank Box Mounting (3.281 in.)



CI97011

#### GFCI / Decora



CI97401

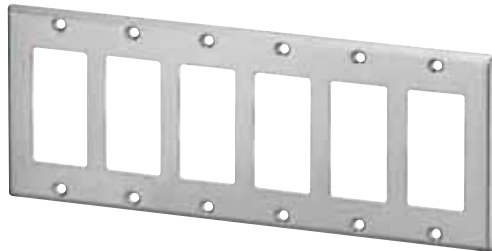

CI97406

1 gang to 6 gangs

#### Blank Device Mounting (2.375 in.)



CI97121



CI97124

1 gang to 4 gangs

#### Combination Switch / Receptacle



CI97532

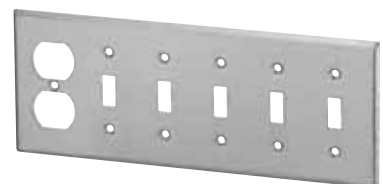





CI97573

2 gangs to 7 gangs

## Device Boxes

### Stainless Steel Wall Plates





### Specialty Usage

Telephone		Emergency	Single Receptacle	GFCI Conversion Kit
				
<b>* CI97181</b>	<b>* CI97191</b>	<b>CI6851-RF</b>	<b>CI97091</b>	<b>BC97002</b>
3/8 in. opening.	5/8 in. opening.	ON / OFF	1-13/32 in. diameter.	For 4 in. square boxes.

### 347 Volt Toggle Specialty Usage

For 1204 Series			For MBD / MBS Series
			
<b>CI6851-HV</b>	<b>CI6854-HV</b>	<b>CI6851-HV</b>	<b>CI97074-HVR</b>
	1 gang to 4 gangs		1 gang to 4 gangs

### 347 Volt Blank

For 1204 Series		For MBD/MBS Series	
			
<b>CI97151-HV</b>	<b>CI97154-HV</b>	<b>CI97151-HV</b>	<b>CI97154-HVR</b>
	1 gang, 2 gangs and 4 gangs		1 gang, 2 gangs and 4 gangs



Device Boxes

Stainless Steel Wall Plates

Dimensions

Standard Wall Plate

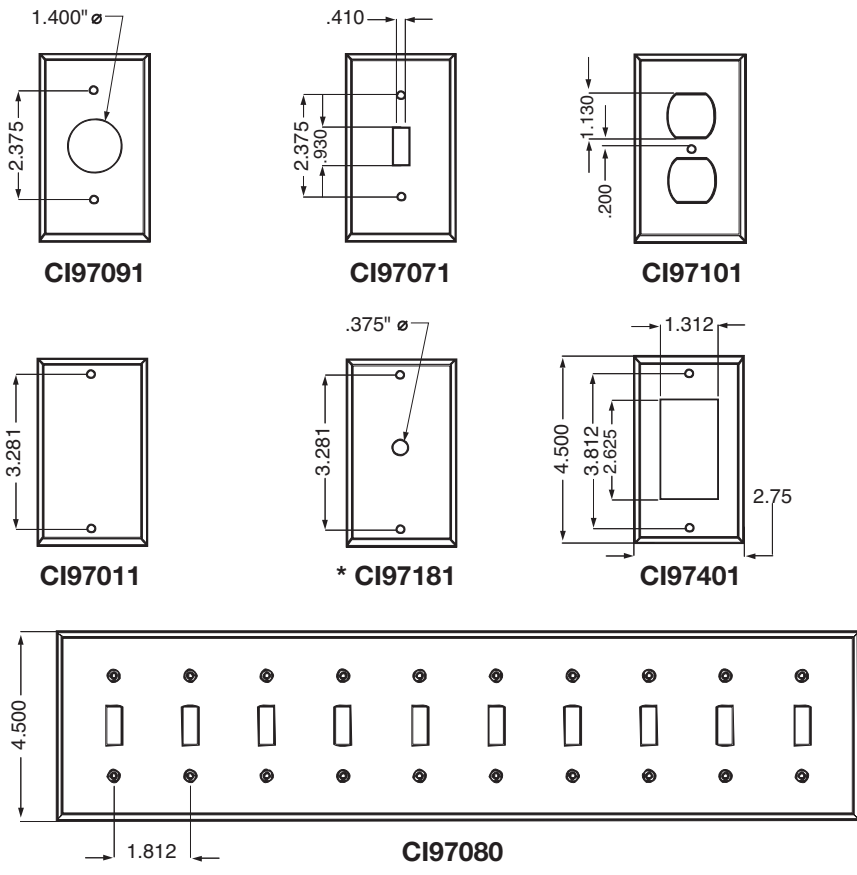

Mounting Hole Spacings

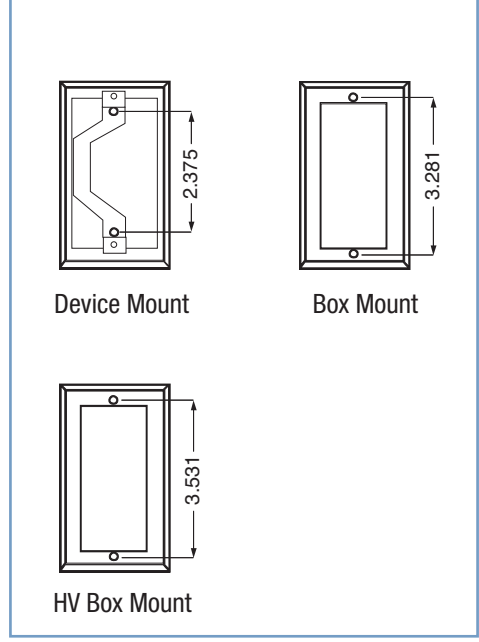

347 Volt Wall Plate

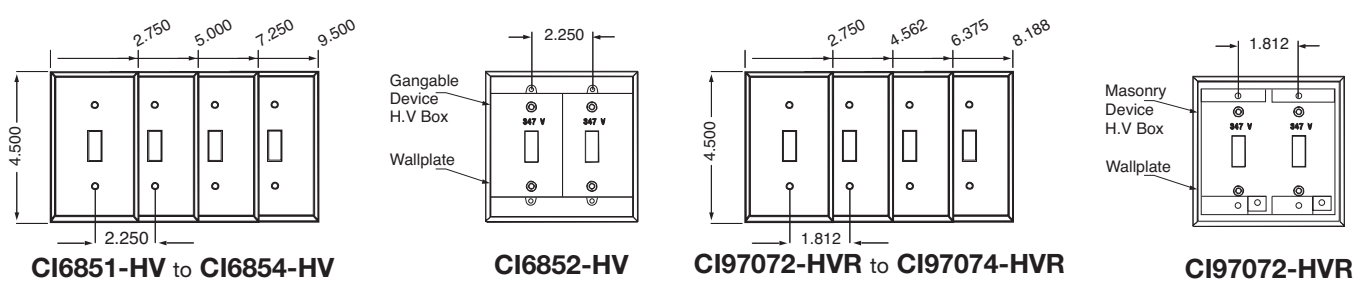



Dimensions are in inches.

## Device Boxes

### Stainless Steel Wall Plates

#### Selection Guide

DESCRIPTION	1 GANG	2 GANGS	3 GANGS	4 GANGS	5 GANGS	6 GANGS	7 GANGS	8 GANGS	9 GANGS	10 GANGS
Toggle Switch	CI97071	CI97072	CI97073	CI97074	CI97075	CI97076		CI97078	CI97079	CI97080
Duplex Receptacle	CI97101	CI97102								
Blank Boxes										
Mounting 3.281 in.	CI97011	CI97012	CI97013	CI97014						
Blank Device										
Mounting 2.375 in.	CI97121	CI97122	CI97123	CI97124						
GFCI / Decora	CI97401	CI97402	CI97403	CI97404	CI97405	CI97406				
GFCI Conversion Kit		BC97002								
Combination Switch / Receptacle		CI97532			CI97563	CI97573				
15 A Receptacle	CI97091									
Telephone 3/8 in. Opening	* CI97181									
Telephone 5/8 in. Opening	* CI97191									
Emergency On / Off	CI6851-RF									
347 Volt Toggle for 1204 Series	CI6851-HV	CI6852-HV	CI6853-HV	CI6854-HV						
347 Volt Blank for 1204 Series	CI97151-HV	CI97152-HV		CI97154-HV						
347 Volt Toggle for MBD and MBS Series	USE CI6851-HV	CI97072-HVR	CI97073-HVR	CI97074-HVR						
347 Volt Blank for MBD and MBS Series	USE CI97151-HV	CI97152-HVR		CI97154-HVR						

  \* Not applicable.

#### Technical Specifications

### Type 430 Stainless Steel

- › 16% chrome
- › Corrosion resistant
- › Recommended for industrial, commercial and institutional applications
- › Supplied with nickel plated brass screws
- › 1 to 3 gangs — Vertically Brushed
- › 4 gangs and up — Horizontally Brushed