

## Contents

---

<b>General Specifications</b>	2-2
<b>Catalogue Numbering System</b>	2-2
<b>240V Meter Centre</b>	
Overview - Features & Benefits	2-3
Selection Procedure	2-5
Switches and Tap Boxes	2-6
Meter Stacks	2-7
Socket Module and Main Bus Connector Kit	2-8
Sub-service Circuit Breakers and Corner Elbow Modules	2-9
Accessories	2-10
Configuration Layouts	2-11
Dimensions	2-13
Knock Out Data	2-15
240V Meter Centre Layout Example	2-16
<b>600Y/347V Meter Centre</b>	
Overview - Features & Benefits	2-17
Meter Stacks	2-18
Sub service Circuit Breakers and Tap Boxes	2-19
Close Coupled option with SMP	2-20
Main Bus Connector Kits, Corner Elbow Modules and Accessories	2-21
Dimensions	2-22
600Y/347V Meter centre Layout Example	2-26

# Meter Centres

## Introduction and General Specifications

*General*

Siemens multi-family metering includes an assortment of module types that can be configured to meet a wide range of residential, commercial or industrial group metering applications. This feature-rich product line is designed with the contractor in mind. Quality and service are keystones of Siemens meter centres. Siemens meter centres are designed and manufactured in Canada, to meet Canadian requirements.

### General Specifications

#### Standards

CSA: C22.2 No. 229-M1988. Certified under file #153416

#### Meter Stack Design

Siemens meter stacks are of uniform design with flexibility in mind. All meter stacks are designed for "cold metering" in which individual subservice breakers are connected on the line side of the meter sockets thereby protecting the meter and all electrical equipment installed subsequent to it.

#### Meter Stack Enclosure

Type 1 enclosure. Meter stack enclosure, barriers and end plates are manufactured of galvanized steel. Front covers are fabricated of phosphatized steel finished with ASA 61 light grey paint.

#### Bus Bar

The main horizontal bus consists of tin plated high conductivity aluminum for maximum performance and economy. The main cross bus is installed at the bottom of metering stacks and is rated at at 600A or 1200A while the vertical bussing is rated at 800A per section.

### Numbering System

#### Meter Stacks

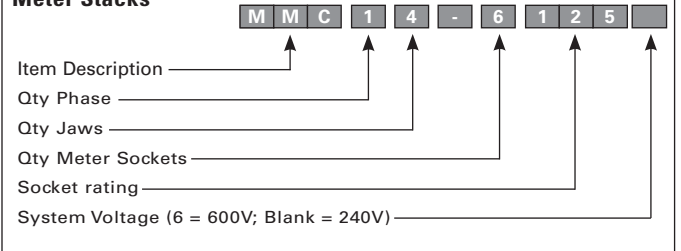

#### Meter Sockets

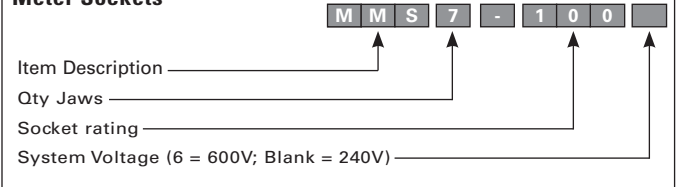

#### Tap Boxes

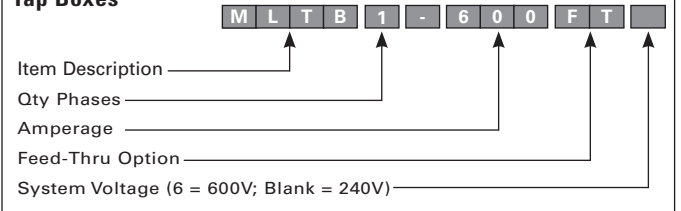

# Meter Centres

## 240V Modular Meter Centres

*Selection*

The Siemens metering line offers an economical approach to virtually any metering requirement, whether it be for residential, commercial or industrial applications at 240V.

### Meeting All Your Service Needs

Offering the maximum versatility to meet all your needs, Siemens 240V meter centres are designed for single phase three wire 120/240V AC or three phase four wire 120/208V AC applications with sub-service modules of 100A, 125A and 200A. Siemens 240V meter centres are designed to meet CSA requirements C22.2 No.229 and are CSA certified under file #13069. All individual metering stacks are manufactured to tight specifications and can be selected in pre-assembled units, to minimize on-site labour or as a separate plug-in module for a customized installation when required. The modular construction offers real post installation flexibility permitting on-site changes to be made with minimum down time.

### Direct Tap Feature

When using Siemens' direct tap Main Lug Feed Kit for services at 600A, no tap box is required, therefore saving considerable installation room.

This custom designed Main Lug Feed Kit allows connection of main incoming cables directly to the Meter Stack main bus and eliminates the need for a sub service tap box. If more working space is required to facilitate the connection, a Transition Box can be used.

### Meter Stack Design

All Siemens meter stacks are of uniform design with flexibility in mind. A combination of slide-in metering modules from 100 to 200A fit in any meter stack.

### Mounting Rails

Easy to use, the mounting rails simplify installation of the modular meter centre. They enable the metering stacks to be rapidly pre-installed on the wall, automatically aligning the sections for permanent mechanical installation and electrical joining of the main bus.



### Meter Stack Enclosure

Type 1 meter stack enclosure. Enclosure, barriers and end plates are manufactured of galvanized steel. Front covers are fabricated of phosphatized steel finished with ASA 61 light grey paint. Meter socket front covers are embossed and fitted with a label to allow suite identification on the enclosure adjacent to its respective service breaker.

### Bus Bar

The main horizontal bus consists of tin plated high conductivity aluminum for maximum performance and economy. The main cross bus is installed at the bottom of the metering stacks and is rated at 600 or 1200A while the vertical bussing is rated at 800A per section.

### Flexibility

Siemens service entrance equipment can be top or bottom fed, depending on site requirements, for single connection or feed through applications.

Each meter stack has a convenient side wireway for branch wiring which can exit at the top or at the bottom. A user-friendly combination of knockouts is factory installed at the top to minimize installation time.

### Slide-in Modular Design

Each individual slide-in module design allows for fast installation and provide flexibility for future needs. If the branch requirement changes, the module can be interchanged without changing the complete stack. By simply removing two screws from the front cover, the slide-in module can be removed for easy replacement.

### Entry Plates

Main cable tap boxes can be provided with punched or unpunched aluminum or fiber entry plates.

### Branch Circuit Breakers

Compact, high performance type plug-in or bolt-on circuit breakers can be selected to address site requirements. Interrupting ratings up to 100kA combine thermal and magnetic trip elements and feature: isolated pole construction with common trip bar for multiple pole devices; silver alloy contacts and high pressure straight-in load connectors.

Series rating are also available for approved combinations up to 100kA.

### Meter Socket Jaws

Meter socket jaws consist of tin plated copper with steel spring reinforced clips for reliable contact pressure. Positive alignment of jaws and stabs is assured by bus straps which are bolted in place.

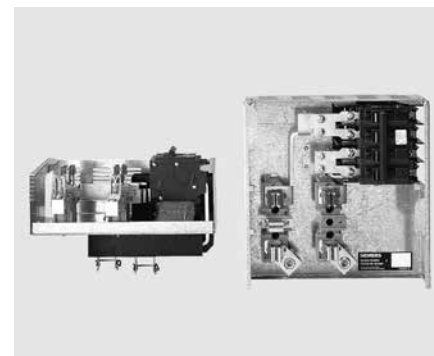

# Meter Centres

## 240V Modular Meter Centres

*Selection*

### Overview - Features & Benefits

2  
METER CENTRES

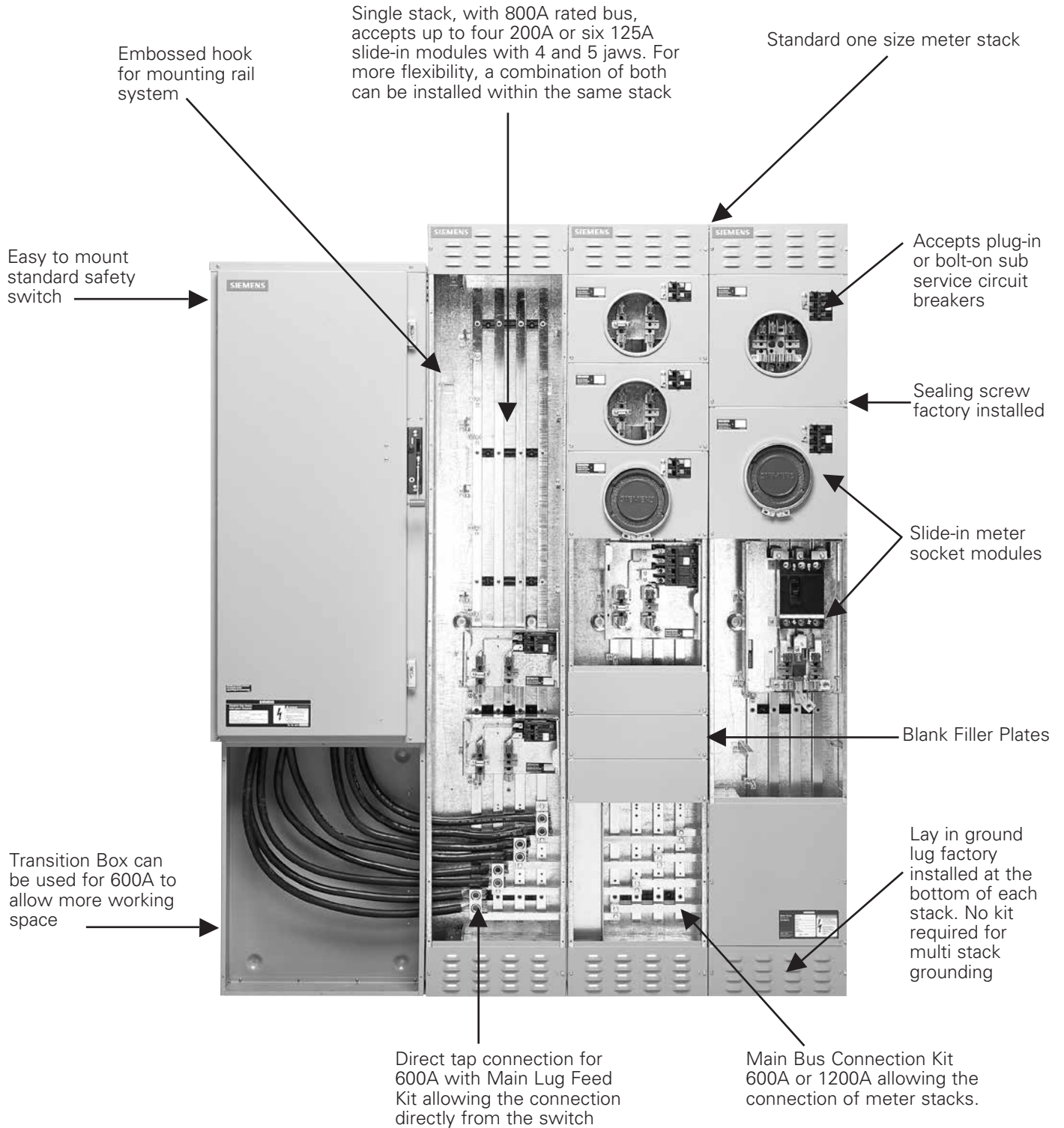

# Meter Centres

## 240V Modular Meter Centres

Selection

### Selection Procedure

1. Select service entrance equipment (ex. switch), reference p.2-6.
2. Select required Tap Box or Main Lug Feed Kit with or without a Transition Box.
3. Select type and quantity of slide-in Meter Socket Modules.
4. Select Main Bus Connector Kits to join each stack.
5. Select quantity of Blank Filler Plates as per left over empty space.

Examples - Typical 600A Main Service 120/240V 1Ø 3W c/w 16 x 100A and 1 x 200 sub-service breakers					
Option 1 c/w Tap Box & Bolt-on Breakers			Option 2 c/w Transition Box & Plug-in Breakers		
QTY	Catalogue Number	Description	QTY	Catalogue Number	Description
1	ID226 or HFC226N	Safety switch 600A 2p 240V	1	ID226 or HFC226N	Safety switch 600A 2p 240V
1	MLTB1-600	Standard Tap Box 600A	1	MTB-600	Transition Box 600A
4	MMS4-125	Meter socket module 125A 4 jaws	1	MLFK1	Main lug kit
1	MMS4-200QJ	Meter socket module 200A 4 jaws QJ	4	MMS4-125	Meter socket module 125A 4 jaws
2	MMC14-6125	Complete stack	1	MMS4-200	Meter socket module 200A 4 jaws
1	MMC1	Basic stack	2	MMC14-6125	Complete stack
2	MBSS1-600	Main bus connector kit	1	MMC1	Basic stack
1	MBHP-2	Blank filler plates	2	MBSS1-600	Main bus connector kit
16	BQ2B100	100A Bolt-on breaker	1	MBHP-2	Blank filler plates
1	QJ22B200	200A Bolt-on breaker	16	Q2100	100A Plug-in breaker
1	MTRK-64	Wall mounting rail	1	EQ9685	200A Plug-in breaker
			1	MTRK-64	Wall mounting rail

### Reference Chart: Number of Blank Filler Plate Kits Required

Refer to this chart to calculate how many Blank Filler Plate Kits are needed in a meter stack after the quantity of Meter Socket Module is determined.			
Catalogue Number	Description	Height in modules (1 module = 8 <sup>7/8</sup> " = 125 mm)	Qty of kits #MBHP-2 (2 plates/kit)
MMC1 & MMC3	Basic meter stack	6 modules	6
MMS4-125	Meter socket module 125A 4 jaws	1 module	1
MMS5-125	Meter socket module 125A 5 jaws	1 module	1
MMS4-200	Meter socket module 200A 4 jaws	1.5 modules	2
MMS5-200	Meter socket module 200A 5 jaws	1.5 modules	2
MMS4-200QJ	Meter socket module 200A 4 jaws QJ	1.5 modules	2
MMS5-200QJ	Meter socket module 200A 5 jaws QJ	1.5 modules	2
MMS7-100	Meter socket module 100A 7 jaws	1.5 modules	2
MMS7-200	Meter socket module 200A 7 jaws	3 modules	3

# Meter Centres

## 240V Modular Meter Centres

Selection

### Fusible Switches<sup>①</sup>

System	Ampere Rating	Catalogue Number	Cable lug size per phase - suitable for Al. and Cu.	Dimensions - Inches (mm)			Weight - lbs.(kg)
				H	W	D	
120/240 1Ø 3W	400	ID225	(1) 1/0 AWG - 750 Kcmil or (2) 1/0 AWG - 250 Kcmil	40 (1016)	18 <sup>1/2</sup> (470)	12 <sup>1/16</sup> (306)	78 (35.4)
	600	ID226	(2) 1/0 AWG - 750 Kcmil or (4) 1/0 AWG - 250 Kcmil	48 (1219)	21 <sup>1/2</sup> (546)	12 <sup>1/16</sup> (306)	92 (41.7)
	800	HFC227N	(1) 1/0 AWG - 750 Kcmil	67 <sup>3/16</sup> (1706)	39 <sup>15/16</sup> (1015)	9 <sup>1/4</sup> (235)	365 (65.6)
	1200	HFC228N	(2) 1/0 AWG - 750 Kcmil	67 <sup>3/16</sup> (1706)	39 <sup>15/16</sup> (1015)	9 <sup>1/4</sup> (235)	385 (174.6)
120/208 3Ø 4W	400	ID425	(1) 1/0 AWG - 750 Kcmil or (2) 1/0 AWG - 250 Kcmil	40 (1016)	18 <sup>1/2</sup> (470)	12 <sup>1/16</sup> (306)	92 (41.7)
	600	ID426	(2) 1/0 AWG - 750 Kcmil or (4) 1/0 AWG - 250 Kcmil	48 (1219)	21 <sup>1/2</sup> (546)	12 <sup>1/16</sup> (306)	108 (49)
	800	HFC367N	(1) 1/0 AWG - 750 Kcmil	67 <sup>3/16</sup> (1706)	39 <sup>15/16</sup> (1015)	9 <sup>1/4</sup> (235)	375 (170.1)
	1200	HFC368N	(2) 1/0 AWG - 750 Kcmil	67 <sup>3/16</sup> (1706)	39 <sup>15/16</sup> (1015)	9 <sup>1/4</sup> (235)	395 (179.1)

### Standard Tap Boxes<sup>②</sup> - Connectors included

System	Ampere Rating	Catalogue Number	Cable lug size per phase - suitable for Al. and Cu cables <sup>③</sup>	Dimensions - Inches (mm)			Weight - lbs.(kg) <sup>④</sup>
				H	W	D	
120/240 1Ø 3W	400/600	MLTB1-600	(3) #2 AWG - 600 Kcmil	25 <sup>3/4</sup> (655)	20 <sup>1/2</sup> (521)	7 <sup>1/4</sup> (184)	40 (18.2)
	800/1200	MLTB1-1200 <sup>⑤</sup>	(4) 1/0 AWG - 750 Kcmil	25 <sup>3/4</sup> (655)	20 <sup>1/2</sup> (521)	7 <sup>1/4</sup> (184)	45 (20.5)
120/208 3Ø 4W	400/600	MLTB3-600	(3) #2 AWG - 600 Kcmil	25 <sup>3/4</sup> (655)	20 <sup>1/2</sup> (521)	7 <sup>1/4</sup> (184)	40 (18.2)
	800/1200	MLTB3-1200 <sup>⑤</sup>	(4) 1/0 AWG - 750 Kcmil	25 <sup>3/4</sup> (655)	20 <sup>1/2</sup> (521)	7 <sup>1/4</sup> (184)	45 (20.5)

### Feed Through Tap Boxes<sup>⑥</sup> - Connectors included, use with even number of meter stacks only

120/240 1Ø 3W	400/600	MLTB1-600FT	(4) 250 Kcmil - 750 Kcmil or	25 <sup>3/4</sup> (655)	20 <sup>1/2</sup> (521)	7 <sup>1/4</sup> (184)	45 (20.5)
	800/1200	MLTB1-1200FT <sup>⑤</sup>	(8) 3/0 AWG - 250 Kcmil	46 <sup>1/4</sup> (1175)	24 (610)	7 <sup>1/4</sup> (184)	60 (27.3)
120/208 3Ø 4W	400/600	MLTB3-600FT	(4) 250 Kcmil - 750 Kcmil or	25 <sup>3/4</sup> (655)	20 <sup>1/2</sup> (521)	7 <sup>1/4</sup> (184)	45 (20.5)
	800/1200	MLTB3-1200FT <sup>⑤</sup>	(8) 3/0 AWG - 250 Kcmil	46 <sup>1/4</sup> (1175)	24 (610)	7 <sup>1/4</sup> (184)	60 (27.3)

### Main Lug Feed Kit - For direct tap (no tap box) from safety switch to meter stack

System	Ampere Rating	Catalogue Number	Cable lug size per phase - suitable for Al. and Cu cables	Use with Meter Module Type	Weight - lbs.(kg)	 MLFK1
120/240 1Ø 3W	400/600	MLFK1	(1) 250 Kcmil - 750 Kcmil Cu/Al or (2) 3/0 AWG - 250 Kcmil Cu/AL	MMC1 or MMC14-6125	2 <sup>1/2</sup> (1.1)	
120/208 3Ø 4W	400/600	MLFK3	(1) 250 Kcmil - 750 Kcmil Cu/Al or (2) 3/0 AWG - 250 Kcmil Cu/AL	MMC3 or MMC35-6125	3 (1.3)	

### Transition Box - Allows more working space to connect on Main Lug Feed Kit

System	Ampere Rating	Catalogue Number	Dimensions - Inches (mm)			Weight - lbs.(kg)	 MTB-600
			H	W	D		
120/240 1Ø 3W	400/600	MTB-600	25 <sup>3/4</sup> (655)	20 <sup>1/2</sup> (521)	7 <sup>1/4</sup> (184)	30 (13.7)	
120/208 3Ø 4W							

① Fusible switch can be mounted directly next to metering stack with a Standard Tap Box or with a Main Lug Feed Kit (with or without Transition Box).

② Tap Box mounts directly next to the Meter Stack and is required to accommodate incoming main service cable, unless Main Lug Feed Kit is used. Suitable for left and right side entry.

③ Can be used with even and odd number of metering stacks. In addition, for odd number of stack connections, adaptor kit #MTBK12 must be used.

④ Weight is based on 3Ø 4W system (Heaviest pcs).

⑤ Feed through tap boxes are required when the main incoming cables enter and exit at the same end of line up.

⑥ Module comes factory assembled for left hand side entry. For right hand side entry, bus bars and insulated supports must be moved at the other hole set, marked with an "R", before wall installation.

⑦ For optional lugs, please contact your Siemens sales representative.

# Meter Centres

## 240V Modular Meter Centres

*Selection*

- 240V modular meter centre is built for cold metering
- Load cables can exit from the top or the bottom of the stack
- Meter stack comes standard with knock-outs on the top tub end (see p. 2-15)<sup>③</sup>

**Basic Meter Stack** - Meter socket modules and front blank plates must be ordered separately

Main Service Voltage	Sub-service Voltage	Catalogue Number	Max. number of sub-service meter per stack <sup>①</sup>		Dimensions - Inches (mm)			Height - MOD	Weight - lbs.(kg)
			125A	200A	H	W	D		
120/240 1Ø3W	120/240 1Ø3W	<b>MMC1</b>	6	4	78 (1981)	14 (356)	7 <sup>1/4</sup> (184)	6	67 (30.4)
120/208 3Ø4W	120/208 3Ø4W	<b>MMC3</b>	6	4					67 (31.8)
120/208 3Ø4W	120/208 3Ø4W	<b>MMC3</b> (with QJ/QR sub-service breaker)	4	2					

**Complete Meter Stack<sup>①②</sup>** - Meter socket modules included

Main Service Voltage	Sub-service Voltage	Catalogue Number	Sub-service Meter Socket included	Dimensions - Inches (mm)			Height - MOD	Weight - lbs.(kg)
				H	W	D		
120/240 1Ø3W	120/240 1Ø3W	<b>MMC14-6125</b>	6 x MMS4-125	78 (1981)	14 (356)	7 <sup>1/4</sup> (184)	6	109 (49.6)
120/208 3Ø4W	120/208 3Ø4W	<b>MMC35-6125</b>	6 x MMS5-125					112 (50.9)



① Provision only, breakers not included  
 ② Complete meter stacks are factory balanced for ease of installation  
 ③ Blank top end is also available on demand. Contact your Siemens sales representative.

# Meter Centres

## 240V Modular Meter Centres

*Selection*

### Meter Socket Module<sup>①</sup>

Sub-service Voltage	Meter Socket Rating	Catalogue Number	Number of Jaws	Breaker Provision type	Phase Connection	Height		Weight - lbs.(kg)
						in. (mm)	MOD	
120/240 1Ø3W	125A	MMS4-125	4	BQ, BQH, HBQ, Q, QP, QPH, HQP	AB	8 <sup>7/8</sup> (225)	1	7 (3.2)
	200A	MMS4-200	4	EQ96XX	AB	13 <sup>5/16</sup> (338)	1.5	11 (5)
		MMS4-200QR <sup>④</sup>	4	QR2, QRH2, QR2H, HQR2				
120/208 3Ø4W	125A	MMS5-125	5 <sup>②</sup>	BQ, BQH, HBQ, Q, QP, QPH, HQP	AB <sup>③</sup>	8 <sup>7/8</sup> (225)	1	7 (3.2)
	200A	MMS5-200	5 <sup>②</sup>	EQ96XX	AB <sup>③</sup>	13 <sup>5/16</sup> (338)	1.5	11 (5)
		MMS5-200QR <sup>④</sup>	5 <sup>②</sup>	QR2, QRH2, QR2H, HQR2				
	100A	MMS7-100	7 <sup>②</sup>	BQ, BQH, HBQ, Q, QP, QPH, HQP	AB <sup>③</sup>	13 <sup>5/16</sup> (338)	1.5	10 (4.6)
	200A	MMS7-200QR <sup>④</sup>	7 <sup>②</sup>	QR2, QRH2, QR2H, HQR2 (3 phases)				

### Main Bus Connector Kit - Allows the connection of two meter stacks

Sub-service Voltage	Max. Ampere Rating	Catalogue Number	Use with Meter Module Type	Weight - lbs.(kg)	 <p><b>MBSS1-600</b></p>
120/240 1Ø3W	600A	MBSS1-600	MMC1 or MMC14-6125	3 (1.3)	
	1200A	MBSS1-1200		7 (3.18)	
120/208 3Ø4W	600A	MBSS3-600	MMC3 or MM35-6125	4 (1.82)	
	1200A	MBSS3-1200		10 (4.55)	

Meter Socket Modules	Cable lug size per phase - suitable for Al and Cu cables
MMS4-125	Load: (1) #14 AWG - 2/0 AWG
MMS4-200 MMS4-200QR MMS4-200QJ	Load: (1) #6 AWG - 250 Kcmil
MMS5-125	Load: (1) #14 AWG - 2/0 AWG
MMS5-200 MMS5-200QR MMS5-200QJ	Load: (1) #6 AWG - 250 Kcmil
MMS7-100	Load: (1) #14 AWG - 2/0 AWG
MMS7-200QR MMS7-200	Load: (1) #6 AWG - 250 Kcmil

① Provision only, breakers not included

② Meter socket modules with 5 and 7 jaws can be assembled in the same meter stack as long as the system is balanced.

③ MMS5-125 and MMS5-200 have AB phase connections by default. Phasing connections can be changed on the field to AC or BC to balance the load on the system.

④ Meter modules for QJ type breakers (MMS4-200QJ, MMS5-200QJ, MMS7-200) have been replaced by meter modules for QR type breakers.



# Meter Centres

## 240V Modular Meter Centres

*Selection*

**Sub-service Circuit Breakers** - Maximum interruption rating for 240V AC

- Mounting hardware for BQ breakers must be ordered separately (#8712-6, #8712-12, #8712-100, #8712-200)

Ampere Rating	Poles	Catalogue Number					
		KAIC = 10kA		KAIC = 22kA		KAIC = 65kA	
		Plug-in	Bolt-on	Plug-in	Bolt-on	Plug-in	Bolt-on
60A <sup>Ⓞ</sup>	2	Q260	BQ2B060	Q260H	BQ2B060H	Q260HH	HB2B060
	3	Q360	BQ3B060	Q360H	BQ3B060H	Q360HH	HB3B060
70A	2	Q270	BQ2B070	Q270H	BQ2B070H	Q270HH	HB2B070
	3	Q370	BQ3B070	Q370H	BQ3B070H	Q370HH	HB3B070
80A	2	Q280	BQ2B080	Q280H	BQ2B080H	Q280HH	HB2B080
	3	Q380	BQ3B080	Q380H	BQ3B080H	Q380HH	HB3B080
90A	2	Q290	BQ2B090	Q290H	BQ2B090H	Q290HH	HB2B090
	3	Q390	BQ3B090	Q390H	BQ3B090H	Q390HH	HB3B090
100A	2	Q2100	BQ2B100	Q2100H or EQ9675	BQ2B100H	Q2100HH	HB2B100
	3	Q3100	BQ3B100	Q3100H	BQ3B100H	Q3100HH	HB3B100
110A	2	Q2110	BQ2B110	Q2110H	BQ2B110H	Q2110HH	N/A
	3	Q3110	N/A	Q3110H	N/A	Q3110HH	N/A
125A	2	Q2125	BQ2B125	Q2125H or EQ9677	BQ2B125H	Q2125HH	HQR23B125
	3	N/A	QR23B125	N/A	QRH23B125	N/A	HQR23B125
150A	2	EQ9683	QR22B150	EQ9683	QRH22B150	N/A	HQR22B150
	3	N/A	QR23B150	N/A	QRH23B150	N/A	HQR23B150
175A	2	N/A	QR22B175	EQ9684	QRH22B175	N/A	HQR22B175
	3	N/A	QR23B175	N/A	QRH23B175	N/A	HQR23B175
200A	2	EQ9685	QR22B200	EQ9685	QRH22B200	N/A	HQR22B200
	3	N/A	QR23B200	N/A	QRH23B200	N/A	HQR23B200

**Note:** Low amperage circuit breakers (15-60A) available with installation of connector kit #MSMK-50

**Corner Elbow Modules** - Permit continuation from stack to stack around corners

System Voltage	Ampere Rating	Catalogue Number	Dimensions - Inches (mm)			Weight - lbs.(kg)
			H	W	D	

**Inside Elbow Modules**

120/240 1Ø3W	600	MEL1-IN-6	16 (406)	12 (304)	7 1/4 (184)	45 (20)
	1200	MEL1-IN-12				
120/208 3Ø4W	600	MEL3-IN-6				50 (23)
	1200	MEL3-IN-12				

**Outside Elbow Modules**

120/240 1Ø3W	600	MEL1-OUT-6	16 (406)	12 (304)	7 1/4 (184)	45 (20)
	1200	MEL1-OUT-12				
120/208 3Ø4W	600	MEL3-OUT-6				50 (23)
	1200	MEL3-OUT-12				

**Note:** To connect a Tap Box to an Elbow, order **MTBELK6** or **MTBELK12**. Connection from feed-through tap box 1200A to an elbow is not possible.

**Inside**

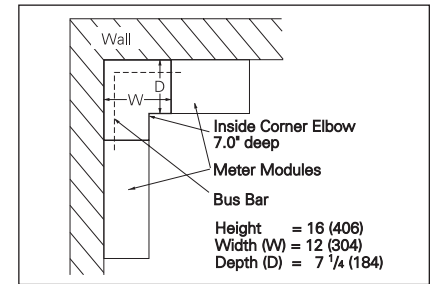

**Outside**

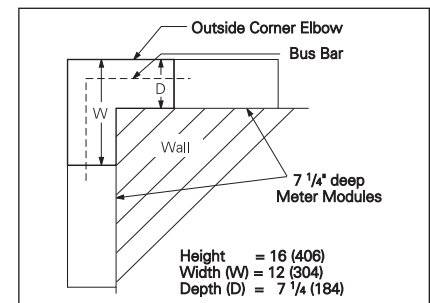

<sup>Ⓞ</sup> Connector kit #MSMK-50 is required for 60A breaker installation.

# Meter Centres

## 240V Modular Meter Centres

Selection

### Accessories

METER CENTRES 2

Catalogue Number	Description	Content
MBHP-2	Blank meter socket filler plate required to cover empty space, each steel plate has a dimension of 4.3 x 14.1 in.	2 half plates (1 MOD = 1 x MBHP-2)
MLTB-L2750	Alternative lug kit for 600A standard tap boxes	4 lugs 1/0 AWG - 750 Kcmil Al/Cu
MTBK12	Connection adaptor kit for tap box MLTB1-1200 or MLTB3-1200 when used for output with an odd number of meter stacks	4 connector spacers and hardware
MTRK-64	Wall mounting rail of 64 in., meter stack is supplied with embossed hooks for this mounting rail system	1 wall mounting track 64"
MTBELK6	Bus bar kit to connect a 600A standard or feed-through tap box via a 600A corner elbow	4 Bus Bars and hardware
MTBELK12	Bus bar kit to connect a 1200A standard tap box via a 1200A corner elbow	8 Bus bars and hardware
MSSR	Meter sealing ring	1 meter ring
MUJP-5	Jumper bar 200A max, 5 jaws, to jump a metering position when the meter has temporarily been removed	2 jumper bars
MUJP-7	Jumper bar 200A max, 7 jaws, to jump a metering position when the meter has temporarily been removed	3 jumper bars
SEALSC1	Sealing screw kit	25 sealing screws
SFLK-200	Subfeed lug kit 200A max.	4 lugs 6 AWG - 300 Kcmil Al/Cu
8712-6	BQ breaker mounting hardware	6 screws
8712-12	BQ breaker mounting hardware	12 screws
8712-100	BQ breaker mounting hardware	100 screws
8712-200	BQ breaker mounting hardware	200 screws



MBHP-2

### Replacement cover for Meter Socket Modules

Catalogue Number	Description	Content
MC4-125	125A 4 & 5-jaw front cover plate QP & BQ breakers	1 cover plate 1 sealing ring 1 sealing screw
MC4-200	200A 4 & 5-jaw front cover plate QP & BQ breakers	
MC4-200QR	200A 4 & 5-jaw front cover plate QR breaker	
MC4-200QJ	200A 4 & 5-jaw front cover plate QJ breaker	
MC7-100	100A 7-jaw front cover plate QP & BQ breakers	
MC7-200QR	200A 7-jaw front cover plate QR breaker	
MC7-200	200A 7-jaw front cover plate QJ breaker	



MC4-125

### Tap Box Modification Kits

Catalogue Number	Description	Content
MLTB-AP	Al. plate punched for standard tap boxes and MLTB 600FT	1 tap box tub end
MLTB-AU	Al. plate unpunched for standard tap boxes and MLTB 600FT	
MLTB-AUFT	Al. plate unpunched for Feed-Through Tap Box 1200A	
MLTB-FP	Fiber plate punched for standard tap boxes and MLTB 600FT	
MLTB-FPFT	Fiber plate punched for Feed-Through Tap Box 1200A	
MLTB-FU	Fiber plate unpunched for standard tap boxes and MLTB 600FT	
MLTB-FUFT	Fiber plate unpunched for Feed-Through Tap Box 1200A	

**Note:** Multi-stack grounding is accomplished by running a bare wire through the factory installed lay-in lugs in the bottom of each stack. No grounding kit is required except when an elbow module is used.

# Meter Centres

## 240V Modular Meter Centres

Selection

### Configurations with switch

With Switch

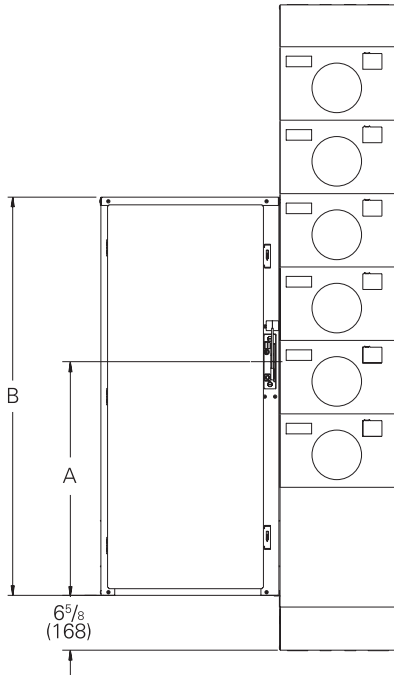

With Transition Box and Switch

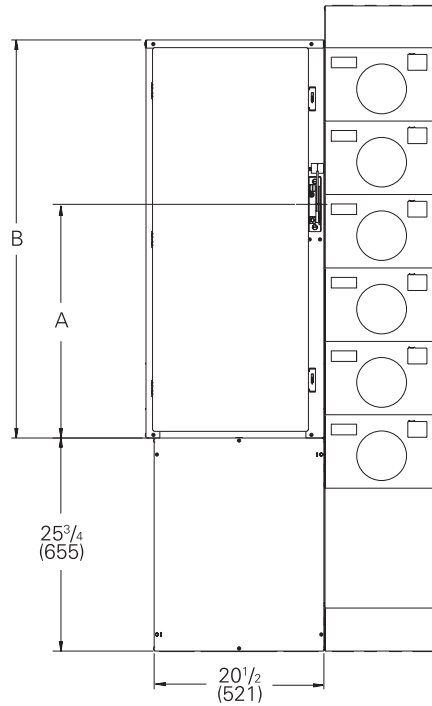

### Configurations with Standard Tap Box or Transition Box

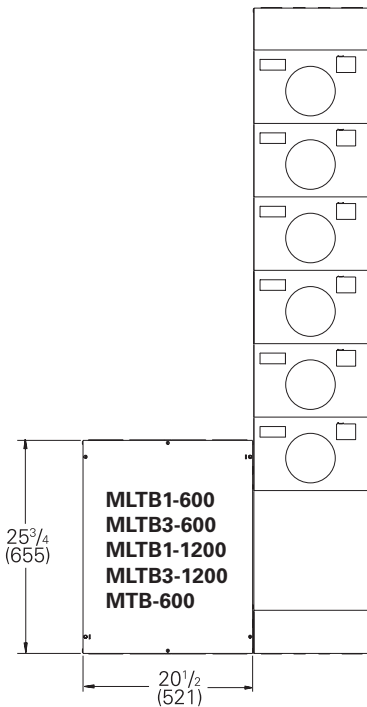

### Standard Tap Box connections

MLTB1-600

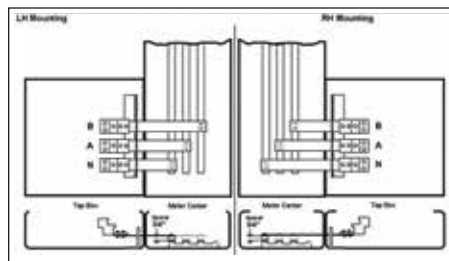

MLTB3-600

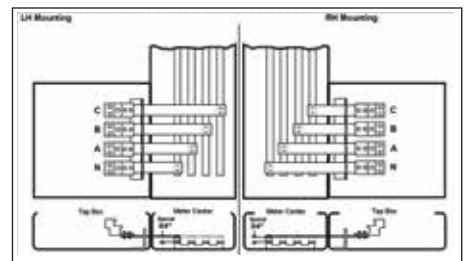

MLTB1-1200

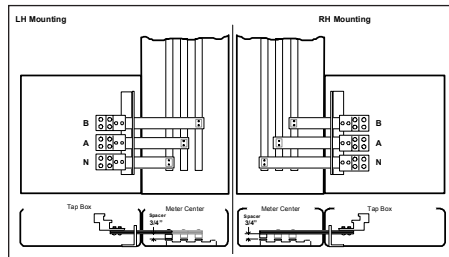

MLTB3-1200

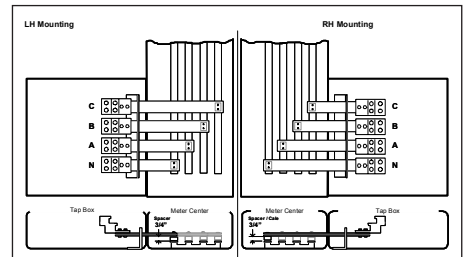

# Meter Centres

## 240V Modular Meter Centres

*Selection*

Configurations with feed through Tap Box 600A

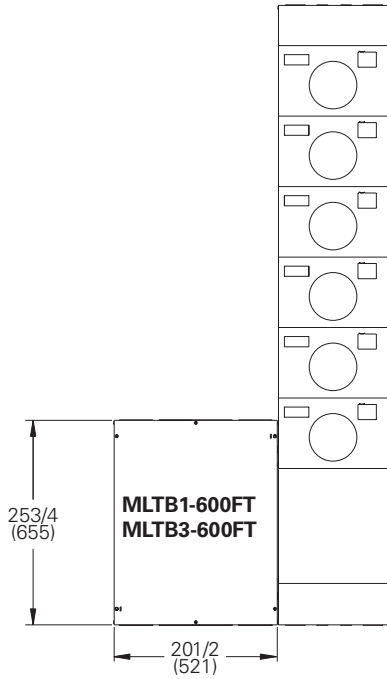

MLTB1-600FT

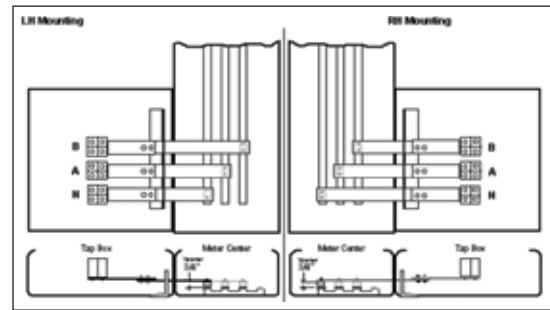

MLTB3-600FT

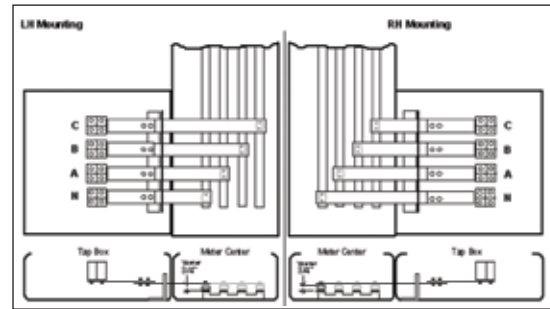

Configurations with feed through Tap Box 1200A

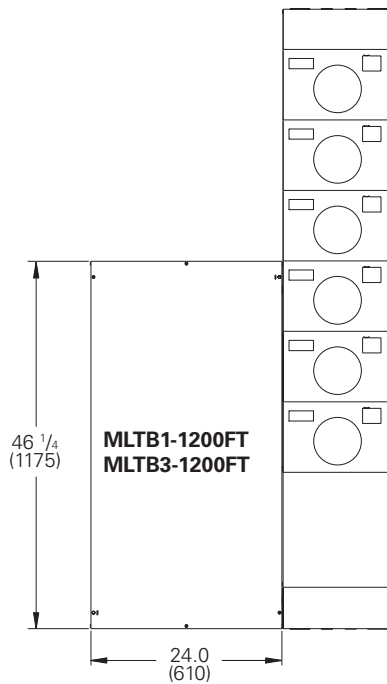

MLTB1-1200FT

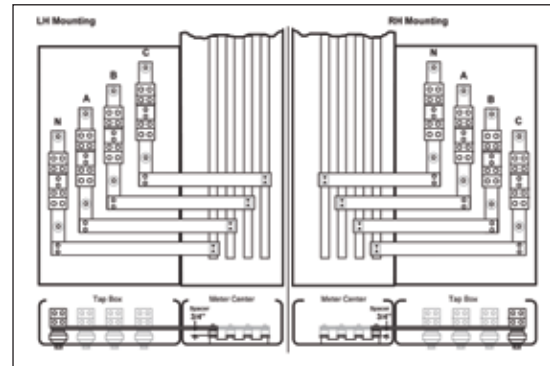

MLTB3-1200FT

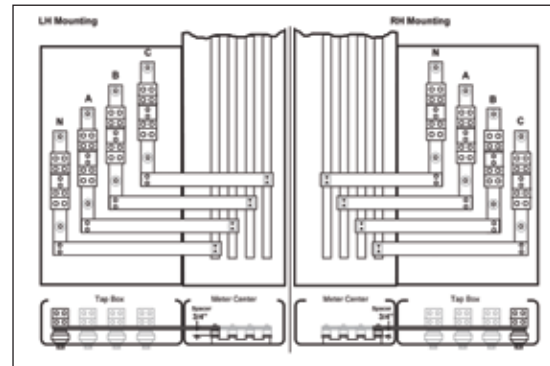

Note: For Feed-Through Tap Box 1200A, standard assembly is for left hand mounting. For right hand mounting, bus bar and insulated support must be moved at the other hole set (marked with an "R") before wall installation.

# Meter Centres

## 240V Modular Meter Centres

*Selection*

Meter Stack Mounting Dimensions - Inches (mm)

MMC1  
MMC3

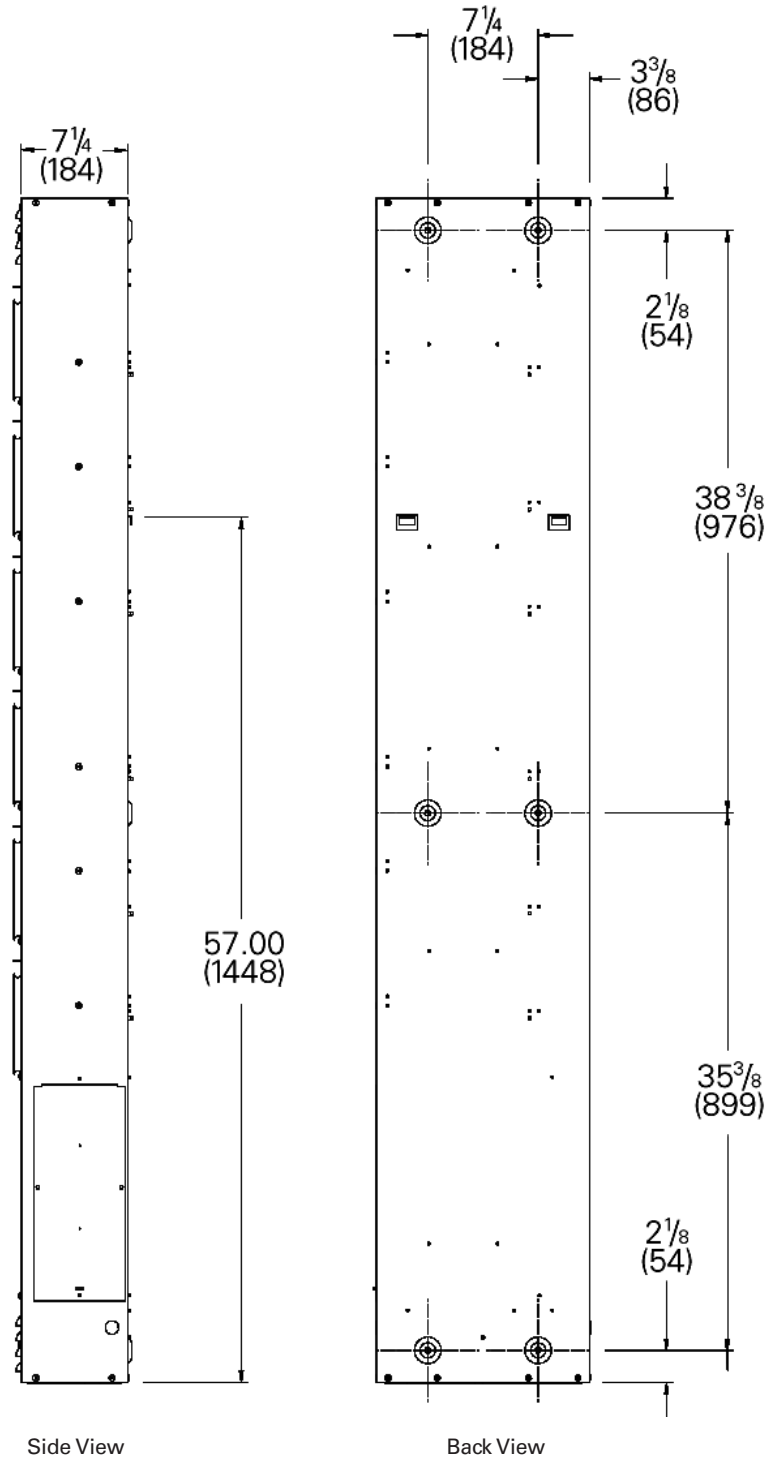

# Meter Centres

## 240V Modular Meter Centres

*Selection*

Meter Modules Dimensions - Inches (mm)

Meter Socket Module:  
**MMS7-100**

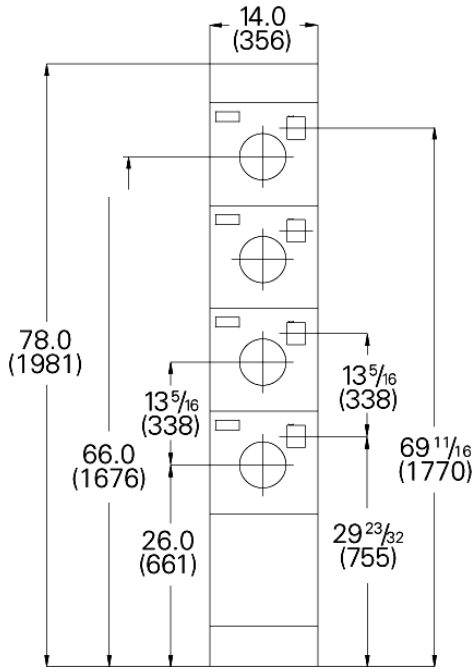

Meter Socket Modules:  
**MMS4-125**  
**MMS5-125**

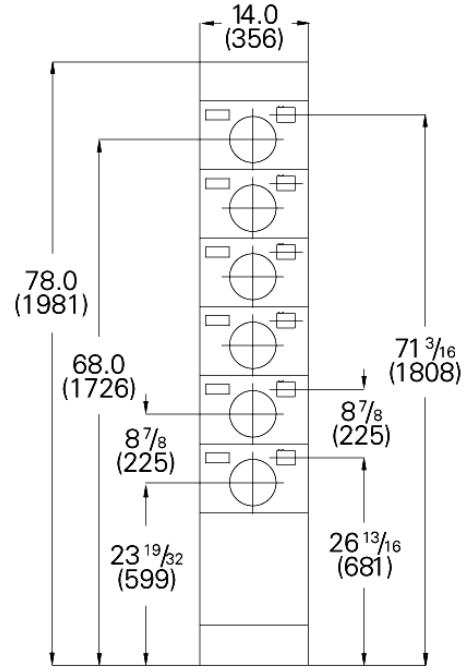

Meter Socket Modules:  
**MMS4-200**  
**MMS5-200**  
**MMS4-200QR**  
**MMS5-200QR**

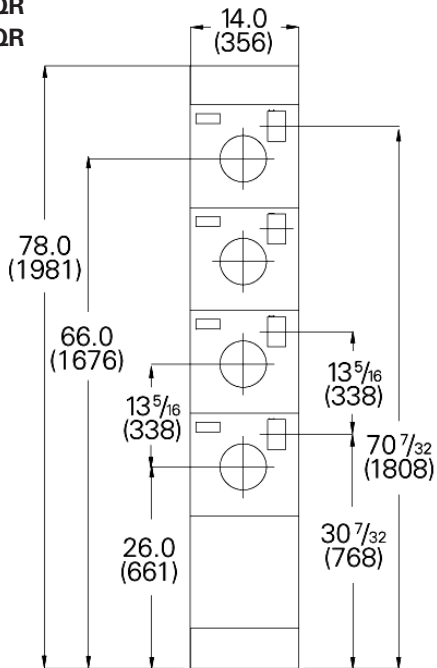

Meter Socket Module:  
**MMS7-200QR**

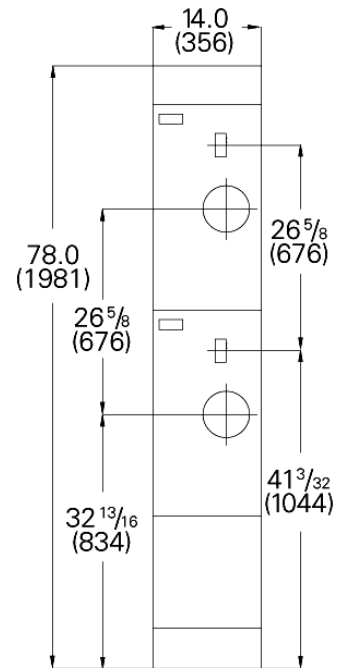

# Meter Centres

## 240V Modular Meter Centres

Selection

Knock Out Data for tap boxes tub end - Inches (mm)

B	1 <sup>1</sup> / <sub>4</sub> - 1 <sup>1</sup> / <sub>2</sub> - 2
A	3 - 3 <sup>1</sup> / <sub>2</sub>
Ref.	K.O. Trade Size

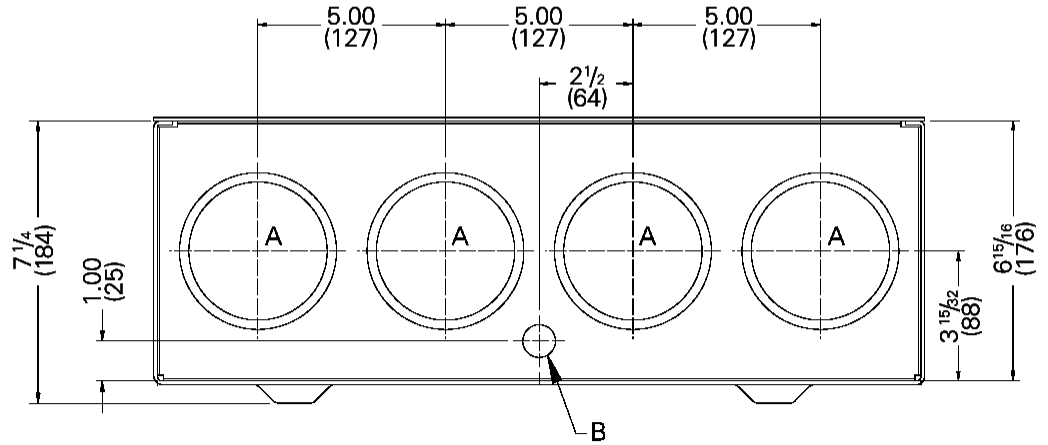

Knock Out Data for top meter stack tub end - Inches (mm)

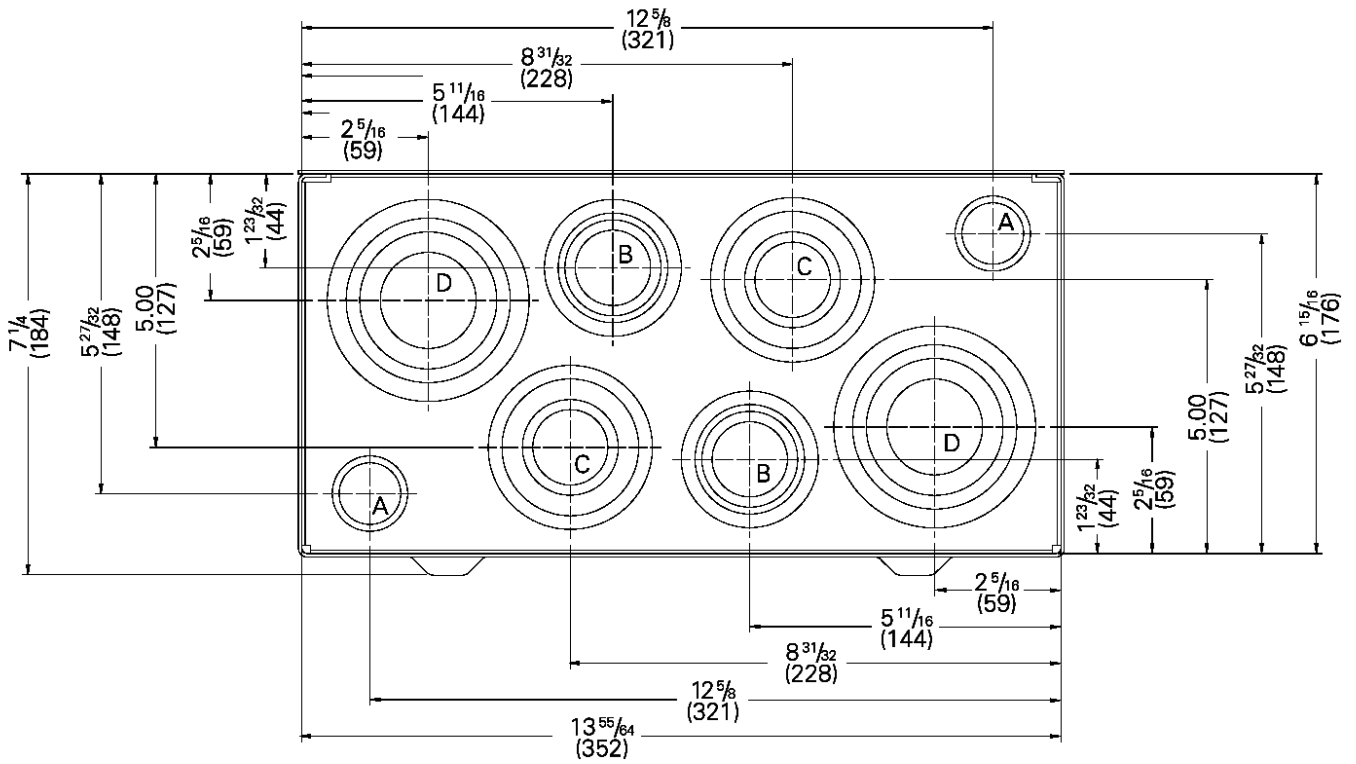

1 <sup>1</sup> / <sub>4</sub> - 2 - 2 <sup>1</sup> / <sub>2</sub> - 3	D
1 - 1 <sup>1</sup> / <sub>4</sub> - 2 - 2 <sup>1</sup> / <sub>2</sub>	C
1 - 1 <sup>1</sup> / <sub>4</sub> - 1 <sup>1</sup> / <sub>2</sub> - 2	B
3/4 - 1	A
K.O. Trade Size	Ref.

# Meter Centres

## 240V Modular Meter Centres

Reference

Layout example - Reference only

System: 120/240V 1Ph 3W, 10kA

### Dimension of each stack:

Height: 78" (1981mm)

Width: 14" (356mm)

Depth: 7 1/4" (184mm)

Height of the modules: ( 24 Modules)

125A Module: 8 7/8" (225.5mm)

Overall Width: 76 1/2" (1945mm)

METER CENTRES 2

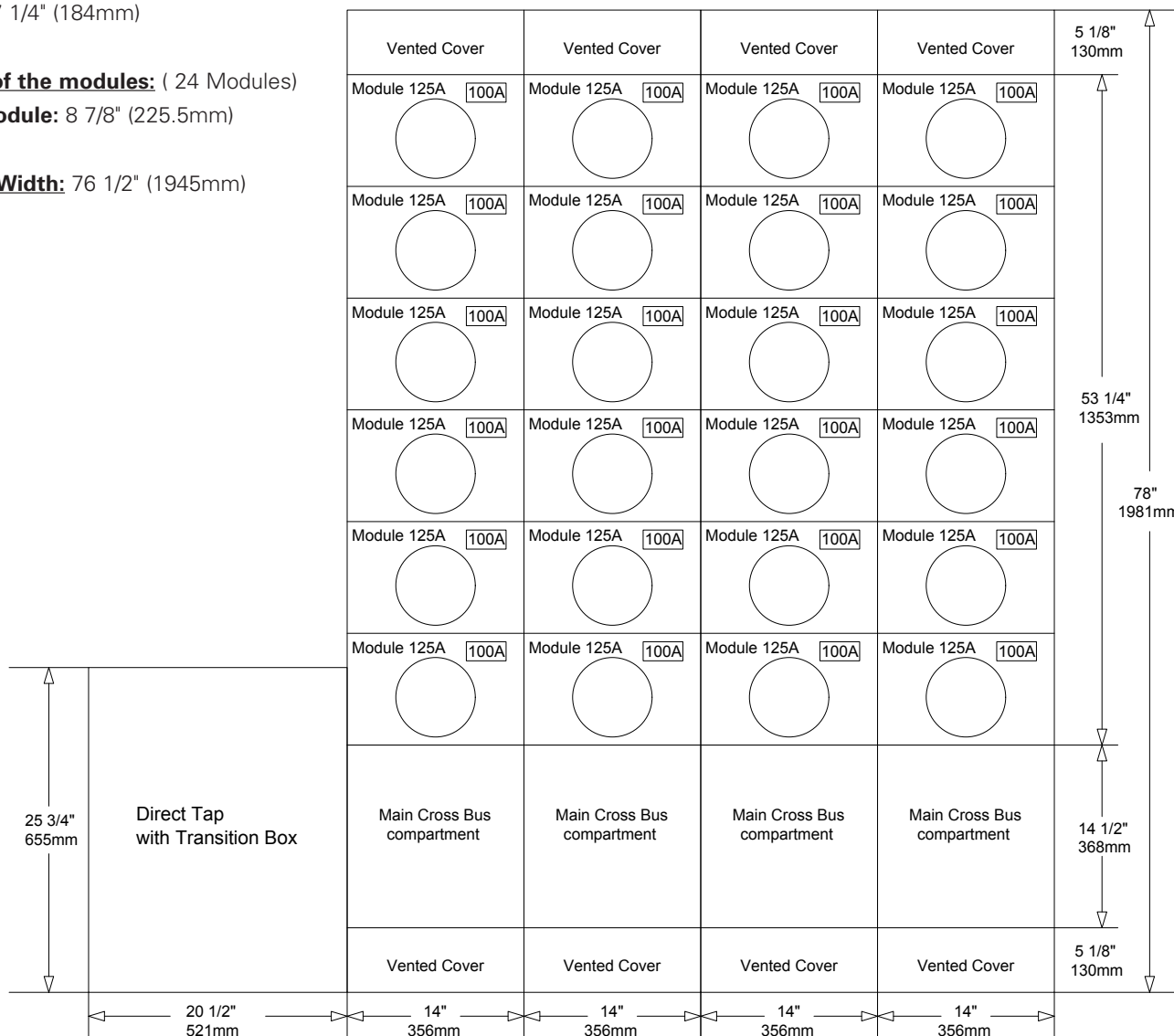



# Meter Centres

## 600Y/347V Meter Centre

General

### General Specifications

Siemens 600Y/347V metering line offers an ideal solution for restricted space projects. This metering solution for 600Y/347V applications has been designed in Canada based on contractors' feedback. Each meter stack houses features designed with the contractor in mind, to maximize productivity and minimize labour costs

### Voltage

600Y/347V AC

### Amperage

Horizontal bus bars rated for 1200A max.  
Vertical bus bars rated for 800A max.  
Meter socket rated for 200A max.

### Short Circuit rating

42,000A RMS symmetrical @ 600V max.  
when protected by 1200A maximum HRC class L type fuse

### Standard

CSA: C22.2 No. 229-M1988.  
Certified under file #153416

### Service

3-phase 4-wire 600Y/347Vac

### Enclosure

Type 1 enclosure. Meter stack comes standard with dripshield and blank end walls (no knockout). Meter stack enclosure, barriers and end plates are manufactured of galvanized steel. Front covers are fabricated of phosphatized steel finished with ASA 61 light grey paint.

### Meter Socket Jaws

Meter socket jaws consist of tin plated copper with steel spring reinforced clips for reliable contact pressure. Positive alignment of jaws and stabs is assured by bus straps factory installed.

### Sub-Service Breaker

High performance bolt-on circuit breakers can be selected to address site requirements from 70 to 200A. Interrupting ratings up to 25kA combine thermal and magnetic trip elements. Series rating is also available for approved combination up to 42kA when protected by 1200A maximum HRC class L type fuse.

### Breaker Provisions

Each 600V meter stack has provision for four 3-pole 200A max bolt-on type FXD6/HFXD6 circuit breaker. Non-interchangeable trip unit breakers must be used for this application. Generous gutter space allows for wiring for top or bottom of the meter module. All sub-service breaker mounting hardware is provided with each meter stack.

### Neutral & Ground Provisions

Each stack includes neutral & ground provisions.

Connectors	Wire size
Neutral	#6 @ 350MCM #14 @ 2
Ground	#6 @ 250MCM



### Features

- Robust and compact enclosure standard with dripshield
- Sturdy bussing connections providing durable support for each sub-service breaker
- Breaker and bus bar protection allowing screws recuperation
- Provision to padlock sub-service breaker in the "off" position
- Large wireway separated from meter area for easier connections.
- Trouble-free access to horizontal bars and easy access to cabling area
- Reliable and simple busbar to busbar connections

# Meter Centres

## 600Y/347V Meter Centre

*Selection*

600Y/347V Meter Stack<sup>①②</sup> – 2 versions available

- Cold metering
- Includes 4 meter sockets 7-jaw rated for 200A max
- Load cables can exit enclosure at top and/or bottom
- Removable bottom plate to facilitate drilling holes for cable entry
- Horizontal main bus bar rated for 1200A max
- Uses Siemens breakers 200A max, type FXD6 and HFXD6 only
- Includes provisions for 4 sub-service breakers, 200A max.
- Type 1 enclosure, standard with dripshield and blank end walls
- Mounting hardware for 4 breaker is included in each stack
- "HQ" version has hinges for wireway covers

Main service voltage	Sub-service voltage	Catalogue number	Meter socket rating and number of jaws	Number of sub-service	Circuit breaker Type	Vertical Bus Bar rating (Amp)	Overall dimensions in inches (mm)			Weight - lbs (kg)
							H	W	D	
600Y/347V 3Ø4W	600Y/347V 3Ø4W	MMC37-42006	200A 7-Jaw	4	FXD6, HFXD6	800	76 <sup>1</sup> / <sub>4</sub> (1937)	20 <sup>5</sup> / <sub>8</sub> (524)	13 <sup>15</sup> / <sub>16</sub> (354)	220 (100)
		MMC37-42006HQ								



MMC37-42006



MMC37-42006HQ

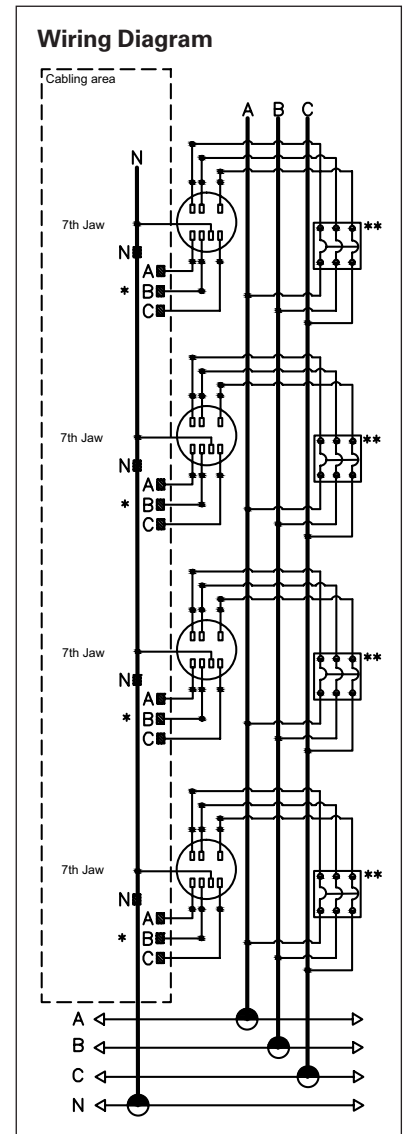

① Sub-service breakers are not to exceed meter socket rating  
 ② Breaker provision only, breaker must be ordered separately. Breaker mounting hardware included with 600Y/347V meter stack.

# Meter Centres

## 600Y/347V Meter Centre

Accessories

### Sub-service Circuit Breakers<sup>①</sup>

- Assembled circuit breaker without lugs (lugs not required for this application)
- Non-interchangeable trip only
- Breaker mounting hardware provided with meter stack
- Additional information on breaker available in section 5 page 5-24

Amperage Rating	Number of Poles	Max. interrupting rating for 600Y/347V	
		22 kA	25 kA
		Catalogue Number	Catalogue Number
70A	3	FXD63B070	HFXD63B070
80A	3	FXD63B080	HFXD63B080
90A	3	FXD63B090	HFXD63B090
100A	3	FXD63B100	HFXD63B100
125A	3	FXD63B125	HFXD63B125
150A	3	FXD63B150	HFXD63B150
175A	3	FXD63B175	HFXD63B175
200A	3	FXD63B200	HFXD63B200

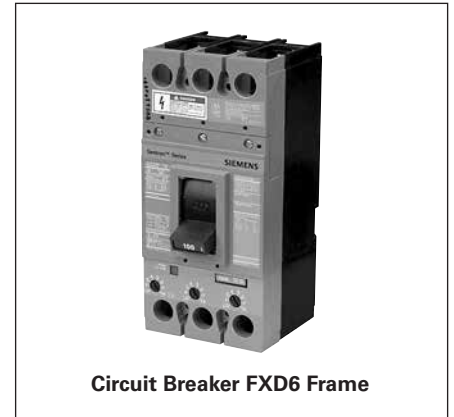

2  
METER  
CENTRES

### Standard Tap Boxes

- "IN" lugs included
- Suitable for left and right hand side entry (standard configuration is left hand side)

Main service	Amperage Rating (Amp)	Catalogue Number	Cable lug size per phase - suitable for Al and Cu cables	Overall Dimensions - Inches (mm)			Weight - lbs (kg)
				H	W	D	
600Y/347V 3Ø4W	600	MLTB3-6006	(1) 1/0 @ 750MCM Cu/Al	25 <sup>1/8</sup> (638)	27 <sup>1/4</sup> (692)	13 <sup>15/16</sup> (354)	68 (30.8)
	1200	MLTB3-12006	(1) 1/0 @ 750MCM Cu/Al	25 <sup>1/8</sup> (638)	27 <sup>1/4</sup> (692)	13 <sup>15/16</sup> (354)	70 (31.8)

### Feed Through Tap Boxes

- "IN" and "OUT" lugs included
- Feed Through tap boxes are suitable for left and right hand side entry

Main service	Amperage Rating (Amp)	Catalogue Number	Cable lug size per phase - suitable for Al. And Cu cables	Overall Dimensions - Inches (mm)			Weight - lbs (kg)
				H	W	D	
600Y/347V 3Ø4W	600	MLTB3-600FT6	(4) 250 @ 750 MCM Cu/Al or (8) 3/0 @ 250 MCM Cu/AL	25 <sup>1/8</sup> (638)	27 <sup>1/4</sup> (692)	13 <sup>15/16</sup> (354)	74 (33.6)
	1200	MLTB3-1200FT6	(8) 1/0 @ 750 MCM Cu/Al	50 <sup>5/8</sup> (1285)	27 <sup>1/4</sup> (692)	13 <sup>15/16</sup> (354)	145 (65.8)



<sup>①</sup> Breaker mounting hardware kit included with 600V meter stack.

# Meter Centres

## 600Y/347V Meter Centre

*Selection*

### Close coupled option with Siemens SMP switchboard

- SMP must have main breaker at top of the section
- Sill channel optional
- Close coupled option available for 1200A only
- Main bus connector kit required to connect stack with SMP. Main bus kit needs 15" high of space at the bottom of the SMP distribution section. In SMP with Hydro compartment, only 7.5" available for distribution breakers, just below the Hydro compartment.
- Suitable for left and right hand side entry based on main bus connector kit selection (standard configuration is left hand side entry as displayed below)

### Main Bus Connector Kit

- Kit includes optional meter centre sill channel

Main service Voltage	Amperage Rating (Amp)	Catalogue Number	Description	Weight in lbs (kg)
600Y/347V 3Ø4W	1200	<b>MBSMP3-12006</b>	SMP Connector kit 1200A Max	12 (5.4)
	1200	<b>MBSMP3-1200G</b>	SMP Connector kit 1200A Max (left)	12 (5.4)

Meter centre MMC37-42006 with bus bar joining kit MBSMP3-12006 (where Meter Centre is on the right of the SMP) and with MBSMP3-12006G (where Meter Centre is on the left of the SMP) – Inches (mm)

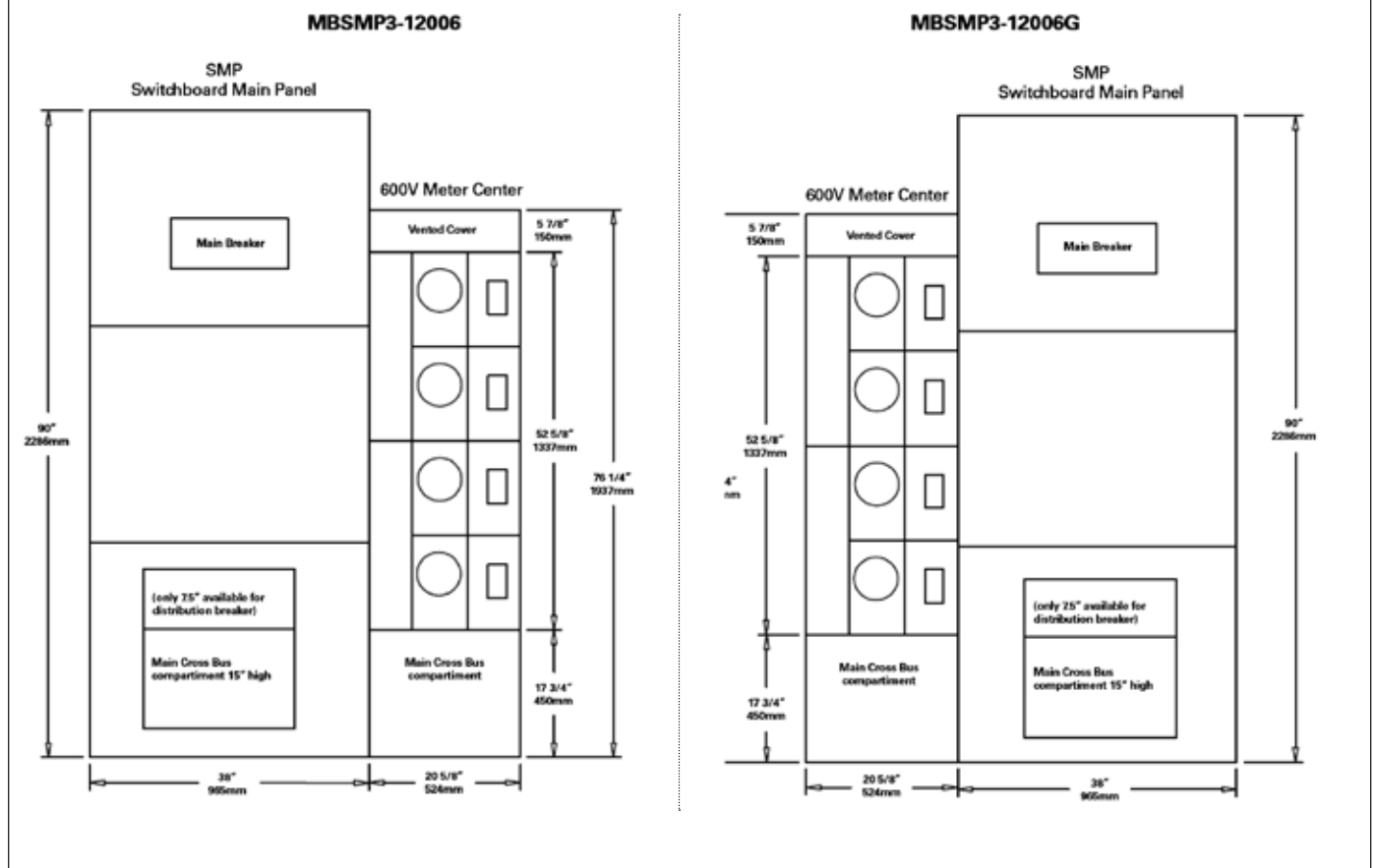

# Meter Centres

## 600Y/347V Meter Centre

Accessories

### Main Bus Link Connector Kits

- Main Bus Link Connector Kits are required for each additional stack when joining two or more meter stacks.
- The first stack installation does not require bus links when installed with a tap box (standard or Feed through). The tap box is supplied with main service lugs and bus bar link connectors.

Main service	Amperage Rating	Catalogue Number	Description	Weight - lbs (kg)
600Y/347V 3Ø4W	600	<b>MBSS3-6006</b>	Stack to stack connector kit 600A	2 (0.9)
	1200	<b>MBSS3-12006</b>	Stack to stack connector kit 1200A	4 (1.8)



### Inside Elbow Modules

- Allow the continuation from stack to stack around wall corners.
- Can be mounted on the left and right hand side of the meter centre.

Main service	Amperage Rating	Catalogue Number	Overall Dimensions - Inches (mm)			Weight - lbs (kg)
			H	W	D	
600Y/347V 3Ø4W	600	<b>MEL3-IN-6006</b>	17 <sup>1/2</sup> (406)	20 <sup>1/2</sup> (521)	13 <sup>1/2</sup> (343)	65 (29.5)
	1200	<b>MEL3-IN-12006</b>	17 <sup>1/2</sup> (406)	20 <sup>1/2</sup> (521)	13 <sup>1/2</sup> (343)	75 (34.0)

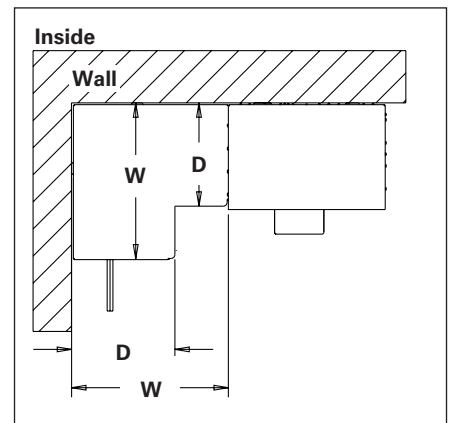

Left mounting shown. Can be mounted on the right side of the meter stack if needed.

### Accessories

Catalogue Number	Description	Content
<b>SFLK-2006</b>	Branch sub-feed lug kit, 600V	4 lugs
<b>MSSR</b>	Meter sealing ring	1 meter ring
<b>MUJP-7</b>	Jumper bars 7 jaws 200A	3 jumper bars
<b>MBP2006</b>	Blank meter plate covering meter socket and breaker provision	1 blank plate



### Replacement Parts

Catalogue Number	Description	Content
<b>MC7-200WS</b>	Repl Front cover wiring section	1 replacement plate and mounting hardware
<b>MC7-200WSHQ</b>	Repl Front cover wiring section for HQ version	
<b>MC7-200FD6</b>	Repl Front cover breaker section	
<b>MC7-2006TC</b>	Repl Top cover plate	
<b>MC7-2006BC</b>	Repl Bottom cover plate	
<b>MC7-2006AP</b>	Repl Access plate	
<b>MC7-200600</b>	Repl Front meter socket cover	
<b>SCR-6006</b>	Repl screws Stack to stack conn kit 600A	12 carriage bolt screws, washers & nuts.
<b>SCR-12006</b>	Repl screws Stack to stack conn kit 1200A	4 regular screws & washers
<b>SCRFXD6</b>	Repl breaker mounting screws	6 allen key type screws & washers. 2 long screws for breaker support

# Meter Centres

## 600Y/347V Meter Centre

*Selection*

Configuration with standard Tap Box - Inches (mm)

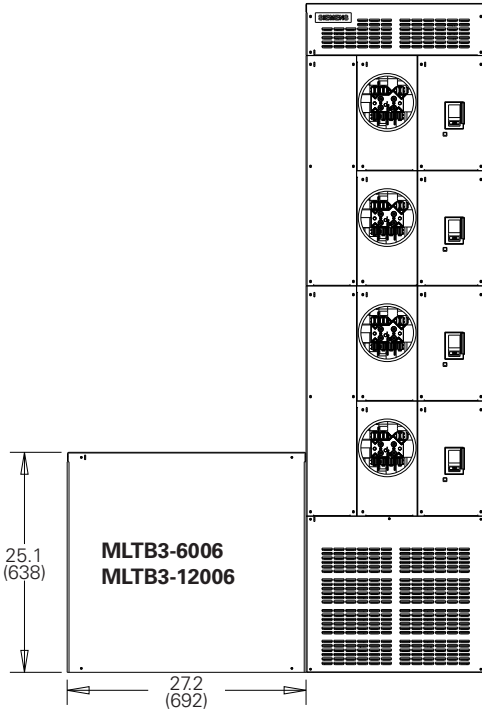

### Standard tap box connections

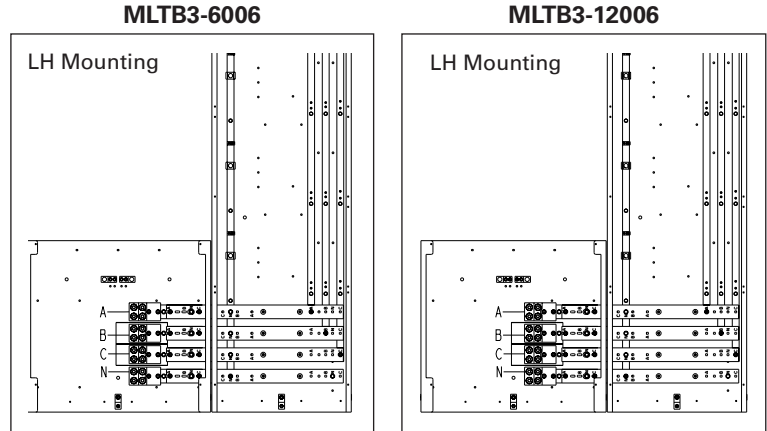

Note: Standard tap box can be mounted on the right hand side of the meter stack if needed.

Configuration with feed-through tap box 600A - Inches (mm)

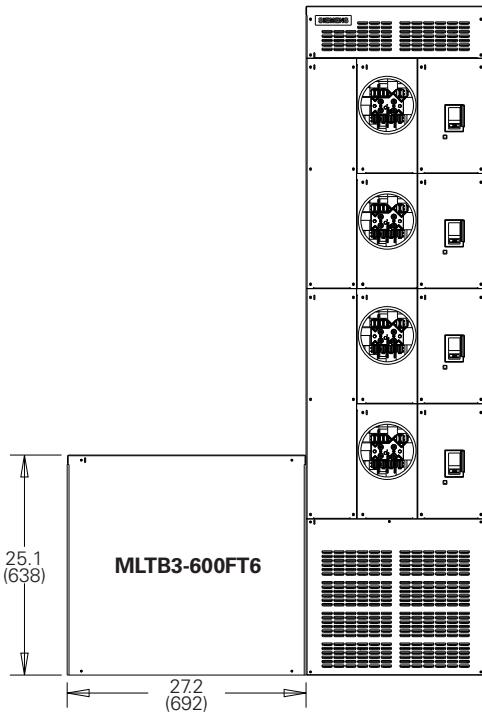

### 600A feed-through tap box connections

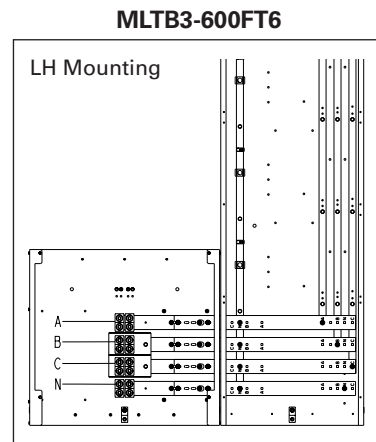

Note: 600A Feed-through tap box can be mounted on the right hand side of the meter stack if needed.

# Meter Centres

## 600V/347V Meter Centre

*Selection*

Configuration with feed-through tap box 1200A - Inches (mm)

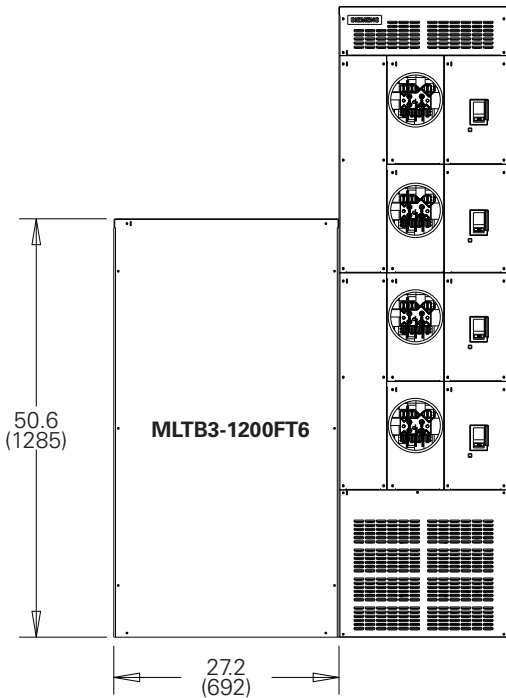

### 1200A feed-through tap box connections

#### MLTB3-1200FT6

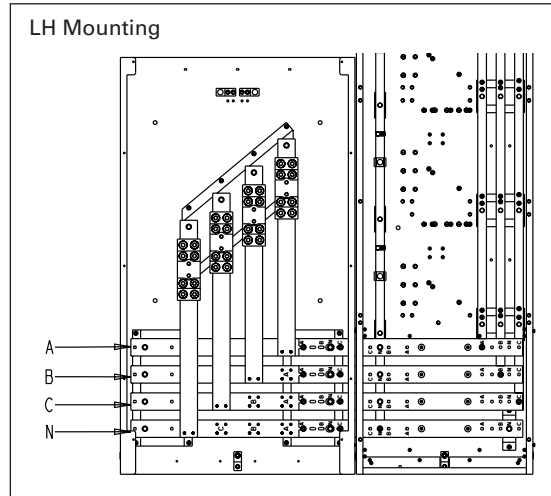

Note: 1200A feed-through tap box can be mounted on the right-hand side of the meter stack if needed.

### Bottom plate for 600V Meter stack - Inches (mm)

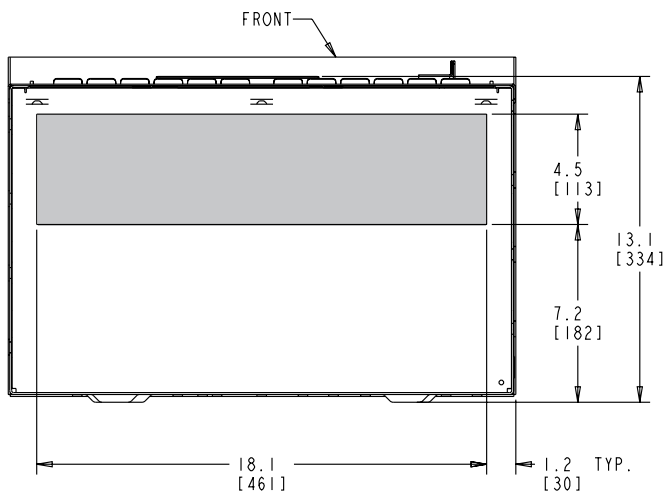

 Section can be easily removed to allow contractor to drill entry hole outside the equipment.

# Meter Centres

## 600Y/347V Meter Centre

*Selection*

### 600Y/347V Meter stack dimensions

**2**  
METER CENTRES

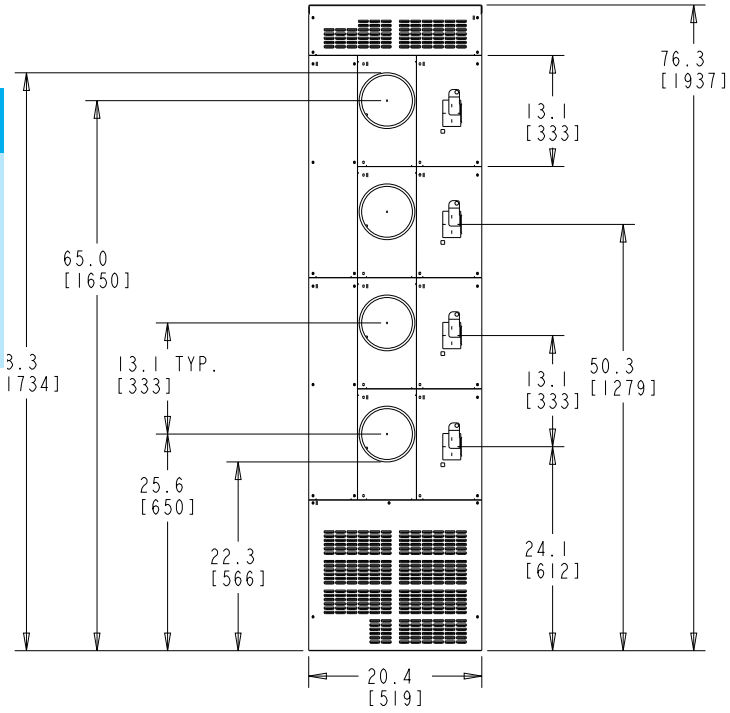

**Front View**

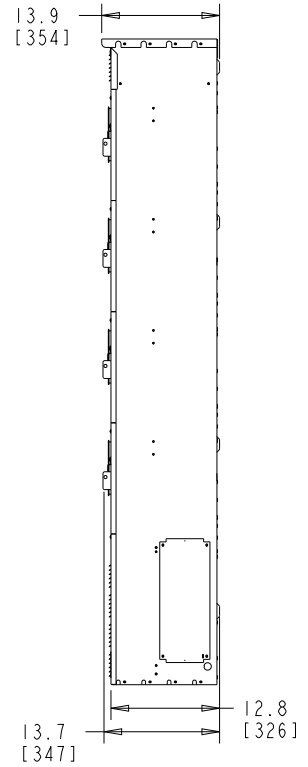

**Side View**

### 600Y/347V Meter stack mounting dimensions

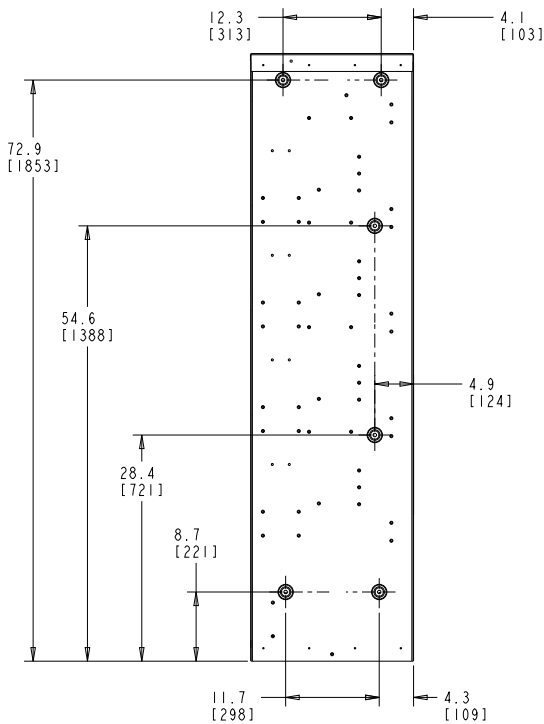

**Back View**



# Meter Centres

## 600Y/347V Meter Centre

Diagrams

### 600Y/347V Meter stack close coupled with SMP dimensions

Meter MMC37-42006 with bus bar joining kit MBSMP3-12006 where Meter Centre is on the right of the SMP - Inches(mm)

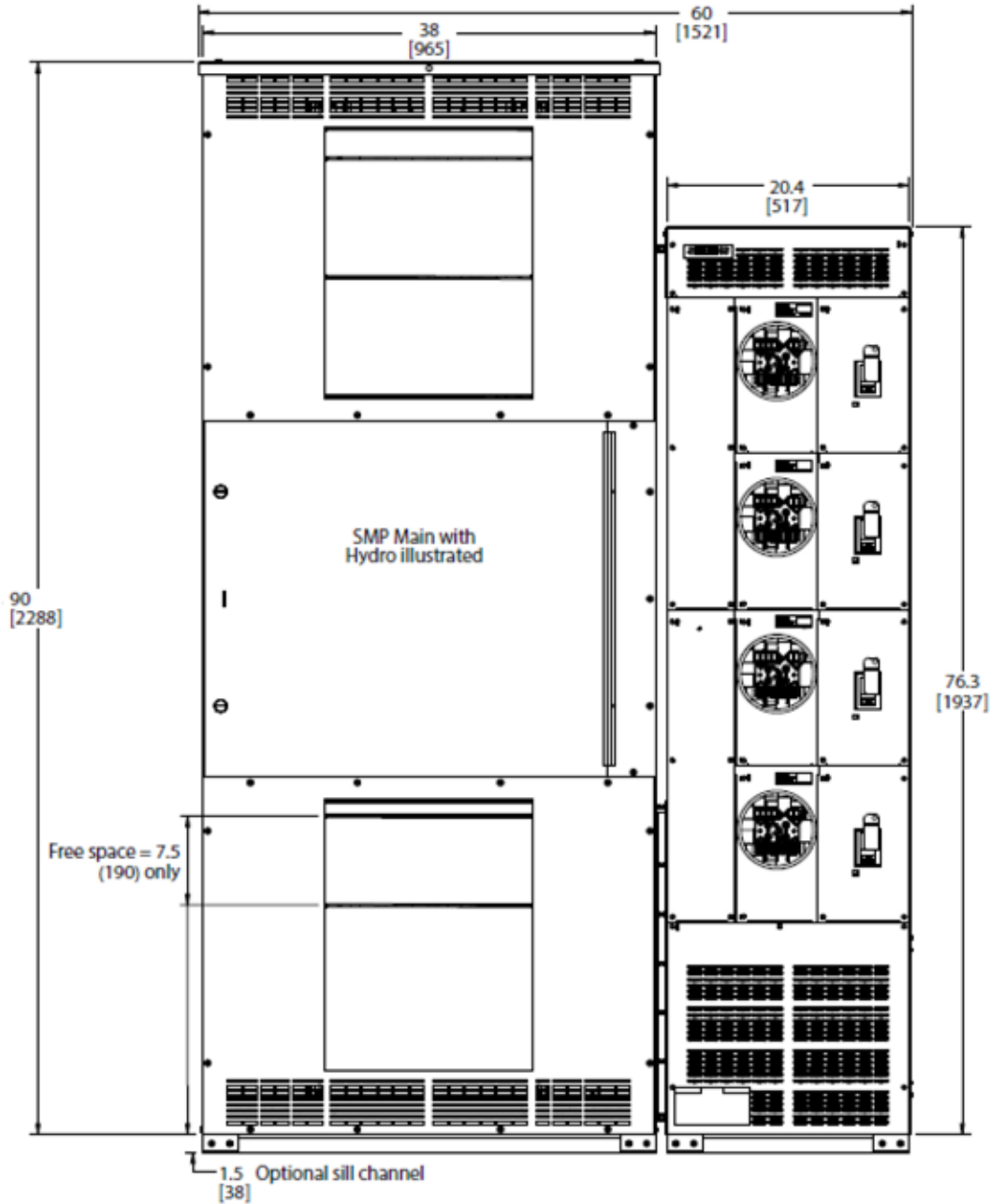

# Meter Centres

## 600Y/347V Meter Centre

Reference

Layout example - Reference only

System: 1200A, 600Y/347V 3Ph 4W, 42kA

### Dimension of each stack:

Height: 76 1/4" (1937mm)

Width: 20 5/8" (524mm)

Depth: 12 7/8" (326mm)

### Height of the modules:

Module: 13 1/8" (333mm)

Overall Width: 1740mm

METER CENTRES 2

