

## IEC Contactors and Starters



### 1.1 XT IEC Power Control

Product Overview .....	V5-T1-2
Relays and Timers .....	V5-T1-3
Miniature Controls .....	V5-T1-18
Contactors and Starters .....	V5-T1-35
Thermal Overload Relays .....	V5-T1-128
C440/XT Electronic Overload Relay .....	V5-T1-141
Manual Motor Protectors .....	V5-T1-157
Combination Motor Controllers .....	V5-T1-193
XT Electronic Manual Motor Protector .....	V5-T1-216
Reference Data .....	V5-T1-229



## Contents

<i>Description</i>	<i>Page</i>
Relays and Timers . . . . .	<b>V5-T1-3</b>
Miniature Controls . . . . .	<b>V5-T1-18</b>
Contactors and Starters . . . . .	<b>V5-T1-35</b>
Thermal Overload Relays . . . . .	<b>V5-T1-128</b>
C440/XT Electronic Overload Relay . . . . .	<b>V5-T1-141</b>
Manual Motor Protectors . . . . .	<b>V5-T1-157</b>
Combination Motor Controllers . . . . .	<b>V5-T1-193</b>
XT Electronic Manual Motor Protector . . . . .	<b>V5-T1-216</b>
Reference Data . . . . .	<b>V5-T1-229</b>

## Product Overview

The **XT** line of IEC power control offers starting and protection solutions ideal for control panels.

Innovations in the design and development allow users to reduce material costs, reduce installation effort, and enhance panel safety and performance all in a compact design. Some of these key innovations include:

- Toolless assembly of manual motor controllers and reversing contactors
- Low coil consumption
- Front accessibility to coil terminations
- Built-in surge suppression on electronic coils
- Built-in auxiliary contact for contactors up to 32A in a 45 mm frame
- Finger-safe and back-of-hand proof ratings
- Direct PLC control on 185A–2000A contactors

The **XT** line includes a large offering of power control components and accessories that cover a broad range of applications and ratings:

- Three-pole contactors to 2000A
- Four-pole contactors to 200A
- Capacitor contactors to 680 kVAR
- Mini contactors to 9A
- Relays to 16A
- Thermal overload relays to 630A
- Electronic overload relays to 1500A
- Manual motor protectors to 65A
- Manual motor controllers and combination motor controllers to 65A

## Relays and Timers



## Relays and Timers

## Product Description

Eaton's new line of **XT** relays and timers includes mini and standard frame control relays and auxiliary contacts, mini electronic on-delay and multi-function timers and an electronic star-delta (wye-delta) timer for use in star-delta (wye-delta) combinations. Because **XT** meets UL®, CSA® and CE standards, it is the perfect product solution for IEC applications all over the world. The compact, space saving and easy to install **XT** line of IEC contactors and starters is the efficient and effective solution for customer applications.

## Features

- For use with mini and standard frame size contactors and starters
- Control relays
  - AC control from 12V to 550V 50 Hz, 600V 60 Hz
  - DC control from 12V to 220V
- On-delay and multi-function timers
  - 24–240 Vac/Vdc control
- Available with screw or spring cage terminals
- Four-pole configurations
- IP20 finger and back-of-hand proof
- Large ambient temperature range: –25° to 50°C [–13° to 122°F]
- The XTRE control relays have positively driven contacts between the relay and the auxiliary contact modules as well as within the auxiliary contact modules

## Contents

## Description

	Page
Relays and Timers	
Catalog Number Selection .....	V5-T1-4
Product Selection .....	V5-T1-5
Accessories .....	V5-T1-6
Technical Data and Specifications .....	V5-T1-12
Dimensions .....	V5-T1-16
	
Miniature Controls .....	V5-T1-18
Contactors and Starters .....	V5-T1-35
Thermal Overload Relays .....	V5-T1-128
C440/ <b>XT</b> Electronic Overload Relay .....	V5-T1-141
Manual Motor Protectors .....	V5-T1-157
Combination Motor Controllers .....	V5-T1-193
<b>XT</b> Electronic Manual Motor Protector .....	V5-T1-216
Reference Data .....	V5-T1-229

## Standards and Certifications

- IEC EN 60947
- CE approved
- UL
- CSA



## Instructional Leaflets

Pub51219	XTRM Mini Control Relays
Pub51210	XTRE Control Relays
Pub51244	XTTR Electronic Star-Delta (Wye-Delta) Timer
Pub51245	XTMT Mini Electronic On-Delay and Multi-Function Timers

#### 1

### Catalog Number Selection

#### XT—Relays

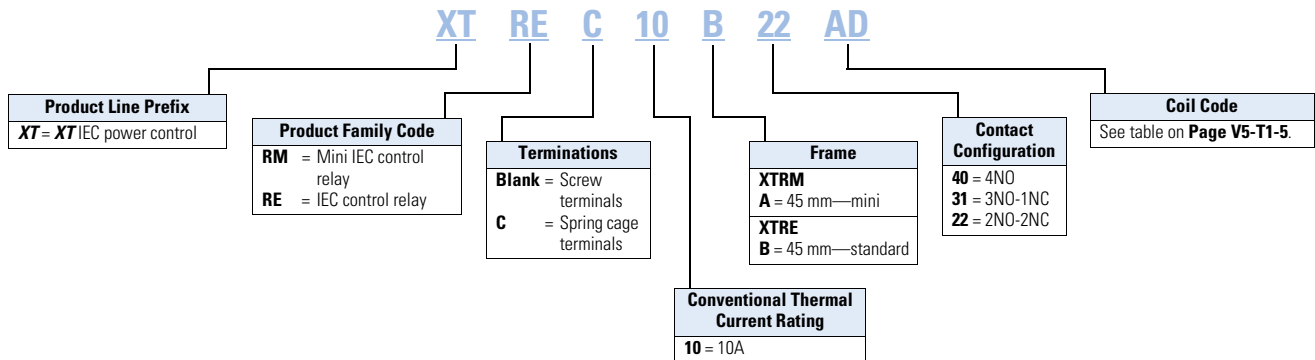

#### XT—Timers

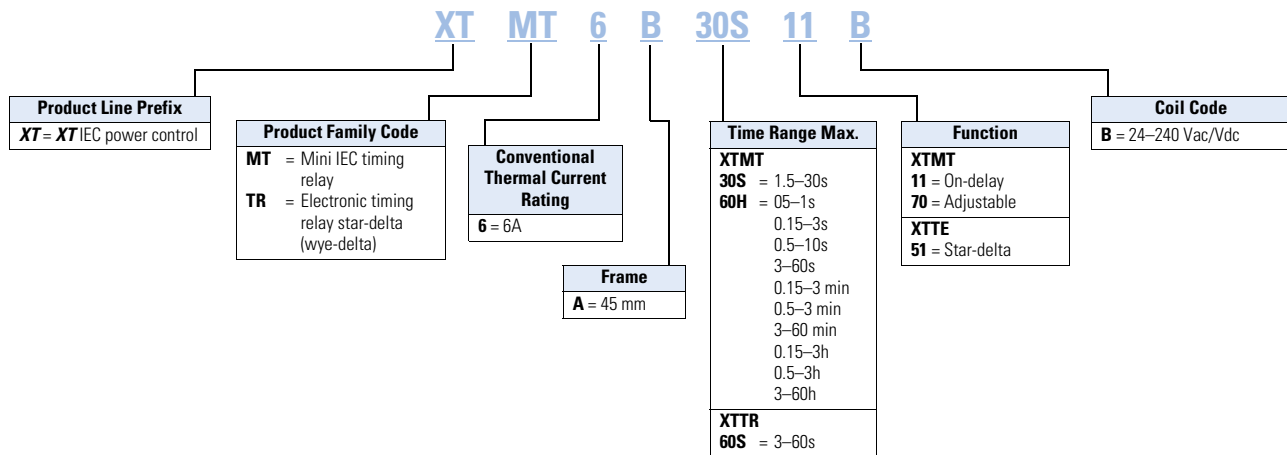

## Product Selection

### When Ordering

- Orders must be placed in multiples of the package quantity listed
- DC operated control relays have a built-in suppressor circuit
- Contact terminal numbers to EN50011
- Coil terminal numbers to EN50005

### XTRM10A\_



### Mini Control Relays

Conventional Thermal Current $I_{th}$ (A)	Contact Configuration	Rated Operational Current AC-15 $I_e$ (A)			Circuit Symbol	Screw Terminal Catalog Number <sup>①</sup>
		220–240V	380–415V	500V		
10	4NO	6	3	1.5		XTRM10A40_
10	3NO-1NC	6	3	1.5		XTRM10A31_
10	2NO-2NC	6	3	1.5		XTRM10A22_ <sup>②</sup>

### XTREC10\_



### Control Relays

Conventional Thermal Current Open at 60°C $I_{th}$ (A)	Contact Configuration	Rated Operational Current AC-15 $I_e$ (A)			Circuit Symbol	Screw Terminal Catalog Number <sup>①</sup>	Spring Cage Terminal Catalog Number <sup>①</sup>
		220–240V	380–415V	500V			
16	4NO	6	4	1.5		XTRE10B40_	XTREC10B40_
16	3NO-1NC	6	4	1.5		XTRE10B31_	XTREC10B31_
16	2NO-2NC	6	4	1.5		XTRE10B22_ <sup>③</sup>	XTREC10B22_ <sup>③</sup>

### Coil Voltage Suffix

Coil Voltage	Suffix Code	Coil Voltage	Suffix Code	Coil Voltage	Suffix Code	Coil Voltage	Suffix Code
110V 50 Hz, 120V 60 Hz	<b>A</b>	415V 50 Hz, 480V 60 Hz	<b>C</b>	380V 50 Hz, 440V 60 Hz	<b>L</b>	120 Vdc	<b>AD</b>
220V 50 Hz, 240V 60 Hz	<b>B</b>	550V 50 Hz, 600V 60 Hz	<b>D</b>	380V 60 Hz	<b>P</b>	220 Vdc	<b>BD</b>
230V 50 Hz	<b>F</b>	208V 60 Hz	<b>E</b>	12V 50/60 Hz	<b>R</b>	12 Vdc	<b>RD</b>
24V 50/60 Hz	<b>T</b>	190V 50 Hz, 220V 60 Hz	<b>G</b>	42V 50 Hz, 48V 60 Hz	<b>W</b>	48 Vdc	<b>WD</b>
24 Vdc	<b>TD</b>	240V 50 Hz, 277V 60 Hz	<b>H</b>	48V 50 Hz	<b>Y</b>		

### Notes

- <sup>①</sup> Underscore (\_) indicates magnet coil suffix required. See Coil Voltage Suffix table above.
- <sup>②</sup> DC operated control relays XTRM(C)10A22\_ cannot be used with front mount auxiliary contacts.
- <sup>③</sup> DC operated control relays XTRE(C)10B22\_ can only be combined with two-pole auxiliary contacts.

## Accessories

### Auxiliary Contacts

XTMCF\_









### Front-Mount Auxiliary Contacts for Use with XTRM Mini Control Relays

Conventional Thermal Current, I <sub>th</sub> Open (A)	Rated Operational Current AC-15 I <sub>g</sub> (A)			Contact Configuration	Contact Sequence	Pkg. Qty. ①	Screw Terminal Catalog Number
	220V	380V	500V				
10	4	2	1.5	2NC		5	XTMCXFA02
10	4	2	1.5	1NO-1NC		5	XTMCXFA11
10	4	2	1.5	2NO		5	XTMCXFA20
10	4	2	1.5	4NC		5	XTMCXFA04
10	4	2	1.5	1NO-3NC		5	XTMCXFA13
10	4	2	1.5	2NO-2NC		5	XTMCXFA22
10	4	2	1.5	3NO-1NC		5	XTMCXFA31
10	4	2	1.5	4NO		5	XTMCXFA40
10	4	2	1.5	1NO-1NC 1NO <sub>E</sub> -1NC <sub>L</sub>		5	XTMCXFA122 ②

#### Notes

- ① Orders must be placed in multiples of package quantity listed.
- ② One early-make contact (NO<sub>E</sub>), one late-break contact (NC<sub>L</sub>).

Front-Mount Auxiliary Contacts for Use with XTRE Control Relays <sup>①</sup>

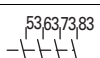
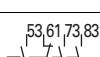
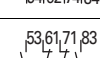
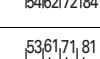
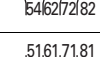
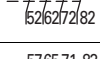
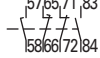
	Conventional Thermal Current, $I_{th}$ (A), Open at 60°C	Poles	Rated Operational Current AC-15 $I_e$ (A)			Contact Configuration	Circuit Symbol	Pkg. Qty. <sup>②</sup>	Screw Terminal Catalog Number
			220V 230V 240V	380V 400V 415V	500V				
<b>Two-Pole</b> 	16	2	6	3	1.5	2NO		5	XTCEXFAC20
	16	2	6	3	1.5	1NO-1NC		5	XTCEXFAC11 <sup>③</sup>
	16	2	6	3	1.5	2NC		5	XTCEXFAC02
	16	2	6	3	1.5	1NO <sub>E</sub> -1NC <sub>L</sub>		5	XTCEXFALC11 <sup>④</sup>
<b>Four-Pole</b> 	16	4	6	3	1.5	4NO		5	XTCEXFAC40 <sup>③</sup>
	16	4	6	3	1.5	3NO-1NC		5	XTCEXFAC31 <sup>③</sup>
	16	4	6	3	1.5	2NO-2NC		5	XTCEXFAC22 <sup>③</sup>
	16	4	6	3	1.5	1NO-3NC		5	XTCEXFAC13
	16	4	6	3	1.5	4NC		5	XTCEXFAC04
	16	4	6	3	1.5	1NO-1NC 1NO <sub>E</sub> -1NC <sub>L</sub>		5	XTCEXFALC22 <sup>④</sup>
	16	4	6	3	1.5				

**Notes**

- <sup>①</sup> Interlocked opposing contacts, to IEC/EN 60947-5-1 Annex L (positively driven), within the auxiliary contact modules (not NO<sub>E</sub> and NC<sub>L</sub> contacts) and between the auxiliary contacts and built-in contacts of the XTRE control relays.
- <sup>②</sup> Orders must be placed in multiples of package quantity listed.
- <sup>③</sup> Catalog number is shown with screw type terminal. For spring cage, add a "C" before the last 2 digits. For example, to order a spring cage version of the XTCEXFAC22, change the catalog number to XTCEXFACC22.
- <sup>④</sup> One early-make contact (NO<sub>E</sub>), one late-break contact (NC<sub>L</sub>).

### Suppressors

For AC operated contactors 50–60 Hz. On DC operated contactor relays and on XTRE10B, the suppressor circuit is built-in. Note dropout delay.

#### Varistor Suppressor<sup>①②</sup>

##### Varistor Suppressor for XTRE



Voltage	For Use with...	Contact Sequence	Pkg. Qty. ③	Catalog Number
24–48	XTRE(C)10B		10	<b>XTCEXVSBW</b>
48–130			10	<b>XTCEXVSA</b>
130–240			10	<b>XTCEXVSB</b>
240–500			10	<b>XTCEXVSB</b>

##### Varistor Suppressor for XTRM



XTRM Relay with Installed Suppressor



Voltage	For Use with...	Circuit Symbol	Pkg. Qty. ③	Catalog Number
24–48	XTRM6A_, XTRM9A_		10	<b>XTRM6A_</b>
48–130	XTRM6A_, XTRM9A_		10	<b>XTRM9A_</b>
110–250	XTRM6A_, XTRM9A_		10	<b>XTRM6A_</b>
380–415	XTRM6A_, XTRM9A_		10	<b>XTRM9A_</b>

#### Varistor Suppressor with Integrated LED<sup>①②</sup>

##### Varistor Suppressor for XTRE



Voltage	For Use with...	Contact Sequence	Pkg. Qty. ③	Catalog Number
24–48	XTRE(C)10B		10	<b>XTCEXVSLBW</b>
130–240			10	<b>XTCEXVSLBB</b>

#### RC Suppressor<sup>①②</sup>

##### RC Suppressor for XTRE



Voltage	For Use with...	Contact Sequence	Pkg. Qty. ③	Catalog Number
24–48	XTRE(C)10B		10	<b>XTCEXRSBW</b>
48–130			10	<b>XTCEXRSBA</b>
110–240			10	<b>XTCEXRSBB</b>
240–500			10	<b>XTCEXRSBC</b>

#### Notes



- ① Note dropout delay.
- ② For AC operated contactors, 50/60 Hz. DC operated contactors have an integrated suppressor.
- ③ Orders must be placed in multiples of package quantity listed.



**RC Suppressor** <sup>①②</sup>

XTMCXRS\_

XTRM Relay with  
Installed Suppressor**RC Suppressor for XTRM** <sup>③</sup>

Voltage	For Use with...	Circuit Symbol	Pkg. Qty. <sup>④</sup>	Catalog Number
24–48	XTRM6A_ XTRM9A_	A1 	10	<b>XTMCXRSW</b>
48–130	XTRM6A_ XTRM9A_	A2 	10	<b>XTMCXRSA</b>
110–250	XTRM6A_ XTRM9A_		10	<b>XTMCXRSB</b>

**Free-Wheel Diode Suppressor**

In addition to the built-in suppressor circuit for DC actuated contactors. Prevents negative breaking voltage when contactors are used in combination with a safety PLC.

XTCEXVSLBB

**Free-Wheel Diode Suppressor for XTRE**

Voltage	For Use with...	Pkg. Qty. <sup>④</sup>	Catalog Number
130–240	XTRE10B	10	<b>XTCEXVSLBB</b>

**Connector** <sup>⑤</sup>**Connector**

For Use with...	Pkg. Qty. <sup>④</sup>	Catalog Number
XTRE(C)10B	50	<b>XTCEXCNC</b>
XTRM10A	50	<b>XTMCXCN</b>

**Mechanical Interlock** <sup>⑥</sup>**Mechanical Interlock**

For Use with...	Pkg. Qty. <sup>④</sup>	Catalog Number
XTRE10B_	5	<b>XTCEXMLB</b>
XTRM10A_	5	<b>XTMCXML</b>

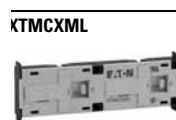
**Notes**

- ① Note dropout delay.
- ② For AC operated contactors, 50/60 Hz. DC operated contactors have an integrated suppressor.
- ③ For AC operated contactors, 50/60 Hz. Note dropout delay.
- ④ Orders must be placed in multiples of package quantity listed.
- ⑤ For mechanically arranging contactors in combinations. Distance between contactors is 0 mm.
- ⑥ For two contactors with AC or DC operated magnet system that are horizontally or vertically mounted. For Frame B, mechanical lifespan is  $2.5 \times 10^6$  operations and the distance between contactors is 0 mm.

1

#### Electronic Timer Modules

Front- (top-) mounted timer modules for use with XTRE10B control relays. Can not be combined with top-mount auxiliary contacts, XTCEXF\_.

XTCEXT\_



#### Electronic Timer Modules for XTRE

Voltage	Contact Sequence	Timing Range	For Use with...	Pkg. Qty. <sup>①</sup>	Catalog Number
<b>On-Delay</b>					
24 Vac/Vdc		0.05–1s	XTRE10B_	1	<b>XTCEXTEEC11T</b>
100–130 Vac		0.5–10s			<b>XTCEXTEEC11A</b>
200–240 Vac		15–100s			<b>XTCEXTEEC11B</b>
<b>Off-Delay</b>					
24 Vac/Vdc		0.05–1s	XTRE10B_	1	<b>XTCEXTED1C11T</b>
100–130 Vac					<b>XTCEXTED1C11A</b>
200–240 Vac					<b>XTCEXTED1C11B</b>
24 Vac/Vdc		0.5–10s	XTRE10B_	1	<b>XTCEXTED10C11T</b>
100–130 Vac					<b>XTCEXTED10C11A</b>
200–240 Vac					<b>XTCEXTED10C11B</b>
24 Vac/Vdc		5–100s	XTRE10B_	1	<b>XTCEXTED100C11T</b>
100–130 Vac					<b>XTCEXTED100C11A</b>
200–240 Vac					<b>XTCEXTED100C11B</b>
<b>Star-Delta</b>					
24 Vac/Vdc		1–30s	XTRE10B_	1	<b>XTCEXTEYC20T</b>
100–130 Vac					<b>XTCEXTEYC20A</b>
200–240 Vac					<b>XTCEXTEYC20B</b>
<b>Sealable Shroud</b>					
	Transparent sealable shroud used to protect electronic timer modules from unwanted access.		XTCEXTEE, XTCEXTED, XTCEXTEY	1	<b>XTCEXTESHRD</b>

**Note**

① Orders must be placed in multiples of package quantity listed.

## Mini Electronic Timers

## XTMT6A

## Mini Electronic On-Delay Timers



Conventional Thermal Current $I_e$ (A)	Rated Operational Current $I_o$ AC-11 Amps		Time Range	Function	Terminal Marking According to EN 50042	Catalog Number
	220/230/240V	380/400/440V				
6	3	3	1.5–30 sec	Fixed, on-delay		XTMT6A30S11B
6	3	6	0.05–1 sec 0.15–3 sec 0.5–10 sec 3–60 sec 0.15–3 min 0.5–10 min 3–60 min 0.15–3h 0.5–10h 3–60h	Fixed, on-delay		XTMT6A60H11B
6	3	3	0.05–1 sec 0.15–3 sec 0.5–10 sec 3–60 sec 0.15–3 min 0.5–10 min 3–60 min 0.15–3h 0.5–10h 3–60h	Adjustable: on-delay; fleeting contact on energization; flashing; pulse generating; ON-OFF		XTMT6A60H70B

## Electronic Star-Delta (Wye-Delta) Timers

## XTTR6A60S51

## Electronic Star-Delta (Wye-Delta) Timers



Conventional Thermal Current $I_e$ (A)	Rated Operational Current $I_o$ AC-11 Amps		Time Range	Function	Terminal Marking According to EN 50042	Catalog Number
	230V	400V				
6	3	3	3–60 sec	Fixed, star-delta		XTTR6A60S51B

**Actuating Voltage**

24–240 50/60 Hz  
24–240 Vdc

**Admissible Cable Length**

Cable unscreened, with cable cross-section 0.5–1.5 mm<sup>2</sup>  
Two-core cable  
Two-core cable in the same cable duct with the main cable, 50/60 Hz

**Connection to**

Y1/Y2, Z1/Z2  
M250  
M50

## Technical Data and Specifications

### Relays and Timers

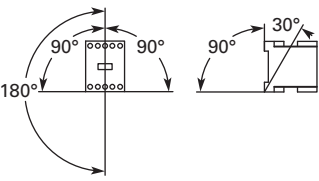
Description	XTRE	XTCEXFAC_	XTCEXTE_	XTRM	XTMCXFA_
<b>General</b>					
Standards	IEC/EN 60947, VDE 0660, UL, CSA	IEC/EN 60947, VDE 0660, UL, CSA	DIN EN 61812, IEC/EN 60947, VDE 060, UL, CSA	IEC/EN 60947, VDE 0660, UL, CSA	IEC/EN 60947, VDE 0660, UL, CSA
Lifespan, mechanical—operations					
AC operated	20,000,000	10,000,000	3,000,000	10,000,000	10,000,000
DC operated	20,000,000	10,000,000	3,000,000	20,000,000	20,000,000
Maximum operating frequency (ops/hr)	9000	9000	—	9000	9000
Climatic proofing	①	①	①	①	①
Ambient temperature					
Open (°C, min./max.)	–25/60	–25/60	–40/80	–25/50	–25/50
Enclosed (°C, min./max.)	–25/40	–25/40	–25–60	–25/40	–25/40
Ambient temperature for storage (°C, min./max.)	–40/80	–40/80	–25–40	—	—
Mounting position			As required, not suspended	As required, except vertically A1/A2 at the bottom	As required, except vertically A1/A2 at the bottom
Mechanical shock resistance (IEC/EN 60068-2-27) Half-sinusoidal shock 10 ms Base unit with auxiliary contact module					
Make contact	7g	7g	6g	10g	10g
Break contact	5g	5g	6g	8g	8g
Degree of protection	IP20	IP20	IP20	IP20	IP20
Protection against direct contact from the front when actuated by a perpendicular test finger (IEC 536)	Finger and back-of-hand proof	Finger and back-of-hand proof	Finger and back-of-hand proof	Finger and back-of-hand proof	Finger and back-of-hand proof
Weight					
AC operated (kg)	0.23	0.05	0.08	0.17	—
DC operated (kg)	0.28	0.05	0.08	0.20	—
Terminal capacity					
Screw terminals					
Solid (mm <sup>2</sup> )	1 x (0.75–4) 2 x (0.75–2.5)	1 x (0.75–4) 2 x (0.75–2.5)	1 x (0.75–2.5) 2 x (0.75–1.5)	1 x (0.75–2.5) 2 x (0.75–2.5)	1 x (0.75–2.5) 2 x (0.75–2.5)
Flexible with ferrule (mm <sup>2</sup> )	1 x (0.75–2.5) 2 x (0.75–2.5)	1 x (0.75–2.5) 2 x (0.75–2.5)	1 x (0.75–1.5) 2 x (0.75–1.5)	1 x (0.75–1.5) 2 x (0.75–1.5)	1 x (0.75–1.5) 2 x (0.75–1.5)
Solid or stranded (AWG)	18–14	—	18–14	18–14	—
Terminal screw	M3.5	M3.5	M3.5	M3.5	M3.5
Pozidriv screwdriver	Size 2	Size 2	Size 2	Size 2	Size 2
Standard screwdriver (mm)	0.8 x 5.5 1 x 6	0.8 x 5.5 1 x 6	0.8 x 5.5 1 x 6	0.8 x 5.5 1 x 6	0.8 x 5.5 1 x 6
Max. tightening torque (Nm)	1.2	1.2	1.2	1.2	1.2
Spring cage terminals					
Solid (mm <sup>2</sup> )	1 x (0.75–2.5) 2 x (0.75–2.5)	1 x (0.75–2.5) 2 x (0.75–2.5)	— —	1 x (0.75–2.5) 2 x (0.75–2.5)	1 x (0.75–2.5) 2 x (0.75–2.5)
Flexible with or without ferrule DIN 46228 (mm <sup>2</sup> )	1 x (0.75–2.5) 2 x (0.75–2.5)	1 x (0.75–2.5) 2 x (0.75–2.5)	— —	1 x (0.75–2.5) 2 x (0.75–2.5)	1 x (0.75–2.5) 2 x (0.75–2.5)
Solid or stranded (AWG)	18–14	18–14	—	18–14	18–14
Standard screwdriver (mm)	0.6 x 3.5	0.6 x 3.5	—	0.6 x 3.5	0.6 x 3.5

#### Note

① Damp heat, constant, to IEC 60068-2-78; damp heat, cyclical, to IEC 60068-2-30.

## Relays and Timers, continued

Description	XTRE	XTCEXFAC_	XTCEXTE_	XTRM	XTMCXFA_
<b>Contacts</b>					
Interlocked opposing contacts to ZH 1/457, including auxiliary contact module	Yes	Yes	No	Yes	Yes
Rated impulse withstand voltage ( $U_{imp}$ ) Vac	6000	6000	6000	6000	6000
Overtoltage category/pollution degree	III/3	III/3	III/3	III/3	III/3
Rated insulation voltage ( $U_i$ ) Vac	690	690	600	690	690
Rated operational voltage ( $U_o$ ) Vac	690	500	400	600	600
Safe isolation to VDE 0106 Part 101 and Part 101/A1					
Between coil and auxiliary contacts (Vac)	400	400	250	300	300
Between the auxiliary contacts (Vac)	400	400	250	300	300
Rated operational current					
AC-15 220/240V $I_b$	6	6	Please inquire	6	4
380/415V $I_b$	4	3	Please inquire	3	2
500V $I_b$	1.5	—	—	1.5	1.5
DC-13 <sup>Ⓞ</sup>					
DC13 L/R ≤15 ms					
Contacts in series—voltage:					
1—24V	10	10	—	2.5	2.5
1—60V	6	6	—	—	—
2—60V	10	10	—	2.5	2.5
1—110V	3	3	—	—	—
3—110V	6	6	—	1.5	1.5
1—220V	1	1	—	—	—
3—220V	5	5	—	0.5	0.5
DC13 L/R ≤50 ms					
Contacts in series—voltage:					
3—24V	4	—	—	—	—
3—60V	4	—	—	—	—
3—110V	2	—	—	—	—
3—220V	1	—	—	—	—
Control circuit reliability (at $U_o = 24$ Vdc, $U_{min} = 17$ , $I_{min} = 5.4$ mA)	Failure rate = $<10^{-8}$ , $<1$ failure in 100 million operations			Failure rate = $<10^{-8}$ , $<1$ failure in 100 million operations	
Conventional thermal current ( $I_{th}$ )	16	16	6	10	10
Short-circuit rating without welding					
Maximum overcurrent protective device					
220/240V—XTPR Frame B	4	—	—	4	4
380/415V—XTPR Frame B	4	—	—	4	4
Short-circuit protection, max. fuse					
500V (A gG/gL)	10	10	6	6	6
500V (A fast)	—	—	—	10	10
Current heat losses at load of $I_{th}$					
AC operated (W)	0.3	0.3	—	0.2	0.2
DC operated (W)	0.3	0.3	—	0.3	0.3

**Note**

<sup>Ⓞ</sup> Making and breaking conditions to DC13, time constant as stated.

## Relays and Timers, continued

Description	XTRE	XTCEXFAC_	XTCEXTE_	XTRM	XTMCXFA_
<b>Magnet Systems</b>					
Pickup and dropout values					
AC operated					
Single-voltage coil 50 Hz and dual-voltage coil 50 Hz, 60 Hz (pickup x U <sub>c</sub> )	0.8–1.1	—	0.85–1.1	0.8–1.1	—
Dual-frequency coil 50/60 Hz (pickup x U <sub>c</sub> )	0.8–1.1	—	—	0.85–1.1	—
DC operated <sup>①</sup>					
Pickup voltage (pickup x U <sub>c</sub> )	0.8–1.1	—	0.7–1.2	0.85–1.3	—
At 24V: without auxiliary contact module (40°C) (pickup x U <sub>c</sub> )	0.7–1.3	—	—	0.7–1.3	—
Power consumption					
Single-voltage coil 50 Hz and dual-voltage coil 50 Hz, 60 Hz					
Pickup VA	24	—	—	25	—
Pickup W	19	—	—	22	—
Sealing VA	3.4	—	2	4.6	—
Sealing W	1.2	—	1.8	1.3	—
Dual-frequency coil 50/60 Hz at 50 Hz					
Pickup VA	27	—	—	30	—
Pickup W	22	—	—	26	—
Sealing VA	4.2	—	—	5.4	—
Sealing W	1.4	—	—	1.6	—
Dual-frequency coil 50/60 Hz at 60 Hz					
Pickup VA	25	—	—	29	—
Pickup W	21	—	—	24	—
Sealing VA	3.3	—	—	3.9	—
Sealing W	1.2	—	—	1.2	—
DC operated					
Pull-in = sealing (W)	3	—	—	2.6	—
Duty factor (% DF)	100	—	100	100	—
Switching times at 100% U <sub>c</sub> (approximate values)					
AC operated closing delay (ms)	≤21	—	—	14–21	—
AC operated NO contact opening delay (ms)	≤18	—	—	8–18	—
AC operated with auxiliary contact module, max. closing delay (ms)	—	—	—	45	45
DC operated closing delay (ms)	≤31	—	—	26–35	—
DC operated NO contact opening delay (ms)	≤12	—	—	15–25	—
DC operated with auxiliary contact module, max. closing delay (ms)	—	—	—	70	70

**Note**

<sup>①</sup> Smoothed DC or three-phase bridge rectifier.

**Control Relays—Characteristic Curves**

**XTRE (AC-15)**

Component lifespan (operations)  
 $I_e$  = Rated operational current

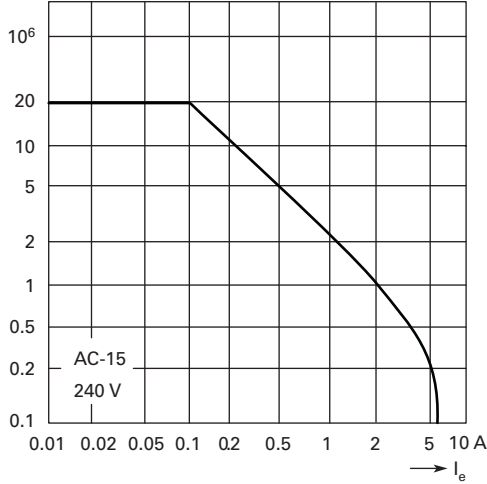

**XTRE (DC-13) ①**

Component lifespan (operations)  
 $I_e$  = Rated operational current

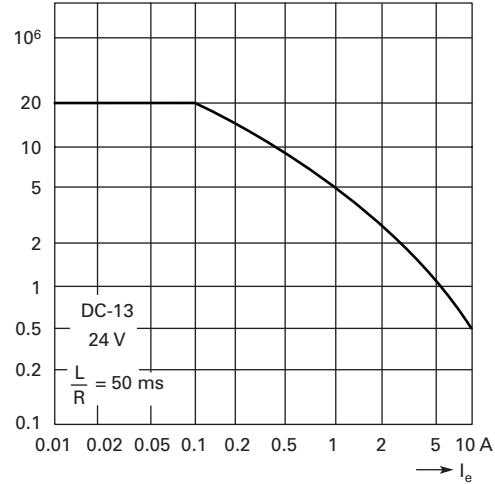

The diagrams show the closing and opening travel of the contact of the contactor relays and auxiliary contacts at no load. Tolerances are not taken into consideration.

**Contact Travel Diagrams**

**XTRE**

XTRE\_ — AC Operation

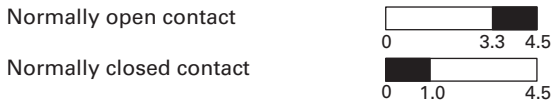

XTCEXFAC\_ — AC Operation

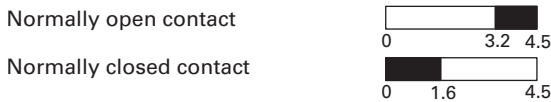

XTCEXFALC\_ — AC Operation

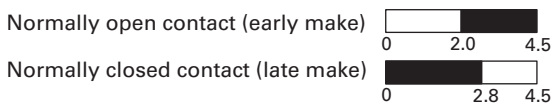

XTRE — DC Operation

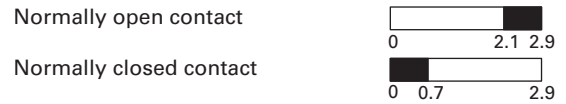

XTCEXFAC\_ — DC Operation

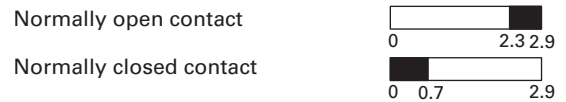

XTCEXFALC\_ — DC Operation

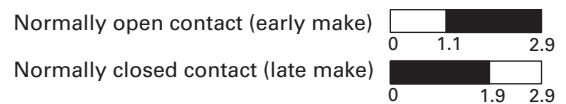

**Note**

① Making and breaking conditions to DC-13, time constant as stated.

#### Flow Diagrams—Electronic Timers, XTMT Mini Timers

##### On-Delay

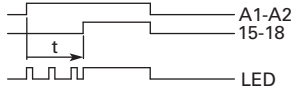

##### ON-OFF Function

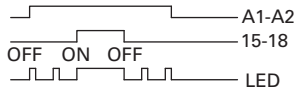

##### Fleeting Contact on Energization

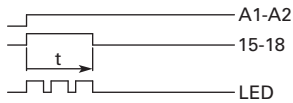

##### Flashing, Pulse Initiating

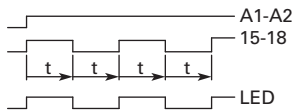

##### Pulse Generating

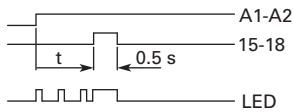

#### Star-Delta (Wye-Delta) Timer

##### Star-Delta

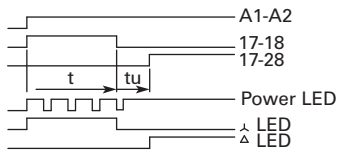

#### Rating Data

##### Rating Data for Approved Types

Pilot Duty	General Use
<b>Control Relays—XTMR</b>	
A600, P300	10A–600 Vac 0.5A–250 Vdc
<b>Timers—XTMT, XTTR</b>	
B300	6A–250 Vac

#### Dimensions

Approximate Dimensions in mm [in.]

##### Mini Contactor Relays

##### Mini Control Relay XTRM

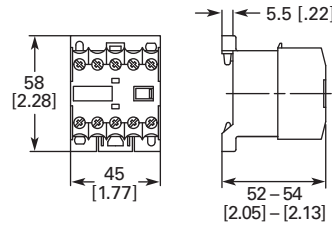

##### XTRM Mini Control Relay with IP40 XTMCX Shroud

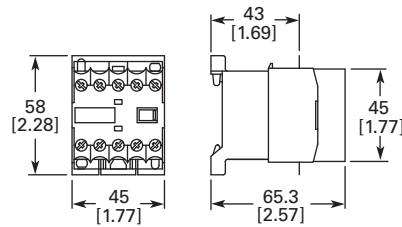

##### XTRM Mini Control Relay with RC or Varistor Suppressor

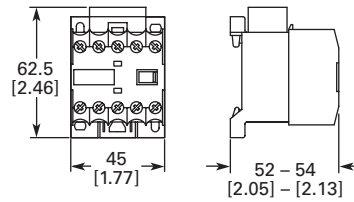

##### XTRM Mini Control Relay with XTMCXFA Auxiliary Contact

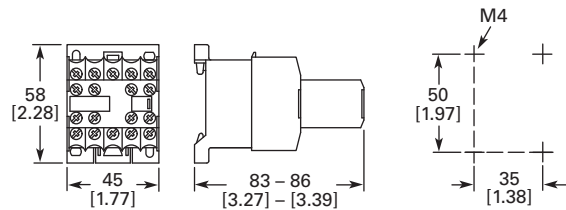



Approximate Dimensions in mm [in.]

**Control Relays**

**Control Relay XTRE with XTCEXFA Auxiliary Contact**

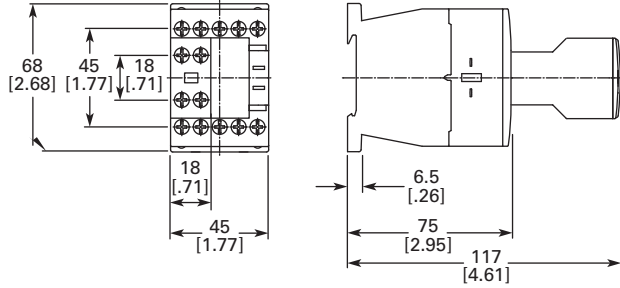

**Control Relay XTRE with XTCEXMLB Mechanical Interlock**

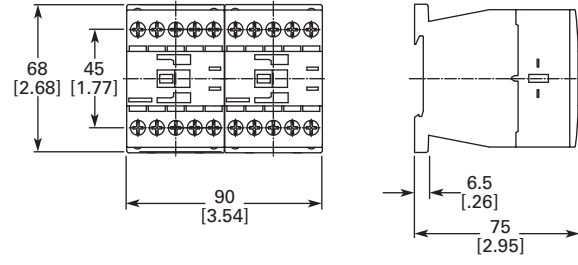

**Control Relay with Spring Cage Terminals XTREC with XTCEXFA Auxiliary Contact**

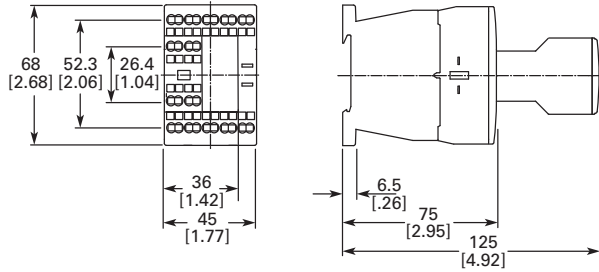

**Coil Suppressors for Use with XTRE Control Relays**

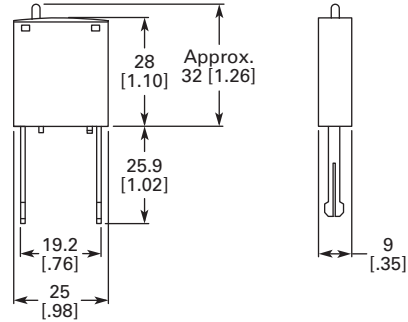

**Electronic Timer Module XTCEXTE**

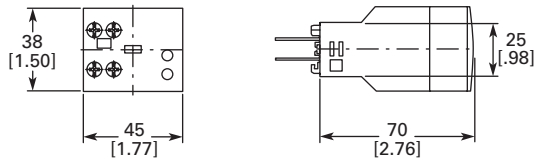

#### XTMC Miniature Contactor



### Miniature Controls

#### Product Description

Eaton's new line of **XT** miniature controls includes non-reversing and reversing mini contactors, mini overload relays and snap-on accessories. A wide range of applications is possible, including small electrical motors from fractional to 5 hp (460 Vac) or up to 4 kW (400 Vac).

#### Application Description

Due to its compact size, the **XT** line of mini controls is best suited to be applied in light-duty loads, such as hoisting, packaging, material handling, heating, lighting and automation systems. **XT** mini contactors are a particularly compact, economic and environmentally friendly solution wherever control of small motors or loads is required.

#### Features

##### Mini Contactors—Types XTMC and XTMF, 6–9A

- AC control from 12V to 550V 50 Hz, 600V 60 Hz
- DC control from 12V to 220V
- Reversing or non-reversing
- Three- and four-pole configurations
  - Three-pole XTMC
  - Four-pole XTMF
- Panel or DIN rail mounting
- IP20 finger and back-of-hand proof
- Low noise operation
- High degree of climatic proofing
- Large ambient temperature range –25° to 50°C [–13° to 122°F]

### Contents

#### Description

	<i>Page</i>
Relays and Timers .....	<b>V5-T1-3</b>
Miniature Controls	
Catalog Number Selection .....	<b>V5-T1-19</b>
Product Selection .....	<b>V5-T1-20</b>
Accessories .....	<b>V5-T1-24</b>
Technical Data and Specifications .....	<b>V5-T1-27</b>
Wiring Diagrams .....	<b>V5-T1-32</b>
Dimensions .....	<b>V5-T1-34</b>
	
Contactors and Starters .....	<b>V5-T1-35</b>
Thermal Overload Relays .....	<b>V5-T1-128</b>
C440/ <b>XT</b> Electronic Overload Relay .....	<b>V5-T1-141</b>
Manual Motor Protectors .....	<b>V5-T1-157</b>
Combination Motor Controllers .....	<b>V5-T1-193</b>
<b>XT</b> Electronic Manual Motor Protector .....	<b>V5-T1-216</b>
Reference Data .....	<b>V5-T1-229</b>

#### Standards and Certifications

- IEC EN 60947
- CE approved
- UL
- CSA
- CCC
- ATEX



**Instructional Leaflets**

- Pub51219 XTMC, XTMF Mini Contactors, XTRM Mini Control Relay and Accessories
- Pub51243 XTOM Mini Overload Relays
- Pub51206 Mini Reversing Link Kits
- MN03402002E XTOM Mini Overload Relays Installation and User Manual

**Catalog Number Selection**

**XT IEC Miniature Contactors**

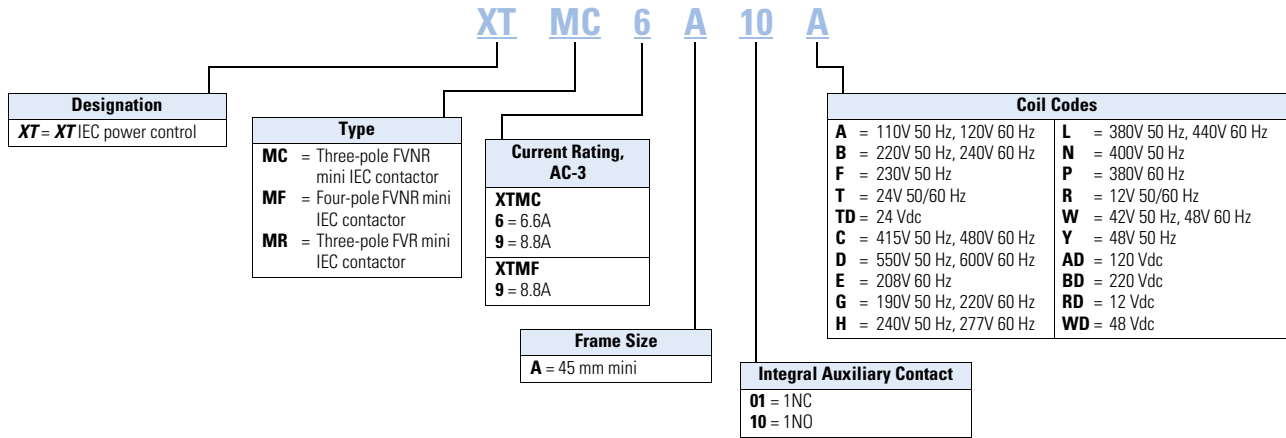

**XT IEC Miniature Overload Relays**

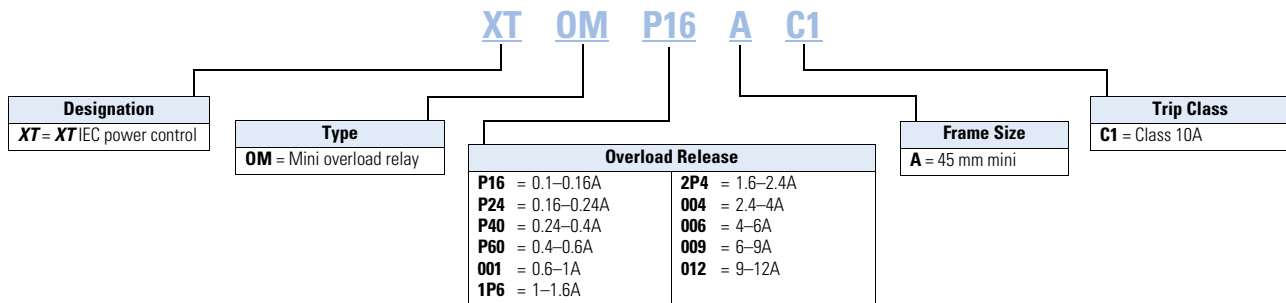

### Product Selection

#### Full Voltage Non-Reversing Miniature Contactors

XTMC\_



#### Maximum UL Ratings—Single-Phase and Three-Phase

##### Horsepower Ratings

Single-Phase			Three-Phase				Number of Power Poles	Auxiliary Contacts	Screw Terminal Catalog Number <sup>①</sup>
115V	200V	230V	200V	230V	460V	575V			
1/4	3/4	1	1-1/2	2	3	3	3	1NO	XTMC6A10_
1/4	3/4	1	1-1/2	2	3	3	3	1NC	XTMC6A01_
1/2	1	1-1/2	2	3	5	5	3	1NO	XTMC9A10_
1/2	1	1-1/2	2	3	5	5	3	1NC	XTMC9A01_
1/2	1	1-1/2	2	3	5	5	4	—	XTMF9A00_

#### Maximum IEC Ratings AC-3

Operational Current AC-3 Amp Rating 380/400V	Conventional Free Air Thermal Current AC-1 at 50°C	Three-Phase Motors 50–60 Hz				Number of Power Poles	Auxiliary Contacts	Screw Terminal Catalog Number <sup>①</sup>
		220–240V	380–400V	550V	660/690V			
6.6	20	1.5	3	3	3	3	1NO	XTMC6A10_
6.6	20	1.5	3	3	3	3	1NC	XTMC6A01_
8.8	20	2.2	4	4	4	3	1NO	XTMC9A10_
8.8	20	2.2	4	4	4	3	1NC	XTMC9A01_
8.8	20	2.2	4	4	4	4	—	XTMF9A00_

#### Magnet Coil Suffix

Coil Voltage	Suffix Code	Coil Voltage	Suffix Code	Coil Voltage	Suffix Code	Coil Voltage	Suffix Code
110V 50 Hz, 120V 60 Hz	<b>A</b>	415V 50 Hz, 480V 60 Hz	<b>C</b>	380V 60 Hz	<b>P</b>	120 Vdc	<b>AD</b>
220V 50 Hz, 240V 60 Hz	<b>B</b>	550V 50 Hz, 600V 60 Hz	<b>D</b> <sup>③</sup>	12V 50/60 Hz	<b>R</b> <sup>③</sup>	220 Vdc	<b>BD</b>
230V 50 Hz	<b>F</b>	208V 60 Hz	<b>E</b>	42V 50 Hz, 48V 60 Hz	<b>W</b>	12 Vdc	<b>RD</b>
24V 50/60 Hz	<b>T</b>	190V 50 Hz, 220V 60 Hz	<b>G</b>	48V 50 Hz	<b>Y</b>	48 Vdc	<b>WD</b>
24 Vdc	<b>TD</b> <sup>②</sup>	240V 50 Hz, 277V 60 Hz	<b>H</b>	—	—	—	—
—	—	380V 50 Hz, 440V 60 Hz	<b>L</b>	—	—	—	—

#### Notes

IEC Utilization Categories, see **Page V5-T1-242**.

AC-1: Non-inductive or slightly inductive loads.

AC-3: Squirrel cage motors—starting, switching of motors during running.

AC-4: Squirrel cage motors—starting, plugging, inching.

① Underscore ( \_ ) indicates magnetic coil suffix required.

② With DC operation: Integrated diode resistor combination, coil rating 2.6W.

③ XTMF four-pole contactor not available with “D” or “R” coil voltage suffix.

## Full Voltage Reversing Miniature Contactors

XTMR\_



## Maximum UL Ratings—Single-Phase and Three-Phase

## Horsepower Ratings

Single-Phase			Three-Phase				Spare Auxiliary Contacts		Catalog Number <sup>①②</sup>
115V	200V	230V	200V	230V	460V	575V	K1M	K2M	
1/4	3/4	1	1-1/2	2	3	3	-  63 64	-  63 64	XTMR6A21_
1/2	1	1-1/2	2	3	5	5	-  63 64	-  63 64	XTMR9A21_

## Maximum IEC Ratings AC-3

## Three-Phase Motors 50–60 Hz

Operational Current AC-3 Amp Rating 380/400V	Conventional Free Air Thermal Current AC-1 at 50°C	Three-Phase Motors 50–60 Hz				Spare Auxiliary Contacts		Catalog Number <sup>①②</sup>
		220/ 230/ 240V	380/ 400/ 440V	500V	660/ 690V	K1M	K2M	
6.6	20	1.5	3	3	3	-  63 64	-  63 64	XTMR6A21_
8.8	20	2.2	4	4	4	-  63 64	-  63 64	XTMR9A21_

## Magnet Coil Suffix

Coil Voltage	Suffix Code	Coil Voltage	Suffix Code	Coil Voltage	Suffix Code	Coil Voltage	Suffix Code
110V 50 Hz, 120V 60 Hz	<b>A</b>	415V 50 Hz, 480V 60 Hz	<b>C</b>	380V 60 Hz	<b>P</b>	120 Vdc	<b>AD</b>
220V 50 Hz, 240V 60 Hz	<b>B</b>	550V 50 Hz, 600V 60 Hz	<b>D</b> <sup>③</sup>	12V 50/60 Hz	<b>R</b> <sup>③</sup>	220 Vdc	<b>BD</b>
230V 50 Hz	<b>F</b>	208V 60 Hz	<b>E</b>	42V 50 Hz, 48V 60 Hz	<b>W</b>	12 Vdc	<b>RD</b>
24V 50/60 Hz	<b>T</b>	190V 50 Hz, 220V 60 Hz	<b>G</b>	48V 50 Hz	<b>Y</b>	48 Vdc	<b>WD</b>
24 Vdc	<b>TD</b> <sup>②</sup>	240V 50 Hz, 277V 60 Hz	<b>H</b>	—	—	—	—
—	—	380V 50 Hz, 440V 60 Hz	<b>L</b>	—	—	—	—

## Notes

IEC Utilization Categories, see **Page V5-T1-242**.

AC-1: Non-inductive or slightly inductive loads.

AC-3: Squirrel cage motors—starting, switching of motors during running.

AC-4: Squirrel cage motors—starting, plugging, inching.

① Underscore ( \_ ) indicates magnetic coil suffix required. See Magnet Coil Suffix table above.

② The factory-installed reversing mini contactor includes (2) XTMC...01 contactors, (2) XTMCXFA20 2NO front-mount auxiliary contacts (1) XTMCXRL reversing link kit and (1) XTMCXML mechanical interlock.

③ XTMF four-pole contactor not available with "D" or "R" coil voltage suffix.

### Star-Delta (Wye-Delta) Miniature Contactors

XTMC\_



#### Maximum Current UL Ratings—Single-Phase and Three-Phase ①

Horsepower Ratings							Maximum Changeover Time (sec.)	Spare Auxiliary Contacts K1M	Component Description	Catalog Number ②
Single-Phase			Three-Phase							
115V	200V	230V	200V	230V	460V	575V				
1/2	1	1-1/2	2	3	5	7-1/2	30	$\begin{matrix}  21 31 53 \\ -7-7-1 \\  22 32 54 \end{matrix}$	K1M main contactor	XTMC9A10_
									K1M auxiliary contact	XTMCXFC22
									K5M delta contactor	XTMC9A01_
									K3M star contactor	XTMC9A10_
									K3M auxiliary contact	XTMCXFC02
									K1T timing relay	XTTR6A60S51B

#### Maximum IEC Ratings AC-3 ①

Horsepower Ratings			Maximum Changeover Time (sec.)	Spare Auxiliary Contacts K1M	Component Description	Catalog Number ②
Three-Phase Motors 50–60 Hz						
220/230/240V	380/400/440V	500V				
4	5.5	5.5	30	$\begin{matrix}  21 31 53 \\ -7-7-1 \\  22 32 54 \end{matrix}$	K1M main contactor	XTMC9A10_
					K1M auxiliary contact	XTMCXFC22
					K5M delta contactor	XTMC9A01_
					K3M star contactor	XTMC9A10_
					K3M auxiliary contact	XTMCXFC02
					K1T timing relay	XTTR6A60S51B

#### Mini Overload Relay Settings (A)

Setting	Starting
<b>A:</b> $I_N \times 0.58$ Motor protection in the Y and delta configurations.	$\leq 15$ sec
<b>B:</b> $I_N \times 1$ Only partial motor protection in star position	15–40 sec
<b>C:</b> $I_N \times 0.58$ Motor not protected in star position.	$> 40$ sec
Timing relay set to approximately 10 sec.	

#### Notes

Depending on the coordination type required (that is, Type 1 or Type 2) it must be established whether the fuse protection and the input wiring for the main and delta contactors are to be common or separate.

① Operating frequency: 30 starts/hour. See Magnet Coil Suffix table on following page.

② Underscore ( \_ ) indicates magnet coil suffix required.

## Magnet Coil Suffix

Coil Voltage	Suffix Code	Coil Voltage	Suffix Code	Coil Voltage	Suffix Code	Coil Voltage	Suffix Code
110V 50 Hz, 120V 60 Hz	<b>A</b>	415V 50 Hz, 480V 60 Hz	<b>C</b>	400V 50 Hz	<b>N</b>	120 Vdc	<b>AD</b>
220V 50 Hz, 240V 60 Hz	<b>B</b>	550V 50 Hz, 600V 60 Hz	<b>D</b>	380V 60 Hz	<b>P</b>	220 Vdc	<b>BD</b>
230V 50 Hz	<b>F</b>	208V 60 Hz	<b>E</b>	12V 50/60 Hz	<b>R</b>	12 Vdc	<b>RD</b>
24V 50/60 Hz	<b>T</b>	190V 50 Hz, 220V 60 Hz	<b>G</b>	24V 50 Hz	<b>U</b>	48 Vdc	<b>WD</b>
24 Vdc	<b>TD</b> <sup>①</sup>	240V 50 Hz, 277V 60 Hz	<b>H</b>	42V 50 Hz, 48V 60 Hz	<b>W</b>	—	—
—	—	380V 50 Hz, 440V 60 Hz	<b>L</b>	48V 50 Hz	<b>Y</b>	—	—

## Mini Overload Relays

XTOM\_ Mini Overload Relays <sup>②③</sup>

Overload Release I <sub>n</sub>	Trip Class	Contact Sequence	Contact Configuration	Short-Circuit Protection (A)		Circuit Breaker	CEC/NEC Fuse	Catalog Number
				Type 1 Coordination, gG/gL	Type 2 Coordination, gG/gL			
0.1–0.16A	10A	97 95	1NO-1NC	20	0.5	15	—	<b>XTOMP16AC1</b>
0.16–0.24A	10A		1NO-1NC	20	1	15	—	<b>XTOMP24AC1</b>
0.24–0.4A	10A		1NO-1NC	20	2	15	—	<b>XTOMP40AC1</b>
0.4–0.6A	10A	—	1NO-1NC	20	2	15	—	<b>XTOMP60AC1</b>
0.6–1A	10A	—	1NO-1NC	20	4	15	3	<b>XTOM001AC1</b>
1–1.6A	10A	—	1NO-1NC	20	6	15	6	<b>XTOM1P6AC1</b>
1.6–2.4A	10A	—	1NO-1NC	20	6	15	6	<b>XTOM2P4AC1</b>
2.4–4A	10A	—	1NO-1NC	20	—	15	15	<b>XTOM004AC1</b>
4–6A	10A	—	1NO-1NC	20	—	15	20	<b>XTOM006AC1</b>
6–9A	10A	—	1NO-1NC	20	—	15	35	<b>XTOM009AC1</b>
9–12A	10A	—	1NO-1NC	—	—	—	45	<b>XTOM012AC1</b>

## Notes

- ① With DC operation: Integrated diode resistor combination, coil rating 2.6W.
- ② Short-circuit protection: Observe the maximum permissible fuse of the contactor with direct device mounting. See MN03402002E for more information.
- ③ When fitted directly to the contactor, a clearance of at least 5 mm is required between the overload relays.

## Accessories

### Auxiliary Contacts

Front-mounted snap-on auxiliary contacts for mini contactors are available with screw terminals in a variety of contact configurations. Auxiliary contact modules are standard with interlocked opposing contacts, except in the case of early-make or late-break contacts.

#### Front-Mount Auxiliary Contacts for Use with Mini Contactors

Conventional Free Air Thermal Current, $I_{th} = I_e$ , AC-1 in Amps	Contact Configuration	Contact Sequence	Pkg. Qty. ①	Screw Terminal Catalog Number
10	2NC		5	<b>XTMCXFC02</b>
10	1NO-1NC		5	<b>XTMCXFD11</b>
10	2NO-2NC		5	<b>XTMCXFC22</b>
10	2NC		5	<b>XTMCXFA02</b>
10	1NO-1NC		5	<b>XTMCXFA11</b>
10	2NO		5	<b>XTMCXFA20</b>
10	4NC		5	<b>XTMCXFA04</b>
10	1NO-3NC		5	<b>XTMCXFA13</b>
10	2NO-2NC		5	<b>XTMCXFA22</b>
10	3NO-1NC		5	<b>XTMCXFA31</b>
10	4NO		5	<b>XTMCXFA40</b>
10	1NO-1NC 1NO <sub>E</sub> -1NC <sub>L</sub>		5	<b>XTMCXFAL22</b> ②

#### Notes

① Orders must be placed in multiples of package quantity listed.

② One early-make contact (NO<sub>E</sub>), one late-break contact (NC<sub>L</sub>).



**Suppressors**

XTMCXR\_

**RC Suppressor** ①

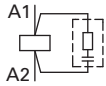
Voltage	For Use with...	Circuit Symbol	Pkg. Qty. ②	Catalog Number
24–48	XTMC6A_ XTMC9A_		10	<b>XTMCXRSW</b>
48–130	XTMC6A_ XTMC9A_		10	<b>XTMCXRSA</b>
110–250	XTMC6A_ XTMC9A_		10	<b>XTMCXRSB</b>

XTMC Relay with  
Installed Suppressor

XTMCX\_

**Varistor Suppressor** ③

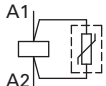
Voltage	For Use with...	Circuit Symbol	Pkg. Qty. ②	Catalog Number
24–48	XTMC6A_ XTMC9A_		10	<b>XTMCXVSW</b>
48–130	XTMC6A_ XTMC9A_		10	<b>XTMCXVSA</b>
110–250	XTMC6A_ XTMC9A_		10	<b>XTMCXVSB</b>
380–415	XTMC6A_ XTMC9A_		10	<b>XTMCXVSN</b>

XTMC Relay with  
Installed Suppressor**Mechanical Interlock**

XTMCXML

**Mechanical Interlock**

Description	Pkg. Qty. ②	Catalog Number
Mechanical interlock	5	<b>XTMCXML</b>

**Notes**

For two contactors with AC or DC operated magnet system that are horizontally or vertically mounted, the distance between contactors is 0 mm and the mechanical lifespan is  $2.5 \times 10^6$  operations.

① For AC operated contactors, 50/60 Hz. Note dropout delay.

② Orders must be placed in multiples of package quantity listed.

③ For AC operated contactors, 50/60 Hz. DC operated contactors have integrated varistor suppressors.

**Additional Accessories****XTMCXRL****Reversing Link Kit** <sup>①②</sup>

Description	Pkg. Qty. <sup>③</sup>	Catalog Number
Main current wiring for reversing contactors and starters	1	<b>XTMCXRL</b>

**XTMCXSDL****Star-Delta (Wye-Delta) Link Kit** <sup>④⑤</sup>

Description	Pkg. Qty. <sup>③</sup>	Catalog Number
Main current wiring for star-delta (wye-delta) combinations. Includes the star-delta bridge	1	<b>XTMCXSDL</b>

**XTMCXCN****Connector**

Description	Pkg. Qty. <sup>③</sup>	Catalog Number
For mechanically arranging contactors and timing relays in combinations	50	<b>XTMCXCN</b> <sup>⑥</sup>

**XTMCXSHROUD****IP40 Sealable Transparent Shroud**

Description	Pkg. Qty. <sup>③</sup>	Catalog Number
IP40 sealable transparent shroud, snap fitting on mini contactor	1	<b>XTMCXSHROUD</b>

**Notes**

- ① The following control cables are integrated as part of the electrical interlock: K1M: A1–K2M: 21; K1M: 21–K2M: A1
- ② Reversing link kit does not include mechanical interlock. See Mechanical Interlock.
- ③ Orders must be placed in multiples of package quantity listed.
- ④ The following control cables are integrated in addition to the electrical interlock: K3M: A1–K5M: 21; K3M: 21–K5M: A1; K3M: A2–K5M: A2
- ⑤ When combined with overload relay, use separate mounting.
- ⑥ 0 mm distance between contactors.

## Technical Data and Specifications

### XT Miniature Controls—General

Description	XTMC6A_		XTMC9A_		XTMF9A_	
	AC Coils	DC Coils	AC Coils	DC Coils	AC Coils	DC Coils
<b>Physical and Electrical</b>						
Standards	IEC/EN 60947, VDE 0660, CSA, UL, CCC	IEC/EN 60947, VDE 0660, CSA, UL, CCC	IEC/EN 60947, VDE 0660, CSA, UL, CCC	IEC/EN 60947, VDE 0660, CSA, UL, CCC	IEC/EN 60947, VDE 0660, CSA, UL, CCC	IEC/EN 60947, VDE 0660, CSA, UL, CCC
Weights in kg [lb]	0.2 [0.44]	0.17 [0.37]	0.2 [0.44]	0.17 [0.34]	0.2 [0.44]	0.17 [0.37]
Mechanical life—operations	10,000,000	20,000,000	10,000,000	20,000,000	10,000,000	10,000,000
Mechanical life—coil at 50 Hz	7	—	7	—	7	—
Maximum mechanical operating frequency (ops/hr)	9000	9000	9000	9000	9000	9000
Insulation voltage (U <sub>i</sub> ) Vac	690	690	690	690	690	690
Impulse withstand voltage (U <sub>imp</sub> ) Vac	6000	6000	6000	6000	6000	6000
Operational Voltage (U <sub>o</sub> ) Vac	690	690	690	690	690	690
Safe isolation to VDE 0106 Part 101 and Part 101/A1						
Between coil and contacts (Vac)	300	300	300	300	300	300
Between contacts (Vac)	300	300	300	300	300	300
Making capacity (amps)	110	110	110	110	110	110
Breaking capacity (amps)						
220/230V	90	90	90	90	90	90
380/400V	90	90	90	90	90	90
500V	64	64	64	64	64	64
660/690V	54	54	54	54	54	54
Short-circuit protection rating maximum fuse (gL/gG)						
Type 2 coordination (A)	10	10	10	10	10	10
Type 1 coordination (A)	20	20	20	20	20	20
Degree of protection	IP20	IP20	IP20	IP20	IP20	IP20
Flexible with ferrule (mm <sup>2</sup> )	1 x (0.75–1.5) 2 x (0.75–1.5)	1 x (0.75–1.5) 2 x (0.75–1.5)	1 x (0.75–1.5) 2 x (0.75–1.5)	1 x (0.75–1.5) 2 x (0.75–1.5)	1 x (0.75–1.5) 2 x (0.75–1.5)	1 x (0.75–1.5) 2 x (0.75–1.5)
Solid or stranded (AWG)	18–14	18–14	18–14	18–14	18–14	18–14
Terminal screw	M3.5	M3.5	M3.5	M3.5	M3.5	M3.5
Pozidriv screwdriver	Size 2	Size 2	Size 2	Size 2	Size 2	Size 2
Standard screwdriver (mm)	0.8 x 5.5 1 x 6	0.8 x 5.5 1 x 6	0.8 x 5.5 1 x 6	0.8 x 5.5 1 x 6	0.8 x 5.5 1 x 6	0.8 x 5.5 1 x 6
Max. tightening torque						
Nm	1.2	1.2	1.2	1.2	1.2	1.2
Lb-in	10.6	10.6	10.6	10.6	10.6	10.6
Terminal capacity of spring cage main terminals						
Solid (mm <sup>2</sup> )	1 x (1–2.5) 2 x (1–2.5)	1 x (1–2.5) 2 x (1–2.5)	1 x (1–2.5) 2 x (1–2.5)	1 x (1–2.5) 2 x (1–2.5)	1 x (1–2.5) 2 x (1–2.5)	1 x (1–2.5) 2 x (1–2.5)
Flexible with ferrule (mm <sup>2</sup> )	1 x (1–2.5) 2 x (1–2.5)	1 x (1–2.5) 2 x (1–2.5)	1 x (1–2.5) 2 x (1–2.5)	1 x (1–2.5) 2 x (1–2.5)	1 x (1–2.5) 2 x (1–2.5)	1 x (1–2.5) 2 x (1–2.5)
Standard screwdriver (mm)	0.6 x 3.5	0.6 x 3.5	0.6 x 3.5	0.6 x 3.5	0.6 x 3.5	0.6 x 3.5
Mounting position	①	①	①	①	①	①

#### Note

① As required, except vertical with terminals A1/A2 at the bottom.



## XT Miniature Controls—General, continued

Description	XTMC6A_	DC Coils	XTMC9A_	DC Coils	XTMF9A_	DC Coils
	AC Coils		AC Coils		AC Coils	
<b>Environmental</b>						
Ambient temperature	–25° to 50°C [–13° to 122°F]	–25° to 50°C [–13° to 122°F]	–25° to 50°C [–13° to 122°F]	–25° to 50°C [–13° to 122°F]	–25° to 50°C [–13° to 122°F]	–25° to 50°C [–13° to 122°F]
Mechanical shock resistance (IEC/EN 60068-2-27)						
Half-sinusoidal shock 10 ms						
Contactor without auxiliary contact module						
Main contact—make contact	10g	10g	10g	10g	10g	10g
Main contact—break/make contact	10/8g	10/8g	10/8g	10/8g	—	—
Contactor with auxiliary contact module						
Main contact—make contact	10g	10g	10g	10g	10g	10g
Main contact—make/break contact	20/20g	20/20g	20/20g	20/20g	20/20g	20/20g
Climatic proofing	①	①	①	①	①	①
Pollution degree	III/3	III/3	III/3	III/3	III/3	III/3

**Note**

① Damp heat, constant, to IEC 60 068-2-78; damp heat, cyclic, to IEC 60 068-2-30.

## XT Miniature Controls—Magnet Systems

Description	XTMC6A_ AC Coils	DC Coils	XTMC9A_ AC Coils	DC Coils	XTMF9A_ AC Coils	DC Coils
<b>Voltage Tolerance</b>						
Pickup (x U <sub>c</sub> )						
Single-voltage coil 50 Hz and dual-voltage coil 50 Hz, 60 Hz	0.8–1.1	—	0.8–1.1	—	0.8–1.1	—
Dual frequency coil 50/60 Hz	0.85–1.1	—	0.85–1.1	—	0.85–1.1	—
DC operated <sup>①</sup>	—	0.8–1.1	—	0.8–1.1	—	0.85–1.1
<b>Power Consumption</b>						
AC operation						
Pickup VA						
Single-voltage coil 50 Hz and dual-voltage coil 50 Hz, 60 Hz	25	—	25	—	25	—
Dual frequency coil 50/60 Hz at 50 Hz	30	—	30	—	30	—
Dual frequency coil 50/60 Hz at 60 Hz	29	—	29	—	29	—
Pickup W						
Single-voltage coil 50 Hz and dual-voltage coil 50 Hz, 60 Hz	22	—	22	—	22	—
Dual frequency coil 50/60 Hz at 50 Hz	26	—	26	—	26	—
Dual frequency coil 50/60 Hz at 60 Hz	24	—	24	—	24	—
Sealing VA						
Single-voltage coil 50 Hz and dual-voltage coil 50 Hz, 60 Hz	4.6	—	4.6	—	4.6	—
Dual frequency coil 50/60 Hz at 50 Hz	5.4	—	5.4	—	5.4	—
Dual frequency coil 50/60 Hz at 60 Hz	3.9	—	3.9	—	3.9	—
Sealing W						
Single-voltage coil 50 Hz and dual-voltage coil 50 Hz, 60 Hz	1.3	—	1.3	—	1.3	—
Dual frequency coil 50/60 Hz at 50 Hz	1.6	—	1.6	—	1.6	—
Dual frequency coil 50/60 Hz at 60 Hz	1.1	—	1.1	—	1.1	—
DC operated <sup>①</sup>						
Power consumption pickup = sealing (VA/W)	—	2.6	—	2.6	—	2.6
Duty factor (%)	100	100	100	100	100	100
<b>Switching Time at 100% U<sub>c</sub></b>						
Make contact						
Closing delay min. (ms)	14	26	14	26	14	26
Closing delay max. (ms)	21	35	21	35	21	35
Opening delay min. (ms)	8	15	8	15	8	15
Opening delay max. (ms)	18	25	18	25	18	25
Closing delay with top-mounting auxiliary contact (ms)	Max. 45	Max. 70	Max. 45	Max. 70	Max. 45	Max. 70
<b>Reversing Contactors</b>						
Changeover time at 100% U <sub>c</sub>						
Minimum (ms)	16	40	16	40	16	40
Maximum (ms)	21	50	21	50	21	50
Arcing time at 690 Vac (ms)	Max. 12	Max. 12	Max. 12	Max. 12	Max. 12	Max. 12

**Note**

<sup>①</sup> Smoothed DC or three-phase bridge rectifier.

## XT Miniature Controls

Description	XTMC6A_ AC Coils	DC Coils	XTMC9A_ AC Coils	DC Coils	XTMF9A_ AC Coils	DC Coils
<b>AC-1 Operation</b>						
Conventional free air thermal current, three-pole, 50–60 Hz (A)						
at 40°C ( $I_{th}$ )	22	22	22	22	22	22
at 50°C ( $I_{th}$ )	20	20	20	20	20	20
at 55°C ( $I_{th}$ )	19	19	19	19	19	19
Conventional free air thermal current, single-pole ( $I_{th}$ )	50	50	50	50	60	60
<b>AC-3 Operation</b>						
Rated operational current, 50/60 Hz <sup>①</sup> ( $I_g$ ) in amperes (A)						
220/230V	6.6	6.6	9.0	9.0	9.0	9.0
240V	6.6	6.6	9.0	9.0	9.0	9.0
380/400V	6.6	6.6	9.0	9.0	9.0	9.0
415V	6.6	6.6	9.0	9.0	9.0	9.0
440V	6.6	6.6	9.0	9.0	9.0	9.0
500V	5.0	5.0	6.4	6.4	6.4	6.4
660/690V	3.5	3.5	4.8	4.8	4.8	4.8
Rated power (P) in kilowatts (kW)						
220/230V	1.5	1.5	2.2	2.2	2.2	2.2
240V	1.8	1.8	2.5	2.5	2.5	2.5
380/400V	3.0	3.0	4.0	4.0	4.0	4.0
415V	3.1	3.1	4.3	4.3	4.3	4.3
440V	3.3	3.3	4.6	4.6	4.6	4.6
500V	3.0	3.0	4.0	4.0	4.0	4.0
660/690V	3.0	3.0	4.0	4.0	4.0	4.0
<b>AC-4 Operation</b>						
Rated operational current, 50/60 Hz <sup>①</sup> ( $I_g$ ) in amperes (A)						
220/230V	5.0	5.0	6.6	6.6	6.6	6.6
240V	5.0	5.0	6.6	6.6	6.6	6.6
380/400V	5.0	5.0	6.6	6.6	6.6	6.6
415V	5.0	5.0	6.6	6.6	6.6	6.6
440V	5.0	5.0	6.6	6.6	6.6	6.6
500V	3.7	3.7	5.0	5.0	5.0	5.0
660/690V	2.9	2.9	3.4	3.4	3.4	3.4
Rated power (P) in kilowatts (kW)						
220/230V	1.1	1.1	1.5	1.5	1.5	1.5
240V	1.3	1.3	1.8	1.8	1.8	1.8
380/400V	2.2	2.2	3.0	3.0	3.0	3.0
415V	2.3	2.3	3.1	3.1	3.1	3.1
440V	2.4	2.4	3.3	3.3	3.3	3.3
500V	2.2	2.2	3.0	3.0	3.0	3.0
660/690V	2.2	2.2	3.0	3.0	3.0	3.0
<b>DC-1 Operation</b> <sup>②</sup>						
12V	20	20	20	20	—	—
24V	20	20	20	20	—	—
60V	20	20	20	20	—	—
110V	20	20	20	20	—	—
220V	20	20	20	20	—	—

**Notes**

① At maximum permissible ambient temperature.

② Rated operation current ( $I_g$ ) in amperes, at maximum permissible ambient temperature.

## XT Miniature Controls, continued

Description	XTMC6A_ AC Coils	DC Coils	XTMC9A_ AC Coils	DC Coils	XTMF9A_ AC Coils	DC Coils
<b>DC-3 Operation</b> ①						
12V	6	6	8	8	—	—
24V	6	6	8	8	—	—
60V	3	3	4	4	—	—
110V	2	2	3	3	—	—
220V	—	—	—	—	1.0	1.0
<b>DC-4 Operation</b> ①						
12V	1.8	1.8	2.5	2.5	—	—
24V	1.8	1.8	2.5	2.5	—	—
60V	1.8	1.8	2.5	2.5	—	—
110V	1.1	1.1	1.5	1.5	2.5	2.5
220V	0.2	0.2	0.3	0.3	1.0	1.0
<b>Current Heat Loss (Three- or Four-Pole) in Watts</b>						
at $I_{th}$	2.0	3.5	2.0	3.5	2.7	4.7
at $I_e$ to AC-3/400V	0.3	0.4	0.5	0.7	—	—

## XT Miniature Controls—Auxiliary Contacts

Description	Built-In Auxiliary XTMC	Add-On Auxiliary XTMCF_
Interlocked opposing contacts to ZH1/457, including auxiliary contact module	Yes	Yes
Rated impulse withstand voltage, $U_{imp}$ (Vac)	6000	6000
Overvoltage category/pollution degree	III/3	III/3
Rated insulation voltage, $U_i$ (Vac)	690	690
Rated operational voltage, $U_e$ (Vac)	600	600
Safe isolation to VDE 0106 Part 101 and Part 101(A) in Vac		
Between coil and auxiliary contacts	300	300
Between the auxiliary contacts	300	300
Rated operational current		
AC-15, $I_e$		
220/240V	6A	4A
380/415V	3A	2A
500V	1.5A	1.5A
DC-13 (contacts in series)		
1: 24V	2.5A	2.5A
2: 60V	2.5A	2.5A
3: 100V	1.5A	1.5A
3: 220V	0.5A	0.5A
Conventional thermal current, $I_{th}$	10A	10A
Control circuit reliability (at $U_e = 24$ Vdc, $U_{min} = 17$ V, $I_{min} = 5.4$ mA)	<10 <sup>-8</sup> , <1 failure at 100 million operations	<10 <sup>-8</sup> , <1 failure at 100 million operations
Component lifespan at $U_e = 240$ V		
AC-15, operations x 10 <sup>6</sup>	0.2	0.2
DC-13 L/R = 50 ms: 2 contacts in series at $I_e = 0.5$ A, operations x 10 <sup>6</sup>	0.15	0.15
Short-circuit rating without welding		
Short-circuit protection rating maximum fuse, 500V gG/gL	6A	6A
Short-circuit protection rating maximum fuse, 500V fast	10A	10A
Current heat loss at conventional free air thermal current $I_{th}$ per contact, W	0.2	0.2

**Note**

① Rated operation current ( $I_e$ ) in amperes, at maximum permissible ambient temperature.

#### 1

### Wiring Diagrams

**XTMR Reversing Contactor Control Circuit**

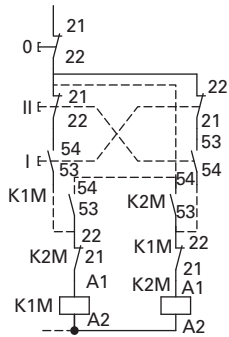

**XTMR Reversing Contactor Power Circuit**

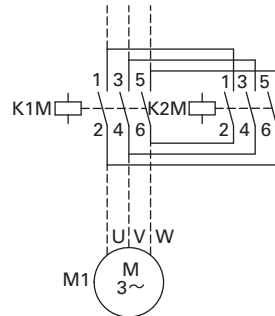

**XT Mini Star-Delta (Wye-Delta) Contactor Power Circuit**

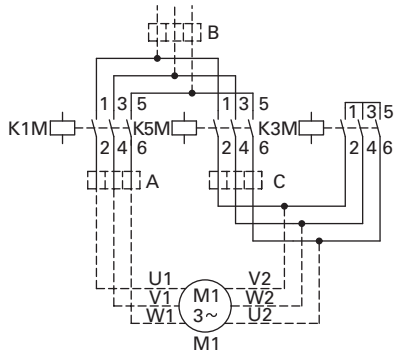

### Tripping Characteristics

**Tripping Characteristics Chart**

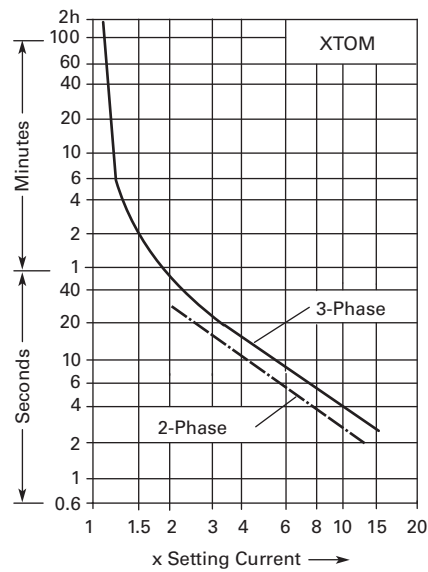

These tripping characteristics are mean values of the spread at 20°C ambient temperature in a cold state. Tripping time depends on response current. With devices at operating temperature, the tripping time of the overload relay reduces to approximately 25% of the read off value. Specific characteristics for each individual setting range can be found on **Page V5-T1-33**.



**Electrical Switching Operation Charts**

Squirrel cage motors

Operating characteristics

Starting: from rest

Stopping: after attaining a full running speed

Electrical characteristics

Make (NO): Up to 6x rated motor current

Breaking (NC): 1x rated motor current

Squirrel cage motors

Operating characteristics

Jogging, plugging, reversing

Electrical characteristics

Make (NO): 6x rated motor current

Breaking (NC): 6x rated motor current

**Normal Switching Duty—AC-3/400V**

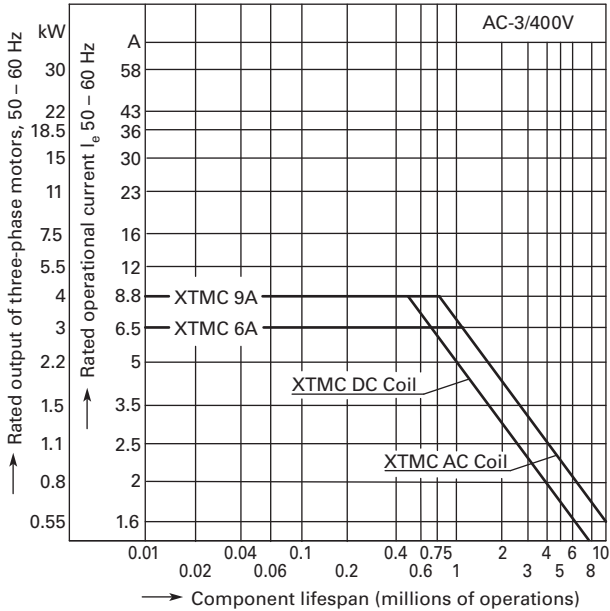

**Extreme Switching Duty—AC-4/400V**

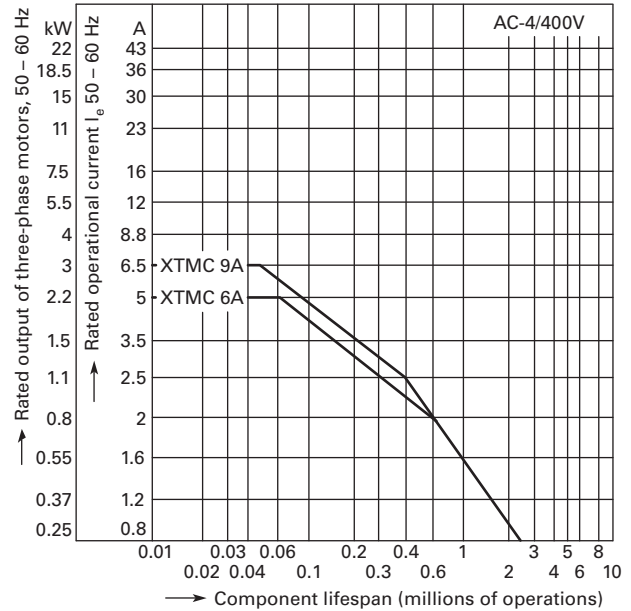

**Switching Duty for Non-Motor Loads, Three- and Four-Pole—AC-1/400V**

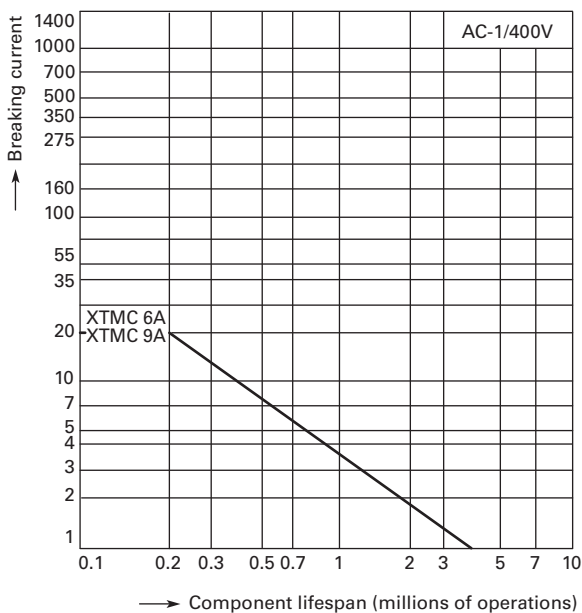

**Short Time Loading, Three-Pole—AC-1/400V (time interval between two loading cycles: 15 minutes)**

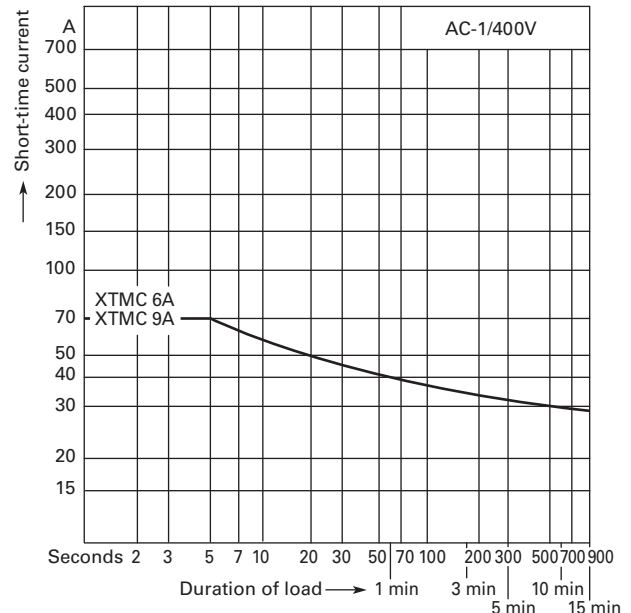

#### 1

### Dimensions

Approximate Dimensions in mm [in.]

#### Non-Reversing Mini Contactor

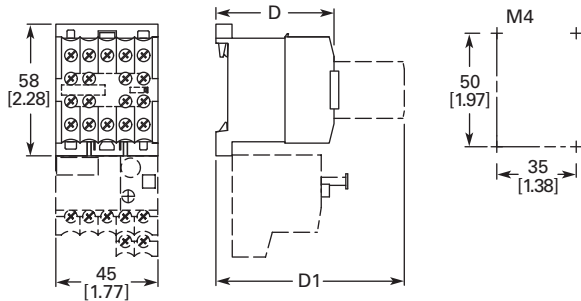

	XTMC	XTMCC
D	52 [2.05]	54 [2.13]
D1	83 [3.27]	86 [3.39]

#### Non-Reversing Mini Contactor with Overload Relay

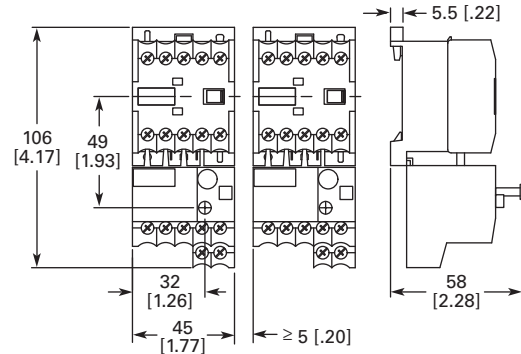

#### Star-Delta Starter Combinations

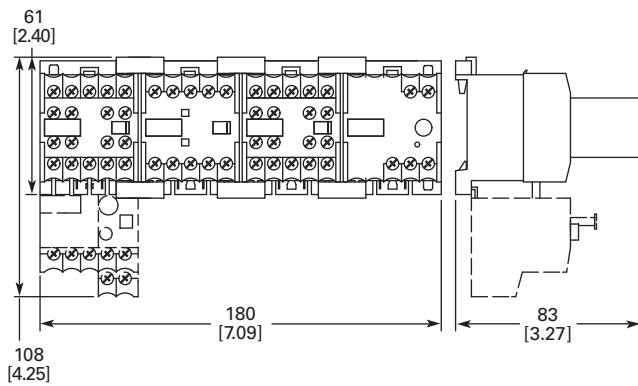

#### XTMCXRSA, XTMCXVSA Mini Suppressors

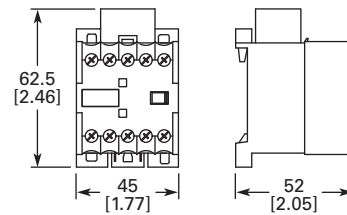

#### XTMCXTSA Mini Sealable Shroud

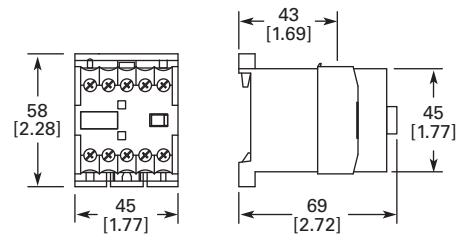

#### Reversing Mini Contactor

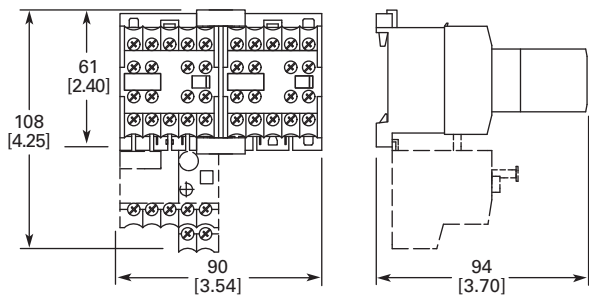

#### XTMCXML Mechanical Interlock

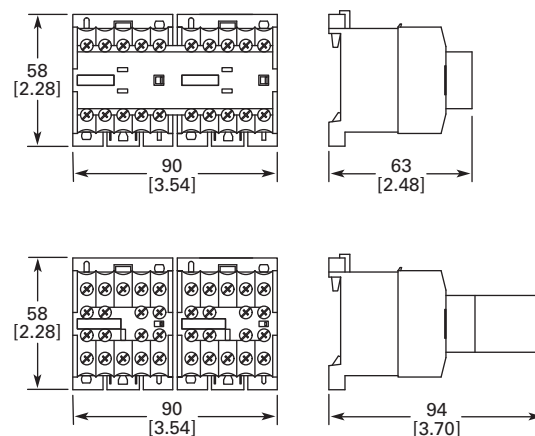

## XT Family of Contactors



## Contactors and Starters

## Product Description

The Eaton **XT** contactors and starters includes non-reversing and reversing contactors, overload relays and a variety of related accessories. Because **XT** meets IEC, UL®, CSA® and CE standards, it is the perfect product solution for IEC applications all over the world. The compact, space saving and easy to install **XT** line of IEC contactors and starters is the efficient and effective solution for customer applications from 7A to 2450A.

## Application Description

The **XT** line of IEC power control was engineered to provide highly effective control and protection for a variety of loads, including motors, compressors, pumps, resistive, capacitor banks, isolation, and others. **XT** also includes IEC ratings for lighting applications as well.

**XT** contactors can be used in safety applications according to EN 954-1, EN ISO 13849-1 and IEC 62061 up to Category 4, PL e and SIL 3. Information concerning safety related characteristics (B10 and B10d values) is available online. The auxiliary contact modules and built-in auxiliary contacts meet IEC EN 60947-5-1 Annex L (positively driven) and IEC EN 60947-4-1 Annex F (mirror contacts).

## Reference

Refer to **Volume 10—Enclosed Control**, CA08100012E, Tab 3, section 3.1 for additional Product information on IEC Non-Metallic Enclosed Contactors and Starters.

## Contents

<i>Description</i>	<i>Page</i>
Relays and Timers . . . . .	V5-T1-3
Miniature Controls . . . . .	V5-T1-18
Contactors and Starters	
Product Identification . . . . .	V5-T1-36
Catalog Number Selection . . . . .	V5-T1-38
Product Selection . . . . .	V5-T1-39
Accessories . . . . .	V5-T1-65
Technical Data and Specifications . . . . .	V5-T1-78
Wiring Diagrams . . . . .	V5-T1-109
Dimensions . . . . .	V5-T1-114
 An Eaton Green Solution	
Thermal Overload Relays . . . . .	V5-T1-128
C440/ <b>XT</b> Electronic Overload Relay . . . . .	V5-T1-141
Manual Motor Protectors . . . . .	V5-T1-157
Combination Motor Controllers . . . . .	V5-T1-193
<b>XT</b> Electronic Manual Motor Protector . . . . .	V5-T1-216
Reference Data . . . . .	V5-T1-229

## Features and Benefits

- AC control from 12V to 600V 50/60 Hz
- DC control from 12V to 220V
- Available with screw or spring cage terminals
- Reversing or non-reversing contactors and starters
- AC-3 contactor ratings to 1000A and AC-1 contactor ratings to 2000A
- Non-reversing starters to 650A
- Panel or DIN rail mounting to 65A
- IP20 finger and back-of-hand proof
- Large ambient temperature range, -25 to 50°C [-13 to 122°F]
- AC and DC controlled contactors in the same compact frame
- Low power consumption AC and DC coils
- Built-in NO or NC auxiliary contacts to 32A
- Plug-in accessories for reduced installation time
- Coil replacement on Frames C-N (18–820A)
- Contact replacement on Frames D-N (40 –820A)
- Integrated suppressor 7–150A DC operated contactors and 185–2000A AC and DC operated contactors

## Standards and Certifications

- IEC EN 60947
- CE approved
- UL
- CSA
- ATEX
- RoHS



**Note:** For Type 2 Coordination, see **Page V5-T1-230**.

## Product Identification

## XTCE007B to XTCE170G (7 to 170A) Contactors

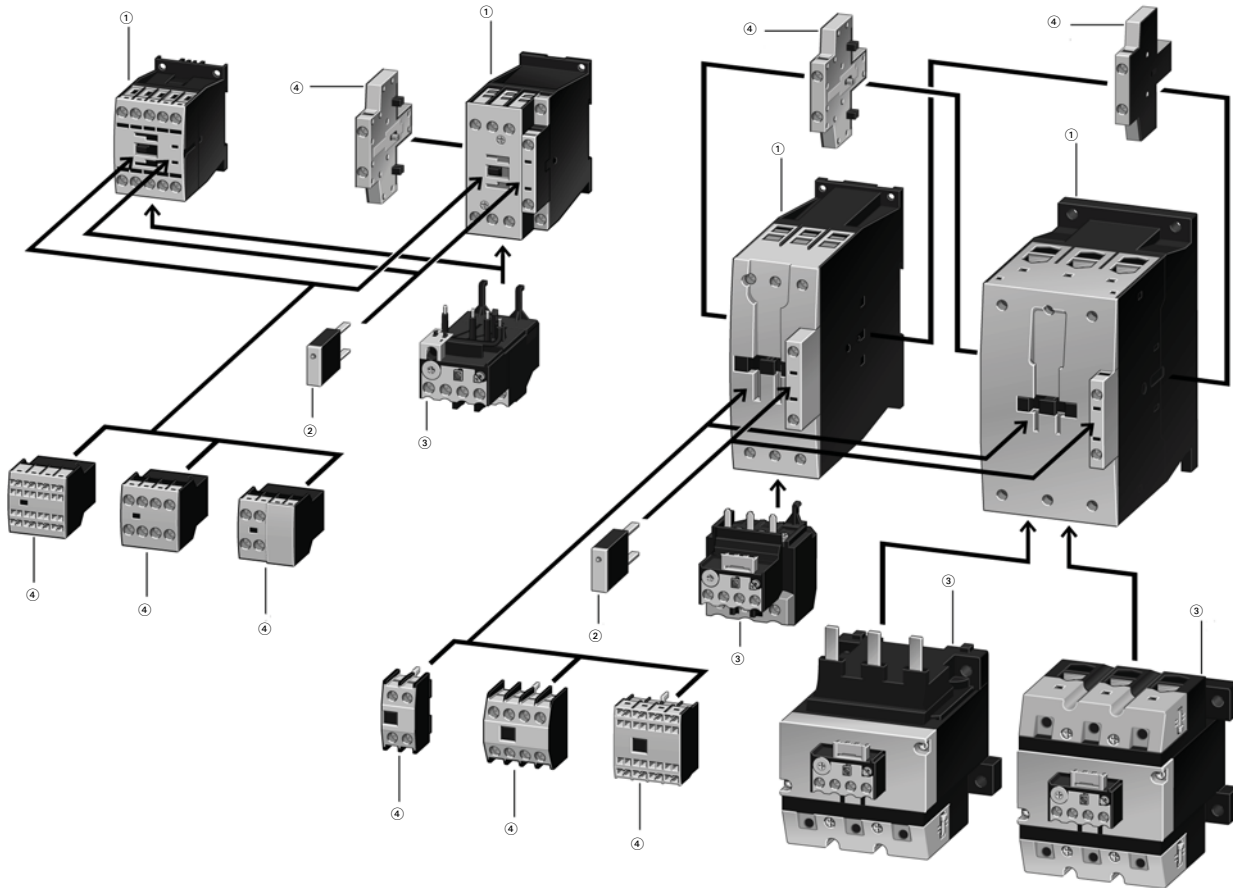

## Notes

## ① Contactor up to 170A AC-3 (see Page V5-T1-39)

AC: 12–600V, 50, 60, 50/60 Hz  
 $0.8–1.1 \times U_c$

DC: 12–250V

XTCE...B\_ (7–15A):  $0.8–1.1 \times U_c$

XTCE...C\_–XTCE...G\_ (18–150A):  $0.7–1.2 \times U_c$

24V:  $0.7–1.3 \times U_c$  at 40°C without additional auxiliary contacts

Coils for special voltages

"Safe Isolation" to IEC 536 between coil and contacts

## ② Suppressors (see Page V5-T1-71)

RC suppressor

Varistor suppressor

Free-wheel diode suppressor

## ③ Overload Relays (see Page V5-T1-130)

Can be mounted directly

Separate mounting, possible

Protection of EEx e-motors

## ④ Auxiliary Contact Modules (see Page V5-T1-24)

Two-pole, plug-in type

Four-pole, plug-in type

Overlapping contacts

Two-pole, side-mounting

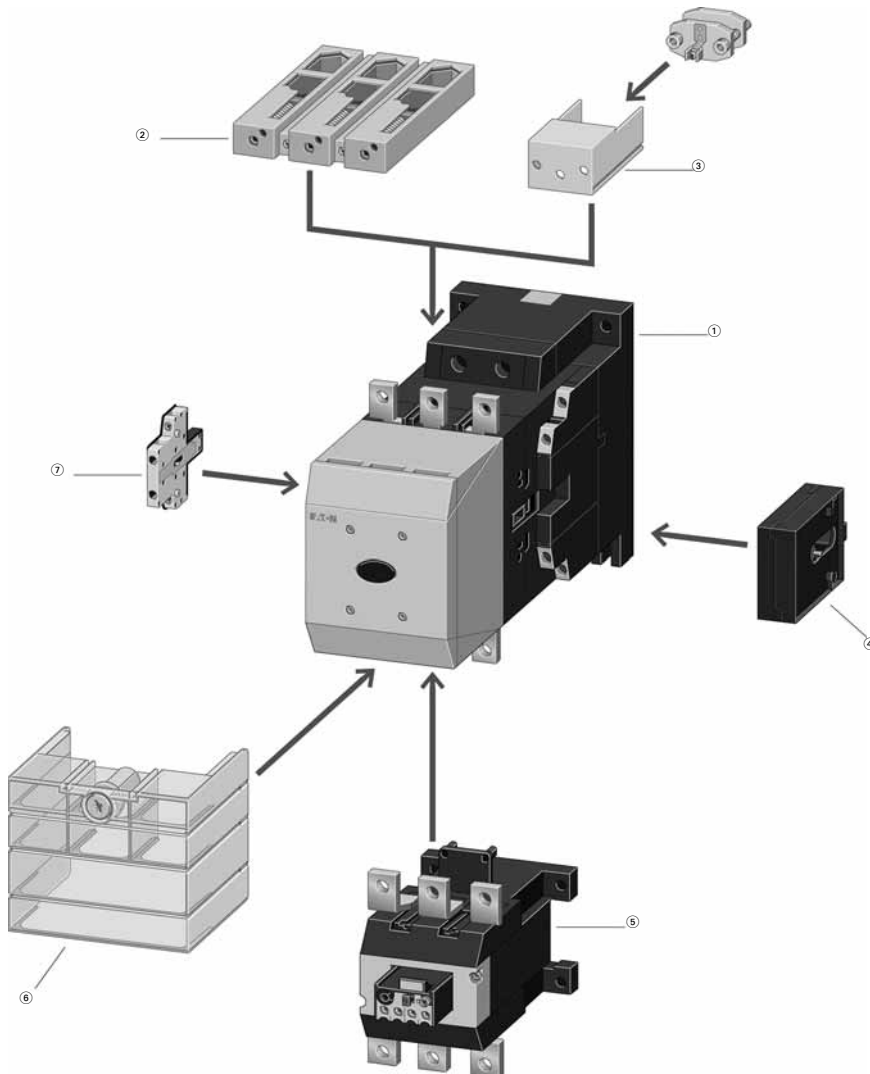
**XTCE185–XTCE20 Contactors****Notes**① **XTCE Contactors for 185–2000A**(see [Page V5-T1-46](#))

Multi-voltage coils:

24–48 Vdc

48–110 Vac/Vdc

110–250 Vac/Vdc

250–500 Vac

0.7–1.15 x U<sub>c</sub>

Actuation options:

Directly

From the PLC

With low-consumption contact

② **XTCS Contactors for 185–570A AC-3**(see [Page V5-T1-42](#))

Control voltages:

110–120V 50/60 Hz

220–240V 50/60 Hz

Conventional operation

② **Cable Terminal Block**(see [Page V5-T1-97](#))

One or two conductors per phase

Round and flat conductor connectable

Finger-proof

③ **Flat Strip Conductor Terminals**(see [Page V5-T1-97](#))

One or two strips per phase

Control circuit terminal

Cover for fingerproofing

④ **Mechanical Interlock**(see [Page V5-T1-73](#))

Fits between contactors

⑤ **Overload Relays**(see [Page V5-T1-130](#))

Can be mounted directly

Separate mounting, possible

Protection of EEx e-motors

PTB certificate

⑥ **Terminal Shroud**(see [Page V5-T1-75](#))

Finger-proof

⑦ **Auxiliary Contact Modules**(see [Page V5-T1-24](#))

Two-pole, side-mounting

### Catalog Number Selection

#### XT IEC Contactors and Starters

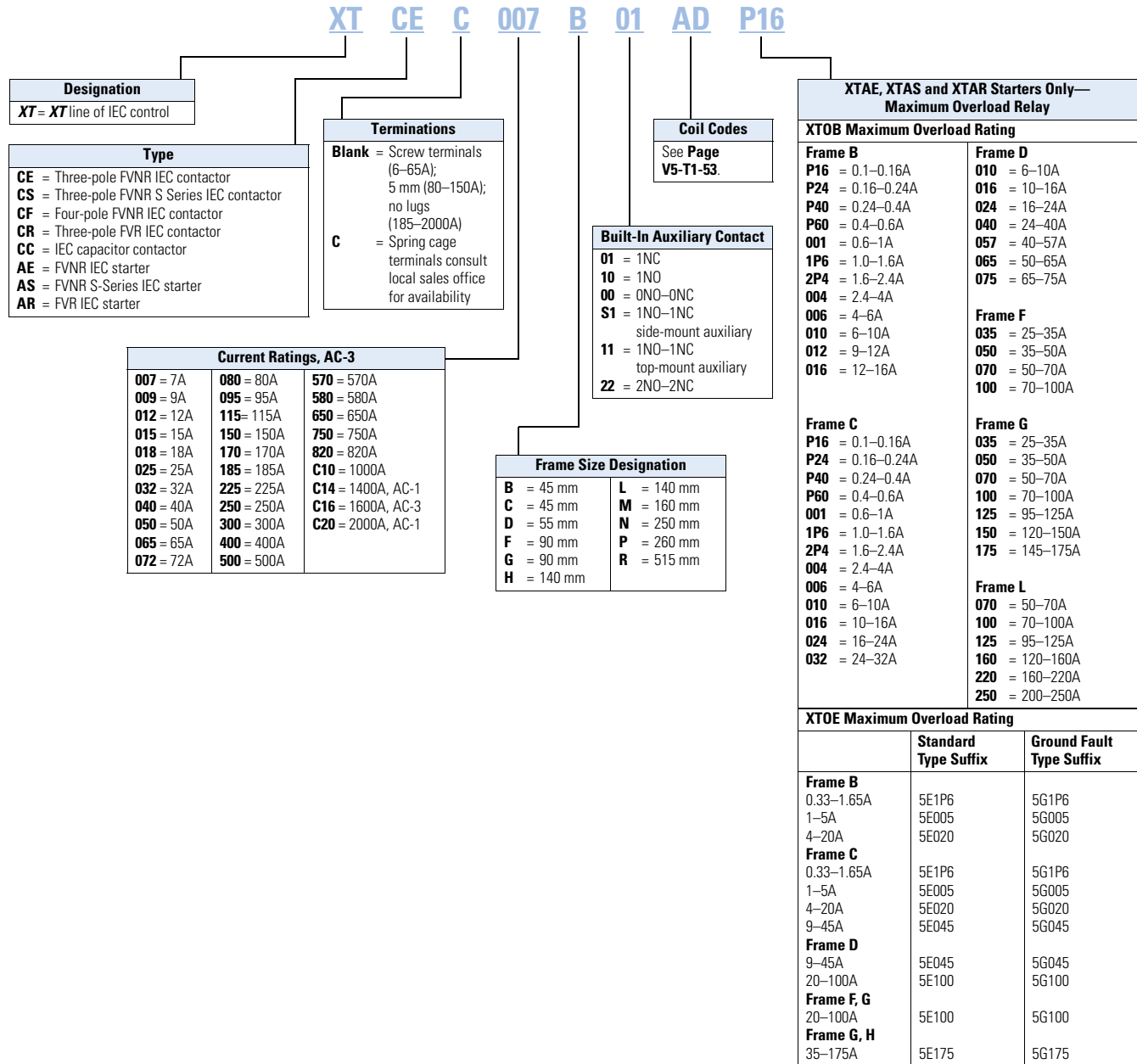

## Product Selection

## Full Voltage, Non-Reversing Contactors

## Frame B



## Three-Pole Contactors, Frame B—UL/CSA Ratings

UL General Purpose Ampere Rating	Single-Phase hp Ratings			Three-Phase hp Ratings				Auxiliary Contacts	Screw Terminal Catalog Number <sup>①②</sup>
	115V	200V	230V	200V	230V	460V	575V		
20	1/4	3/4	1	1-1/2	2	3	5	1NO	XTCE007B10_
20	1/4	3/4	1	1-1/2	2	3	5	1NC	XTCE007B01_
20	1/2	1	1-1/2	3	3	5	7-1/2	1NO	XTCE009B10_
20	1/2	1	1-1/2	3	3	5	7-1/2	1NC	XTCE009B01_
20	1	2	2	3	3	10 <sup>③</sup>	10	1NO	XTCE012B10_
20	1	2	2	3	3	10 <sup>③</sup>	10	1NC	XTCE012B01_
20	1	2	3	5	5	10 <sup>③</sup>	10	1NO	XTCE015B10_
20	1	2	3	5	5	10 <sup>③</sup>	10	1NC	XTCE015B01_

## Three-Pole Contactors, Frame B—IEC Ratings

AC-3 I <sub>e</sub> (A)	AC-1 (40°C) I <sub>e</sub> = I <sub>th</sub> (A)	Maximum kW Ratings AC-3/Three-Phase Motors 50–60 Hz				Auxiliary Contacts	Screw Terminal Catalog Number <sup>①②</sup>
		220/230V	380/400V	415V	660/690V		
7	22	2.2	3	4	3.5	1NO	XTCE007B10_
7	22	2.2	3	4	3.5	1NC	XTCE007B01_
9	22	2.5	4	5.5	4.5	1NO	XTCE009B10_
9	22	2.5	4	5.5	4.5	1NC	XTCE009B01_
12	22	3.5	5.5	7	6.5	1NO	XTCE012B10_
12	22	3.5	5.5	7	6.5	1NC	XTCE012B01_
15.5	22	4	7.5	8	7	1NO	XTCE015B10_
15.5	22	4	7.5	8	7	1NC	XTCE015B01_

## Notes

The 7–32A XTCE contactors have positively driven contacts between the integrated auxiliary contact and the auxiliary contact module as well as within the auxiliary contact modules.

DC operated contactors (Frames B–G, 7–150A) have a built-in suppressor circuit.

① Underscore ( \_ ) indicates magnet coil suffix required. See **Page V5-T1-53**.

② For spring cage terminals, insert **C** after the fourth digit of the catalog number. Example: XTCE**C**007B10A.

For 7–12A XTCEC contactors, the power, auxiliary and coil terminals are spring cage.

For 18–32A XTCEC contactors, the auxiliary and coil terminals are spring cage.

For 40–150A XTCEC contactors, the coil terminals only are spring cage.

③ For electrical life contactor application data. See **Page V5-T1-45**.

1

Frame C



#### Three-Pole Contactors, Frame C—UL/CSA Ratings

UL General Purpose Ampere Rating	Single-Phase hp Ratings			Three-Phase hp Ratings				Auxiliary Contacts	Screw Terminal Catalog Number <sup>①②</sup>
	115V	200V	230V	200V	230V	460V	575V		
40	2	2	3	5	5	10	15	1NO	XTCE018C10_
40	2	2	3	5	5	10	15	1NC	XTCE018C01_
40	2	3	5	7-1/2	10	15	20	1NO	XTCE025C10_
40	2	3	5	7-1/2	10	15	20	1NC	XTCE025C01_
40	3	5	5	10	10	20	25	1NO	XTCE032C10_
40	3	5	5	10	10	20	25	1NC	XTCE032C01_

#### Three-Pole Contactors, Frame C—IEC Ratings

AC-3 I <sub>e</sub> (A)	AC-1 (40°C) I <sub>e</sub> = I <sub>th</sub> (A)	Maximum kW Ratings AC-3/Three-Phase Motors 50–60 Hz				Auxiliary Contacts	Screw Terminal Catalog Number <sup>①②</sup>
		220/230V	380/400V	415V	660/690V		
18	40	5	7.5	10	11	1NO	XTCE018C10_
18	40	5	7.5	10	11	1NC	XTCE018C01_
25	45	7.5	11	14.5	14	1NO	XTCE025C10_
25	45	7.5	11	14.5	14	1NC	XTCE025C01_
32	45	10	15	18	17	1NO	XTCE032C10_
32	45	10	15	18	17	1NC	XTCE032C01_

Frame D



#### Three-Pole Contactors, Frame D—UL/CSA Ratings

UL General Purpose Ampere Rating	Single-Phase hp Ratings			Three-Phase hp Ratings				Auxiliary Contacts	Screw Terminal Catalog Number <sup>①②</sup>
	115V	200V	230V	200V	230V	460V	575V		
63	3	5	7-1/2	10	15	30	40	—	XTCE040D00_
63	3	5	7-1/2	10	15	30	40	1NO-1NC	XTCE040DS1_
80	3	7-1/2	10	15	20	40	50	—	XTCE050D00_
80	3	7-1/2	10	15	20	40	50	1NO-1NC	XTCE050DS1_
88	5	10	15	20	25	50	60	—	XTCE065D00_
88	5	10	15	20	25	50	60	1NO-1NC	XTCE065DS1_
88	5	10	15	20	25	50	60	—	XTCE072D00_
88	5	10	15	20	25	50	60	1NO-1NC	XTCE072DS1_

#### Three-Pole Contactors, Frame D—IEC Ratings

AC-3 I <sub>e</sub> (A)	AC-1 (40°C) I <sub>e</sub> = I <sub>th</sub> (A)	Maximum kW Ratings AC-3/Three-Phase Motors 50–60 Hz				Auxiliary Contacts	Screw Terminal Catalog Number <sup>①②</sup>
		220/230V	380/400V	415V	660/690V		
40	60	12.5	18.5	24	23	—	XTCE040D00_
40	60	12.5	18.5	24	23	1NO-1NC	XTCE040DS1_
50	80	15.5	22	30	30	—	XTCE050D00_
50	80	15.5	22	30	30	1NO-1NC	XTCE050DS1_
65	98	20	30	39	35	—	XTCE065D00_
65	98	20	30	39	35	1NO-1NC	XTCE065DS1_
72	98	22	37	41	35	—	XTCE072D00_
72	98	22	37	41	35	1NO-1NC	XTCE072DS1_

#### Notes

The 7–32A XTCE contactors have positively driven contacts between the integrated auxiliary contact and the auxiliary contact module as well as within the auxiliary contact modules.

The 40–65A XTCE contactors have positively driven contacts within the auxiliary contact module.

Six auxiliary contacts are possible with a combination of side-mounted and front-mount auxiliary contacts.

DC operated contactors (Frames B–G, 7–150A) have a built-in suppressor circuit.

<sup>①</sup> Underscore (\_) indicates magnet coil suffix required. See **Page V5-T1-53**.

<sup>②</sup> For spring cage terminals, insert **C** after the fourth digit of the catalog number. Example: XTCEC007B10A.

For 7–12A XTCEC contactors, the power, auxiliary and coil terminals are spring cage.

For 18–32A XTCEC contactors, the auxiliary and coil terminals are spring cage.

For 40–150A XTCEC contactors, the coil terminals only are spring cage.



Frame F



## Three-Pole Contactors, Frame F—UL/CSA Ratings

UL General Purpose Ampere Rating	Single-Phase hp Ratings			Three-Phase hp Ratings				Auxiliary Contacts	Screw Terminal Catalog Number <sup>①②</sup>
	115V	200V	230V	200V	230V	460V	575V		
125	7-1/2	15	15	25	30	60	75	—	XTCE080F00_
125	7-1/2	15	15	25	30	60	75	1NO-1NC	XTCE080FS1_
125	7-1/2	15	15	25	40	75	100	—	XTCE095F00_
125	7-1/2	15	15	25	40	75	100	1NO-1NC	XTCE095FS1_

## Three-Pole Contactors, Frame F—IEC Ratings

AC-3 I <sub>e</sub> (A)	AC-1 (40°C) I <sub>e</sub> = I <sub>th</sub> (A)	Maximum kW Ratings AC-3/Three-Phase Motors 50–60 Hz				Auxiliary Contacts	Screw Terminal Catalog Number <sup>①②</sup>
		220/230V	380/400V	415V	660/690V		
80	110	25	37	48	63	—	XTCE080F00_
80	110	25	37	48	63	1NO-1NC	XTCE080FS1_
95	130	30	45	57	75	—	XTCE095F00_
95	130	30	45	57	75	1NO-1NC	XTCE095FS1_

Frame G



## Three-Pole Contactors, Frame G—UL/CSA Ratings

UL General Purpose Ampere Rating	Single-Phase hp Ratings			Three-Phase hp Ratings				Auxiliary Contacts	Screw Terminal Catalog Number <sup>①②</sup>
	115V	200V	230V	200V	230V	460V	575V		
160	10	25	25	40	50	100	100	—	XTCE115G00_
160	10	25	25	40	50	100	100	1NO-1NC	XTCE115GS1_
180	10	25	30	40	60	125	125	—	XTCE150G00_
180	10	25	30	40	60	125	125	1NO-1NC	XTCE150GS1_
180	10	25	30	40	60	125	125	—	XTCE170G00_
180	10	25	30	40	60	125	125	1NO-1NC	XTCE170GS1_

## Three-Pole Contactors, Frame G—IEC Ratings

AC-3 I <sub>e</sub> (A)	AC-1 (40°C) I <sub>e</sub> = I <sub>th</sub> (A)	Maximum kW Ratings AC-3/Three-Phase Motors 50–60 Hz				Auxiliary Contacts	Screw Terminal Catalog Number <sup>①②</sup>
		220/230V	380/400V	415V	660/690V		
115	160	37	55	70	90	—	XTCE115G00_
115	160	37	55	70	90	1NO-1NC	XTCE115GS1_
150	190	48	75	91	96	—	XTCE150G00_
150	190	48	75	91	96	1NO-1NC	XTCE150GS1_
170	225	52	90	100	96	—	XTCE170G00_
170	225	52	90	100	96	1NO-1NC	XTCE170GS1_

## Notes

The 40–65A XTCE contactors have positively driven contacts within the auxiliary contact module.  
Six auxiliary contacts are possible with a combination of side-mounted and front-mount auxiliary contacts.  
DC operated contactors (Frames B–G, 7–150A) have a built-in suppressor circuit.

① Underscore ( \_ ) indicates magnet coil suffix required. See **Page V5-T1-53**.

② For spring cage terminals, insert **C** after the fourth digit of the catalog number. Example: XTCEC007B10A.

For 7–12A XTCEC contactors, the power, auxiliary and coil terminals are spring cage.

For 18–32A XTCEC contactors, the auxiliary and coil terminals are spring cage.

For 40–150A XTCEC contactors, the coil terminals only are spring cage.

1

#### Frame H



#### Three-Pole Contactors, Frame H (Electronic Coil)—UL/CSA Ratings

UL General Purpose Ampere Rating	Three-Phase hp Ratings				Auxiliary Contacts	Catalog Number <sup>①②</sup>
	200V	240V	480V	600V		
250	50	60	125	150	2NO-2NC	XTCE185H22_
250	60	75	150	200	2NO-2NC	XTCE225H22_

#### Three-Pole Contactors, Frame H (Electronic Coil)—IEC Ratings

AC-3 I <sub>e</sub> (A)	AC-1 (40°C) I <sub>e</sub> = I <sub>th</sub> (A)	Maximum kW Ratings AC-3/Three-Phase Motors 50–60 Hz				Auxiliary Contacts	Catalog Number <sup>①②</sup>
		220/230V	380/400V	660/690V <sup>③</sup>	1000V <sup>③</sup>		
185	337	55	90	140	108	2NO-2NC	XTCE185H22_
225	386	70	110	215	108	2NO-2NC	XTCE225H22_

#### Frame L



#### Three-Pole Contactors, Frame L—UL/CSA Ratings

UL General Purpose Ampere Rating	Three-Phase hp Ratings				Auxiliary Contacts	Catalog Number <sup>①②</sup>
	200V	230V	460V	575V		
<b>Standard Coil (110/120V, 230/240 Vac Coil Only)</b>						
300	75	100	200	250	2NO-2NC	XTCS250L22_
350	100	125	250	300	2NO-2NC	XTCS300L22_
<b>Electronic Coil</b>						
300	75	100	200	250	2NO-2NC	XTCE250L22_
350	100	125	250	300	2NO-2NC	XTCE300L22_

#### Three-Pole Contactors, Frame L—IEC Ratings

AC-3 I <sub>e</sub> (A)	AC-1 (40°C) I <sub>e</sub> = I <sub>th</sub> (A)	Maximum kW Ratings AC-3/Three-Phase Motors 50–60 Hz				Auxiliary Contacts	Catalog Number <sup>①②</sup>
		220/230V	380/400V	660/690V <sup>③</sup>	1000V <sup>③</sup>		
<b>Standard Coil (110/120V, 230/240 Vac Coil Only)</b>							
250	429	75	132	240	108	2NO-2NC	XTCS250L22_
300	490	90	160	195	132	2NO-2NC	XTCS300L22_
<b>Electronic Coil</b>							
250	429	75	132	240	108	2NO-2NC	XTCE250L22_
300	490	90	160	195	132	2NO-2NC	XTCE300L22_

#### Notes

- ① Underscore (\_) indicates magnet coil suffix required. See **Page V5-T1-53**. Terminals not included. See **Page V5-T1-75** for terminal accessories.
- ② Does not include lugs.
- ③ For 185–500A contactors at 660/690V or 1000V: Do not reverse directly.

## Frame M



## Three-Pole Contactors, Frame M—UL/CSA Ratings

UL General Purpose Ampere Rating	Three-Phase hp Ratings				Auxiliary Contacts	Catalog Number <sup>①②</sup>
	200V	230V	460V	575V		
<b>Standard Coil (110/120V, 230/240 Vac Coil Only)</b>						
450	125	150	300	400	2NO-2NC	XTCS400M22_
550	150	200	400	500	2NO-2NC	XTCS500M22_
<b>Electronic Coil</b>						
450	125	150	300	400	2NO-2NC	XTCE400M22_
550	150	200	400	500	2NO-2NC	XTCE500M22_

## Three-Pole Contactors, Frame M—IEC Ratings

AC-3 $I_e$ (A)	AC-1 (40°C) $I_e = I_{th}$ (A)	Maximum kW Ratings AC-3/Three-Phase Motors 50–60 Hz					Auxiliary Contacts	Catalog Number <sup>①②</sup>
		220/230V	380/400V	415V	660/690V <sup>③</sup>	1000V <sup>③</sup>		
<b>Standard Coil (110/120V, 230/240 Vac Coil Only)</b>								
400	612	125	200	240	344	132	2NO-2NC	XTCS400M22_
500	800	155	250	300	344	132	2NO-2NC	XTCS500M22_
<b>Electronic Coil</b>								
400	612	125	200	240	344	132	2NO-2NC	XTCE400M22_
500	800	155	250	300	344	132	2NO-2NC	XTCE500M22_

**Notes**

- ① Underscore (\_) indicates magnet coil suffix required. See **Page V5-T1-53**. Terminals not included. See **Page V5-T1-75** for terminal accessories.  
 ② Does not include lugs.  
 ③ For 185–500A contactors at 660/690V or 1000V: Do not reverse directly.

1

#### Frame N



#### Three-Pole Contactors, Frame N (Electronic Coil)—UL/CSA Ratings

UL General Purpose Ampere Rating	Three-Phase hp Ratings				Auxiliary Contacts	Catalog Number <sup>①②</sup>
	200V	230V	460V	575V		
630	200	200	400	600	2NO-2NC	XTCE580N22_ <sup>③</sup>
700	200	250	500	600	2NO-2NC	XTCE650N22_ <sup>③</sup>
800	250	300	600	700	2NO-2NC	XTCE750N22_ <sup>③</sup>
850	290	350	700	860	2NO-2NC	XTCE820N22_ <sup>③</sup>
1100	350	420	850	980	2NO-2NC	XTCEC10N22_ <sup>③</sup>

#### Three-Pole Contactors, Frame N (Electronic Coil)—IEC Ratings

AC-3 I <sub>e</sub> (A)	AC-1 (40°C) I <sub>e</sub> = I <sub>th</sub> (A)	Maximum kW Ratings AC-3/Three-Phase Motors 50–60 Hz					Auxiliary Contacts	Catalog Number <sup>①②</sup>
		220/230V	380/400V	415V	660/690V <sup>④</sup>	1000V <sup>④</sup>		
580	980	185	315	348	560	600	2NO-2NC	XTCE580N22_ <sup>③</sup>
650	1041	205	355	390	630	600	2NO-2NC	XTCE650N22_ <sup>③</sup>
750	1102	240	400	455	720	800	2NO-2NC	XTCE750N22_ <sup>③</sup>
820	1225	260	450	500	750	800	2NO-2NC	XTCE820N22_ <sup>③</sup>
1000	1225	315	560	610	1000	1000	2NO-2NC	XTCEC10N22_ <sup>③</sup>

#### Frame P



#### Three-Pole Contactors, Frame P (Electronic Coil)—UL/CSA Ratings

UL General Purpose Ampere Rating	Three-Phase hp Ratings				Auxiliary Contacts	Catalog Number <sup>①②</sup>
	200V	230V	460V	575V		
1400	—	—	—	—	2NO-2NC	XTCEC14P22_ <sup>③</sup>

#### Three-Pole Contactors, Frame P (Electronic Coil)—IEC Ratings

AC-3 I <sub>e</sub> (A)	AC-1 (40°C) I <sub>e</sub> = I <sub>th</sub> (A)	Maximum kW Ratings AC-3/Three-Phase Motors 50–60 Hz					Auxiliary Contacts	Catalog Number <sup>①②</sup>
		220/230V	380/400V	415V	660/690V <sup>④</sup>	1000V <sup>④</sup>		
—	1714	—	—	—	—	—	2NO-2NC	XTCEC14P22_ <sup>③</sup>

#### Frame R



#### Three-Pole Contactors, Frame R (Electronic Coil)—UL/CSA Ratings

UL General Purpose Ampere Rating	Three-Phase hp Ratings				Auxiliary Contacts	Catalog Number <sup>①②</sup>
	200V	230V	460V	575V		
1600	560	640	1200	1300	2NO-2NC	XTCEC16R22_ <sup>③</sup>
2000	—	—	—	—	2NO-2NC	XTCEC20R22_ <sup>③</sup>

#### Three-Pole Contactors, Frame R (Electronic Coil)—IEC Ratings

AC-3 I <sub>e</sub> (A)	AC-1 (40°C) I <sub>e</sub> = I <sub>th</sub> (A)	Maximum kW Ratings AC-3/Three-Phase Motors 50–60 Hz					Auxiliary Contacts	Catalog Number <sup>①②</sup>
		220/230V	380/400V	415V	660/690V <sup>④</sup>	1000V <sup>④</sup>		
1600	2200	500	900	900	1600	1700	2NO-2NC	XTCEC16R22_ <sup>③</sup>
—	2450	—	—	—	—	—	2NO-2NC	XTCEC20R22_ <sup>③</sup>

#### Notes

- ① Underscore ( \_ ) indicates magnet coil suffix required. See [Page V5-T1-53](#). Terminals not included. See [Page V5-T1-75](#) for terminal accessories.
- ② Does not include lugs.
- ③ When operating the 580–2000A XTCE contactors with frequency inverters, the suppressor on the load side must be removed. The load side suppressor must also be removed when performing a high-voltage test—see Pub51204, Pub51209.
- ④ For 185–500A contactors at 660/690V or 1000V: do not reverse directly.

### Contactor Application Data <sup>①②</sup>

Catalog Prefix	Electrical Life (Operations) for 10 hp, 480V (14.2A) Applications
XTCE012B	1 million
XTCE015B	1.2 million
XTCE018C	2 million

### Full Voltage Non-Reversing Three-Pole Contactors—Contact Sequence (Circuit Symbols)—Standard Offering

Contactor Frame	Auxiliary Contacts	Contact Sequence
B-C	1NO	
B-C	1NC	
D-G	—	
L-R	2NO-2NC	

### Four-Pole Contactors with Screw Terminals—Maximum UL/CSA Motor Ratings

Single-Phase hp Ratings		Three-Phase hp Ratings				Auxiliary Contacts	Contact Sequence	Catalog Number <sup>③</sup>
115V	230V	200V	230V	460V	575V			
1	2	3	3	10	10	—		XTCF020B00_
—	—	7.5	7.5	10	15	1NO		XTCF032C10_
—	—	7.5	10	15	20	1NO		XTCF045C10_
—	—	10	15	30	40	—		XTCF063D00_
—	—	15	20	40	50	—		XTCF080D00_
—	—	25	30	60	75	—		XTCF125G00_
—	—	25	40	75	100	—		XTCF160G00_
—	—	40	50	100	125	—		XTCF200G00_



### Four-Pole Contactors with Screw Terminals—Maximum IEC Ratings

AC-3 I <sub>e</sub> (A)	AC-1 (40°C)	Three-Phase hp Ratings				Auxiliary Contacts	Contact Sequence	Catalog Number <sup>③</sup>
		200V	230V	460V	575V			
12	22	3	3	10	10	—		XTCF020B00_
12	22	3.5	5.5	7	6.5	—		XTCF020B00_
18	32	5	7.5	10	11	1NO		XTCF032C10_
25	45	7.5	11	14.5	14	1NO		XTCF045C10_
40	63	12.5	18.5	24	23	—		XTCF063D00_
50	80	15.5	22	30	30	—		XTCF080D00_
80	125	25	37	48	63	—		XTCF125G00_
95	160	30	45	57	75	—		XTCF160G00_
115	200	37	55	70	90	—		XTCF200G00_

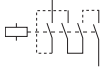

#### Notes

- ① See Page V5-T1-111 for electrical life curves.  
 ② AC and DC operated contactors have a built-in suppressor circuit (Frames L-R, 185–2000A).  
 ③ Underscore ( \_ ) indicates magnet coil suffix required. See Page V5-T1-53.

### Switching of DC Currents ①

Description	Single-Pole	Two-Pole
XTCF020B–XTCF200G >60 Vdc		

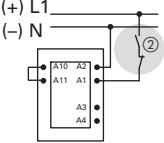
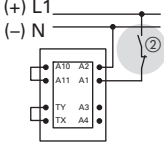
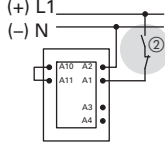
### Controlling XTCS and XTCE Contactors Frames L–R (185–2000A)

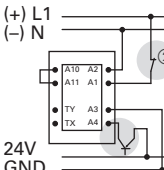
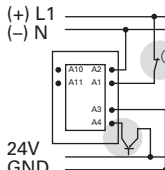
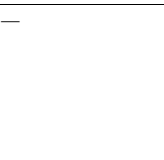
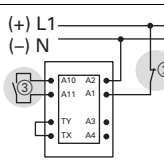
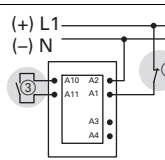
Description	XTCS250L–XTCS500M, XTCE_H	XTCEC16R, XTCEC20R	XTCE250L–XTCEC14P
<b>Conventional</b> A1/A2 are applied to voltage in the usual manner.			
<b>Direct from the PLC</b> A 24V output from the PLC can be connected directly to connections A3/A4.			
<b>From Low-Consumption Command Devices</b> Command devices, which can only be subject to minimal loads such as circuit board relays, control circuit devices or position switches can be connected directly to A10/A11.			

#### Notes

- ① When necessary, cable to be supplied by customer.
- ② Standstill in an emergency (emergency-stop).
- ③ Command device connection.

## Full Voltage, Reversing Contactors

## Frame B



## Contactors with Screw Terminals, Frame B—Maximum UL/CSA Ratings

Single-Phase hp Ratings		Three-Phase hp Ratings				Spare Auxiliary Contacts		Catalog Number ①
115V	230V	200V	230V	460V	575V	K1M	K2M	
1/4	1	1-1/2	2	3	5	—  63 —  64	—  63 —  64	XTCR007B21_
1/2	1-1/2	2	3	5	7-1/2	—  63 —  64	—  63 —  64	XTCR009B21_
1/2	2	3	3	7-1/2	10	—  63 —  64	—  63 —  64	XTCR012B21_

## Contactors with Screw Terminals, Frame B—Maximum IEC Ratings

AC-3 I <sub>e</sub> (A)	Three-Phase Motors 50–60 Hz				Spare Auxiliary Contacts		Catalog Number ①
	220/230V	380/400V	415V	660/690V	K1M	K2M	
7	2.2	3	4	3.5	—  63 —  64	—  63 —  64	XTCR007B21_
9	2.5	4	5.5	4.5	—  63 —  64	—  63 —  64	XTCR009B21_
12	3.5	5.5	7	6.5	—  63 —  64	—  63 —  64	XTCR012B21_

## Frame C



## Contactors with Screw Terminals, Frame C—Maximum UL/CSA Ratings

Single-Phase hp Ratings		Three-Phase hp Ratings				Spare Auxiliary Contacts		Catalog Number ①
115V	230V	200V	230V	460V	575V	K1M	K2M	
2	3	5	5	10	15	—  63 —  64	—  63 —  64	XTCR018C21_
2	5	7-1/2	7-1/2	15	20	—  63 —  64	—  63 —  64	XTCR025C21_
3	5	10	10	20	25	—  63 —  64	—  63 —  64	XTCR032C21_

## Contactors with Screw Terminals, Frame C—Maximum IEC Ratings

AC-3 I <sub>e</sub> (A)	Three-Phase Motors 50–60 Hz				Spare Auxiliary Contacts		Catalog Number ①
	220/230V	380/400V	415V	660/690V	K1M	K2M	
18	5	7.5	8	11	—  63 —  64	—  63 —  64	XTCR018C21_
25	7.5	11	14.5	14	—  63 —  64	—  63 —  64	XTCR025C21_
32	10	15	18	17	—  63 —  64	—  63 —  64	XTCR032C21_

## Note

① Underscore ( \_ ) indicates magnet coil suffix required. See Page V5-T1-53.

1

#### Frame D

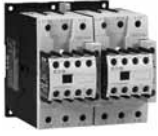

#### Contactors with Screw Terminals, Frame D—Maximum UL/CSA Ratings

Single-Phase hp Ratings		Three-Phase hp Ratings				Spare Auxiliary Contacts		Catalog Number ①
115V	230V	200V	230V	460V	575V	K1M	K2M	
3	7-1/2	10	15	30	40	—	—	XTCR040D11_
3	10	15	20	40	50	—	—	XTCR050D11_
5	15	20	25	50	60	—	—	XTCR065D11_

#### Contactors with Screw Terminals, Frame D—Maximum IEC Ratings

AC-3 I <sub>e</sub> (A)	Three-Phase Motors 50–60 Hz				Spare Auxiliary Contacts		Catalog Number ①
	220/230V	380/400V	415V	660/690V	K1M	K2M	
40	12.5	18.5	24	23	—	—	XTCR040D11_
50	15.5	22	30	30	—	—	XTCR050D11_
65	20	30	39	35	—	—	XTCR065D11_

#### Frame F

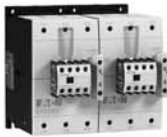

#### Contactors with Screw Terminals, Frame F—Maximum UL/CSA Ratings

Single-Phase hp Ratings		Three-Phase hp Ratings				Spare Auxiliary Contacts		Catalog Number ①
115V	230V	200V	230V	460V	575V	K1M	K2M	
7-1/2	15	25	30	60	75	—	—	XTCR080F11_
7-1/2	15	25	40	75	100	—	—	XTCR095F11_

#### Contactors with Screw Terminals, Frame F—Maximum IEC Ratings

AC-3 I <sub>e</sub> (A)	Three-Phase Motors 50–60 Hz				Spare Auxiliary Contacts		Catalog Number ①
	220/230V	380/400V	415V	660/690V	K1M	K2M	
80	25	37	48	63	—	—	XTCR080F11_
95	30	45	57	75	—	—	XTCR095F11_

#### Frame G



#### Contactors with Screw Terminals, Frame G—Maximum UL/CSA Ratings

Single-Phase hp Ratings		Three-Phase hp Ratings				Spare Auxiliary Contacts		Catalog Number ①
115V	230V	200V	230V	460V	575V	K1M	K2M	
10	25	40	50	100	100	—	—	XTCR115G11_
15	30	40	60	100	100	—	—	XTCR150G11_

#### Contactors with Screw Terminals, Frame G—Maximum IEC Ratings

AC-3 I <sub>e</sub> (A)	Three-Phase Motors 50–60 Hz				Spare Auxiliary Contacts		Catalog Number ①
	220/230V	380/400V	415V	660/690V	K1M	K2M	
115	37	55	70	90	—	—	XTCR115G11_
150	48	75	91	96	—	—	XTCR150G11_

**Note**

① Underscore (\_) indicates magnet coil suffix required. See Page V5-T1-53.



## XTCR Reversing Contactor Components

Quantity	Frame	B	C	D	F	G
2	Contactors	XTCE...B01_	XTCE...C01_	XTCE...D00_	XTCE...F00_	XTCE...G00_
2	Auxiliary contact	XTCEXFAC20	XTCEXFAC20	XTCEXFBG11	XTCEXFBG11	XTCEXFBG11
1	Mechanical interlock	XTCEXMLB	XTCEXMLC	XTCEXMLD	XTCEXMLG	XTCEXMLG
1	Reversing link kit	XTCEXRLB	XTCEXRLC	XTCEXRLD	XTCEXRLG	XTCEXRLG

## Magnet Coil Suffix

Coil Voltage	Suffix Code
<b>Frames A–B</b>	
110V 50 Hz, 120V 60 Hz	<b>A</b>
220V 50 Hz, 240V 60 Hz	<b>B</b>
230V 50 Hz	<b>F</b>
24V 50/60 Hz	<b>T</b>
24 Vdc	<b>TD</b>
415V 50 Hz, 480V 60 Hz	<b>C</b>
600V 60 Hz	<b>D</b>
208V 60 Hz	<b>E</b>
190V 50 Hz, 220V 60 Hz	<b>G</b>
240V 50 Hz, 277V 60 Hz	<b>H</b>
380V 50 Hz, 440V 60 Hz	<b>L</b>
400V 50 Hz	<b>N</b>
380V 60 Hz	<b>P</b>
12V 50/60 Hz	<b>R</b>
42V 50 Hz, 48V 60 Hz	<b>W</b>
48V 50 Hz	<b>Y</b>
120 Vdc	<b>AD</b>
220 Vdc	<b>BD</b>
12 Vdc	<b>RD</b>
48 Vdc	<b>WD</b>

Coil Voltage	Suffix Code
<b>Frames C–F</b>	
110V 50 Hz, 120V 60 Hz	<b>A</b>
220V 50 Hz, 240V 60 Hz	<b>B</b>
230V 50 Hz	<b>F</b>
24V 50/60 Hz	<b>T</b>
24 Vdc	<b>TD</b>
415V 50 Hz, 480V 60 Hz	<b>C</b>
600V 60 Hz	<b>D</b>
208V 60 Hz	<b>E</b>
190V 50 Hz, 220V 60 Hz	<b>G</b>
240V 50 Hz, 277V 60 Hz	<b>H</b>
380V 50 Hz, 440V 60 Hz	<b>L</b>
400V 50 Hz	<b>N</b>
380V 60 Hz	<b>P</b>
12V 50/60 Hz	<b>R</b>
42V 50 Hz, 48V 60 Hz	<b>W</b>
48V 50 Hz	<b>Y</b>
110–130 Vdc	<b>AD</b>
200–240 Vdc	<b>BD</b>
48–60 Vdc	<b>WD</b>

Coil Voltage	Suffix Code
<b>Frame G</b>	
100–120V 50/60 Hz	<b>A</b>
190–240V 50/60 Hz	<b>B</b>
24V 50/60 Hz	<b>T</b>
24–27 Vdc	<b>TD</b>
480–500V 50/60 Hz	<b>C</b>
380–440V 50/60 Hz	<b>L</b>
42–48V 50/60 Hz	<b>W</b>
110–130 Vdc	<b>AD</b>
200–240 Vdc	<b>BD</b>
48–60 Vdc	<b>WD</b>
<b>Frame H</b>	
100–120V 50/60 Hz	<b>A</b>
190–240V 50/60 Hz	<b>B</b>
480–500V 50/60 Hz	<b>C</b>
380–440V 50/60 Hz	<b>L</b>
24V 50/60Hz	<b>T</b>
42–48V 50/60Hz	<b>W</b>
110–130 Vdc	<b>AD</b>
200–240 Vdc	<b>BD</b>
24–27 Vdc	<b>TD</b>
48–60 Vdc	<b>WD</b>

Coil Voltage	Suffix Code
<b>Frames L–N</b>	
110–250 Vdc 40–60 Hz	<b>A</b>
250–500V 40–60 Hz	<b>C</b>
48–110 Vdc 40–60 Hz	<b>Y</b>
24–48 Vdc	<b>TD</b> <sup>①</sup>
<b>Frames L–M, S-Series</b>	
110–120V 50/60 Hz	<b>A</b>
220–240V 50/60 Hz	<b>B</b>
<b>Frames P–R</b>	
230–250 Vdc 50–60 Hz	<b>B</b>

**Note**

<sup>①</sup> Frames L–M only.

### Full Voltage, Non-Reversing Starters, with Bimetallic or Electronic Overload

#### Frame B



#### Three-Pole Starters, Frame B—Maximum UL/CSA Ratings ①

Single-Phase hp Ratings		Three-Phase hp Ratings				Auxiliary Contacts	Catalog Number ②③
115V	230V	200V	230V	460V	575V		
1/4	1	1-1/2	2	3	5	1NO	XTAE007B10_ _
1/4	1	1-1/2	2	3	5	1NC	XTAE007B01_ _
1/2	1-1/2	3	3	5	7-1/2	1NO	XTAE009B10_ _
1/2	1-1/2	3	3	5	7-1/2	1NC	XTAE009B01_ _
1	2	3	3	10 ④	10	1NO	XTAE012B10_ _
1	2	3	3	10 ④	10	1NC	XTAE012B01_ _
1	3	5	5	10 ④	10	1NO	XTAE015B10_ _
1	3	5	5	10 ④	10	1NC	XTAE015B01_ _

#### Three-Pole Starters, Frame B—Maximum IEC Ratings ①

AC-3 I <sub>e</sub> (A)	AC-1	Three-Phase Motors 50–60 Hz				Auxiliary Contacts	Catalog Number ②③
		220/230V	380/400V	415V	660/690V		
7	20	2.2	3	4	3.5	1NO	XTAE007B10_ _
7	20	2.2	3	4	3.5	1NC	XTAE007B01_ _
9	20	2.5	4	5.5	4.5	1NO	XTAE009B10_ _
9	20	2.5	4	5.5	4.5	1NC	XTAE009B01_ _
12	20	3.5	5.5	7	6.5	1NO	XTAE012B10_ _
12	20	3.5	5.5	7	6.5	1NC	XTAE012B01_ _
15.5	20	4	7.5	8	7	1NO	XTAE015B10_ _
15.5	20	4	7.5	8	7	1NC	XTAE015B01_ _

#### Frame C



#### Three-Pole Starters, Frame C—Maximum UL/CSA Ratings ①

Single-Phase hp Ratings		Three-Phase hp Ratings				Auxiliary Contacts	Catalog Number ②③
115V	230V	200V	230V	460V	575V		
2	3	5	5	10 ④	15	1NO	XTAE018C10_ _
2	3	5	5	10 ④	15	1NC	XTAE018C01_ _
2	5	7-1/2	7-1/2	15	20	1NO	XTAE025C10_ _
2	5	7-1/2	7-1/2	15	20	1NC	XTAE025C01_ _
3	5	10	10	20	25	1NO	XTAE032C10_ _
3	5	10	10	20	25	1NC	XTAE032C01_ _

#### Three-Pole Starters, Frame C—Maximum IEC Ratings ①

AC-3 I <sub>e</sub> (A)	AC-1	Three-Phase Motors 50–60 Hz				Auxiliary Contacts	Catalog Number ②③
		220/230V	380/400V	415V	660/690V		
18	35	5	7.5	10	11	1NO	XTAE018C10_ _
18	35	5	7.5	10	11	1NC	XTAE018C01_ _
25	40	7.5	11	14.5	14	1NO	XTAE025C10_ _
25	40	7.5	11	14.5	14	1NC	XTAE025C01_ _
32	40	10	15	18	17	1NO	XTAE032C10_ _
32	40	10	15	18	17	1NC	XTAE032C01_ _

#### Notes

- ① Products shown are with the bimetallic overload relay.
- ② Underscore ( \_ ) indicates magnet coil suffix required. See Page V5-T1-53.
- ③ Underscore ( \_ ) indicates overload relay suffix required. See Page V5-T1-54.
- ④ For electrical life contactor application data. See Page V5-T1-53.

Frame D



### Three-Pole Starters, Frame D—Maximum UL/CSA Ratings ①

Single-Phase hp Ratings		Three-Phase hp Ratings				Auxiliary Contacts	Catalog Number ②③
115V	230V	200V	230V	460V	575V		
3	7-1/2	10	15	30	40	—	XTAE040D00_ _
3	10	15	20	40	50	—	XTAE050D00_ _
5	15	20	25	50	60	—	XTAE065D00_ _

### Three-Pole Starters, Frame D—Maximum IEC Ratings ①

AC-3 I <sub>e</sub> (A)	AC-1	Three-Phase Motors 50–60 Hz				Auxiliary Contacts	Catalog Number ②③
		220/230V	380/400V	415V	660/690V		
40	50	12.5	18.5	24	23	—	XTAE040D00_ _
50	60	15.5	22	30	30	—	XTAE050D00_ _
65	72	20	30	39	35	—	XTAE065D00_ _

Frame F



### Three-Pole Starters, Frame F—Maximum UL/CSA Ratings ①

Single-Phase hp Ratings		Three-Phase hp Ratings				Auxiliary Contacts	Catalog Number ②③
115V	230V	200V	230V	460V	575V		
7-1/2	15	25	30	60	75	—	XTAE080F00_ _
7-1/2	15	25	40	75	100	—	XTAE095F00_ _

### Three-Pole Starters, Frame F—Maximum IEC Ratings ①

AC-3 I <sub>e</sub> (A)	AC-1	Three-Phase Motors 50–60 Hz				Auxiliary Contacts	Catalog Number ②③
		220/230V	380/400V	415V	660/690V		
80	110	25	37	48	63	—	XTAE080F00_ _
95	110	30	45	57	75	—	XTAE095F00_ _

Frame G



### Three-Pole Starters, Frame G—Maximum UL/CSA Ratings ①

Single-Phase hp Ratings		Three-Phase hp Ratings				Auxiliary Contacts	Catalog Number ②③
115V	230V	200V	230V	460V	575V		
10	25	40	50	100	125	—	XTAE115G00_ _
15	30	40	60	125	125	—	XTAE150G00_ _

### Three-Pole Starters, Frame G—Maximum IEC Ratings ①

AC-3 I <sub>e</sub> (A)	AC-1	Three-Phase Motors 50–60 Hz				Auxiliary Contacts	Catalog Number ②③
		220/230V	380/400V	415V	660/690V		
115	160	37	55	70	105	—	XTAE115G00_ _
150	160	48	75	91	125	—	XTAE150G00_ _

#### Notes

- ① Products shown are with the bimetallic overload relay.
- ② Underscore ( \_ ) indicates magnet coil suffix required. See [Page V5-T1-53](#).
- ③ Underscore ( \_ ) indicates overload relay suffix required. See [Page V5-T1-54](#).

**Full Voltage, Reversing Starters, with Bimetallic or Electronic Overload****Reversing Starters with Screw Terminals, Frame B—Maximum UL/CSA Ratings**

Single-Phase hp Ratings		Three-Phase hp Ratings				Catalog Number <sup>①②</sup>
115V	230V	200V	230V	460V	575V	
1/4	1	1-1/2	2	3	5	XTAR007B21__
1/2	1-1/2	3	3	5	7-1/2	XTAR009B21__
1	2	3	3	10	10	XTAR012B21__

**Reversing Starters with Screw Terminals, Frame B—Maximum IEC Ratings**

AC-3 I <sub>e</sub> (A)	Three-Phase Motors 50–60 Hz				Catalog Number <sup>①②</sup>
	220/230V	380/400V	415V	660/690V	
7	2.2	3	4	3.5	XTAR007B21__
9	2.5	4	5.5	4.5	XTAR009B21__
12	3.5	5.5	7	6.5	XTAR012B21__

**Reversing Starters with Screw Terminals, Frame C—Maximum UL/CSA Ratings**

Single-Phase hp Ratings		Three-Phase hp Ratings				Catalog Number <sup>①②</sup>
115V	230V	200V	230V	460V	575V	
2	3	5	5	10	15	XTAR018C21__
2	5	7-1/2	7-1/2	15	20	XTAR025C21__
3	5	10	10	20	25	XTAR032C21__

**Reversing Starters with Screw Terminals, Frame C—Maximum IEC Ratings**

AC-3 I <sub>e</sub> (A)	Three-Phase Motors 50–60 Hz				Catalog Number <sup>①②</sup>
	220/230V	380/400V	415V	660/690V	
18	5	7.5	8	11	XTAR018C21__
25	7.5	11	14.5	14	XTAR025C21__
32	10	15	18	17	XTAR032C21__

**Reversing Starters with Screw Terminals, Frame D—Maximum UL/CSA Ratings**

Single-Phase hp Ratings		Three-Phase hp Ratings				Catalog Number <sup>①②</sup>
115V	230V	200V	230V	460V	575V	
3	7-1/2	10	15	30	40	XTAR040D11__
3	10	15	20	40	50	XTAR050D11__
5	15	20	25	50	60	XTAR065D11__

**Reversing Starters with Screw Terminals, Frame D—Maximum IEC Ratings**

AC-3 I <sub>e</sub> (A)	Three-Phase Motors 50–60 Hz				Catalog Number <sup>①②</sup>
	220/230V	380/400V	415V	660/690V	
40	12.5	18.5	24	23	XTAR040D11__
50	15.5	22	30	30	XTAR050D11__
65	20	30	39	35	XTAR065D11__

**Notes**

① Underscore ( \_ ) indicates magnet coil suffix required. See **Page V5-T1-53**.

② Underscore ( \_ ) indicates overload relay suffix required. See **Page V5-T1-54**.

Starter Application Data <sup>①</sup>

Catalog Prefix	AC-3	Electrical Life (Operations)
XTAE012B	12A	1 million
XTAE015B	15A	1.2 million
XTAE018C	18A	2 million

## Magnet Coil Suffix

Coil Voltage	Suffix Code
<b>Frames A–B</b>	
110V 50 Hz, 120V 60 Hz	<b>A</b>
220V 50 Hz, 240V 60 Hz	<b>B</b>
230V 50 Hz	<b>F</b>
24V 50/60 Hz	<b>T</b>
24 Vdc	<b>TD</b>
415V 50 Hz, 480V 60 Hz	<b>C</b>
600V 60 Hz	<b>D</b>
208V 60 Hz	<b>E</b>
190V 50 Hz, 220V 60 Hz	<b>G</b>
240V 50 Hz, 277V 60 Hz	<b>H</b>
380V 50 Hz, 440V 60 Hz	<b>L</b>
400V 50 Hz	<b>N</b>
380V 60 Hz	<b>P</b>
12V 50/60 Hz	<b>R</b>
42V 50 Hz, 48V 60 Hz	<b>W</b>
48V 50 Hz	<b>Y</b>
120 Vdc	<b>AD</b>
220 Vdc	<b>BD</b>
12 Vdc	<b>RD</b>
48 Vdc	<b>WD</b>

Coil Voltage	Suffix Code
<b>Frames C–F</b>	
110V 50 Hz, 120V 60 Hz	<b>A</b>
220V 50 Hz, 240V 60 Hz	<b>B</b>
230V 50 Hz	<b>F</b>
24V 50/60 Hz	<b>T</b>
24–27 Vdc	<b>TD</b>
415V 50 Hz, 480V 60 Hz	<b>C</b>
600V 60 Hz	<b>D</b>
208V 60 Hz	<b>E</b>
190V 50 Hz, 220V 60 Hz	<b>G</b>
240V 50 Hz, 277V 60 Hz	<b>H</b>
380V 50 Hz, 440V 60 Hz	<b>L</b>
400V 50 Hz	<b>N</b>
380V 60 Hz	<b>P</b>
12V 50/60 Hz	<b>R</b>
42V 50 Hz, 48V 60 Hz	<b>W</b>
48V 50 Hz	<b>Y</b>
110–130 Vdc	<b>AD</b>
200–240 Vdc	<b>BD</b>
48–60 Vdc	<b>WD</b>

Coil Voltage	Suffix Code
<b>Frame G</b>	
100–120V 50/60 Hz	<b>A</b>
190–240V 50/60 Hz	<b>B</b>
24V 50/60 Hz	<b>T</b>
24–27 Vdc	<b>TD</b>
480–500V 50/60 Hz	<b>C</b>
380–440V 50/60 Hz	<b>L</b>
42–48V 50/60 Hz	<b>W</b>
110–130 Vdc	<b>AD</b>
200–240 Vdc	<b>BD</b>
48–60 Vdc	<b>WD</b>
<b>Frame H</b>	
100–120V 50/60 Hz	<b>A</b>
190–240V 50/60 Hz	<b>B</b>
480–500V 50/60 Hz	<b>C</b>
380–440V 50/60 Hz	<b>L</b>
24V 50/60Hz	<b>T</b>
42–48V 50/60Hz	<b>W</b>
110–130 Vdc	<b>AD</b>
200–240 Vdc	<b>BD</b>
24–27 Vdc	<b>TD</b>
48–60 Vdc	<b>WD</b>

Coil Voltage	Suffix Code
<b>Frames L–N</b>	
110–250 Vdc 40–60 Hz	<b>A</b>
250–500V 40–60 Hz	<b>C</b>
48–110 Vdc 40–60 Hz	<b>Y</b>
24–48 Vdc	<b>TD</b> <sup>②</sup>
<b>Frames L–M, S-Series</b>	
110–120V 50/60 Hz	<b>A</b>
220–240V 50/60 Hz	<b>B</b>
<b>Frames P–R</b>	
230–250 Vdc 50–60 Hz	<b>B</b>

## Notes

<sup>①</sup> See **Page V5-T1-111** for electrical life curves.

<sup>②</sup> Frames L–M only.

#### Bimetallic Overload Relay Suffix

Motor Full Load Amperes	Suffix Code	For Use with Contactor Ampere Range	Overload Relay Catalog Number
<b>Frame B</b>			
0.1–0.16	<b>P16</b>	7–15A	XTOBP16BC1
0.16–0.24	<b>P24</b>	7–15A	XTOBP24BC1
0.24–0.4	<b>P40</b>	7–15A	XTOBP40BC1
0.4–0.6	<b>P60</b>	7–15A	XTOBP60BC1
0.6–1	<b>001</b>	7–15A	XTOB001BC1
1–1.6	<b>1P6</b>	7–15A	XTOB1P6BC1
1.6–2.4	<b>2P4</b>	7–15A	XTOB2P4BC1
2.4–4	<b>004</b>	7–15A	XTOB004BC1
4–6	<b>006</b>	7–15A	XTOB006BC1
6–10	<b>010</b>	7–15A	XTOB010BC1
9–12	<b>012</b>	9–15A	XTOB012BC1
12–16	<b>016</b>	12–15A	XTOB016BC1
<b>Frame C</b>			
0.1–0.16	<b>P16</b>	18–32A	XTOBP16CC1
0.16–0.24	<b>P24</b>	18–32A	XTOBP24CC1
0.24–0.4	<b>P40</b>	18–32A	XTOBP40CC1
0.4–0.6	<b>P60</b>	18–32A	XTOBP60CC1
0.6–1	<b>001</b>	18–32A	XTOB001CC1
1–1.6	<b>1P6</b>	18–32A	XTOB1P6CC1
1.6–2.4	<b>2P4</b>	18–32A	XTOB2P4CC1
2.4–4	<b>004</b>	18–32A	XTOB004CC1
4–6	<b>006</b>	18–32A	XTOB006CC1
6–10	<b>010</b>	18–32A	XTOB010CC1
10–16	<b>016</b>	18–32A	XTOB016CC1
16–24	<b>024</b>	18–32A	XTOB024CC1
24–32	<b>032</b>	25–32A	XTOB032CC1

Motor Full Load Amperes	Suffix Code	For Use with Contactor Ampere Range	Overload Relay Catalog Number
<b>Frame D</b>			
6–10	<b>010</b>	40–72A	XTOB010DC1
10–16	<b>016</b>	40–72A	XTOB016DC1
16–24	<b>024</b>	40–72A	XTOB024DC1
24–40	<b>04</b>	40–72A	XTOB040DC1
40–57	<b>057</b>	50–72A	XTOB057DC1
50–65	<b>065</b>	65–72A	XTOB065DC1
65–75	<b>075</b>	65–72A	XTOB075DC1
<b>Frame F</b>			
25–35	<b>035</b>	80–95A	XTOB055GC1 ①
35–50	<b>050</b>	80–95A	XTOB050GC1 ①
50–70	<b>070</b>	80–95A	XTOB070GC1 ①
70–100	<b>100</b>	80–95A	XTOB100GC1 ①
<b>Frame G</b>			
25–35	<b>035</b>	115–170A	XTOB055GC1 ①
35–50	<b>050</b>	115–170A	XTOB050GC1 ①
50–70	<b>070</b>	115–170A	XTOB070GC1 ①
70–100	<b>100</b>	115–170A	XTOB100GC1 ①
95–125	<b>125</b>	115–170A	XTOB125GC1 ①
120–150	<b>150</b>	150–170A	XTOB150GC1 ①
145–175	<b>175</b>	150–170A	XTOB175GC1 ①

#### Electronic Overload Relay Suffix

##### XTOE Maximum Overload Rating

	Standard Type Suffix	Ground Fault Type Suffix
<b>Frame B</b>		
0.33–1.65A	<b>5E1P6</b>	<b>5G1P6</b>
1–5A	<b>5E005</b>	<b>5G005</b>
4–20A	<b>5E020</b>	<b>5G020</b>
<b>Frame C</b>		
0.33–1.65A	<b>5E1P6</b>	<b>5G1P6</b>
1–5A	<b>5E005</b>	<b>5G005</b>
4–20A	<b>5E020</b>	<b>5G020</b>
9–45A	<b>5E045</b>	<b>5G045</b>
<b>Frame D</b>		
9–45A	<b>5E045</b>	<b>5G045</b>
20–100A	<b>5E100</b>	<b>5G100</b>
<b>Frame F, G</b>		
20–100A	<b>5E100</b>	<b>5G100</b>
<b>Frame G</b>		
35–175A	<b>5E175</b>	<b>5G175</b>

##### Note

① Catalog number refers to direct mount overload relay. Add an **S** to the end of the catalog number for separate mount.

## Star-Delta (Wye-Delta) Starters

## Frame B—Maximum UL/CSA Ratings

Three-Phase hp Ratings				Max. Changeover Time (sec)	Component Description	Catalog Number ①
200V	230V	460V	575V			
3	3	2-1/2	10	<20	K1M main contactor	XTCE007B10_
					K5M delta contactor	XTCE007B01_
					K3M star contactor	XTCE007B01_
					Mechanical interlock	XTCEXMLB
					K1T timing relay	XTTR6A60S51B
					Overload relay	XTOB...BC1
					(3) auxiliary contacts	XTCEXFAC20
					Star-delta link kit	XTCEXSDLB
3	5	7-1/2	10	<20	K1M main contactor	XTCE009B10_
					K5M delta contactor	XTCE009B01_
					K3M star contactor	XTCE009B01_
					Mechanical interlock	XTCEXMLB
					K1T timing relay	XTTR6A60S51B
					Overload relay	XTOB...BC1
					(3) auxiliary contacts	XTCEXFAC20
					Star-delta link kit	XTCEXSDLB
5	5	10	15	<20	K1M main contactor	XTCE012B10_
					K5M delta contactor	XTCE012B01_
					K3M star contactor	XTCE012B01_
					Mechanical interlock	XTCEXMLB
					K1T timing relay	XTTR6A60S51B
					Overload relay	XTOB...BC1
					(3) auxiliary contacts	XTCEXFAC20
					Star-delta link kit	XTCEXSDLB

## Frame B—Maximum IEC Ratings

AC-3 I <sub>e</sub> (A)	Three-Phase Motors 50–60 Hz						Max. Changeover Time (sec)	Component Description	Catalog Number ①
	220/230V	380/400V	415V	500V	660/690V	1000V			
12	3	5.5	7	5.5	5.5	—	<20	K1M main contactor	XTCE007B10_
								K5M delta contactor	XTCE007B01_
								K3M star contactor	XTCE007B01_
								Mechanical interlock	XTCEXMLB
								K1T timing relay	XTTR6A60S51B
								Overload relay	XTOB...BC1
								(3) auxiliary contacts	XTCEXFAC20
								Star-delta link kit	XTCEXSDLB
16	4	7.5	8	7.5	7.5	—	<20	K1M main contactor	XTCE009B10_
								K5M delta contactor	XTCE009B01_
								K3M star contactor	XTCE009B01_
								Mechanical interlock	XTCEXMLB
								K1T timing relay	XTTR6A60S51B
								Overload relay	XTOB...BC1
								(3) auxiliary contacts	XTCEXFAC20
								Star-delta link kit	XTCEXSDLB
22	5.5	11	14.5	11	11	—	<20	K1M main contactor	XTCE012B10_
								K5M delta contactor	XTCE012B01_
								K3M star contactor	XTCE012B01_
								Mechanical interlock	XTCEXMLB
								K1T timing relay	XTTR6A60S51B
								Overload relay	XTOB...BC1
								(3) auxiliary contacts	XTCEXFAC20
								Star-delta link kit	XTCEXSDLB

## Note

① Underscore ( ) indicates magnet coil suffix required. See Page V5-T1-62.

#### Frame C—Maximum UL/CSA Ratings

Three-Phase hp Ratings				Max. Changeover Time (sec)	Component Description	Catalog Number ①
200V	230V	460V	575V			
7-1/2	7-1/2	15	20	<20	K1M main contactor	XTCE018C10_
					K5M delta contactor	XTCE018C01_
					K3M star contactor	XTCE018C01_
					Mechanical interlock	XTCEXMLC
					K1T timing relay	XTTR6A60S51B
					Overload relay	XTOB...CC1
					(3) auxiliary contacts	XTCEXFAC20
					Star-delta link kit	XTCEXSDLC
10	15	30	40		<20	K1M main contactor
				K5M delta contactor		XTCE025C01_
				K3M star contactor		XTCE025C01_
				Mechanical interlock		XTCEXMLC
				K1T timing relay		XTTR6A60S51B
				Overload relay		XTOB...CC1
				(3) auxiliary contacts		XTCEXFAC20
				Star-delta link kit		XTCEXSDLC
15	20	40	50	<20		K1M main contactor
					K5M delta contactor	XTCE032C01_
					K3M star contactor	XTCE032C01_
					Mechanical interlock	XTCEXMLC
					K1T timing relay	XTTR6A60S51B
					Overload relay	XTOB...CC1
					(3) auxiliary contacts	XTCEXFAC20
					Star-delta link kit	XTCEXSDLC

#### Frame C—Maximum IEC Ratings

AC-3 I <sub>e</sub> (A)	Three-Phase Motors 50–60 Hz						Max. Changeover Time (sec)	Component Description	Catalog Number ①
	220/230V	380/400V	415V	500V	660/690V	1000V			
30	7.5	15	19	18.5	18.5	—	<20	K1M main contactor	XTCE018C10_
								K5M delta contactor	XTCE018C01_
								K3M star contactor	XTCE018C01_
								Mechanical interlock	XTCEXMLC
								K1T timing relay	XTTR6A60S51B
								Overload relay	XTOB...CC1
								(3) auxiliary contacts	XTCEXFAC20
								Star-delta link kit	XTCEXSDLC
45	11	22	30	30	22	—		<20	K1M main contactor
							K5M delta contactor		XTCE025C01_
							K3M star contactor		XTCE025C01_
							Mechanical interlock		XTCEXMLC
							K1T timing relay		XTTR6A60S51B
							Overload relay		XTOB...CC1
							(3) auxiliary contacts		XTCEXFAC20
							Star-delta link kit		XTCEXSDLC
55	15	30	39	37	30	—	<20		K1M main contactor
								K5M delta contactor	XTCE032C01_
								K3M star contactor	XTCE032C01_
								Mechanical interlock	XTCEXMLC
								K1T timing relay	XTTR6A60S51B
								Overload relay	XTOB...CC1
								(3) auxiliary contacts	XTCEXFAC20
								Star-delta link kit	XTCEXSDLC

**Note**

① Underscore ( \_ ) indicates magnet coil suffix required. See Page V5-T1-62.



## Frame D—Maximum UL/CSA Ratings

Three-Phase hp Ratings				Max. Changeover Time (sec)	Component Description	Catalog Number ①
200V	230V	460V	575V			
20	25	50	60	<20	K1M main contactor	XTCE040D00_
					K5M delta contactor	XTCE040D00_
					K3M star contactor	XTCE040D00_
					Mechanical interlock	XTCEXMLD
					K1T timing relay	XTTR6A60S51B
					Overload relay	XTOB...DC1
					(2) auxiliary contacts (K1M, K3M)	XTCEXFBG11
					(1) auxiliary contact (K5M)	XTCEXFBG31
					Star-delta link kit	XTCEXSDL
25	30	60	75	<20	K1M main contactor	XTCE050D00_
					K5M delta contactor	XTCE050D00_
					K3M star contactor	XTCE040D00_
					Mechanical interlock	XTCEXMLD
					K1T timing relay	XTTR6A60S51B
					Overload relay	XTOB...DC1
					(2) auxiliary contacts (K1M, K3M)	XTCEXFBG11
					(1) auxiliary contact (K5M)	XTCEXFBG31
					Star-delta link kit	XTCEXSDL
40	50	100	125	<20	K1M main contactor	XTCE065D00_
					K5M delta contactor	XTCE065D00_
					K3M star contactor	XTCE040D00_
					Mechanical interlock	XTCEXMLD
					K1T timing relay	XTTR6A60S51B
					Overload relay	XTOB...DC1
					(2) auxiliary contacts (K1M, K3M)	XTCEXFBG11
					(1) auxiliary contact (K5M)	XTCEXFBG31
					Star-delta link kit	XTCEXSDL

## Frame D—Maximum IEC Ratings

AC-3 I <sub>e</sub> (A)	Three-Phase Motors 50–60 Hz						Max. Changeover Time (sec)	Component Description	Catalog Number ①
	220/230V	380/400V	415V	500V	660/690V	1000V			
70	18.5	37	37	45	37	—	<20	K1M main contactor	XTCE040D00_
								K5M delta contactor	XTCE040D00_
								K3M star contactor	XTCE040D00_
								Mechanical interlock	XTCEXMLD
								K1T timing relay	XTTR6A60S51B
								Overload relay	XTOB...DC1
								(2) auxiliary contacts (K1M, K3M)	XTCEXFBG11
								(1) auxiliary contact (K5M)	XTCEXFBG31
								Star-delta link kit	XTCEXSDL
90	22	45	45	55	45	—	<20	K1M main contactor	XTCE050D00_
								K5M delta contactor	XTCE050D00_
								K3M star contactor	XTCE040D00_
								Mechanical interlock	XTCEXMLD
								K1T timing relay	XTTR6A60S51B
								Overload relay	XTOB...DC1
								(2) auxiliary contacts (K1M, K3M)	XTCEXFBG11
								(1) auxiliary contact (K5M)	XTCEXFBG31
								Star-delta link kit	XTCEXSDL
115	30	55	55	75	55	—	<20	K1M main contactor	XTCE065D00_
								K5M delta contactor	XTCE065D00_
								K3M star contactor	XTCE040D00_
								Mechanical interlock	XTCEXMLD
								K1T timing relay	XTTR6A60S51B
								Overload relay	XTOB...DC1
								(2) auxiliary contacts (K1M, K3M)	XTCEXFBG11
								(1) auxiliary contact (K5M)	XTCEXFBG31
								Star-delta link kit	XTCEXSDL

**Note**

① Underscore ( ) indicates magnet coil suffix required. See Page V5-T1-62.

#### Frame F—Maximum UL/CSA Ratings

Three-Phase hp Ratings				Max. Changeover Time (sec)	Component Description	Catalog Number ①
200V	230V	460V	575V			
40	60	125	150	<20	K1M main contactor	XTCE080F00_
					K5M delta contactor	XTCE080F00_
					K3M star contactor	XTCE080F00_
					Mechanical interlock ②	XTCEXMLG
					K1T timing relay	XTTR6A60S51B
					Overload relay	XTOB...FC1
					(2) auxiliary contacts (K1M, K3M)	XTCEXFBG11
					(1) auxiliary contact (K5M)	XTCEXFBG31
					Star-delta link kit	XTCEXSDF
40	60	125	150	<20	K1M main contactor	XTCE095F00_
					K5M delta contactor	XTCE095F00_
					K3M star contactor	XTCE080F00_
					Mechanical interlock ②	XTCEXMLG
					K1T timing relay	XTTR6A60S51B
					Overload relay	XTOB...FC1
					(2) auxiliary contacts (K1M, K3M)	XTCEXFBG11
					(1) auxiliary contact (K5M)	XTCEXFBG31
					Star-delta link kit	XTCEXSDF

#### Frame F—Maximum IEC Ratings

AC-3 I <sub>e</sub> (A)	Three-Phase Motors 50–60 Hz						Max. Changeover Time (sec)	Component Description	Catalog Number ①
	220/230V	380/400V	415V	500V	660/690V	1000V			
140	37	75	75	90	90	—	<20	K1M main contactor	XTCE080F00_
								K5M delta contactor	XTCE080F00_
								K3M star contactor	XTCE080F00_
								Mechanical interlock ②	XTCEXMLG
								K1T timing relay	XTTR6A60S51B
								Overload relay	XTOB...FC1
								(2) auxiliary contacts (K1M, K3M)	XTCEXFBG11
								(1) auxiliary contact (K5M)	XTCEXFBG31
								Star-delta link kit	XTCEXSDF
165	45	90	110	110	132	—	<20	K1M main contactor	XTCE095F00_
								K5M delta contactor	XTCE095F00_
								K3M star contactor	XTCE080F00_
								Mechanical interlock ②	XTCEXMLG
								K1T timing relay	XTTR6A60S51B
								Overload relay	XTOB...FC1
								(2) auxiliary contacts (K1M, K3M)	XTCEXFBG11
								(1) auxiliary contact (K5M)	XTCEXFBG31
								Star-delta link kit	XTCEXSDF

#### Notes

- ① Underscore (\_) indicates magnet coil suffix required. See [Page V5-T1-62](#).
- ② If mechanical interlock of star contactor is required, it must be the same frame size of the delta contactor or use the same mechanical interlock, see [Page V5-T1-73](#) for mechanical interlocks. (Example: XTCE...L22\_ and XTCE...M22\_ both use mechanical interlock XTCEXMLM.)

## Frame G—Maximum UL/CSA Ratings

Three-Phase hp Ratings				Max. Changeover Time (sec)	Component Description	Catalog Number ①
200V	230V	460V	575V			
50	60	125	150	<20	K1M main contactor	XTCE115G00_
					K5M delta contactor	XTCE115G00_
					K3M star contactor	XTCE080F00_
					Mechanical interlock	XTCEXMLG
					K1T timing relay	XTTR6A60S51B
					Overload relay	XTOB...GC1
					(2) auxiliary contacts	XTCEXFBG11
					(1) auxiliary contact (K5M)	XTCEXFBG31
					Star-delta link kit	XTCEXSDLG
75	100	200	250	<20	K1M main contactor	XTCE150G00_
					K5M delta contactor	XTCE150G00_
					K3M star contactor	XTCE080F00_
					Mechanical interlock	XTCEXMLG
					K1T timing relay	XTTR6A60S51B
					Overload relay	XTOB...GC1
					(2) auxiliary contacts	XTCEXFBG11
					(1) auxiliary contact (K5M)	XTCEXFBG31
					Star-delta link kit	XTCEXSDLG

## Frame G—Maximum IEC Ratings

AC-3 I <sub>e</sub> (A)	Three-Phase Motors 50–60 Hz						Max. Changeover Time (sec)	Component Description	Catalog Number ①
	220/230V	380/400V	415V	500V	660/690V	1000V			
200	55	110	132	132	160	—	<20	K1M main contactor	XTCE115G00_
								K5M delta contactor	XTCE115G00_
								K3M star contactor	XTCE080F00_
								Mechanical interlock	XTCEXMLG
								K1T timing relay	XTTR6A60S51B
								Overload relay	XTOB...GC1
								(2) auxiliary contacts	XTCEXFBG11
								(1) auxiliary contact (K5M)	XTCEXFBG31
								Star-delta link kit	XTCEXSDLG
260	75	132	148	160	160	—	<20	K1M main contactor	XTCE150G00_
								K5M delta contactor	XTCE150G00_
								K3M star contactor	XTCE080F00_
								Mechanical interlock	XTCEXMLG
								K1T timing relay	XTTR6A60S51B
								Overload relay	XTOB...GC1
								(2) auxiliary contacts	XTCEXFBG11
								(1) auxiliary contact (K5M)	XTCEXFBG31
								Star-delta link kit	XTCEXSDLG

**Note**

① Underscore ( ) indicates magnet coil suffix required. See Page V5-T1-62.

#### Frame L—Maximum UL/CSA Ratings

Three-Phase hp Ratings				Max. Changeover Time (sec)	Component Description	Catalog Number ①
200V	230V	460V	575V			
125	150	300	400	<30	K1M main contactor	XTCS250L22_
					K5M delta contactor	XTCS250L22_
					K3M star contactor	XTCS250L22_
					Mechanical interlock	XTCEXMLM
					K1T timing relay	XTTR6A60S51B
					Overload relay	XTOB...LC1

#### Frame L—Maximum IEC Ratings

AC-3 I <sub>e</sub> (A)	Three-Phase Motors 50–60 Hz						Max. Changeover Time (sec)	Component Description	Catalog Number ①
	220/230V	380/400V	415V	500V	660/690V	1000V			
430	132	250	300	315	400	200	<30	K1M main contactor	XTCS250L22_
								K5M delta contactor	XTCS250L22_
								K3M star contactor	XTCS250L22_
								Mechanical interlock	XTCEXMLM
								K1T timing relay	XTTR6A60S51B
								Overload relay	XTOB...LC1

#### Frame M—Maximum UL/CSA Ratings

Three-Phase hp Ratings				Max. Changeover Time (sec)	Component Description	Catalog Number ①
200V	230V	460V	575V			
200	250	500	600	<20	K1M main contactor	XTCS400M22_
					K5M delta contactor	XTCS400M22_
					K3M star contactor	XTCS250L22_
					Mechanical interlock	XTCEXMLM
					K1T timing relay	XTTR6A60S51B
					Overload relay	XTOT...C3S
290	350	700	860	<30	K1M main contactor	XTCS500M22_
					K5M delta contactor	XTCS500M22_
					K3M star contactor	XTCS300M22_
					Mechanical interlock	XTCEXMLM
					K1T timing relay	XTTR6A60S51B
					Overload relay	XTOT...C3S

#### Frame M—Maximum IEC Ratings

AC-3 I <sub>e</sub> (A)	Three-Phase Motors 50–60 Hz						Max. Changeover Time (sec)	Component Description	Catalog Number ①
	220/230V	380/400V	415V	500V	660/690V	1000V			
685	200	355	390	450	560	220	<20	K1M main contactor	XTCS400M22_
								K5M delta contactor	XTCS400M22_
								K3M star contactor	XTCS250L22_
								Mechanical interlock	XTCSXMLM
								K1T timing relay	XTTR6A60S51B
								Overload relay	XTOT...C3S
860	250	450	500	560	600	220	<30	K1M main contactor	XTCS500M22_
								K5M delta contactor	XTCS500M22_
								K3M star contactor	XTCS300M22_
								Mechanical interlock	XTCEXMLM
								K1T timing relay	XTTR6A60S51B
								Overload relay	XTOT...C3S

#### Notes

- ① Underscore ( ) indicates magnet coil suffix required. See **Page V5-T1-62**.
- ② If mechanical interlock of star contactor is required, it must be the same frame size of the delta contactor or use the same mechanical interlock, see **Page V5-T1-73** for mechanical interlocks. (Example: XTCE...L22\_ and XTCE...M22\_ both use mechanical interlock XTCEXMLM.)

Frame N—Maximum UL/CSA Ratings are not applicable.

### Frame N—Maximum IEC Ratings

AC-3 I <sub>e</sub> (A)	Three-Phase Motors 50–60 Hz						Max. Changeover Time (sec)	Component Description	Catalog Number <sup>①</sup>
	220/230V	380/400V	415V	500V	660/690V	1000V			
1000	300	560	610	710	900	355	<30	K1M main contactor	XTCE580N22_
								K5M delta contactor	XTCE580N22_
								K3M star contactor	XTCE580N22_
								Mechanical interlock <sup>②</sup>	XTCEXMLN
								K1T timing relay	XTTR6A60S51B
								Overload relay	XTOT...C3S
1120	350	630	680	750	950	355	<30	K1M main contactor	XTCE650N22_
								K5M delta contactor	XTCE650N22_
								K3M star contactor	XTCE580N22_
								Mechanical interlock <sup>②</sup>	XTCEXMLN
								K1T timing relay	XTTR6A60S51B
								Overload relay	XTOT...C3S
1290	400	710	760	900	1200	1400	<30	K1M main contactor	XTCE750N22_
								K5M delta contactor	XTCE750N22_
								K3M star contactor	XTCE580N22_
								Mechanical interlock	XTCEXMLN
								K1T timing relay	XTTR6A60S51B
								Overload relay	XTOT...C3S
1400	450	800	850	950	1300	1400	<30	K1M main contactor	XTCE820N22_
								K5M delta contactor	XTCE820N22_
								K3M star contactor	XTCE580N22_
								Mechanical interlock	XTCEXMLN
								K1T timing relay	XTTR6A60S51
								Overload relay	XTOT...C3S
1700	560	1000	1050	1200	1700	1700	<20	K1M main contactor	XTCEC10N22_
								K5M delta contactor	XTCEC10N22_
								K3M star contactor	XTCE650N22_
								Mechanical interlock	XTCEXMLN
								K1T timing relay	XTTR6A60S51B
								Overload relay	XTOT...C3S

#### Notes

Main circuit: Depending on the coordination type required (that is, Type 1 or Type 2) it must be established whether the fuse protection and the input wiring for the main and delta contactors are to be common or separate.

Control circuit: If the combinations are used in the scope of the IEC/EN 60 204-1, VDE 0113 part 1, point 9.1.1 regarding the supply of control circuits is to be observed.

<sup>①</sup> Underscore ( \_ ) indicates magnet coil suffix required. See **Page V5-T1-62**.

<sup>②</sup> If mechanical interlock of star contactor is required, it must be the same frame size of the delta contactor or use the same mechanical interlock, see **Page V5-T1-73** for mechanical interlocks. (Example: XTCE...L22\_ and XTCE...M22\_ both use mechanical interlock XTCEXMLM.)

#### Spare Auxiliary Contacts

AC-3	K1M	K3M	K5M
12–55			
90–260		—	—
315–1700			

#### Magnet Coil Suffix

Coil Voltage	Suffix Code
<b>Frames A–B</b>	
110V 50 Hz, 120V 60 Hz	<b>A</b>
220V 50 Hz, 240V 60 Hz	<b>B</b>
230V 50 Hz	<b>F</b>
24V 50/60 Hz	<b>T</b>
24 Vdc	<b>TD</b>
415V 50 Hz, 480V 60 Hz	<b>C</b>
600V 60 Hz	<b>D</b>
208V 60 Hz	<b>E</b>
190V 50 Hz, 220V 60 Hz	<b>G</b>
240V 50 Hz, 277V 60 Hz	<b>H</b>
380V 50 Hz, 440V 60 Hz	<b>L</b>
400V 50 Hz	<b>N</b>
380V 60 Hz	<b>P</b>
12V 50/60 Hz	<b>R</b>
42V 50 Hz, 48V 60 Hz	<b>W</b>
48V 50 Hz	<b>Y</b>
120 Vdc	<b>AD</b>
220 Vdc	<b>BD</b>
12 Vdc	<b>RD</b>
48 Vdc	<b>WD</b>

Coil Voltage	Suffix Code
<b>Frames C–F</b>	
110V 50 Hz, 120V 60 Hz	<b>A</b>
220V 50 Hz, 240V 60 Hz	<b>B</b>
230V 50 Hz	<b>F</b>
24V 50/60 Hz	<b>T</b>
24–27 Vdc	<b>TD</b>
415V 50 Hz, 480V 60 Hz	<b>C</b>
600V 60 Hz	<b>D</b>
208V 60 Hz	<b>E</b>
190V 50 Hz, 220V 60 Hz	<b>G</b>
240V 50 Hz, 277V 60 Hz	<b>H</b>
380V 50 Hz, 440V 60 Hz	<b>L</b>
400V 50 Hz	<b>N</b>
380V 60 Hz	<b>P</b>
12V 50/60 Hz	<b>R</b>
42V 50 Hz, 48V 60 Hz	<b>W</b>
48V 50 Hz	<b>Y</b>
110–130 Vdc	<b>AD</b>
200–240 Vdc	<b>BD</b>
48–60 Vdc	<b>WD</b>

Coil Voltage	Suffix Code
<b>Frame G</b>	
100–120V 50/60 Hz	<b>A</b>
190–240V 50/60 Hz	<b>B</b>
24V 50/60 Hz	<b>T</b>
24–27 Vdc	<b>TD</b>
480–500V 50/60 Hz	<b>C</b>
380–440V 50/60 Hz	<b>L</b>
42–48V 50/60 Hz	<b>W</b>
110–130 Vdc	<b>AD</b>
200–240 Vdc	<b>BD</b>
48–60 Vdc	<b>WD</b>
<b>Frame H</b>	
100–120V 50/60 Hz	<b>A</b>
190–240V 50/60 Hz	<b>B</b>
480–500V 50/60 Hz	<b>C</b>
380–440V 50/60 Hz	<b>L</b>
24V 50/60Hz	<b>T</b>
42–48V 50/60Hz	<b>W</b>
110–130 Vdc	<b>AD</b>
200–240 Vdc	<b>BD</b>
24–27 Vdc	<b>TD</b>
48–60 Vdc	<b>WD</b>

Coil Voltage	Suffix Code
<b>Frames L–N</b>	
110–250 Vdc 40–60 Hz	<b>A</b>
250–500V 40–60 Hz	<b>C</b>
48–110 Vdc 40–60 Hz	<b>Y</b>
24–48 Vdc	<b>TD</b> <sup>①</sup>
<b>Frames L–M, S-Series</b>	
110–120V 50/60 Hz	<b>A</b>
220–240V 50/60 Hz	<b>B</b>
<b>Frames P–R</b>	
230–250 Vdc 50–60 Hz	<b>B</b>

#### Overload Relay Settings (A)

Setting	Starting
<b>A:</b> $I_N \times 0.58$ Motor protection in the star (wye) and delta configurations	≤15 sec
<b>B:</b> $I_N \times 1$ Only partial motor protection in star position	15–40 sec
<b>C:</b> $I_N \times 0.58$ Motor not protected in star (wye) position	>40 sec
Timing relay set to approximately 10 sec	

#### Note

① Frames L–M only.

XTCC0\_

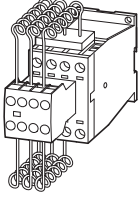

### XTCC Contactors for Three-Phase Capacitors

Three-Phase Capacitors, 50–60 Hz  
Open kVAR Ratings <sup>①</sup>

230V	400V	525V	690V	Contact Sequence	Catalog Number <sup>②</sup>
11	20	25	33.3		XTCC020C11_
15	25	33.3	40		XTCC025C11_
20	33.3	40	55		XTCC033D10_
25	50	65	85		XTCC050D10_

### Magnet Coil Suffix

Coil Voltage	Suffix Code
110V 50 Hz, 120V 60 Hz	<b>A</b>
220V 50 Hz, 240V 60 Hz	<b>B</b>
230V 50 Hz, 240V 60 Hz	<b>F</b>
400V 50 Hz, 440V 60 Hz	<b>N</b>
24V 50/60 Hz	<b>T</b>

#### Notes

Weld-resistant for capacitors with inrush current peaks up to  $180 \times I_N$ .

<sup>①</sup> With series resistors, without quick-discharge resistor.

<sup>②</sup> Underscore ( \_ ) indicates magnet coil suffix required.

**Engineering Notes for XTCC and XTCE Contactors for Power Factor Correction****Individual Compensation, Open Version**

Catalog Number	Switching Duty in kVAR			
	230V	400V, 420V, 440V	525V	690V
XTCE007B	1.5	3	3.5	5
XTCE009B	2	4	4.5	6
XTCE012B	2.5	4.5	5.5	7
XTCE015B	2.5	4.5	5.5	7
XTCE018C	6.5	12	14.5	19
XTCE025C	7	13.5	16	21
XTCE032C	7.5	14.5	17	22.5
XTCE040D	11	20.5	24.5	32
XTCE050D	11.5	22	26	34.5
XTCE065D	12.5	23.5	28	37
XTCE080F	16	30.5	36.5	48
XTCE095F	18	34	41	54
XTCE115G	24	46	54.5	72
XTCE150G	28	53	63.5	83.5
XTCE580N	175	300	400	300

**Group Compensation, with Reactor, Open Version**

Catalog Number	Switching Duty in kVAR			
	230V	400V, 420V, 440V	525V	690V
XTCE007B	4	7	7.5	12
XTCE009B	5	8	10	14
XTCE012B	5.5	1	12	16
XTCE015B	5.5	10	12	16
XTCE018C	7.5	16	20	28
XTCE025C	9	18	23	30
XTCE032C	10	20	24	32
XTCE040D	13	25	30	40
XTCE050D	16	30	36	48
XTCE065D	19	36	43	57
XTCE080F	30	58	68	90
XTCE095	34	6	7	10
XTCE115G	44	8	100	125
XTCE150	5	97	115	152
XTCE250L	110	190	260	340
XTCE400M	160	280	370	480
XTCE500M	220	390	500	680

**Group Compensation, without Reactor, Open Version**

Catalog Number	Switching Duty in kVAR			
	230V	400V, 420V, 440V	525V	690V
XTCC020C	11	20	25	33.3
XTCC025C	15	25	33.3	40
XTCC033D	20	33.3	40	55
XTCC050D	25	50	65	85
XTCE580N	145	250	333	250

















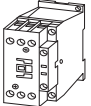



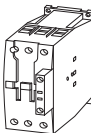

## Accessories

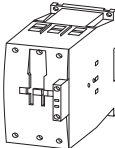
### Auxiliary Contacts

Front-mounted snap-on auxiliary contacts for **XT** contactors are available with screw or spring cage terminals in a variety of contact configurations.

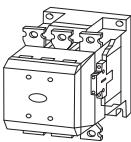
### Auxiliary Contacts Possible Combinations

Frame Size	Catalog Number	Contactor	Built-In Auxiliary	Front (Top) Mount		Side-Mount		Total Auxiliary Contacts Available
				Two-Pole	Four-Pole	Single-Pole	Two-Pole	
A	XTMC6A_ – XTMC9A_		1NO or 1NC	1	—	—	—	3
				—	1	—	—	5
						—	—	—
B	XTCE007B_ – XTCE015B_		1NO or 1NC	1	—	—	—	3
				—	1	—	—	5
				—	—	1	—	2
							—	—
C	XTCE018C_ – XTCE032C_		1NO or 1NC	1	—	—	—	3
				—	1	—	—	5
				—	—	—	1	3
						—		—
D	XTCE040D00_ – XTCE065D00_		—	1	—	—	2	6
				—	1	—	1	6
						—		—
F-G	XTCE080F00_ – XTCE150G00_		—	1	—	—	2	6
				—	1	—	2	8
				—	—	—	4	8
						—		—
L-R	XTCE185H22_ – XTCEC20R22_		2NO-2NC	—	—	—	2	8
				—	—	—		—

### Notes

Forced operation contact to IEC/EN 60947-5-1 Appendix L (positively driven), inside the auxiliary contact unit (not early close and late opening).

Auxiliary normally closed contact can be used as mirror contact to IEC/EN 60947-4-1 Appendix F (not late opening).

No auxiliary contacts can be fitted between two contactors.

#### 1

#### Auxiliary Contact Combinations

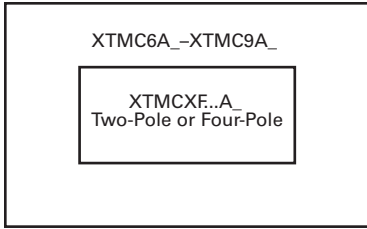

Frame A

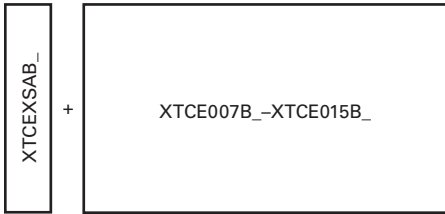

or

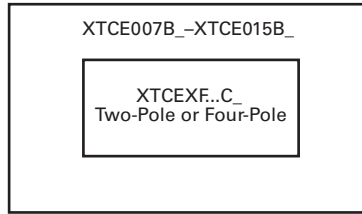

Frame B

*Not for use with mechanical interlock.*

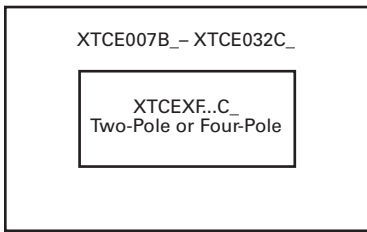

or

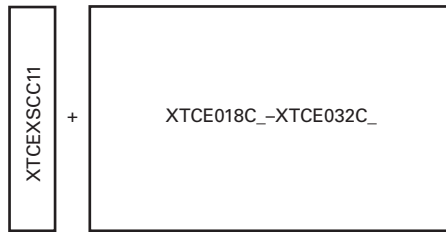

Frame C

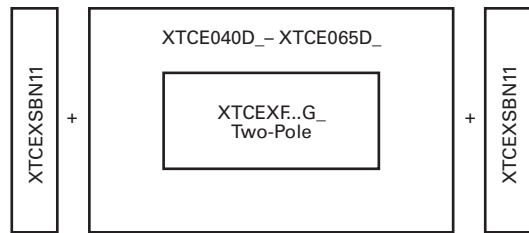

or

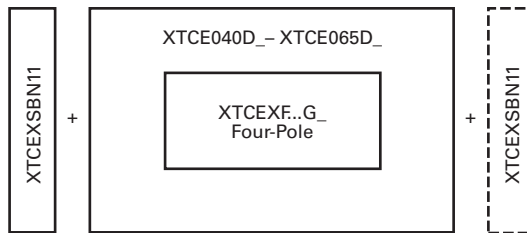

Frame D

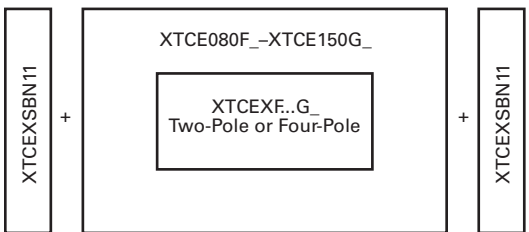

or

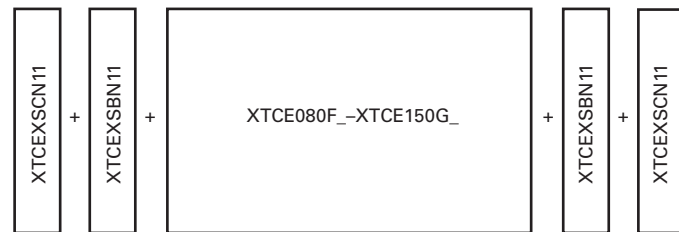

Frames F-G

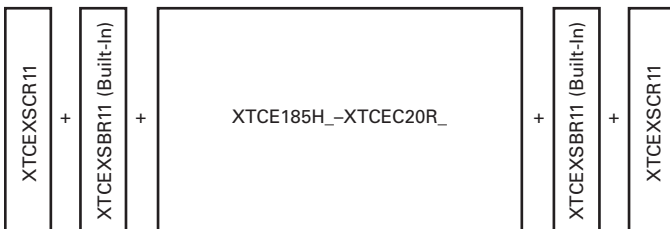

Frames L-R

## Auxiliary Contacts

XTCEXF\_

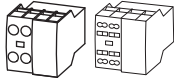

## Frames B–C, Front (Top) Mount—Two-Pole

Conventional Thermal Current,  
Open at 60°C  
 $I_{th} = I_e$ , AC-1 in Amps

	Contact Configuration	Circuit Symbol	Pkg. Qty. ①	Screw Terminal Catalog Number
16	2NO		5	XTCEXFAC20
16	1NO-1NC		5	XTCEXFAC11 ④
16	2NC		5	XTCEXFAC02
16	1NO <sub>E</sub> -1NC <sub>L</sub>		5	XTCEXFALC11 ②
16	1NO-1NC		5	XTCEXFDC11 ③
16	2NC		5	XTCEXFCC02 ③

XTCEXF\_

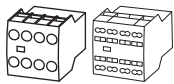

## Frames B–C, Front (Top) Mount—Four-Pole

Conventional Thermal Current,  
Open at 60°C  
 $I_{th} = I_e$ , AC-1 in Amps

	Contact Configuration	Circuit Symbol	Pkg. Qty. ①	Screw Terminal Catalog Number
16	4NO		5	XTCEXFAC40 ④
16	3NO-1NC		5	XTCEXFAC31 ④
16	2NO-2NC		5	XTCEXFAC22 ④
16	1NO-3NC		5	XTCEXFAC13
16	4NC		5	XTCEXFAC04
16	1NO <sub>E</sub> -1NC <sub>L</sub>		5	XTCEXFCLC22 ②
16	2NO-2NC		5	XTCEXFCC22 ③

## Notes

- ① Orders must be placed in multiples of package quantity listed.
- ② 1 early-make contact (1NO<sub>E</sub>), 1 late-break contact (1NC<sub>L</sub>).
- ③ To avoid duplicate terminal numbers in contact sequence, these auxiliary contacts should only be used with contactors having a built-in 1NO contact (XTCE...B10\_, XTCE...C10\_).
- ④ Catalog number is shown with screw type terminal. For spring cage, add a "C" before the last 2 digits. For example, to order a spring cage version of the XTCEXFAC22, change the catalog number to XTCEXFACC22.

1

#### XTCEXFATC\_



#### Frames B–C, Front (Top) Mount—Tall Version Two-Pole ①

Conventional Thermal Current, Open at 60°C $I_{th} = I_e$ , AC-1 in Amps	Contact Configuration	Circuit Symbol	Pkg. Qty. ②	Screw Terminal Catalog Number
16	2NO		5	XTCEXFATC20
16	1NO-1NC		5	XTCEXFATC11
16	2NC		5	XTCEXFATC02

#### XTCEXFATC22



#### Frames B–C, Front (Top) Mount—Tall Version Four-Pole ①

Conventional Thermal Current, Open at 60°C $I_{th} = I_e$ , AC-1 in Amps	Contact Configuration	Circuit Symbol	Pkg. Qty. ②	Screw Terminal Catalog Number
16	2NO-2NC		5	XTCEXFATC22

#### XTCEXSAB\_

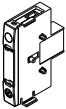

#### Frame B, Side-Mount—Single-Pole

Conventional Thermal Current, Open at 60°C $I_{th} = I_e$ , AC-1 in Amps	Contact Configuration	Circuit Symbol	Pkg. Qty. ②	Screw Terminal Catalog Number
16	1NO		1	XTCEXSAB10 ③
16	1NC		1	XTCEXSAB01 ③

#### XTCEXSACC11

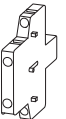

#### Frame C, Side-Mount—Two-Pole

Conventional Thermal Current, Open at 60°C $I_{th} = I_e$ , AC-1 in Amps	Contact Configuration	Circuit Symbol	Pkg. Qty. ②	Screw Terminal Catalog Number
10	1NO-1NC		1	XTCEXSACC11 ③

#### Notes

Interlocked opposing contacts, to IEC/EN 60947-5-1 Annex L (positively driven), within the auxiliary contact modules (not NO [early make] and NC [late break] contacts) and for the built-in auxiliary contacts of the XTCE007B\_–XTCE032C\_.

Auxiliary break contact can be used as mirror contact to IEC/EN 60947-4-1 Annex F (not NC [late break] contact).

No auxiliary contacts can be fitted between two contactors.

① Front (top) mount tall version is for use with Frame B electrical wire bridges and link kits (see **Page V5-T1-74**) and toolless plug combination connection kits: XTCEXRLB, XTCEXSDB, XTPAXTPCB, XTPAXTPCRB, XTPAX.

② Orders must be placed in multiples of package quantity listed.

③ Can be mounted to the left side of contactor only. Cannot be used in combination with front (top) mount auxiliary contacts or mechanical interlocks.

XTCEXF\_



## Frames D–G—Two-Pole

Conventional Thermal Current,  
Open at 60°C  
 $I_{th} = I_e$ , AC-1 in Amps

	Contact Configuration	Circuit Symbol	Pkg. Qty. ①	Screw Terminal Catalog Number
16	2NO		5	XTCEXFBG20
16	1NO-1NC		5	XTCEXFAG11
16	1NO-1NC		5	XTCEXFBG11
16	2NC		5	XTCEXFBG02

XTCEXF\_



## Frames D–G—Four-Pole

Conventional Thermal Current,  
Open at 60°C  
 $I_{th} = I_e$ , AC-1 in Amps

	Contact Configuration	Circuit Symbol	Pkg. Qty. ①	Screw Terminal Catalog Number
16	4NO-0NC		5	XTCEXFBG40
16	3NO-1NC		5	XTCEXFBG31
16	2NO-2NC		5	XTCEXFBG22
16	2NO-2NC		5	XTCEXFAG_22 ②
16	1NO-3NC		5	XTCEXFBG13
16	0NO-4NC		5	XTCEXFBG04
16	1NO <sub>E</sub> -1NC <sub>L</sub>		5	XTCEXFBG22 ③

**Notes**

Interlocked opposing contacts, to IEC/EN 60947-5-1 Annex L (positively driven), within the auxiliary contact modules (not NO (early make) and NC (late break) contacts) and for the built-in auxiliary contacts of the XTCE007B\_–XTCE032C\_.

Auxiliary break contact can be used as mirror contact to IEC/EN 60947-4-1 Annex F (not NC (late break) contact).

No auxiliary contacts can be fitted between two contactors.

① Orders must be placed in multiples of package quantity listed.

② A “\_” denotes catalog numbers are incomplete. To complete the catalog number for ordering a spring cage terminal, insert a **C** in the “\_” position or remove “\_” for screw type terminal.

③ One early-make contact (1NO<sub>E</sub>), one late-break contact (1NC<sub>L</sub>).

1

XTCEXS\_

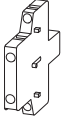

#### Frames D–H, Side Mount (Snap-On) – Two-Pole

Conventional Free Air Thermal Current, $I_{th} = I_e$ , AC-1 in Amps	Contact Configuration	Circuit Symbol	Pkg. Qty. ①	Screw Terminal Catalog Number
10	1NO–1NC		1	XTCEXSBN11
10	1NO <sub>E</sub> –1NC <sub>L</sub>		1	XTCEXSBLN11 ②
10	1NO–1NC		1	XTCEXSCN11 ③

XTCEXS\_

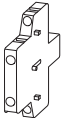

#### Frames L–R, Side Mount (Screw Mount) – Two-Pole

Conventional Free Air Thermal Current, $I_{th} = I_e$ , AC-1 in Amps	Contact Configuration	Circuit Symbol	Pkg. Qty. ①	Screw Terminal Catalog Number
10	1NO–1NC		1	XTCEXSBR11 ④
10	1NO <sub>E</sub> –1NC <sub>L</sub>		1	XTCEXSBLR11
10	1NO–1NC		1	XTCEXS CR11

#### Notes

- ① Orders must be placed in multiples of package quantity listed.
- ② 1 early-make contact (1NO<sub>E</sub>), 1 late-break contact (1NC<sub>L</sub>).
- ③ To avoid duplicate terminal numbers in contact sequence, the XTCEXSCN11 should be used with Frame D when a top mount auxiliary is also installed.
- ④ For replacement only. XTCEXSBR11 and XTCEXSBLR11 cannot be added onto side mount auxiliaries that come with the Frames L–R contactors as standard. To add auxiliaries onto the included side auxiliaries on Frames L–R contactors, use XTCEXS CR11.

**Suppressors**

The switching of contactor coils can generate voltage transients that may cause arching on switch contacts and/or damage electronics on the control line. Either an RC or varistor suppressor is recommended in these types of applications. All **XT** DC contactor coils have built-in suppression.

Varistor suppressors clamp the voltage transient above the maximum coil voltage and are recommended when the level of the transient is known to not exceed the coil voltage. RC suppressors slow and reduce the level of the voltage transient but do not clamp them at a specific level. The slowing of the transient can reduce electrical interference. These are recommended in applications where operating rates are high.

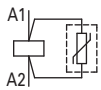
**XTCEXVS\_****Contact Sequence****Varistor Suppressor** ①②

Voltage	For Use with...	Pkg. Qty. ③	Catalog Number
24–48	XTCE007B–	10	<b>XTCEXVSBW</b>
48–130	XTCE015B, XTCF020B	10	<b>XTCEXVSB A</b>
130–240		10	<b>XTCEXVSB B</b>
240–500		10	<b>XTCEXVSB C</b>
24–48	XTCE018C–	10	<b>XTCEXVSCW</b>
48–130	XTCE032C	10	<b>XTCEXVSC A</b>
130–240		10	<b>XTCEXVSC B</b>
240–500		10	<b>XTCEXVSC C</b>
24–48	XTCE040D–	10	<b>XTCEXVSFW</b>
48–130	XTCE095F	10	<b>XTCEXVSFA</b>
130–240		10	<b>XTCEXVSFB</b>
240–500		10	<b>XTCEXVSFC</b>

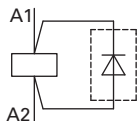
**XTCEXDSB****Contact Sequence****Free-Wheel Diode Suppressor** ④

Voltage DC	For Use with...	Pkg. Qty. ③	Catalog Number
12–250	XTCE007B– XTCE015B, XTCF020B	10	<b>XTCEXDSB</b>

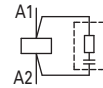
**XTCEXRS\_****Contact Sequence****RC Suppressor** ①②

Voltage	For Use with...	Pkg. Qty. ③	Catalog Number
24–48	XTCE007B–	10	<b>XTCEXRSBW</b>
48–130	XTCE015B, XTCF020B	10	<b>XTCEXRSBA</b>
110–240		10	<b>XTCEXRSBB</b>
240–500		10	<b>XTCEXRSBC</b>
24–48	XTCE018C–	10	<b>XTCEXRSBW</b>
110–130	XTCE032C	10	<b>XTCEXRSBA</b>
130–240		10	<b>XTCEXRSBB</b>
240–500		10	<b>XTCEXRSBC</b>
24–48	XTCE040D–	10	<b>XTCEXRSFW</b>
110–130	XTCE095F	10	<b>XTCEXRSFA</b>
130–240		10	<b>XTCEXRSFB</b>
240–500		10	<b>XTCEXRSFC</b>

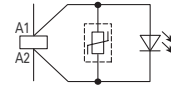
**XTCEXVSL\_****Contact Sequence****Varistor Suppressor with Integrated LED** ①②

Voltage AC	For Use with...	Pkg. Qty. ③	Catalog Number
24–48	XTCE007B–	10	<b>XTCEXVSLBW</b>
130–240	XTCE015B	10	<b>XTCEXVSLBB</b>
24–48	XTCE018C–	10	<b>XTCEXVSLCW</b>
130–240	XTCE032C	10	<b>XTCEXVSLCB</b>
24–48	XTCE040D–	10	<b>XTCEXVSLFW</b>
130–240	XTCE095F	10	<b>XTCEXVSLFB</b>

**Notes**

- ① Note dropout delay.
- ② For AC operated contactors, 50–60 Hz. DC operated contactors and XTCE115G\_ to XTCE170G\_ have a built-in suppressor circuit.
- ③ Orders must be placed in multiples of package quantity listed.
- ④ In addition to the built-in suppressor circuit for DC actuated contactors. Prevents negative breaking voltage when contactors are used in combination with a safety PLC.

### Electronic Timer Modules

#### Frames B–C Contactors (7–32A) <sup>①</sup>

XTCEXTE\_



Voltage	Contact Sequence	Timing Range	For Use with...	Pkg. Qty. <sup>②</sup>	Catalog Number	
<b>On-Delay</b>						
24 Vac/Vdc	A1	57 65	0.05s–1s	XTCE...B_	1	XTCEXTEEC11T
100–130 Vac	A2	58 66	0.5s–10s	XTCE...C_	1	XTCEXTEEC11A
200–240 Vac			5s–100s		1	XTCEXTEEC11B
<b>Off-Delay</b>						
24 Vac/Vdc	A1	57 65	0.05s–1s	XTCE...B_	1	XTCEXTED1C11T
100–130 Vac	A2	58 66		XTCE...C_	1	XTCEXTED1C11A
200–230 Vac					1	XTCEXTED1C11B
24 Vac/Vdc	A1	57 65	0.5s–10s	XTCE...B_	1	XTCEXTED10C11T
100–130 Vac	A2	58 66		XTCE...C_	1	XTCEXTED10C11A
200–240 Vac					1	XTCEXTED10C11B
24 Vac/Vdc	A1	57 65	5s–100s	XTCE...B_	1	XTCEXTED100C11T
100–130 Vac	A2	58 66		XTCE...C_	1	XTCEXTED100C11A
200–240 Vac					1	XTCEXTED100C11B
<b>Star-Delta</b>						
24 Vac/Vdc	A1	57 67	1s–30s	XTCE...B_	1	XTCEXTEYC20T
100–130 Vac	A2	58 68		XTCE...C_	1	XTCEXTEYC20A
200–240 Vac					1	XTCEXTEYC20B
<b>Sealable Shroud</b>						
—	Transparent sealable shroud used to protect electronic timer modules from unwanted access		XTCEXTEE, XTCEXTED, XTCEXTEY	1	XTCEXTESHRD	

XTCEXTESHRD





#### Notes

- ① Front (top) mounted timer modules for use with XTCE...B and XTCE...C contactors. Cannot be combined with top-mount auxiliary contacts, XTCEXF...C\_.
- ② Orders must be placed in multiples of package quantity listed.



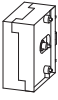
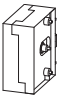

## Additional Accessories

Mechanical Interlock <sup>①</sup>

	For Use with...	Pkg. Qty. <sup>②</sup>	Catalog Number
	XTCE007B–XTCE015B, XTCF020B	5	<b>XTCEXMLB</b>
	XTCE018C–XTCE032C, XTCF032C–XTCF045C	1	<b>XTCEXMLC</b>
	XTCE040D–XTCE072D, XTCF063D–XTCF080D	1	<b>XTCEXMLD</b>
	XTCE080F–XTCE170G, XTCF125G–XTCF200G	1	<b>XTCEXMLG</b> <sup>③</sup>
	XTCE185H–XTCE570M	1	<b>XTCEXMLM</b>
	XTCE580N–XTCEC10N	1	<b>XTCEXMLN</b> <sup>③</sup>

## Reversing Link Kits

	For Use with...	Pkg. Qty. <sup>②</sup>	Catalog Number
	XTCE007B–XTCE015B	1	<b>XTCEXRLB</b> <sup>④</sup>
	XTCE018C–XTCE032C	1	<b>XTCEXRLC</b>
	XTCE040D–XTCE065D	1	<b>XTCEXRLD</b>
	XTCE080F–XTCE150G	1	<b>XTCEXRLG</b>

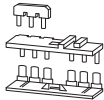

Main current wiring for reversing combinations. Includes paralleling bridge and reversing bridge. Does not include mechanical interlock, see table on this page.

## Star-Delta (Wye-Delta) Link Kits

	For Use with...	Pkg. Qty. <sup>②</sup>	Catalog Number
	XTCE007B–XTCE015B	1	<b>XTCEXSDLB</b> <sup>③</sup>
	XTCE018C–XTCE032C	1	<b>XTCEXSDLC</b>
	XTCE040D–XTCE065D	1	<b>XTCEXSDLD</b>
	XTCE080F–XTCE095F	1	<b>XTCEXSDLF</b>
	XTCE115G–XTCE150G	1	<b>XTCEXSDLG</b>



Main current wiring for star-delta (wye-delta) combinations. Includes paralleling bridge, reversing bridge and star-delta bridge. Does not include mechanical interlock, see table on this page.

## Paralleling Bridge

	For Use with...	Pkg. Qty. <sup>②</sup>	Catalog Number
	XTCE007B–XTCE015B	20	<b>XTCEXPBB</b>
	XTCE018C–XTCE032C	20	<b>XTCEXPBC</b>

Component part of reversing link kit (XTCEXRL\_). Parallels the phases on the line-side of two contactors.

## Reversing Bridge

	For Use with...	Pkg. Qty. <sup>②</sup>	Catalog Number
	XTCE007B–XTCE015B	20	<b>XTCEXRBB</b>
	XTCE018C–XTCE032C	20	<b>XTCEXRBC</b>
	XTCE040D–XTCE065D	10	<b>XTCEXRBD</b>

Component part of reversing link kit (XTCEXRL\_). Reverses the phases on the load-side of two contactors.

## Notes

- ① For two contactors with AC or DC operated magnet system which are horizontally or vertically mounted. For Frames B–G, mechanical lifespan is  $2.5 \times 10^6$  operations and the distance between contactors is 0 mm. For Frames L–N, mechanical lifespan is  $5 \times 10^6$  operations and no auxiliary contact can be mounted between the mechanical interlock and the contactor—the distance between contactors is 15 mm.
- ② Orders must be placed in multiples of package quantity listed.
- ③ XTCEXMLG and XTCEXMLN consist of an interlock element and mounting plate.
- ④ Also includes interlocking bridge (XTCEXLB). The following control cables are integrated for electrical interlock: K1M: A1–K2M: 21; K1M: 21–K2M: A1; K1M: A2–K2M: A2.

#### Electrical Interlocking Bridge

For Use with...	Pkg. Qty. ①	Catalog Number
XTCE007B–XTCE015B	20	<b>XTCEXLBB</b>

#### Star-Delta (Wye-Delta) Bridge

##### XTCEXSDB



For Use with...	Pkg. Qty. ①	Catalog Number
XTCE007B–XTCE015B	20	<b>XTCEXSDBB</b> ②
XTCE080F–XTCE170G	1	<b>XTCEXSDBG</b>
XTCE185L–XTCE400M	1	<b>XTCEXSDB400</b>
XTCE500M	1	<b>XTCEXSDB500</b>



Component part of star-delta link kit (XTCEXSDL\_). Commons the three phases on the line side of shorting contactor.

#### Connector

##### XTCEXCNC



For Use with...	Pkg. Qty. ①	Catalog Number
XTCE007B–XTCE032C	50	<b>XTCEXCNC</b>

##### XTCEXCNG



For Use with...	Pkg. Qty. ①	Catalog Number
XTCE040D–XTCE170G	10	<b>XTCEXCNG</b>

#### Parallel Link ④⑤⑥

##### XTCEXPLKB



For Use with...	Pkg. Qty. ①	Catalog Number
XTCE007B–XTCE015B	5	<b>XTCEXPLKB</b>

##### XTCEXPLK\_



For Use with...	Pkg. Qty. ①	Catalog Number
XTCE018C–XTCE032C	5	<b>XTCEXPLKC</b>
XTCE040D–XTCE072D	1	<b>XTCEXPLKD</b>
XTCE080F–XTCE170G	1	<b>XTCEXPLKG</b>

##### XTCEXPLKL185

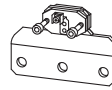

For Use with...	Pkg. Qty. ①	Catalog Number
XTCE185L	1	<b>XTCEXPLKL185</b>

For using one contactor per phase. Each package comes with two links for line: load.

#### Terminal Lug Assembly

##### XTCEXTLA400



For Use with...	Pkg. Qty. ①	Catalog Number
XTCE185–XTCE225H	1	<b>XTCEXTLA225A</b>
XTCS250L–XTCS400M, XTCE250L_–XTCE400M_	2	<b>XTCEXTLA400</b>

For connection of: round conductor, flexible and stranded, flat strip conductor, with control circuit terminal. See **Page V5-T1-97** for terminal capacities.

#### Contactor Labels

##### XGKE-GE



For Use with...	Pkg. Qty. ①	Catalog Number
XTC...	25	<b>XGKE-GE</b> ②

#### Notes

- ① Orders must be placed in multiples of package quantity listed.
- ② Frame B is toolless connection type.
- ③ For mechanically arranging contactors in combinations. Distance between contactors is 0 mm.
- ④ Fourth pole can be broken off: four-pole: I<sub>th</sub> = 60A; three-pole: I<sub>th</sub> = 50A.
- ⑤ AC-1 current carrying capacity of the contactor increases by a factor of 2.5. For XTCEXPLKL185, one shroud is included for protection against accidental contact.
- ⑥ Protected against accidental contact in accordance with IEC 536.
- ⑦ Quantity 1 equals one sheet. One sheet contains 240 labels.

## CI-K Basic Enclosures

CI-K Basic Enclosures <sup>①②</sup>

## Dimensions in Inches (mm)

Width	Height	External Depth	Internal Depth	Internal Mounting Type	Pkg. Qty.	Catalog Number
3.94 (100.0)	6.30 (160.0)	3.94 (100.0)	2.87 (73.0)	With mounting rail	1	<b>CI-K2X-100-TS-NA</b> <sup>③</sup>
			3.11 (79.0)	With mounting plate		<b>CI-K2X-100-M-NA</b> <sup>③</sup>
			5.71 (145.0)	With mounting rail		<b>CI-K2X-145-TS-NA</b> <sup>③</sup>
			4.88 (124.0)	With mounting plate		<b>CI-K2X-145-M-NA</b> <sup>③</sup>
4.72 (120.0)	7.87 (200.0)	4.92 (125.0)	3.66 (93.0)	With mounting rail	1	<b>CI-K3X-125-TS-NA</b> <sup>④</sup>
			3.86 (98.0)	With mounting plate		<b>CI-K3X-125-M-NA</b> <sup>④</sup>
			6.30 (160.0)	With mounting rail		<b>CI-K3X-160-TS-NA</b> <sup>④</sup>
			5.24 (133.0)	With mounting plate		<b>CI-K3X-160-M-NA</b> <sup>④</sup>
6.30 (160.0)	9.45 (240.0)	6.30 (160.0)	5.04 (128.0)	With mounting rail	1	<b>CI-K4X-160-TS-NA</b> <sup>④</sup>
			5.24 (133.0)	With mounting plate		<b>CI-K4X-160-M-NA</b> <sup>④</sup>
7.87 (200.0)	11.02 (280.0)	6.30 (160.0)	5.04 (128.0)	With mounting rail	1	<b>CI-K5X-160-TS-NA</b> <sup>④</sup>
			5.24 (133.0)	With mounting plate		<b>CI-K5X-160-M-NA</b> <sup>④</sup>

## XTCEXCN\_

## Terminal Lug Kit—Set of Three Lugs



For Use with...	Description	Pkg. Qty. <sup>⑤</sup>	Catalog Number
XTCE500M, XTCE570M	#4-500 kcmil two-phase Cu/Al 500A	1	<b>XTCEXTL500</b>

## XTCEXTFB6\_

Terminal Flat Bar <sup>⑥</sup>

For Use with...	Pkg. Qty. <sup>⑤</sup>	Catalog Number
XTCE500M–XTCE570M	1	<b>XTCEXTFB650</b>
XTCE750N–XTCE820N	1	<b>XTCEXTFB820</b>

For connection of a flat strip conductor. Comes with control circuit terminal (consisting of three flat strip conductor terminals).

## XTCEXTS\_

## Terminal Shroud



For Use with...	Pkg. Qty. <sup>⑤</sup>	Catalog Number
XTCE185H–XTCE225H	1	<b>XTCEXTS225</b>
XTCE250L–XTCE400M	1	<b>XTCEXTS400</b>
XTCE500M–XTCE570M	1	<b>XTCEXTS500</b>
XTCE580N–XTCE650N	1	<b>XTCEXTS650</b>
XTCE750N–XTCEC10N	1	<b>XTCEXTS820</b>

Protection against direct contact with connection lugs when touched vertically from the front.

## Notes

- ① Enclosure base RAL 9005, black/enclosure top only RAL 7035, light gray.
- ② Degree of protection—IEC: IP65; UL/CSA: Type 1, 3R, 4X, 12, 13—indoor and outdoor use.
- ③ CI-K2X\_: 4 x 1/2 inch knockouts.
- ④ CI-K3X\_, CI-K4X\_, CI-K5X\_: Smooth overall with sharp corners.
- ⑤ Orders must be placed in multiples of package quantity listed.
- ⑥ Not UL listed.

## Renewal Parts

## XTCERENC\_



## Replacement Coil—Frame C

Voltage	Coil Suffix	Catalog Number
110/50 120/60	A	XTCERENCOILCA
110–130 Vdc	AD	XTCERENCOILCAD
220/50 240/60	B	XTCERENCOILCB
200–240 Vdc	BD	XTCERENCOILCBD
415/50 480/60	C	XTCERENCOILCC
600/60	D	XTCERENCOILCD
208/60	E	XTCERENCOILCE
230/50	F	XTCERENCOILCF
190/50 220/60	G	XTCERENCOILCG
240/50 277/60	H	XTCERENCOILCH
380/50 440/60	L	XTCERENCOILCL
400/50	N	XTCERENCOILCN
380/60	P	XTCERENCOILCP
12/50 12/60	R	XTCERENCOILCR
12–14 Vdc	RD	XTCERENCOILCRD
24/50 24/60	T	XTCERENCOILCT
24–27 Vdc	TD	XTCERENCOILCTD
42/50 48/60	W	XTCERENCOILCW
48–60 Vdc	WD	XTCERENCOILCWD
48/50	Y	XTCERENCOILCY

## Replacement Coil—Frame D

Voltage	Coil Suffix	Catalog Number
110/50 120/60	A	XTCERENCOILDA
110–130 Vdc	AD	XTCERENCOILDAD
220/50 240/60	B	XTCERENCOILDB
200–240 Vdc	BD	XTCERENCOILDBD
415/50 480/60	C	XTCERENCOILDC
600/60	D	XTCERENCOILDD
208/60	E	XTCERENCOILDE
230/50	F	XTCERENCOILDF
190/50 220/60	G	XTCERENCOILDG
240/50 277/60	H	XTCERENCOILDH
380/50 440/60	L	XTCERENCOILDL
400/50	N	XTCERENCOILDN
380/60	P	XTCERENCOILD P
12/50 12/60	R	XTCERENCOILDR
12–14 Vdc	RD	XTCERENCOILDRD
24/50 24/60	T	XTCERENCOILDT
24–27 Vdc	TD	XTCERENCOILDTD
42/50 48/60	W	XTCERENCOILDW
48–60 Vdc	WD	XTCERENCOILDWD
48/50	Y	XTCERENCOILDY

## Replacement Coil—Frame F ①

Voltage	Coil Suffix	Catalog Number
110/50 120/60	A	XTCERENCOILFA
110–130 Vdc	AD	XTCERENCOILFAD
220/50 240/60	B	XTCERENCOILFB
200–240 Vdc	BD	XTCERENCOILFBD
415/50 480/60	C	XTCERENCOILFC
600/60	D	XTCERENCOILFD
208/60	E	XTCERENCOILFE
230/50	F	XTCERENCOILFF
190/50 220/60	G	XTCERENCOILFG
240/50 277/60	H	XTCERENCOILFH
380/50 440/60	L	XTCERENCOILFL
400/50	N	XTCERENCOILFN
380/60	P	XTCERENCOILFP
12/50 12/60	R	XTCERENCOILFR
24/50 24/60	T	XTCERENCOILFT
24–27 Vdc	TD	XTCERENCOILFTD
42/50 48/60	W	XTCERENCOILFW
48–60 Vdc	WD	XTCERENCOILFWD
48/50	Y	XTCERENCOILFY

## Replacement Coil—Frame G ②

Voltage	Coil Suffix	Catalog Number
100–120V 50/60	A	XTCERENCOILGA
110–130 Vdc	AD	XTCERENCOILGAD
190–240V 50/60	B	XTCERENCOILGB
200–240 Vdc	BD	XTCERENCOILGBD
480–500V 50/60	C	XTCERENCOILGC
380–440V 50/60	L	XTCERENCOILGL
4/50 24/60	T	XTCERENCOILGT
24–27 Vdc	TD	XTCERENCOILGTD
42–48V 50/60	W	XTCERENCOILGW
48–60 Vdc	WD	XTCERENCOILGWD

**Notes**

- ① Frame F replacement coils can only be used with contactors having the following date codes: DC coils, 2706 or later; AC coils, 4706 or later.
- ② Frame G replacement coils can only be used with contactors having date codes of 2706 or later.

**Replacement Coil—Frame H**

Voltage	Coil Suffix	Catalog Number
100–120V 50/60 Hz	<b>A</b>	<b>XTCERENCOILHA</b>
190–240V 50/60 Hz	<b>B</b>	<b>XTCERENCOILHB</b>
480–500V 50/60 Hz	<b>C</b>	<b>XTCERENCOILHC</b>
380–440V 50/60 Hz	<b>L</b>	<b>XTCERENCOILHL</b>
24V 50/60Hz	<b>T</b>	<b>XTCERENCOILHT</b>
42–48V 50/60Hz	<b>W</b>	<b>XTCERENCOILHW</b>
110–130 Vdc	<b>AD</b>	<b>XTCERENCOILHAD</b>
200–240 Vdc	<b>BD</b>	<b>XTCERENCOILHBD</b>
24–27 Vdc	<b>TD</b>	<b>XTCERENCOILHTD</b>
48–60 Vdc	<b>WD</b>	<b>XTCERENCOILHWD</b>

**Replacement Coil—Frame L** <sup>①</sup>

Voltage	Coil Suffix	Catalog Number
110–250 Vac/Vdc	<b>A</b>	<b>XTCERENCOILLA</b>
250–500V 40–60	<b>C</b>	<b>XTCERENCOILLC</b>
24–48 Vdc	<b>TD</b>	<b>XTCERENCOILLTD</b>
48–110 Vac/Vdc	<b>Y</b>	<b>XTCERENCOILLY</b>

**Replacement Coil—Frame L, S-Series**

Voltage	Coil Suffix	Catalog Number
110–120V 50/60 Hz	<b>A</b>	<b>XTCSRENCOILLA</b>
220–240V 50/60 Hz	<b>B</b>	<b>XTCSRENCOILLB</b>

**Replacement Coil—Frame M** <sup>①</sup>

Voltage	Coil Suffix	Catalog Number
110–250 Vac/Vdc	<b>A</b>	<b>XTCERENCOILMA</b>
250–500V 40–60	<b>C</b>	<b>XTCERENCOILMC</b>
24–48 Vdc	<b>TD</b>	<b>XTCERENCOILMTD</b>
48–110 Vac/Vdc	<b>Y</b>	<b>XTCERENCOILMY</b>

**Replacement Coil—Frame M, S-Series**

Voltage	Coil Suffix	Catalog Number
110–120V 50/60 Hz	<b>A</b>	<b>XTCSRENCOILMA</b>
220–240V 50/60 Hz	<b>B</b>	<b>XTCSRENCOILMB</b>

**Replacement Coil—Frame N** <sup>①</sup>

Voltage	Coil Suffix	Catalog Number
110–250 Vac/Vdc	<b>A</b>	<b>XTCERENCOILNA</b>
250–500V 40–60	<b>C</b>	<b>XTCERENCOILNC</b>
48–110 Vac/Vdc	<b>Y</b>	<b>XTCERENCOILNY</b>

**Replacement Contact Kit**

For Use with...	Catalog Number
XTCE040D–XTCE065D	<b>XTCERENCONTACTD</b>
XTCE085F–XTCE095F	<b>XTCERENCONTACTF</b>
XTCE115G–XTCE150G	<b>XTCERENCONTACTG</b>
XTCE185H–XTCE225H	<b>XTCERENCONTACTH</b>
XTCE250L–XTCE300L	<b>XTCERENCONTACTL</b>
XTCE300M	<b>XTCERENCONTACTM300</b>
XTCE400M	<b>XTCERENCONTACTM400</b>
XTCE500M	<b>XTCERENCONTACTM500</b>

**Replacement Vacuum Tube Assembly**

For Use with...	Catalog Number
XTCE580N	<b>XTCERENVACT580</b>
XTCE650N	<b>XTCERENVACT650</b>
XTCE750N	<b>XTCERENVACT750</b>
XTCE820N	<b>XTCERENVACT820</b>

**Replacement Arc Chamber**

For Use with...	Catalog Number
XTCE250L	<b>XTCERENARC250</b>
XTCE300M	<b>XTCERENARC300</b>
XTCE400M	<b>XTCERENARC400</b>
XTCE500M–XTCE570M	<b>XTCERENARC500</b>

**Note**

<sup>①</sup> Electronic modules including coils.

## Technical Data and Specifications

### XT Contactors—Frame B

Description	XTCE007B	XTCE009B	XTCE012B	XTCE015B
<b>General</b>				
Standards	IEC/EN 60947, VDE 0660, UL, CSA, CCC, RoHS	IEC/EN 60947, VDE 0660, UL, CSA, CCC, RoHS	IEC/EN 60947, VDE 0660, UL, CSA, CCC, RoHS	IEC/EN 60947, VDE 0660, UL, CSA, CCC, RoHS
Weights in kg [lb]				
AC operated	0.23 [0.51]	0.23 [0.51]	0.23 [0.51]	0.23 [0.51]
DC operated	0.28 [0.62]	0.28 [0.62]	0.28 [0.62]	0.28 [0.62]
Mechanical life—operations	10,000,000	10,000,000	10,000,000	10,000,000
Mechanical operating frequency (ops/hr)				
AC operated	9000	9000	9000	5000
DC operated	9000	9000	9000	5000
Electrical life	See Curves, Page V5-T1-111	See Curves, Page V5-T1-111	See Curves, Page V5-T1-111	See Curves, Page V5-T1-111
Electrical operating frequency (ops/hr)—see Curves, Page V5-T1-111				
AC-1; 400V I <sub>e</sub>	800	800	800	800
AC-3; 400V I <sub>e</sub>	1000	1000	1000	1000
AC-4; 400V I <sub>e</sub>	300	300	300	300
Climatic proofing	③	③	③	③
Insulation voltage (U <sub>i</sub> ) Vac	690	690	690	690
Impulse withstand voltage (U <sub>imp</sub> ) Vac	8000	8000	8000	8000
Operational voltage (U <sub>a</sub> ) Vac	690	690	690	690
Safe isolation to VDE 0106 Part 101 and Part 101/A1				
Between coil and contacts (Vac)	400	400	400	400
Between contacts (Vac)	400	400	400	400
Making capacity up to 690V (amps) ①	112	112	144	155
Breaking capacity (amps)				
220/230V	70	90	120	124
380/400V	70	90	120	124
500V	50	70	100	100
660/690V	40	50	70	70
Short-circuit protection rating maximum fuse				
Type 2 coordination ②				
400V; gG/gL 500V	20	20	20	20
690V; gG/gL 690V	16	16	20	20
Type 1 coordination ②				
400V; gG/gL 500V	35	35	35	63
690V; gG/gL 690V	20	20	20	50
Degree of protection	IP20	IP20	IP20	IP20
Protection against direct contact when actuated from front (IEC 536)	Finger and back-of-hand proof	Finger and back-of-hand proof	Finger and back-of-hand proof	Finger and back-of-hand proof
Terminal capacity main cable—screw terminals				
Solid (mm <sup>2</sup> )	1 x (0.75–4) 2 x (0.75–2.5)	1 x (0.75–4) 2 x (0.75–2.5)	1 x (0.75–4) 2 x (0.75–2.5)	1 x (0.75–4) 2 x (0.75–2.5)
Flexible with ferrule (mm <sup>2</sup> )	1 x (0.75–2.5) 1 x (0.75–2.5)	1 x (0.75–2.5) 1 x (0.75–2.5)	1 x (0.75–2.5) 1 x (0.75–2.5)	1 x (0.75–2.5) 1 x (0.75–2.5)
Solid or stranded (AWG)	18–14	18–14	18–14	18–14
Terminal capacity control circuit cable—screw terminals				
Solid (mm <sup>2</sup> )	1 x (0.75–4) 2 x (0.75–2.5)	1 x (0.75–4) 2 x (0.75–2.5)	1 x (0.75–4) 2 x (0.75–2.5)	1 x (0.75–4) 2 x (0.75–2.5)

#### Notes

① Rated operational current: Making and breaking conditions to DC-13, L/R constant as stated.

② IEC 60947 Standard.

③ Damp heat, constant, to IEC 60068-2-78; damp heat, cyclical, to IEC 60068-2-30.

## XT Contactors—Frame B, continued

Description	XTCE007B	XTCE009B	XTCE012B	XTCE015B
<b>General, continued</b>				
Flexible with ferrule (mm <sup>2</sup> )	1 x (0.75–2.5) 1 x (0.75–2.5)	1 x (0.75–2.5) 1 x (0.75–2.5)	1 x (0.75–2.5) 1 x (0.75–2.5)	1 x (0.75–2.5) 1 x (0.75–2.5)
Solid or stranded (AWG)	18–14	18–14	18–14	18–14
Main cable and control circuit cable connection screw/bolt	M3.5	M3.5	M3.5	M3.5
Tightening torque				
Nm	1.2	1.2	1.2	1.2
Lb-in	10.6	10.6	10.6	10.6
<b>Tools</b>				
Main and control circuit cable—screw terminals	Size 2	Size 2	Size 2	Size 2
Pozidriv screwdriver	0.8 x 5.5	0.8 x 5.5	0.8 x 5.5	0.8 x 5.5
Standard screwdriver	1 x 6	1 x 6	1 x 6	1 x 6
<b>Terminal capacity main circuit cable—spring cage terminals</b>				
Solid (mm <sup>2</sup> )	1 x (0.75–2.5) 1 x (0.75–2.5)	1 x (0.75–2.5) 1 x (0.75–2.5)	1 x (0.75–2.5) 1 x (0.75–2.5)	1 x (0.75–2.5) 1 x (0.75–2.5)
Flexible (mm <sup>2</sup> )	1 x (0.75–2.5) 1 x (0.75–2.5)	1 x (0.75–2.5) 1 x (0.75–2.5)	1 x (0.75–2.5) 1 x (0.75–2.5)	1 x (0.75–2.5) 1 x (0.75–2.5)
Flexible with ferrule (mm <sup>2</sup> )	1 x (0.75–2.5) 1 x (0.75–2.5)	1 x (0.75–2.5) 1 x (0.75–2.5)	1 x (0.75–2.5) 1 x (0.75–2.5)	1 x (0.75–2.5) 1 x (0.75–2.5)
Solid or stranded (AWG)	18–14	18–14	18–14	18–14
<b>Terminal capacity control circuit cable—spring cage terminals</b>				
Solid (mm <sup>2</sup> )	1 x (0.75–2.5) 1 x (0.75–2.5)	1 x (0.75–2.5) 1 x (0.75–2.5)	1 x (0.75–2.5) 1 x (0.75–2.5)	1 x (0.75–2.5) 1 x (0.75–2.5)
Flexible (mm <sup>2</sup> )	1 x (0.75–2.5) 1 x (0.75–2.5)	1 x (0.75–2.5) 1 x (0.75–2.5)	1 x (0.75–2.5) 1 x (0.75–2.5)	1 x (0.75–2.5) 1 x (0.75–2.5)
Flexible with ferrule (mm <sup>2</sup> )	1 x (0.75–2.5) 1 x (0.75–2.5)	1 x (0.75–2.5) 1 x (0.75–2.5)	1 x (0.75–2.5) 1 x (0.75–2.5)	1 x (0.75–2.5) 1 x (0.75–2.5)
Solid or stranded (AWG)	18–14	18–14	18–14	18–14
<b>Tools</b>				
Main and control circuit cable—spring cage terminals				
Stripping length (mm)	10	10	10	10
Screwdriver blade width (mm)	3.5	3.5	3.5	3.5
<b>Mounting position, AC and DC operated</b>				
<b>Ambient temperature</b>				
Open	–25 to 60°C [–13 to 140°F]	–25 to 60°C [–13 to 140°F]	–25 to 60°C [–13 to 140°F]	–25 to 60°C [–13 to 140°F]
Enclosed	–25 to 40°C [–13 to 104°F]	–25 to 40°C [–13 to 104°F]	–25 to 40°C [–13 to 104°F]	–25 to 40°C [–13 to 104°F]
Ambient storage temperature	–40 to 80°C [–40 to 176°F]	–40 to 80°C [–40 to 176°F]	–40 to 80°C [–40 to 176°F]	–40 to 80°C [–40 to 176°F]
<b>Environmental</b>				
<b>Mechanical shock resistance (IEC/EN 60068-2-27)</b>				
<b>Half-sinusoidal shock 10 ms</b>				
Main contact—NO contact	10g	10g	10g	10g
Auxiliary contact—NO contact	7g	7g	7g	7g
Auxiliary contact—NC contact	5g	5g	5g	5g
Overvoltage category/pollution degree	III/3	III/3	III/3	III/3

## XT Contactors—Frames C–D

Description	XTCE018C	XTCE025C	XTCE032C	XTCE040D	XTCE050D	XTCE065D, XTCE072D
<b>General</b>						
Standards	IEC/EN 60947, VDE 0660, UL, CSA, CCC, RoHS	IEC/EN 60947, VDE 0660, UL, CSA, CCC, RoHS	IEC/EN 60947, VDE 0660, UL, CSA, CCC, RoHS	IEC/EN 60947, VDE 0660, UL, CSA, CCC, RoHS	IEC/EN 60947, VDE 0660, UL, CSA, CCC, RoHS	IEC/EN 60947, VDE 0660, UL, CSA, CCC, RoHS
Weights in kg [lb]						
AC operated	0.42 [0.93]	0.42 [0.93]	0.42 [0.93]	0.9 [2.0]	0.9 [2.0]	0.9 [2.0]
DC operated	0.48 [1.06]	0.48 [1.06]	0.48 [1.06]	1.1 [2.4]	1.1 [2.4]	1.1 [2.4]
Mechanical life—operations	10,000,000	10,000,000	10,000,000	10,000,000	10,000,000	10,000,000
Mechanical operating frequency (ops/hr)						
AC operated	5000	5000	5000	5000	5000	5000
DC operated	5000	5000	5000	5000	5000	5000
Electrical mechanical operating frequency (ops/hr)—see Curves, <b>Page V5-T1-111</b>						
AC-1; 400V I <sub>e</sub>	800	800	800	800	800	800
AC-3; 400V I <sub>e</sub>	800	800	800	800	800	800
AC-4; 400V I <sub>e</sub>	300	300	300	300	300	300
Climatic proofing	②	②	②	②	②	②
Insulation voltage (U <sub>i</sub> ) Vac	690	690	690	690	690	690
Impulse withstand voltage (U <sub>imp</sub> ) Vac	8000	8000	8000	8000	8000	8000
Operating voltage (U <sub>e</sub> ) Vac	690	690	690	690	690	690
Safe isolation to VDE 0106 Part 101 and Part 101/A1						
Between coil and contacts (Vac)	440	440	440	440	440	440
Between contacts (Vac)	238	440	440	440	440	440
Making capacity (amps)	238	350	384	560	700	910
Breaking capacity (amps)						
220/230V	170	250	320	400	500	650
380/400V	170	250	320	400	500	650
500V	170	250	320	400	500	650
660/690V	120	150	180	250	320	370
Short-circuit protection rating maximum fuse (amps)						
Type 2 coordination ①						
400V; gG/gL 500V	25	35	63	63	80	125
690V; gG/gL 690V	25	35	35	50	63	80
Type 1 coordination ①						
400V; gG/gL 500V	63	100	125	125	160	250
690V; gG/gL 690V	50	50	63	80	80	100
Degree of protection	IP00	IP00	IP00	IP00	IP00	IP00
Protection against direct contact when actuated from front (IEC 536)	Finger and back-of-hand proof	Finger and back-of-hand proof	Finger and back-of-hand proof	Finger and back-of-hand proof	Finger and back-of-hand proof	Finger and back-of-hand proof
Terminal capacity main cable—screw terminals						
Solid (mm <sup>2</sup> )	1 x (0.75–16) 2 x (0.75–10)	1 x (0.75–16) 2 x (0.75–10)	1 x (0.75–16) 2 x (0.75–10)	1 x (0.75–16) 2 x (0.75–10)	1 x (0.75–16) 2 x (0.75–10)	1 x (0.75–16) 2 x (0.75–10)
Flexible with ferrule (mm <sup>2</sup> )	1 x (0.75–16) 2 x (0.75–10)	1 x (0.75–16) 2 x (0.75–10)	1 x (0.75–16) 2 x (0.75–10)	1 x (2.5–35) 2 x (2.5–25)	1 x (2.5–35) 2 x (2.5–25)	1 x (2.5–35) 2 x (2.5–25)
Stranded (mm <sup>2</sup> )	1 x 16	1 x 16	1 x 16	1 x (16–50) 2 x (16–35)	1 x (16–50) 2 x (16–35)	1 x (16–50) 2 x (16–35)
Solid or stranded (AWG)	18–6	18–6	18–6	12–2	12–2	12–2
Flat conductor (number of segments x width x thickness) (mm)	—	—	—	2 x (6 x 9 x 0.8)	2 x (6 x 9 x 0.8)	2 x (6 x 9 x 0.8)

**Notes**

① IEC 60947 Standard.

② Damp heat, constant, to IEC 60068-2-78; damp heat, cyclic, to IEC 60 068-2-30.



## XT Contactors—Frames C–D, continued

Description	XTCE018C	XTCE025C	XTCE032C	XTCE040D	XTCE050D	XTCE065D, XTCE072D
<b>General, continued</b>						
Main cable connection screw/bolt	M5	M5	M5	M6	M6	M6
Tightening torque						
Nm	3	3	3	3.3	3.3	3.3
Lb-in	26.6	26.6	26.6	29.2	29.2	29.2
Terminal capacity control circuit cable—screw terminals						
Solid (mm <sup>2</sup> )	1 x (0.75–4) 2 x (0.75–4)	1 x (0.75–4) 2 x (0.75–4)	1 x (0.75–4) 2 x (0.75–4)	1 x (0.75–4) 2 x (0.75–4)	1 x (0.75–4) 2 x (0.75–4)	1 x (0.75–4) 2 x (0.75–4)
Flexible with ferrule (mm <sup>2</sup> )	1 x (0.75–2.5) 2 x (0.75–2.5)	1 x (0.75–2.5) 2 x (0.75–2.5)	1 x (0.75–2.5) 2 x (0.75–2.5)	1 x (0.75–2.5) 2 x (0.75–2.5)	1 x (0.75–2.5) 2 x (0.75–2.5)	1 x (0.75–2.5) 2 x (0.75–2.5)
Solid or stranded (AWG)	18–14	18–14	18–14	18–14	18–14	18–14
Control circuit cable connection screw/bolt	M3.5	M3.5	M3.5	M3.5	M3.5	M3.5
Tightening torque						
Nm	1.2	1.2	1.2	1.2	1.2	1.2
Lb-in	10.6	10.6	10.6	10.6	10.6	10.6
Tools						
Main and control circuit cable—screw terminals	Size 2	Size 2	Size 2	Size 2	Size 2	Size 2
Pozidriv screwdriver	0.8 x 5.5	0.8 x 5.5	0.8 x 5.5	0.8 x 5.5	0.8 x 5.5	0.8 x 5.5
Standard screwdriver	1 x 6	1 x 6	1 x 6	1 x 6	1 x 6	1 x 6
Terminal capacity control circuit cable—spring cage terminals						
Solid (mm <sup>2</sup> )	1 x (0.75–2.5) 2 x (0.75–2.5)	1 x (0.75–2.5) 2 x (0.75–2.5)	1 x (0.75–2.5) 2 x (0.75–2.5)	1 x (0.75–2.5) 2 x (0.75–2.5)	1 x (0.75–2.5) 2 x (0.75–2.5)	1 x (0.75–2.5) 2 x (0.75–2.5)
Flexible (mm <sup>2</sup> )	1 x (0.75–2.5) 2 x (0.75–2.5)	1 x (0.75–2.5) 2 x (0.75–2.5)	1 x (0.75–2.5) 2 x (0.75–2.5)	1 x (0.75–2.5) 2 x (0.75–2.5)	1 x (0.75–2.5) 2 x (0.75–2.5)	1 x (0.75–2.5) 2 x (0.75–2.5)
Flexible with ferrule (mm <sup>2</sup> )	1 x (0.75–2.5) 2 x (0.75–2.5)	1 x (0.75–2.5) 2 x (0.75–2.5)	1 x (0.75–2.5) 2 x (0.75–2.5)	1 x (0.75–2.5) 2 x (0.75–2.5)	1 x (0.75–2.5) 2 x (0.75–2.5)	1 x (0.75–2.5) 2 x (0.75–2.5)
Solid or stranded (AWG)	18–14	18–14	18–14	18–14	18–14	18–14
Tools						
Main and control circuit cable—spring cage terminals						
Stripping length (mm)	10	10	10	10	10	10
Screwdriver blade width (mm)	3.5	3.5	3.5	3.5	3.5	3.5
Mounting position, AC and DC operated						
Ambient temperature						
Open	–25 to 60°C [–13 to 140°F]	–25 to 60°C [–13 to 140°F]	–25 to 60°C [–13 to 140°F]	–25 to 60°C [–13 to 140°F]	–25 to 60°C [–13 to 140°F]	–25 to 60°C [–13 to 140°F]
Enclosed	–25 to 40°C [–13 to 104°F]	–25 to 40°C [–13 to 104°F]	–25 to 40°C [–13 to 104°F]	–25 to 40°C [–13 to 104°F]	–25 to 40°C [–13 to 104°F]	–25 to 40°C [–13 to 104°F]
Ambient storage temperature	–40 to 80°C [–40 to 176°F]	–40 to 80°C [–40 to 176°F]	–40 to 80°C [–40 to 176°F]	–40 to 80°C [–40 to 176°F]	–40 to 80°C [–40 to 176°F]	–40 to 80°C [–40 to 176°F]
<b>Environmental</b>						
Mechanical shock resistance (IEC/EN 60068-2-27)						
Main contact—NO Contact	10	10	10	10	1	1
Auxiliary contact—NO Contact	7	7	7	7	7	7
Auxiliary contact—NC Contact	5	5	5	5	5	5
Overvoltage category/pollution degree	III/3	III/3	III/3	III/3	III/3	III/3

## XT Contactors—Frames F–G

Description	XTCE080F	XTCE095F	XTCE115G	XTCE150G	XTCE170G
<b>General</b>					
Standards	IEC/EN 60947, VDE 0660, UL, CSA, CCC, RoHS	IEC/EN 60947, VDE 0660, UL, CSA, CCC, RoHS	IEC/EN 60947, VDE 0660, UL, CSA, CCC, RoHS	IEC/EN 60947, VDE 0660, UL, CSA, CCC, RoHS	IEC/EN 60947, VDE 0660, UL, CSA, CCC, RoHS
Weights in kg [lb]					
AC operated	2 [4.41]	2 [4.41]	2 [4.41]	2 [4.41]	2 [4.41]
DC operated	2.1 [4.63]	2.1 [4.63]	2.1 [4.63]	2.1 [4.63]	2.1 [4.63]
Mechanical life—operations	10,000,000	10,000,000	10,000,000	10,000,000	10,000,000
Mechanical operating frequency (ops/hr)					
AC operated	3600	3600	3600	3600	3600
DC operated	3600	3600	3600	3600	3600
Electrical mechanical operating frequency (ops/hr)— see Curves, <b>Page V5-T1-111</b>					
AC-1; 400V I <sub>e</sub>	800	800	800	800	800
AC-3; 400V I <sub>e</sub>	800	800	800	800	800
AC-4; 400V I <sub>e</sub>	300	300	300	300	300
Climatic proofing	②	②	②	②	②
Insulation voltage (U <sub>i</sub> ) Vac	690	690	690	690	690
Impulse withstand voltage (U <sub>imp</sub> ) Vac	8000	8000	8000	8000	8000
Operational voltage (U <sub>o</sub> ) Vac	690	690	690	690	690
Safe isolation to VDE 0106 Part 101 and Part 101/A1					
Between coil and contacts (Vac)	690	690	690	690	690
Between contacts (Vac)	690	690	690	690	690
Making capacity (amps)	1120	1330	1610	2100	2100
Breaking capacity (amps)					
220/230V	800	950	1150	1500	1500
380/400V	800	950	1150	1500	1500
500V	800	950	1150	1500	1500
660/690V	650	800	1100	1200	1320
1000V	—	—	—	—	—
Short-circuit protection rating maximum fuse					
Type 2 coordination ①					
400V; gG/gL 500V	160	160	250	25	400
690V; gG/gL 690V	160	160	25	250	25
Type 1 coordination ①					
400V; gG/gL 500V	250	25	250	250	400
690V; gG/gL 690V	200	200	250	250	250
Degree of protection	IP00	IP00	IP00	IP00	IP00
Protection against direct contact when actuated from front (IEC 536)	Finger and back-of-hand proof	Finger and back-of-hand proof	Finger and back-of-hand proof	Finger and back-of-hand proof	Finger and back-of-hand proof
Terminal capacity main cable—screw terminals					
Solid (mm <sup>2</sup> )					
Flexible with ferrule (mm <sup>2</sup> )	1 x (10–95) 2 x (10–70)	1 x (10–95) 2 x (10–70)	1 x (10–95) 2 x (10–70)	1 x (10–95) 2 x (10–70)	1 x (10–95) 2 x (10–70)
Stranded (mm <sup>2</sup> )					
Flat conductor (number of segments x width x thickness) (mm)	1 x (16–95) 2 x (16–70)	1 x (16–95) 2 x (16–70)	1 x (16–95) 2 x (16–70)	1 x (16–95) 2 x (16–70)	1 x (16–95) 2 x (16–70)
Flat conductor (number of segments x width x thickness) (mm)	2 x (6 x 16 x 0.8)	2 x (6 x 16 x 0.8)	2 x (6 x 16 x 0.8)	2 x (6 x 16 x 0.8)	2 x (6 x 16 x 0.8)
Solid or stranded (AWG)	8–3/0	8–3/0	8–3/0	8–3/0	8–3/0
Main cable connection screw/bolt	M10	M10	M10	M10	M10
Tightening torque					
Nm	14	14	14	14	14
Lb-in	123.9	123.9	123.9	123.9	123.9

**Notes**

① IEC 60947 Standard.

② Damp heat, constant, to IEC 60068-2-78; damp heat, cyclic, to IEC 60 068-2-30.

## XT Contactors—Frames F–G, continued

Description	XTCE080F	XTCE095F	XTCE115G	XTCE150G	XTCE170G
<b>General, continued</b>					
Terminal capacity control circuit cable—screw terminals					
Solid (mm <sup>2</sup> )	1 x (0.75–4) 1 x (0.75–4)	1 x (0.75–4) 1 x (0.75–4)	1 x (0.75–4) 1 x (0.75–4)	1 x (0.75–4) 1 x (0.75–4)	1 x (0.75–4) 1 x (0.75–4)
Flexible with ferrule (mm <sup>2</sup> )	1 x (0.75–2.5) 2 x (0.75–2.5)	1 x (0.75–2.5) 2 x (0.75–2.5)	1 x (0.75–2.5) 2 x (0.75–2.5)	1 x (0.75–2.5) 2 x (0.75–2.5)	1 x (0.75–2.5) 2 x (0.75–2.5)
Solid or stranded (AWG)	18–14	18–14	18–14	18–14	18–14
Control circuit cable connection screw/bolt	M3.5	M3.5	M3.5	M3.5	M3.5
Tightening torque					
Nm	1.2	1.2	1.2	1.2	1.2
Lb-in	10.6	10.6	10.6	10.6	10.6
Tools					
Main circuit cable—screw terminals					
Hexagon socket-head spanner (mm)	5	5	5	5	5
Control circuit cable—screw terminals					
Pozidriv screwdriver	Size 2	Size 2	Size 2	Size 2	Size 2
Standard screwdriver	1 x 6, 0.8 x 5.5	1 x 6, 0.8 x 5.5	1 x 6, 0.8 x 5.5	1 x 6, 0.8 x 5.5	1 x 6, 0.8 x 5.5
Terminal capacity control circuit cable—spring cage terminals					
Solid (mm <sup>2</sup> )	1 x (0.75–2.5) 2 x (0.75–2.5)	1 x (0.75–2.5) 2 x (0.75–2.5)	1 x (0.75–2.5) 2 x (0.75–2.5)	1 x (0.75–2.5) 2 x (0.75–2.5)	1 x (0.75–2.5) 2 x (0.75–2.5)
Flexible (mm <sup>2</sup> )	1 x (0.75–2.5) 2 x (0.75–2.5)	1 x (0.75–2.5) 2 x (0.75–2.5)	1 x (0.75–2.5) 2 x (0.75–2.5)	1 x (0.75–2.5) 2 x (0.75–2.5)	1 x (0.75–2.5) 2 x (0.75–2.5)
Flexible with ferrule (mm <sup>2</sup> )	1 x (0.75–2.5) 2 x (0.75–2.5)	1 x (0.75–2.5) 2 x (0.75–2.5)	1 x (0.75–2.5) 2 x (0.75–2.5)	1 x (0.75–2.5) 2 x (0.75–2.5)	1 x (0.75–2.5) 2 x (0.75–2.5)
Solid or stranded (AWG)	18–14	18–14	18–14	18–14	18–14
Tools					
Control circuit cable—spring cage terminals					
Stripping length (mm)	10	10	10	10	10
Screwdriver blade width (mm)	3.5	3.5	3.5	3.5	3.5
Mounting position, AC and DC operated					
Ambient temperature					
Open	–25 to 60°C [–13 to 140°F]	–25 to 60°C [–13 to 140°F]	–25 to 60°C [–13 to 140°F]	–25 to 60°C [–13 to 140°F]	–25 to 60°C [–13 to 140°F]
Enclosed	–25 to 40°C [–13 to 104°F]	–25 to 40°C [–13 to 104°F]	–25 to 40°C [–13 to 104°F]	–25 to 40°C [–13 to 104°F]	–25 to 40°C [–13 to 104°F]
Ambient storage temperature	–40 to 80°C [–40 to 176°F]	–40 to 80°C [–40 to 176°F]	–40 to 80°C [–40 to 176°F]	–40 to 80°C [–40 to 176°F]	–40 to 80°C [–40 to 176°F]
<b>Environmental</b>					
Mechanical shock resistance (IEC/EN 60068-2-27)					
Half-sinusoidal shock 10 ms					
Main contact—NO contact	10g	10g	10g	10g	10g
Auxiliary contact—NO contact	7g	7g	7g	7g	7g
Auxiliary contact—NC contact	5g	5g	5g	5g	5g
Overvoltage category/pollution degree	III/3	III/3	III/3	III/3	III/3

## XT Contactors—Frames H–M

Description	XTCE185H	XTCE225H	XTCE250L, XTCS250L	XTCE300L, XTCS300L	XTCE400M XTCS400M	XTCE500M, XTCS500M	XTCE570M XTCS570M
<b>General</b>							
Standards	IEC/EN 60947, VDE 0660, UL, CSA	IEC/EN 60947, VDE 0660, UL, CSA	IEC/EN 60947, VDE 0660, UL, CSA	IEC/EN 60947, VDE 0660, UL, CSA	IEC/EN 60947, VDE 0660, UL, CSA	IEC/EN 60947, VDE 0660, UL, CSA	IEC/EN 60947, VDE 0660, UL, CSA
Weights in kg [lb]	3.2 [7.1]	3.2 [7.1]	6.5 [14.3]	6.5 [14.3]	8 [18]	8 [18]	8 [18]
Mechanical life—operations	10,000,000	10,000,000	10,000,000	10,000,000	7,000,000	7,000,000	7,000,000
Mechanical operating frequency (ops/hr)							
AC operated	3000	3000	3000	3000	2000	2000	2000
DC operated	3000	3000	3000	3000	2000	2000	2000
Mechanical operating frequency (ops/hr)	See <b>Page V5-T1-93</b>						
Climatic proofing	②	②	②	②	②	②	②
Insulation voltage (U <sub>i</sub> ) Vac	1000	1000	1000	1000	1000	1000	1000
Impulse withstand voltage (U <sub>imp</sub> ) Vac	8000	8000	8000	8000	8000	8000	8000
Operating voltage (U <sub>e</sub> ) Vac	1000	1000	1000	1000	1000	1000	1000
Safe isolation to VDE 0106 Part 101 and Part 101/A1							
Between coil and contacts (Vac)	500	500	500	500	500	500	500
Between contacts (Vac)	500	500	500	500	500	500	500
Making capacity (amps)	2700	2700	3000	3600	5500	5500	5500
Breaking capacity (amps)							
Between coil and contacts (Vac)							
220/230V	2250	2250	2500	3000	5000	5000	5000
380/400V	2250	2250	2500	3000	5000	5000	5000
500V	2250	2250	2500	3000	5000	5000	5000
660/690V	2250	2250	2500	3000	5000	5000	5000
1000V	760	760	760	950	950	950	950
Short-circuit protection rating maximum fuse							
Type 2 coordination ①							
400V; gG/gL 500V	315	315	315	315	500	500	500
690V; gG/gL 690V	250	250	315	315	500	500	500
1000V; gG/gL 1000V	160	160	160	160	200	200	200
Degree of protection	IP00	IP00	IP00	IP00	IP00	IP00	IP00
Protection against direct contact when actuated from front (IEC 536)	Finger and back-of-hand proof with terminal shroud or terminal block						
Main cable cross-section							
Flexible with cable lug (mm <sup>2</sup> )	50–185	50–185	50–240	50–240	50–240	50–240	50–240
Stranded with cable lug (mm <sup>2</sup> )	50–185	70–185	70–240	70–240	70–240	70–240	70–240
Solid or stranded (AWG)	1/0–350 kcmil	2/0–250 kcmil	1/0–250 kcmil	2/0–500 kcmil	1/0–250 kcmil	1/0–250 kcmil	1/0–250 kcmil
Flat conductor (mm)	③	③	③	③	③	③	③
Busbar—width in mm	32	32	25	25	25	30	30
Main cable connection screw/bolt	M10	M10	M10	M10	M10	M10	M10
Tightening torque							
Nm	24	24	24	24	2	2	2
Lb-in	213	213	213	213	213	213	213

**Notes**

- ① IEC 60947 Standard.  
 ② Damp heat, constant, to IEC 60068-2-78; damp heat, cyclic, to IEC 60 068-2-30.  
 ③ Screw tightening with flat cable terminal or cable terminal blocks. See terminal capacity for cable terminal blocks.

## XT Contactors—Frames H–M, continued

Description	XTCE185H	XTCE225H	XTCE250L, XTCS250L	XTCE300L, XTCS300L	XTCE400M XTCS400M	XTCE500M, XTCS500M	XTCE570M XTCS570M
<b>General, continued</b>							
Control circuit cable cross-sections							
Solid (mm <sup>2</sup> )	1 x (0.75–2.5) 2 x (0.75–2.5)	1 x (0.75–2.5) 2 x (0.75–2.5)	1 x (0.75–2.5) 2 x (0.75–2.5)	1 x (0.75–2.5) 2 x (0.75–2.5)	1 x (0.75–2.5) 2 x (0.75–2.5)	1 x (0.75–2.5) 2 x (0.75–2.5)	1 x (0.75–2.5) 2 x (0.75–2.5)
Flexible with ferrule (mm <sup>2</sup> )	1 x (0.75–2.5) 2 x (0.75–2.5)	1 x (0.75–2.5) 2 x (0.75–2.5)	1 x (0.75–2.5) 2 x (0.75–2.5)	1 x (0.75–2.5) 2 x (0.75–2.5)	1 x (0.75–2.5) 2 x (0.75–2.5)	1 x (0.75–2.5) 2 x (0.75–2.5)	1 x (0.75–2.5) 2 x (0.75–2.5)
Solid or stranded (AWG)	2 x (18–12)	2 x (18–12)	2 x (18–12)	2 x (18–12)	2 x (18–12)	2 x (18–12)	2 x (18–12)
Control circuit cable connection screw/bolt	M3.5	M3.5	M3.5	M3.5	M3.5	M3.5	M3.5
Tightening torque							
Nm	1.2	1.2	1.2	1.2	1.2	1.2	1.2
Lb-in	10.6	10.6	10.6	10.6	10.6	10.6	10.6
Tools							
Main cable wrench	16 mm	16 mm	16 mm	16 mm	16 mm	16 mm	16 mm
Control circuit cable pozidriv screwdriver	Size 2	Size 2	Size 2	Size 2	Size 2	Size 2	Size 2
Mounting position, AC and DC operated							
Ambient temperature	–25 to 60°C [–13 to 140°F]	–25 to 60°C [–13 to 140°F]	–25 to 60°C [–13 to 140°F]	–25 to 60°C [–13 to 140°F]	–25 to 60°C [–13 to 140°F]	–25 to 60°C [–13 to 140°F]	–25 to 60°C [–13 to 140°F]
Ambient storage temperature	–40 to 80°C [–40 to 176°F]	–40 to 80°C [–40 to 176°F]	–40 to 80°C [–40 to 176°F]	–40 to 80°C [–40 to 176°F]	–40 to 80°C [–40 to 176°F]	–40 to 80°C [–40 to 176°F]	–40 to 80°C [–40 to 176°F]
<b>Environmental</b>							
Mechanical shock							
Resistance (IEC/EN 60068-2-27)							
Half-sinusoidal shock 10 ms							
Main contact—NO contact	10g	10g	10g	10g	10g	10g	10g
Auxiliary contact—NO contact	10g	10g	10g	10g	10g	10g	10g
Auxiliary contact—NC contact	8g	8g	8g	8g	8g	8g	8g
Overtoltage category/pollution degree	III/3	III/3	III/3	III/3	III/3	III/3	III/3
Switching capacity, kVAR <sup>①</sup>							
Individual compensation							
230V	—	—	—	—	—	—	—
400/420/440V	—	—	—	—	—	—	—
525V	220	220	—	307	—	—	—
690V	133	133	—	177	—	—	—
Group compensation, with choke							
230V	—	—	100	—	160	160	160
400/420/440V	—	—	190	—	280	280	280
525V	—	—	260	—	370	370	370
690V	—	—	340	—	480	480	480

**Note**

<sup>①</sup> When using contactors for group compensation, a minimum inductance of approx. 6  $\mu$ h per capacitor must be available to limit the high inrush current peaks. This corresponds to an air-cored coil with five windings and a coil diameter of approximately 140 mm. The conductor cross-section must be selected according to the rated current per phase.

## XT Contactors—Frames N–R

Description	XTCE580N	XTCE650N	XTCE750N, XTCE820N	XTCEC10N	XTCEC14P	XTCEC16R, XTCEC20R
<b>General</b>						
Standards	IEC/EN 60947, VDE 0660, UL, CSA	IEC/EN 60947, VDE 0660, UL, CSA	IEC/EN 60947, VDE 0660, UL, CSA	IEC/EN 60947, VDE 0660, UL, CSA	IEC/EN 60947, VDE 0660, UL, CSA	IEC/EN 60947, VDE 0660, UL, CSA
Weights in kg [lb]	15 [33]	15 [33]	15 [33]	15 [33]	15, [33]	32 [70]
Mechanical life—operations	5,000,000	5,000,000	5,000,000	5,000,000	5,000,000	5,000,000
Mechanical operating frequency (ops/hr)						
AC operated	1000	1000	1000	1000	1000	1000
DC operated	1000	1000	1000	1000	1000	1000
Maximum operating frequency (ops/hr)	See Page V5-T1-113					
Climatic proofing	②	②	②	②	②	②
Insulation voltage (U <sub>i</sub> ) Vac	1000	1000	1000	1000	1000	1000
Impulse withstand voltage (U <sub>imp</sub> ) Vac	8000	8000	8000	8000	8000	8000
Operating voltage (U <sub>e</sub> ) Vac	1000	1000	1000	1000	1000	1000
Safe isolation to VDE 0106 Part 101 and Part 101/A1						
Between coil and contacts (Vac)	500	500	500	500	500	500
Between contacts (Vac)	500	500	500	500	500	500
Making capacity (amps)	7800	7800	9840	9840	9840	19000, 9840
Breaking capacity (amps)						
220/230V	6500	6500	8200	8200	8200	16000, 8200
380/400V	6500	6500	8200	8200	8200	16000, 8200
500V	6500	6500	8200	8200	8200	16000, 8200
660/690V	6500	6500	8200	8200	8200	16000, 8200
1000V	4350	4350	5800	5800	5800	5800
Short-circuit protection rating maximum fuse						
Type 2 coordination ①						
400V; gG/gL 500V	630	630	630	630	—	—
690V; gG/gL 690V	630	630	630	630	—	—
1000V; gG/gL 1000V	500	500	630	630	—	—
Type 1 coordination ①						
400V; gG/gL 500V	1000	1000	1200	1200	—	—
690V; gG/gL 690V	1000	1000	1200	1200	—	—
1000V; gG/gL 1000V	630	630	800	800	—	—
Degree of protection	IP00	IP00	IP00	IP00	IP00	IP00
Protection against direct contact when actuated from front (IEC 536)	Finger and back-of-hand proof with terminal shroud or terminal block	Finger and back-of-hand proof with terminal shroud or terminal block	Finger and back-of-hand proof with terminal shroud or terminal block	Finger and back-of-hand proof with terminal shroud or terminal block	Finger and back-of-hand proof with terminal shroud or terminal block	Finger and back-of-hand proof with terminal shroud or terminal block
Main cable cross-section						
Flexible with cable lug (mm <sup>2</sup> )	50-240	50-240	50-240	50-240	50-240	50-240
Stranded with cable lug (mm <sup>2</sup> )	70-240	70-240	70-240	70-240	70-240	70-240
Solid or stranded (AWG)	2/0–500 kcmil	2/0–500 kcmil	2/0–500 kcmil	2/0–500 kcmil	2/0–500 kcmil	2/0–500 kcmil
Flat conductor (mm)	③	③	③	③	③	③
Busbar—width in mm	50	50	50	50	50	50
Main cable connection screw/bolt	M10	M10	M12	M12	M12	M1
Tightening torque						
Nm	24	24	35	35	35	35
Lb-in	213	213	311	311	311	311

**Notes**

- ① IEC 60947 Standard.  
 ② Damp heat, constant, to IEC 60068-2-78; damp heat, cyclic, to IEC 60 068-2-30.  
 ③ Screw tightening with flat cable terminal or cable terminal blocks. See terminal capacity for cable terminal blocks.

## XT Contactors—Frames N–R, continued

Description	XTCE580N	XTCE650N	XTCE750N, XTCE820N	XTCEC10N	XTCEC14P	XTCEC16R, XTCEC20R
<b>General, continued</b>						
Control circuit cable cross-sections						
Solid (mm <sup>2</sup> )	1 x (0.75–2.5) 2 x (0.75–2.5)	1 x (0.75–2.5) 2 x (0.75–2.5)	1 x (0.75–2.5) 2 x (0.75–2.5)	1 x (0.75–2.5) 2 x (0.75–2.5)	1 x (0.75–2.5) 2 x (0.75–2.5)	1 x (0.75–2.5) 2 x (0.75–2.5)
Flexible with ferrule (mm <sup>2</sup> )	1 x (0.75–2.5) 2 x (0.75–2.5)	1 x (0.75–2.5) 2 x (0.75–2.5)	1 x (0.75–2.5) 2 x (0.75–2.5)	1 x (0.75–2.5) 2 x (0.75–2.5)	1 x (0.75–2.5) 2 x (0.75–2.5)	1 x (0.75–2.5) 2 x (0.75–2.5)
Solid or stranded (AWG)	2 x (18–12)	2 x (18–12)	2 x (18–12)	2 x (18–12)	2 x (18–12)	2 x (18–12)
Control circuit cable connection screw/bolt	M3.5	M3.5	M3.5	M3.5	M3.5	M3.5
Tightening torque						
Nm	1.2	1.2	1.2	1.2	1.2	1.2
Lb-in	10.6	10.6	10.6	10.6	10.6	10.6
Tools						
Main cable wrench	16 mm	16 mm	18 mm	18 mm	18 mm	18 mm
Control circuit cable pozidriv screwdriver	Size 2	Size 2	Size 2	Size 2	Size 2	Size 2
Mounting position, AC and DC operated						
Ambient temperature	–25 to 60°C [–13 to 140°F]	–25 to 60°C [–13 to 140°F]	–25 to 60°C [–13 to 140°F]	–25 to 60°C [–13 to 140°F]	–25 to 60°C [–13 to 140°F]	–25 to 60°C [–13 to 140°F]
Ambient storage temperature	–40 to 80°C [–40 to 176°F]	–40 to 80°C [–40 to 176°F]	–40 to 80°C [–40 to 176°F]	–40 to 80°C [–40 to 176°F]	–40 to 80°C [–40 to 176°F]	–40 to 80°C [–40 to 176°F]
<b>Environmental</b>						
Mechanical shock resistance (IEC/EN 60068-2-27)						
Half-sinusoidal shock 10 ms (g)						
Main contact—NO contact	10	10	10	10	10	10
Auxiliary contact—NO contact	10	10	10	10	10	10
Auxiliary contact—NC contact	8	8	8	8	8	8
Overtoltage category/pollution degree	III/3	III/3	III/3	III/3	III/3	III/3
Switching capacity, kVAR <sup>①</sup>						
Individual compensation						
230V	175	—	—	—	—	—
400/420/440V	300	—	—	—	—	—
525V	400	—	—	—	—	—
690V	300	—	—	—	—	—

**Note**

<sup>①</sup> When using contactors for group compensation, a minimum inductance of approx. 6 uH per capacitor must be available to limit the high inrush current peaks. This corresponds to an air-cored coil with five windings and a coil diameter of approximately 140 mm. The conductor cross-section must be selected according to the rated current per phase.

## Coil Data—Frames B–D

Description	XTCE007B	XTCE009B	XTCE012B, XTCF020B	XTCE015B	XTCE018C	XTCE025C	XTCE032C	XTCE040D	XTCE050D	XTCE065D, XTCE072D
<b>Voltage Tolerance</b>										
Pickup (x U <sub>c</sub> )										
AC operated	0.8–1.1	0.8–1.1	0.8–1.1	0.8–1.1	0.8–1.1	0.8–1.1	0.8–1.1	0.8–1.1	0.8–1.1	0.8–1.1
DC operated	0.8–1.1 <sup>①</sup>	0.8–1.1 <sup>①</sup>	0.8–1.1 <sup>①</sup>	0.8–1.1 <sup>①</sup>	0.7–1.2 <sup>②</sup>	0.7–1.2 <sup>②</sup>	0.7–1.2 <sup>②</sup>	0.7–1.2 <sup>②</sup>	0.7–1.2 <sup>②</sup>	0.7–1.2 <sup>②</sup>
Dropout (x U <sub>c</sub> )										
AC operated	0.3–0.6	0.3–0.6	0.3–0.6	0.3–0.6	0.3–0.6	0.3–0.6	0.3–0.6	0.3–0.6	0.3–0.6	0.3–0.6
DC operated	0.15–0.6	0.15–0.6	0.15–0.6	0.15–0.6	0.15–0.6	0.15–0.6	0.15–0.6	0.15–0.6	0.15–0.6	0.15–0.6
<b>Power Consumption of the Coil at Cold State and 1.0 x U<sub>c</sub></b>										
AC operated										
Single-voltage coil 50 Hz										
Pickup VA	24	24	24	24	52	52	52	149	149	149
Pickup W	19	19	19	19	40	40	40	80	80	80
Sealing VA	3.4	3.4	3.4	3.4	7.1	7.1	7.1	16	16	16
Sealing W	1.2	1.2	1.2	1.2	2.1	2.1	2.1	4.3	4.3	4.3
Single-voltage coil 60 Hz										
Pickup VA	30	30	30	30	67	67	67	178	178	178
Pickup W	23	23	23	23	50	50	50	117	117	117
Sealing VA	4.4	4.4	4.4	4.4	8.7	8.7	8.7	19	19	19
Sealing W	1.4	1.4	1.4	1.4	2.6	2.6	2.6	5.3	5.3	5.3
50/60 Hz										
Pickup VA	27 25	27 25	27 25	27 25	62 58	62 58	62 58	168 154	168 154	168 154
Pickup W	22 21	22 21	22 21	22 21	48 43	48 43	48 43	120 43	120 43	120 43
Sealing VA	4.2 3.3	4.2 3.3	4.2 3.3	4.2 3.3	9.1 6.5	9.1 6.5	9.1 6.5	22 14	22 14	22 14
Sealing W	1.4 1.2	1.4 1.2	1.4 1.2	1.4 1.2	2.5 2	2.5 2	2.5 2	5.3 4.3	5.3 4.3	5.3 4.3
DC operated										
Pickup W	3	3	4.5	4.5	12 at 24V	12 at 24V	12 at 24V	24 at 24V	24 at 24V	24 at 24V
Sealing W	3	3	4.5	4.5	0.5 at 24V	0.5 at 24V	0.5 at 24V	0.5 at 24V	0.5 at 24V	0.5 at 24V
Duty factor (%DF)	100	100	100	100	100	100	100	100	100	100
<b>Switching Time at 100% U<sub>c</sub> (Approximate Values)</b>										
Main contact										
AC operated										
Closing delay (ms)	<21	<21	<21	<21	<22	<22	<22	<18	<18	<18
Opening delay (ms)	<18	<18	<18	<18	<14	<14	<14	<13	<13	<13
DC operated										
Closing delay (ms)	<31	<31	<31	<31	<47	<47	<47	<54	<54	<54
Opening delay (ms)	<12	<12	<12	<12	<30	<30	<30	<24	<24	<24
Arcing time (ms)	10	10	10	10	10	10	10	10	10	10
<b>Electromagnetic Compatibility (EMC)</b>										
Emitted interference	To EN-60947-1	To EN-60947-1	To EN-60947-1	To EN-60947-1	To EN-60947-1	To EN-60947-1	To EN-60947-1	To EN-60947-1	To EN-60947-1	To EN-60947-1
Noise immunity	To EN-60947-1	To EN-60947-1	To EN-60947-1	To EN-60947-1	To EN-60947-1	To EN-60947-1	To EN-60947-1	To EN-60947-1	To EN-60947-1	To EN-60947-1

**Notes**

① 0.7–1.3 without additional auxiliary contact modules and ambient temperature +40°C [104°F].

② Coil Suffix TD: U<sub>min</sub> 24 Vdc/U<sub>max</sub> 27 Vdc.  
 Coil Suffix WD: U<sub>min</sub> 48 Vdc/U<sub>max</sub> 60 Vdc.  
 Coil Suffix AD: U<sub>min</sub> 110 Vdc/U<sub>max</sub> 130 Vdc.  
 Coil Suffix BD: U<sub>min</sub> 200 Vdc/U<sub>max</sub> 240 Vdc.

Example:

$$U_c = 0.7 \times U_{\min} \text{—} 1.2 \times U_{\max}$$

$$U_c = 0.7 \times 24V \text{—} 1.2 \times 27 Vdc$$



## Coil Data—Frames F–G

Description	XTCE80F	XTCE95F	XTCE115G	XTCE150G	XTCE170G
<b>Voltage Tolerance</b>					
Pickup (x U <sub>c</sub> )					
AC operated	0.8–1.1	0.8–1.1	0.8–1.1	0.8–1.1	0.8–1.1
DC operated	0.7–1.2 <sup>①</sup>	0.7–1.2 <sup>①</sup>	0.7–1.2 <sup>①</sup>	0.7–1.2 <sup>①</sup>	0.7–1.2 <sup>①</sup>
Dropout (x U <sub>c</sub> )					
AC operated	0.3–0.6	0.3–0.6	0.25–0.6	0.25–0.6	0.25–0.6
DC operated	0.15–0.6	0.15–0.6	0.15–0.6	0.15–0.6	0.15–0.6
<b>Power Consumption of the Coil at Cold State and 1.0 x U<sub>c</sub></b>					
AC operated					
Single-voltage coil 50 Hz					
Pickup VA	310	310	180	180	180
Pickup W	165	165	130	130	130
Sealing VA	26	26	3.1	3.1	3.1
Sealing W	5.8	5.8	2.1	2.1	2.1
Single-voltage coil 60 Hz					
Pickup VA	345	345	170	170	170
Pickup W	190	190	130	130	130
Sealing VA	30	30	3.1	3.1	3.1
Sealing W	7.1	7.1	2.1	2.1	2.1
50/60 Hz					
Pickup VA	372	328	170	170	170
Pickup W	190	190	130	130	130
Sealing VA	37.1	22.6	3.1	3.1	3.1
Sealing W	7.5	6.1	2.1	2.1	2.1
DC operated					
Pickup W	90 at 24V	90 at 24V	149 at 24V	149 at 24V	149 at 24V
Sealing W	1.3 at 24V	1.3 at 24V	2.1 at 24V	2.1 at 24V	2.1 at 24V
Duty factor (%DF)	100	100	100	100	100
<b>Switching Time at 100% U<sub>c</sub> (Approximate Values)</b>					
Main contact					
AC operated					
Closing delay (ms)	<20	<20	<33	<33	<33
Opening delay (ms)	<14	<14	<41	<41	<41
DC operated					
Closing delay (ms)	<45	<45	<35	<35	<35
Opening delay (ms)	<34	<34	<30	<30	<30
Arcing time (ms)	15	15	15	15	15
Permissible residual current with actuation of A1–A2 by the electronics (with 0 signal) (mA)	≤1	≤1	≤1	≤1	≤1
<b>Electromagnetic Compatibility (EMC)</b>					
Emitted interference	To EN60947-1	To EN60947-1	To EN60947-1	To EN60947-1	To EN60947-1
Noise immunity	To EN60947-1	To EN60947-1	To EN60947-1	To EN60947-1	To EN60947-1

**Note**

① At 24V: 0.7–1.3 without additional auxiliary contact modules and ambient temperature +40°C [104°F].

## Coil Data—Frames H–R

Description	XTCE185H, XTCE225H	XTCE250L, XTCS250L	XTCE300L, XTCS300L	XTCE400M, XTCS400M, XTCE500M, XTCS500M, XTCE570M, XTCS570M
<b>Voltage Tolerance</b>				
Pickup ( $\times U_c$ )				
XTCE185H–XTCEC20R	$0.8 \times U_{cmin} - 1.15 \times U_{cmax}$	$0.7 \times U_{cmin} - 1.15 \times U_{cmax}$	$0.7 \times U_{cmin} - 1.15 \times U_{cmax}$	$0.7 \times U_{cmin} - 1.15 \times U_{cmax}$
XTCS250L–XTCS500M	—	$0.85 \times U_{cmin} - 1.1 \times U_{cmax}$	$0.85 \times U_{cmin} - 1.1 \times U_{cmax}$	$0.85 \times U_{cmin} - 1.1 \times U_{cmax}$
Dropout ( $\times U_c$ )				
XTCE185H–XTCEC20R	$0.2 \times U_{cmin} - 0.6 \times U_{cmax}$	$0.2 \times U_{cmin} - 0.6 \times U_{cmax}$	$0.2 \times U_{cmin} - 0.6 \times U_{cmax}$	$0.2 \times U_{cmin} - 0.6 \times U_{cmax}$
XTCS250L–XTCS500M	—	$0.2 \times U_{cmin} - 0.4 \times U_{cmax}$	$0.2 \times U_{cmin} - 0.4 \times U_{cmax}$	$0.2 \times U_{cmin} - 0.4 \times U_{cmax}$
<b>Power Consumption of the Coil at Cold State and 1.0 <math>\times U_c</math></b>				
XTCE185H–XTCEC20R				
Pickup VA	210 ①	250 ①	380 ①	450 ①
Pickup W	180	200	250	350
Sealing VA	2.6	4.3	4.3	4.3
Sealing W	2.1	3.3	3.3	3.3
XTCS250L–XTCS500M				
Pickup VA	—	360	360	715
Pickup W	—	325	625	645
Sealing VA	—	4.3	4.3	4.3
Sealing W	—	3.3	3.3	3.3
Duty factor (%DF)	—	100	100	100
<b>Switching Time at 100% Main Contact <math>U_c</math> (Approximate Values)</b>				
XTCE185H–XTCEC20R				
Closing delay (ms)	<60	<100	<80	<80
Opening delay (ms)	<40	<80	<110	<80
XTCS250L–XTCS500M				
Closing delay (ms)	—	<50	<55	<50
Opening delay (ms)	—	<40	<40	<40
<b>Reaction in Threshold and Sealing State Transition Range (XTCE185H–XTCEC20R)</b>				
Voltage interruptions				
$(0 - 0.2 \times U_{cmin}) \leq 10$ ms	Time is bridged successfully	Time is bridged successfully	Time is bridged successfully	Time is bridged successfully
$(0 - 0.2 \times U_{cmin}) > 10$ ms	Dropout of the contactor	Dropout of the contactor	Dropout of the contactor	Dropout of the contactor
Voltage dips				
$(0.2 - 0.6 \times U_{cmin}) \leq 12$ ms	Time is bridged successfully	Time is bridged successfully	Time is bridged successfully	Time is bridged successfully
$(0.2 - 0.6 \times U_{cmin}) > 12$ ms	Contactors remains switched on	Contactors remains switched on	Dropout of the contactor	Contactors remains switched on
$(0.6 - 0.7 \times U_{cmin})$	Contactors remains switched on	Contactors remains switched on	Contactors remains switched on	Contactors remains switched on
Excess voltage				
$(1.15 - 1.3 \times U_{cmax})$	Contactors remains switched on	Contactors remains switched on	Contactors remains switched on	Contactors remains switched on
$(> 1.3 \times U_{cmax}) \leq 3$ s	Contactors remains switched on	Contactors remains switched on	Contactors remains switched on	Contactors remains switched on
$(> 1.3 \times U_{cmax}) > 3$ s	Dropout of the contactor	Dropout of the contactor	Dropout of the contactor	Dropout of the contactor
Pickup phase				
$(0 - 0.7 \times U_{cmin})$	Contactors does not switch on	Contactors does not switch on	Contactors does not switch on	Contactors does not switch on
$(0.7 \times U_{cmin} - 1.15 \times U_{cmax})$	Contactors switches on with certainty	Contactors switches on with certainty	Contactors switches on with certainty	Contactors switches on with certainty
$(> 1.15 \times U_{cmax})$	Contactors switches on with certainty	Contactors switches on with certainty	Contactors switches on with certainty	Contactors switches on with certainty

**Note**① Control transformer with  $U_k \leq 6\%$ .

## Coil Data—Frames H–R, continued

Description	XTCE185H, XTCE225H	XTCE250L, XTCS250L	XTCE300L, XTCS300L	XTCE400M, XTCS400M, XTCE500M, XTCS500M, XTCE570M, XTCS570M
<b>Reaction in Threshold and Sealing State Transition Range (XTCE185H–XTCEC20R), continued</b>				
Permissible contact resistance (of the external command device with actuation of A11), ohms	—	≤500	≤500	≤500
Permissible residual current (with actuation of A11 by the electronics with 0 signal)	—	≤1	≤1	≤1
SPS signal level (A3–A4) to IEC/EN 61131-2 (Type 2)				
High	15V	15V	15V	15V
Low	5V	5V	5V	5V
Electromagnetic compatibility (EMC)	This product is designed for operation in industrial environments (environment 2). The use in residential environments (environment 1) could cause electrical interference so that addition suppression must be planned.			

## Coil Data—Frames N–R

Description	XTCE580N	XTCE750N, XTCE820N	XTCEC10N	XTCEC14P	XTCE16R, XTCEC20R
<b>Voltage Tolerance</b>					
Pickup ( $x U_c$ )					
XTCE185L–XTCEC20R	$0.7 \times U_{cmin} - 1.15 \times U_{cmax}$	$0.7 \times U_{cmin} - 1.15 \times U_{cmax}$	$0.7 \times U_{cmin} - 1.15 \times U_{cmax}$	$0.7 \times U_{cmin} - 1.15 \times U_{cmax}$	$0.7 \times U_{cmin} - 1.15 \times U_{cmax}$
XTCS185L–XTCS500M	$0.85 \times U_{cmin} - 1.1 \times U_{cmax}$	$0.85 \times U_{cmin} - 1.1 \times U_{cmax}$	$0.85 \times U_{cmin} - 1.1 \times U_{cmax}$	$0.85 \times U_{cmin} - 1.1 \times U_{cmax}$	$0.85 \times U_{cmin} - 1.1 \times U_{cmax}$
Dropout ( $x U_c$ )					
XTCE185L–XTCEC20R	$0.2 \times U_{cmin} - 0.6 \times U_{cmax}$	$0.2 \times U_{cmin} - 0.6 \times U_{cmax}$	$0.2 \times U_{cmin} - 0.6 \times U_{cmax}$	$0.2 \times U_{cmin} - 0.6 \times U_{cmax}$	$0.2 \times U_{cmin} - 0.6 \times U_{cmax}$
XTCS185L–XTCS500M	$0.2 \times U_{cmin} - 0.4 \times U_{cmax}$	$0.2 \times U_{cmin} - 0.4 \times U_{cmax}$	$0.2 \times U_{cmin} - 0.4 \times U_{cmax}$	$0.2 \times U_{cmin} - 0.4 \times U_{cmax}$	$0.2 \times U_{cmin} - 0.4 \times U_{cmax}$
<b>Power Consumption of the Coil at Cold State and <math>1.0 \times U_c</math></b>					
XTCE185L–XTCEC20R					
Pickup VA	800 <sup>①</sup>	800 <sup>①</sup>	800 <sup>①</sup>	800 <sup>①</sup>	1600 <sup>①</sup>
Pickup W	700	700	700	700	1400
Sealing VA	7.5	7.5	7.5	7.5	15
Sealing W	6.5	6.5	6.5	6.5	13
XTCS185L–XTCS500M					
Pickup VA	—	—	—	—	—
Pickup W	—	—	—	—	—
Sealing VA	—	—	—	—	—
Sealing W	—	—	—	—	—
Duty factor (%DF)	100	100	100	100	100
<b>Switching Time at 100% Main Contact <math>U_c</math> (Approximate Values)</b>					
XTCE185L–XTCEC20R					
Closing delay (ms)	<70	<70	<70	<70	<70
Opening delay (ms)	<70	<70	<70	<40	<40
XTCS185L–XTCS500M					
Closing delay (ms)	—	—	—	—	—
Opening delay (ms)	—	—	—	—	—

**Note**

<sup>①</sup> Control transformer with  $U_k \leq 7\%$ .

## Coil Data—Frames N–R, continued

Description	XTCE580N	XTCE750N, XTCE820N	XTCEC10N	XTCEC14P	XTCE16R, XTCEC20R
<b>Reaction in Threshold and Sealing State Transition Range (XTCE185L–XTCEC20R)</b>					
Voltage interruptions					
$(0-0.2 \times U_{cmin}) \leq 10$ ms	Time is bridged successfully	Time is bridged successfully	Time is bridged successfully	Time is bridged successfully	Time is bridged successfully
$(0-0.2 \times U_{cmin}) > 10$ ms	Dropout of the contactor	Dropout of the contactor	Dropout of the contactor	Dropout of the contactor	Dropout of the contactor
Voltage dips					
$(0.2-0.6 \times U_{cmin}) \leq 12$ ms	Time is bridged successfully	Time is bridged successfully	Time is bridged successfully	Time is bridged successfully	Time is bridged successfully
$(0.2-0.6 \times U_{cmin}) > 12$ ms	Dropout of the contactor	Dropout of the contactor	Dropout of the contactor	Dropout of the contactor	Dropout of the contactor
$(0.6-0.7 \times U_{cmin})$	Contactor remains switched on	Contactor remains switched on	Contactor remains switched on	Contactor remains switched on	Contactor remains switched on
Excess voltage					
$(1.15-1.3 \times U_{cmax})$	Contactor remains switched on	Contactor remains switched on	Contactor remains switched on	Contactor remains switched on	Contactor remains switched on
$(>1.3 \times U_{cmax}) \leq 3$ s	Contactor remains switched on	Contactor remains switched on	Contactor remains switched on	Contactor remains switched on	Contactor remains switched on
$(>1.3 \times U_{cmax}) > 3$ s	Dropout of the contactor	Dropout of the contactor	Dropout of the contactor	Dropout of the contactor	Dropout of the contactor
Pickup phase					
$(0-0.7 \times U_{cmin})$	Contactor does not switch on	Contactor does not switch on	Contactor does not switch on	Contactor does not switch on	Contactor does not switch on
$(0.7 \times U_{cmin} - 1.15 \times U_{cmax})$	Contactor switches on with certainty	Contactor switches on with certainty	Contactor switches on with certainty	Contactor switches on with certainty	Contactor switches on with certainty
$(>1.15 \times U_{cmax})$	Contactor switches on with certainty	Contactor switches on with certainty	Contactor switches on with certainty	Contactor switches on with certainty	Contactor switches on with certainty
Permissible contact resistance (of the external command device with actuation of A11), ohms	$\leq 500$	$\leq 500$	$\leq 500$	$\leq 500$	$\leq 500$
Permissible residual current (with actuation of A11 by the electronics with 0 signal)	$\leq 1$	$\leq 1$	$\leq 1$	$\leq 1$	$\leq 1$
SPS signal level (A3–A4) to IEC/EN 61131-2 (Type 2)					
High	15V	15V	15V	15V	15V
Low	5V	5V	5V	5V	5V
Electromagnetic compatibility (EMC)	①	①	①	①	①

**Note**

- ① This product is designed for operation in industrial environments. Usage in domestic areas can cause radio frequency interference (RFI). Noise suppression measures must be provided for the additional interference.

## XT Contactors—Four-Pole

Description	XTCF020B	XTCF032C	XTCF045C	XTCF063D	XTCF080D	XTCF125G	XTCF160G	XTCF200G
<b>General</b>								
Standards	IEC/EN 60947, VDE 0660, UL, CSA	IEC/EN 60947, VDE 0660, UL, CSA	IEC/EN 60947, VDE 0660, UL, CSA	IEC/EN 60947, VDE 0660, UL, CSA	IEC/EN 60947, VDE 0660, UL, CSA	IEC/EN 60947, VDE 0660, UL, CSA	IEC/EN 60947, VDE 0660, UL, CSA	IEC/EN 60947, VDE 0660, UL, CSA
Weights in kg [lb]								
AC operated	0.22 [0.49]	0.49 [1.1]	0.49 [1.1]	1.0 [2.3]	1.0 [2.3]	2.8 [6.2]	2.8 [6.2]	2.8 [6.2]
DC operated	0.29 [0.64]	0.49 [1.1]	0.49 [1.1]	1.0 [2.3]	1.0 [2.3]	2.8 [6.2]	2.8 [6.2]	2.8 [6.2]
Mechanical life—operations	10,000,000	10,000,000	10,000,000	10,000,000	10,000,000	10,000,000	10,000,000	10,000,000
Mechanical operating frequency (ops/hr)								
AC operated	5000	5000	5000	5000	5000	3600	3600	3600
DC operated	5000	5000	5000	5000	5000	3600	3600	3600
Electrical life	See Curves, Page V5-T1-111	See Curves, Page V5-T1-111	See Curves, Page V5-T1-111	See Curves, Page V5-T1-111	See Curves, Page V5-T1-111	See Curves, Page V5-T1-111	See Curves, Page V5-T1-111	See Curves, Page V5-T1-111
Electrical operating frequency (ops/hr)	600	600	600	600	600	600	600	600
Climatic proofing								
	①	①	①	①	①	①	①	①
	②	②	②	②	②	②	②	②
Insulation voltage (U <sub>i</sub> ) Vac	690	690	690	690	690	690	690	690
Impulse withstand voltage (U <sub>imp</sub> ) Vac	8000	8000	8000	8000	8000	8000	8000	8000
Operation voltage (U <sub>e</sub> ) Vac	690	690	690	690	690	690	690	690
Safe isolation to VDE 0106 Part 101 and Part 101/A1								
Between coil and contacts (Vac)	400	440	440	440	440	440	440	440
Between contacts (Vac)	400	440	440	440	440	440	440	440
Making capacity up to 690V (amps)	144	238	350	560	700	1120	1330	1800
Breaking capacity (amps)								
220/230V	120	180	250	00	00	800	950	1150
380/400V	120	180	250	400	500	800	950	1150
500V	100	180	250	400	500	800	950	1150
660/690V	70	120	144	250	296	650	750	800
Short-circuit protection rating maximum fuse								
Type 2 coordination								
400V; gG/gL 500V	20	35	35	63	80	160	160	250
690V; gG/gL 690V	2	35	35	50	63	160	160	200
Type 1 coordination								
400V; gG/gL 500V	35	6	100	125	160	250	250	250
690V; gG/gL 690V	25	50	50	80	80	200	200	200
Degree of protection with accessories								
	IP20	IP00	IP00	IP00	IP00	IP00	IP00	IP00
	—	—	—	IP20	IP20	IP20	IP20	IP20
Protection against direct contact when actuated from front (IEC 536)								
	Finger and back-of-hand proof	Finger and back-of-hand proof	Finger and back-of-hand proof	Finger and back-of-hand proof	Finger and back-of-hand proof	Finger and back-of-hand proof	Finger and back-of-hand proof	Finger and back-of-hand proof

**Notes**

- ① Damp heat, constant, to IEC 60068-2-3.  
 ② Damp heat, cyclical, to IEC 60068-2-30.

#### XT Contactors—Four-Pole, continued

Description	XTCF020B	XTCF032C	XTCF045C	XTCF063D	XTCF080D	XTCF125G	XTCF160G	XTCF200G
<b>General, continued</b>								
Terminal capacity main cable—screw terminals								
Solid (mm <sup>2</sup> )	1 x (0.75–4) 2 x (0.75–2.5)	1 x (0.75–16) 2 x (0.75–10)	1 x (0.75–16) 2 x (0.75–10)	1 x (2.5–16) 2 x (2.5–16)	1 x (2.5–16) 2 x (2.5–16)	—	—	—
Flexible with ferrule (mm <sup>2</sup> )	1 x (0.75–2.5) 2 x (0.75–2.5)	1 x (0.75–16) 2 x (0.75–10)	1 x (0.75–16) 2 x (0.75–10)	1 x (2.5–35) 2 x (2.5–25)	1 x (2.5–35) 2 x (2.5–25)	1 x (10–95) 2 x (10–70)	1 x (10–95) 2 x (10–70)	1 x (10–95) 2 x (10–70)
Solid or stranded (AWG)	18–14	18–6	18–6	12–2	12–2	8–250 kcmil	8–250 kcmil	8–250 kcmil
Terminal capacity control circuit cable—screw terminals								
Solid (mm <sup>2</sup> )	1 x (0.75–4) 2 x (0.75–2.5)	1 x (0.75–4) 2 x (0.75–2.5)	1 x (0.75–4) 2 x (0.75–2.5)	1 x (0.75–4) 2 x (0.75–2.5)	1 x (0.75–4) 2 x (0.75–2.5)	1 x (0.75–4) 2 x (0.75–2.5)	1 x (0.75–4) 2 x (0.75–2.5)	1 x (0.75–4) 2 x (0.75–2.5)
Flexible with ferrule (mm <sup>2</sup> )	1 x (0.75–2.5) 2 x (0.75–2.5)	1 x (0.75–2.5) 2 x (0.75–2.5)	1 x (0.75–2.5) 2 x (0.75–2.5)	1 x (0.75–2.5) 2 x (0.75–2.5)	1 x (0.75–2.5) 2 x (0.75–2.5)	1 x (0.75–2.5) 2 x (0.75–2.5)	1 x (0.75–2.5) 2 x (0.75–2.5)	1 x (0.75–2.5) 2 x (0.75–2.5)
Solid or stranded (AWG)	18–14	18–14	18–14	18–14	18–14	18–14	18–14	18–14
Main cable connection screw/bolt								
Tightening torque								
Nm	1.2	3	3	3.3	3.3	14	14	14
Lb-in	10.6	26.6	26.6	29.2	29.2	123.9	123.9	123.9
Control circuit cable connection screw/bolt								
Tightening torque								
Nm	1.2	1.2	1.2	1.2	1.2	1.2	1.2	1.2
Lb-in	10.6	10.6	10.6	10.6	10.6	10.6	10.6	10.6
Tools								
Main and control circuit cable—								
Screw terminals	2	2	2	2	2	—	—	—
Pozidriv screwdriver	0.8 x 5.5	0.8 x 5.5	0.8 x 5.5	0.8 x 5.5	0.8 x 5.5	—	—	—
Standard screwdriver	1 x 6	1 x 6	1 x 6	1 x 6	1 x 6	—	—	—
Mounting position, AC and DC operated								
Ambient temperature								
Open	–25 to 60°C (–13 to 140°F)	–25 to 60°C (–13 to 140°F)	–25 to 60°C (–13 to 140°F)	–25 to 60°C (–13 to 140°F)	–25 to 60°C (–13 to 140°F)	–25 to 60°C (–13 to 140°F)	–25 to 60°C (–13 to 140°F)	–25 to 60°C (–13 to 140°F)
Enclosed	–25 to 40°C (–13 to 104°F)	–25 to 40°C (–13 to 104°F)	–25 to 40°C (–13 to 104°F)	–25 to 40°C (–13 to 104°F)	–25 to 40°C (–13 to 104°F)	–25 to 40°C (–13 to 104°F)	–25 to 40°C (–13 to 104°F)	–25 to 40°C (–13 to 104°F)
Ambient storage temperature	–40 to 80°C (–40 to 176°F)	–40 to 80°C (–40 to 176°F)	–40 to 80°C (–40 to 176°F)	–40 to 80°C (–40 to 176°F)	–40 to 80°C (–40 to 176°F)	–40 to 80°C (–40 to 176°F)	–40 to 80°C (–40 to 176°F)	–40 to 80°C (–40 to 176°F)

**XT Contactors—Four-Pole, continued**

Description	XTCF020B	XTCF032C	XTCF045C	XTCF063D	XTCF080D	XTCF125G	XTCF160G	XTCF200G
<b>Environmental</b>								
Mechanical shock resistance (IEC/EN 60068-2-27)								
Half-sinusoidal shock 10 ms								
Main contact—NO contact	10g	10g	10g	10g	10g	10g	10g	10g
Auxiliary contact—NO contact	7g	7g	7g	7g	7g	7g	7g	7g
Auxiliary contact—NC contact	5g	5g	5g	5g	5g	5g	5g	5g
Overvoltage category/pollution degree	III/3	III/3	III/3	III/3	III/3	III/3	III/3	III/3
<b>Coil Data Voltage Tolerance</b>								
Pickup (x U <sub>c</sub> )								
AC operated	0.8–1.1	0.8–1.1	0.8–1.1	0.8–1.1	0.8–1.1	0.8–1.1	0.8–1.1	0.8–1.1
DC operated	0.8–1.1	0.7–1.2	0.7–1.2	0.7–1.2	0.7–1.2	0.7–1.2	0.7–1.2	0.7–1.2
Dropout (x U <sub>c</sub> )								
AC operated	0.4–0.6	0.4–0.6	0.4–0.6	0.4–0.6	0.4–0.6	0.4–0.6	0.4–0.6	0.4–0.6
DC operated	0.2–0.6	0.2–0.6	0.2–0.6	0.2–0.6	0.2–0.6	0.2–0.6	0.2–0.6	0.2–0.6
<b>Power Consumption of the Coil at Cold State and 1.0 x U<sub>c</sub></b>								
AC operated 50/50Hz								
Pickup VA	24	50	50	150	150	180	180	180
Pickup W	19	40	40	95	95	150	150	150
Sealing VA	4	8	8	16	16	3.1	3.1	3.1
Sealing W	1.2	2.4	2.4	4	4	2.1	2.1	2.1
DC operated								
Pickup W	4.5	12	12	24	24	149	149	149
Sealing W	4.5	0.5	0.5	0.5	0.5	2.1	2.1	2.1
Duty factor (%DF)	100	100	100	100	100	100	100	100
<b>Switching Time at 100% U<sub>c</sub> (Approximate Values)</b>								
Main contact								
AC operated								
Closing delay (ms)	15 to 21	6 to 22	6 to 22	12 to 18	12 to 18	28 to 33	28 to 33	28 to 33
Opening delay (ms)	9 to 18	8 to 14	8 to 14	8 to 13	8 to 13	35 to 41	35 to 41	35 to 41
DC operated								
Closing delay (ms)	31	47	47	54	54	35	35	35
Opening delay (ms)	12	30	30	24	24	30	30	30
Arcing time (ms)	10	10	10	10	10	15	15	15

## Auxiliary Contacts

Description	XTCE007B_ XTCE032C	XTCEXFAC_ XTCEXFATC_	XTCEXFCC_ XTCEXSCC_	XTCEXFAG_	XTCEXSBLN_ XTCEXSBN_ XTCEXSBN_ XTCEXSBN_ XTCEXSBN_ XTCEXSBN_
					XTCEXSBN_ XTCEXSBN_ XTCEXSBN_ XTCEXSBN_ XTCEXSBN_
Interlocked opposing contacts with an auxiliary contact module (to IEC 60947-5 -1 Annex L)	—	Yes	Yes	Yes	Yes
Break contact (not late-break contact) suitable as a mirror contact (to IEC/EN 60947-4 -1 Annex F)	XTCE007B_ XTCE032C	XTCE007B_ XTCE032C	XTCE007B_ XTCE032C	XTCE040D_ XTCE065D_	XTCE040D_ XTCE065D_ XTCE185L_ XTCEC10N_
Rated impulse withstand voltage, ( $U_{imp}$ ) Vac	6000	6000	6000	6000	6000
Overvoltage category/pollution degree	III/3	III/3	III/3	III/3	III/3
Rated insulation voltage, ( $U_i$ ) Vac	690	690	690	690	690
Rated operational voltage, ( $U_e$ ) Vac	500	500	500	500	500
Safe isolation to VDE 0106 Part 101 and Part 101(A) in Vac					
Between coil and auxiliary contacts	400	400	400	440	440
Between the auxiliary contacts	400	400	400	440	440
Rated operational current, $I_e$					
AC-15					
230V	6A	6A	6A	6A	6A
380/415V	4A	3A	4A	4A	4A
500V	1.5A	—	1.5A	1.5A	1.5A
DC-3 L/R $\leq 5$ ms <sup>①</sup>					
24V	10A	10A	10A	10A	10A
60V	6A	6A	6A	6A	6A
110V	3A	3A	3A	3A	3A
220V	1A	1A	1A	1A	1A
Conventional thermal current, $I_{th}$	16A	16A	16A <sup>③</sup>	10A	10A
Control circuit reliability (at $U_e = 24$ Vdc, $U_{min} = 17$ V, $I_{min} = 5.4$ mA)	$<10^{-8}$ , <1 failure at 100 million operations	$<10^{-8}$ , <1 failure at 100 million operations	$<10^{-8}$ , <1 failure at 100 million operations	$<10^{-8}$ , <1 failure at 100 million operations	$<10^{-8}$ , <1 failure at 100 million operations
Component lifespan, operations x $10^6$ at $U_e = 230$ V, AC-15, 3A	1.3	1.3	1.3	1.3	1.3
Short-circuit rating without welding <sup>②</sup>					
Maximum fuse, gG/gL	10A	10A	10A	16A	16A

**Notes**

- ① Making and breaking conditions to DC-13, time L/R contact as stated.  
 ② See fuses overlay for time/current characteristic (on request).  
 ③ Conventional thermal current ( $I_{th}$ ) of XTCEXSCC\_ is 10A.



**Parallel Link**

Description	XTCEXPLKB	XTECXPLKC	XTCEXPLKD	XTCEXPLKG	XTCEXPLK185
Terminal capacity					
Solid (mm <sup>2</sup> )	1–16	16	16	—	—
Flexible with ferrule (mm <sup>2</sup> )	1 x (0.5–25) 2 x (0.5–16)	1 x (16–35)	1 x (16–120)	—	—
Stranded (mm <sup>2</sup> )	1 x (0.5–25) 2 x (0.5–16)	1 x (16–50)	1 x (16–120)	1 x (35–300) 2 x (35–120)	—
Flat conductor—number of segments x width x thickness (mm)	6 x 9 x 0.8	—	—	2 x (11 x 21 x 1)	1 x (6 x 16 x 0.8) 2 x (20 x 32 x 0.5) 2 x (11 x 21 x 1)
Tightening torque (Nm)	4	4	14	—	—
Tools					
Pozidriv screwdriver	Size 2	Size 2	—	—	—
Hexagon socket head spanner—SW (mm)	—	—	5	6	—
Conventional thermal current					
Three-pole (I <sub>th</sub> ) A	50	100	180	400	—
Four-pole (I <sub>th</sub> ) A	60	—	—	—	—

**Cable Terminal Block, Flat Cable Terminal**

Description	XTCEXTLA225A	XTCEXTLA400	XTCEXPLK185	XTCEXTFB650	XTCEXTFB820
Terminal capacity					
Stranded (mm <sup>2</sup> )	1 x (16–185) 2 x (16–150)	1 x (120–300) 2 x (70–240)	—	—	—
Stranded (AWG)	1 x (6–350 kcmil) 2 x (6–350 kcmil)	1 x (250–600 kcmil) 2 x (2/0–500 kcmil)	—	—	—
Flat conductor—number of segments x width x thickness (mm)	—	—	1 x (6 x 16 x 0.8) 2 x (20 x 32 x 0.5) 2 x (11 x 21 x 1)	1 x (6 x 16 x 0.8) 2 x (20 x 32 x 0.5) 2 x (11 x 21 x 1)	1 x (6 x 16 x 0.8) 2 x (10 x 40 x 1) 2 x (20 x 40 x 0.5)

**AC Ratings—AC-1 Operation**

Description	XTCE007B	XTCE009B	XTCE012B	XTCE015B	XTCE018C	XTCE025C	XTCE032C
Conventional free air thermal current, three-pole, 50–60 Hz							
Open							
at 40°C (I <sub>th</sub> )	22A	22A	22A	22A	40A	45A	45A
at 50°C (I <sub>th</sub> )	21A	21A	21A	21A	38A	43A	43A
at 55°C (I <sub>th</sub> )	21A	21A	21A	21A	37A	42A	42A
at 60°C (I <sub>th</sub> )	20A	20A	20A	20A	35A	40A	40A
Enclosed	18A	18A	18A	18A	32A	36A	36A
Conventional free air thermal current, single-pole (I <sub>th</sub> )							
Open	50A	50A	50A	50A	88A	100A	100A
Enclosed	45A	45A	45A	45A	80A	90A	90A

## AC Ratings—AC-3 Operation

Description	XTCE007B	XTCE009B	XTCE012B	XTCE015B	XTCE018C	XTCE025C	XTCE032C
Rated operational current, 50/60 Hz <sup>①</sup> (I <sub>g</sub> ) in amperes							
220/230V	7	9	12	15.5	18	25	32
240V	7	9	12	15.5	18	25	32
380/400V	7	9	12	15.5	18	25	32
415V	7	9	12	15.5	18	25	32
440V	7	9	12	15.5	18	25	32
500V	5	7	10	12.5	18	25	32
660/690V	4	5	7	9	12	15	18
1000V	—	—	—	—	—	—	—
Rated power (P) in kilowatts							
220/230V	2.2	2.5	3.5	4	5	7.5	10
240V	2.2	3	4	4.6	5.5	8.5	11
380/400V	3	4	5.5	7.5	7.5	11	15
415V	4	5.5	7	8	10	14.5	19
440V	4.5	5.5	7.5	8.4	10.5	15.5	20
500V	3.5	4.5	7	7.5	12	17.5	23
660/690V	3.5	4.5	6.5	7	11	14	17
1000V	—	—	—	—	—	—	—

## AC Ratings—AC-4 Operation

Description	XTCE007B	XTCE009B	XTCE012B	XTCE015B	XTCE018C	XTCE025C	XTCE032C
Rated operational current, 50/60 Hz <sup>②</sup> (I <sub>g</sub> ) in amperes							
220/230V	5	6	7	7	10	13	15
240V	5	6	7	7	10	13	15
380/400V	5	6	7	7	10	13	15
415V	5	6	7	7	10	13	15
440V	5	6	7	7	10	13	15
500V	4.5	5	6	6	1	13	1
660/690V	4	4.5	5	5	8	10	12
1000V	—	—	—	—	—	—	—
Rated power (P) in kilowatts							
220/230V	1	1.5	2	2	2.5	3.5	4
240V	1.5	1.6	2.2	2.2	3	4	4.5
380/400V	2.2	2.5	3	3	4.5	6	7
415V	2.3	2.8	3.4	3.4	5	6.5	7.5
440V	2.4	3	3.6	3.6	5.5	7	8
500V	2.5	2.8	3.5	3.5	6	8	9
660/690V	2.9	3.6	4.4	4.4	6.5	8.5	10
1000V	—	—	—	—	—	—	—

**Notes**

① At maximum permissible ambient temperature.

② Example—

The transformer has a nominal current of 10A with an inrush current of 18 times the nominal current. So, the contactor must have an AC-3 current of  $18/6 \times 10A = 30A$ . Using an XTCE032C (32A AC-3) contactor is recommended.

**AC Ratings—AC-6A Operation**

Description	XTCE007B	XTCE009B	XTCE012B	XTCE015B	XTCE018C	XTCE025C	XTCE032C
Transformer loads	Values are application specific	Values are application specific	Values are application specific	Values are application specific	Values are application specific	Values are application specific	Values are application specific
Calculation is $I_g \text{ AC-3} = X / 6 * I_g$ transformer where X is the inrush current of the transformer and $I_g$ transformer is the nominal current. <sup>①</sup>							

**AC Ratings—AC-6B Operation**

Description	XTCE007B	XTCE009B	XTCE012B	XTCE015B	XTCE018C	XTCE025C	XTCE032C
Capacitor loads							
Individual compensation rated operational current $I_g$ of three-phase capacitors in amperes							
Up to 525V							See Page V5-T1-63 for capacitor ratings
690V							See Page V5-T1-63 for capacitor ratings
Maximum inrush current peak (x $I_g$ )	30	30	30	30	30	30	30
Component lifesaving (operations)	—	—	—	—	—	—	—
Maximum operating frequency (ops/hr)	—	—	—	—	—	—	—

**AC Ratings—AC-1 Operation**

Description	XTCE040D	XTCE050D	XTCE065D	XTCE072D	XTCE080F	XTCE095F	XTCE115G	XTCE150G	XTCE170G
Conventional free air thermal current, three-pole, 50–60 Hz									
Open									
at 40°C ( $I_{th}$ )	60A	80A	98A	98A	110A	130A	160A	190A	275A <sup>②</sup>
at 50°C ( $I_{th}$ )	57A	71A	88A	88A	98A	125A	142A	180A	200A
at 55°C ( $I_{th}$ )	55A	68A	83A	83A	94A	115A	135A	170A	190A
at 60°C ( $I_{th}$ )	50A	65A	80A	80A	90A	110A	130A	160A	185A
Enclosed	45A	58A	72A	72A	80A	100A	115A	144A	166A
Conventional free air thermal current, single-pole ( $I_{th}$ )									
Open	125A	162A	200A	200A	225A	275A	325A	400A	460A
Enclosed	112A	145A	180A	180A	200A	250A	285A	360A	415A

**Notes**

- <sup>①</sup> Example—  
The transformer has a nominal current of 10A with an inrush current of 18 times the nominal current. So, the contactor must have an AC-3 current of  $18/6 \times 10A = 30A$ . Using an XTCE032C (32A AC-3) contactor is recommended.
- <sup>②</sup> For 225–275A, use 2X 70 mm<sup>2</sup> wire.
- <sup>③</sup> At maximum permissible ambient temperature.

## AC Ratings—AC-3 Operation

Description	XTCE040D	XTCE050D	XTCE065D	XTCE072D	XTCE080F	XTCE095F	XTCE115G	XTCE150G	XTCE170G
Rated operational current, 50/60 Hz <sup>①</sup> (I <sub>g</sub> ) in amperes									
220/230V	40	50	65	72	80	95	115	150	170
240V	40	50	65	72	80	95	115	150	170
380/400V	40	50	65	7	80	95	115	150	170
415V	40	50	65	72	80	95	115	150	170
440V	40	50	65	72	80	95	115	15	170
500V	40	50	65	72	80	95	115	150	170
660/690	25	32	37	37	65	80	93	100	150
1000V	—	—	—	—	—	—	—	—	—
Rated power (P) in kilowatts									
220/230V	12.5	15.5	20	22	25	30	37	48	52
240V	13.5	17	22	35	27.5	34	40	52	57
380/400V	18.5	22	30	37	37	45	55	75	90
415V	24	30	39	41	43	57	70	91	100
440V	25	32	41	44	51	60	75	95	105
500V	28	36	47	45	58	70	85	110	120
660/690V	23	30	35	35	63	75	90	96	140
1000V	—	—	—	—	—	—	—	—	—

## AC Ratings—AC-4 Operation

Description	XTCE040D	XTCE050D	XTCE065D	XTCE072D	XTCE080F	XTCE095F	XTCE115G	XTCE150G	XTCE170G
Rated operational current, 50/60 Hz <sup>①</sup> (I <sub>g</sub> ) in amperes									
220/230V	18	21	25	25	40	50	55	65	65
240V	18	21	25	25	40	50	55	65	65
380/400V	18	21	25	25	40	50	55	65	65
415V	18	21	25	25	40	50	55	65	65
440V	18	21	25	25	40	50	55	65	65
500V	18	21	25	25	40	50	55	65	65
660/690V	14	17	20	20	40	50	45	50	50
1000V	—	—	—	—	—	—	—	—	—
Rated power (P) in kilowatts									
220/230V	5	6	7	7	12	16	17	20	20
240V	5.5	6.5	7.5	7.5	13	17	19	22	22
380/400V	9	10	12	12	20	26	28	33	33
415V	9.5	11	13	13	24	30	33	39	39
440V	10	12	14	14	25	32	35	41	41
500V	11	13	16	16	29	36	40	47	47
660/690V	12	14	17	17	26	35	43	48	48
1000V	—	—	—	—	—	—	—	—	—

**Note**

<sup>①</sup> At maximum permissible ambient temperature.

**AC Ratings—AC-6-A Operation**

Description	XTCE040D	XTCE050D	XTCE065D	XTCE072D	XTCE080F	XTCE095F	XTCE115G	XTCE150G	XTCE170G
Transformer loads	Values are application specific	Values are application specific	Values are application specific	Values are application specific	Values are application specific	Values are application specific	Values are application specific	Values are application specific	Values are application specific

Calculation is  $I_g \text{ AC-3} = X / 6 * I_g$  transformer where X is the inrush current of the transformer and  $I_g$  transformer is the nominal current. <sup>①</sup>

**AC Ratings—AC-6-B Operation**

Description	XTCE040D	XTCE050D	XTCE065D	XTCE072D	XTCE080F	XTCE095F	XTCE115G	XTCE150G	XTCE170G
Capacitor loads									
Individual compensation rated operational current $I_g$ of three-phase capacitors in amperes									
Up to 525V									
690V									
Maximum inrush current peak (x $I_g$ )	30	30	30	30	30	30	30	30	30
Component lifesaving (operations)	—	—	—	—	—	—	—	—	—
Maximum operating frequency (ops/hr)	—	—	—	—	—	—	—	—	—

See **Page V5-T1-63** for capacitor ratings

See **Page V5-T1-63** for capacitor ratings

**AC Ratings—AC-1 Operation**

Description	XTCE185H	XTCE225L	XTCE250L	XTCE300L	XTCE400M	XTCE500M	XTCE570M	XTCE580N
Conventional free air thermal current, three-pole, 50–60 Hz								
at 40°C ( $I_{th}$ )	337	356	429	490	612	857	857	980
at 50°C ( $I_{th}$ )	301	310	383	438	548	767	767	876
at 55°C ( $I_{th}$ )	287	295	366	418	522	731	731	836
at 60°C ( $I_{th}$ )	275	285	350	400	500	700	700	800
Conventional free air thermal current, single-pole ( $I_{th}$ )	245	275	875	315	1250	1750	1750	2000

**Note**

<sup>①</sup> Example—The transformer has a nominal current of 10A with an inrush current of 18 times the nominal current. So, the contactor must have an AC-3 current of  $18/6 \times 10A = 30A$ . Using an XTCE032C (32A AC-3) contactor is recommended.

## AC Ratings—AC-3 Operation

Description	XTCE185H	XTCE225L	XTCE250L	XTCE300L	XTCE400M	XTCE500M	XTCE570M	XTCE580N
Rated operational current, 50/60 Hz <sup>①</sup> (I <sub>g</sub> ) in amperes								
220/230V	185	225	250	300	400	500	580	580
240V	185	225	250	300	400	500	580	580
380/400V	185	225	250	300	400	500	580	580
415V	185	225	250	300	400	500	580	580
440V	185	225	250	300	400	500	580	580
500V	185	225	250	300	400	500	580	580
660/690V	150	160	250	210	400	500	580	580
1000V	76	76	76	95	95	95	95	435
Rated power (P) in kilowatts								
220/230V	55	70	75	90	125	155	185	185
240V	62	75	85	100	132	170	200	200
380/400V	90	110	132	160	200	250	315	315
415V	110	132	148	180	240	300	348	348
440V	115	138	157	185	255	345	370	370
500V	132	160	180	215	290	360	420	420
660/690V	140	150	240	195	344	344	344	560
1000V	108	108	108	132	132	132	132	600

## AC Ratings—AC-4 Operation

Description	XTCE185H	XTCE225L	XTCE250L	XTCE300L	XTCE400M	XTCE500M	XTCE570M	XTCE580N
Rated operational current, 50/60 Hz <sup>①</sup> (I <sub>g</sub> ) in amperes								
220/230V	136	164	200	200	296	360	360	456
240V	136	164	200	200	296	360	360	456
380/400V	136	164	200	200	296	360	360	456
415V	136	164	200	200	296	360	360	456
440V	136	164	200	200	296	360	360	456
500V	136	164	200	200	296	360	360	456
660/690V	110	120	200	200	296	360	360	456
1000V	55	55	76	76	95	95	95	348
Rated power (P) in kilowatts								
220/230V	41	51	62	75	92	112	112	143
240V	45	54	68	82	101	122	122	156
380/400V	75	90	110	132	160	200	200	250
415V	80	96	117	142	176	216	216	274
440V	85	102	125	150	186	229	229	290
500V	96	116	143	172	214	260	260	330
660/690V	102	110	189	160	283	344	344	440
1000V	77	77	108	109	132	132	132	509

**Note**

<sup>①</sup> At maximum permissible ambient temperature.

**AC Ratings—AC-1 Operation**

Description	XTCE650N	XTCE750N	XTCE820N	XTCEC10N	XTCEC14P	XTCEC16R	XTCEC20R
Conventional free air thermal current, three-pole, 50–60 Hz							
at 40°C ( $I_{th}$ )	1041	1102	1225	1225	1714 ①	2200	2450 ①
at 50°C ( $I_{th}$ )	931	986	1095	1095	1533 ①	1970	2190 ①
at 55°C ( $I_{th}$ )	888	940	1044	1044	1462 ①	1800	2089 ①
at 60°C ( $I_{th}$ )	850	900	1000	1000	1400 ①	1800	2000 ①
Conventional free air thermal current, single-pole ( $I_{th}$ )	2125	2250	2500	2500	3500	4500	5000

**AC Ratings—AC-3 Operation**

Description	XTCE650N	XTCE750N	XTCE820N	XTCEC10N	XTCEC14P	XTCEC16R	XTCEC20R
Rated operational current, 50/60 Hz ② ( $I_b$ ) in amperes							
220/230V	650	750	820	1000	—	1600	—
240V	650	750	820	1000	—	1600	—
380/400V	650	750	820	1000	—	1600	—
415V	650	750	820	1000	—	1600	—
440V	650	750	820	1000	—	1600	—
500V	650	750	820	1000	—	1600	—
660/690V	650	750	820	1000	—	1600	—
1000V	435	580	580	700	—	—	—
Rated power (P) in kilowatts							
220/230V	205	240	260	315	—	500	—
240V	225	260	285	340	—	550	—
380/400V	355	400	450	560	—	900	—
415V	390	455	500	610	—	930	—
440V	420	480	525	650	—	1000	—
500V	470	550	600	730	—	1180	—
660/690V	630	720	750	1000	—	1600	—
1000V	600	800	800	1000	—	—	—

**Notes**

① Up to 690V.

② At maximum permissible ambient temperature.

## AC Ratings—AC-4 Operation

Description	XTCE650N	XTCE750N	XTCE820N	XTCEC10N	XTCEC14P	XTCEC16R	XTCEC20R
Rated operational current, 50/60 Hz <sup>①</sup> (I <sub>0</sub> ) in amperes							
220/230V	512	576	656	800	—	1280	—
240V	512	576	656	800	—	1280	—
380/400V	512	576	656	800	—	1280	—
415V	512	576	656	800	—	1280	—
440V	512	576	656	800	—	1280	—
500V	512	576	656	800	—	1280	—
660/690V	512	576	656	800	—	1280	—
1000V	348	464	464	700	—	—	—
Rated power (P) in kilowatts							
220/230V	161	181	209	260	—	30	—
240V	176	200	228	280	—	450	—
380/400V	280	315	355	450	—	750	—
415V	307	346	394	490	—	770	—
440V	32	367	41	520	—	830	—
500V	370	417	474	590	—	940	—
660/690V	494	556	633	780	—	1300	—
1000V	509	678	678	1000	—	—	—

## AC Ratings—AC-6A Operation

Description	XTCE650N	XTCE750N	XTCE820N	XTCEC10N	XTCEC14P	XTCEC16R	XTCEC20R
Transformer loads	Values are application specific	Values are application specific	Values are application specific	Values are application specific	Values are application specific	Values are application specific	Values are application specific
Calculation is I <sub>0</sub> AC-3 = X / 6 * I <sub>0</sub> transformer where X is the inrush current of the transformer and I <sub>0</sub> transformer is the nominal current. <sup>②</sup>							

## Notes

<sup>①</sup> At maximum permissible ambient temperature.

<sup>②</sup> Example—The transformer has a nominal current of 10A with an inrush current of 18 times the nominal current. So, the contactor must have an AC-3 current of 18/6 x 10A = 30A. Using an XTCE032C (32A AC-3) contactor is recommended.



**AC Ratings—AC-6B Operation**

Description	XTCE650N	XTCE750N	XTCE820N	XTCEC10N	XTCEC14P	XTCEC16R	XTCEC20R
Capacitor loads Individual compensation rated operational current $I_{\theta}$ of three-phase capacitors in amperes							
Up to 525V	463	463	463	463	—	—	—
690V	265	265	265	265	—	—	—
Maximum inrush current peak ( $\times I_{\theta}$ )	30	30	30	30	—	—	—
Component lifesaving (operations)	100,000	100,000	100,000	100,000	—	—	—
Maximum operating frequency (ops/hr)	200	200	200	200	—	—	—

**AC Ratings—Four-Pole—AC-1 Operation**

Description	XTCF020B	XTCF032C	XTCF045C	XTCF063D	XTCF080D	XTCF125G	XTCF160G	XTCF200G
Conventional free air thermal current, three-pole, 50-60 Hz								
Open (amps)								
at 40°C ( $I_{th}$ )	22	32	45	3	80	125	160	200
at 50°C ( $I_{th}$ )	21	30	41	60	76	116	15	188
at 60°C ( $I_{th}$ )	20	28	39	54	69	108	138	172
Enclosed (amps)	18	27	36	50	64	100	128	160
Conventional free air thermal current, single-pole								
Open (amps)	60	84	117	162	207	325	415	516
Enclosed (amps)	54	76	105	146	186	292	373	464

**AC Ratings—Four-Pole—AC-3 Operation**

Description	XTCF020B	XTCF032C	XTCF045C	XTCF063D	XTCF080D	XTCF125G	XTCF160G	XTCF200G
Rated operational current, 50/60 Hz ( $I_{\theta}$ ) in amperes								
220/230V	12	18	25	40	50	80	95	115
240V	12	18	25	40	50	80	95	115
380/400V	12	18	25	40	50	80	95	115
415V	12	18	25	40	50	80	95	115
440V	12	18	25	40	50	80	95	115
500V	10	18	25	40	50	80	95	115
660/690V	7	12	15	25	32	65	80	93
Rated power, (P) in kilowatts								
220/230V	3.5	5	7.5	2.5	15.5	25	30	37
240V	4	5.5	8.5	13.5	17	27.5	33	40
380/400V	5.5	7.5	11	18.5	22	37	45	55
415V	7	10	14.5	24	30	48	57	70
440V	7.5	10.5	15.5	25	32	51	60	75
500V	47	12	17.5	28	36	58	70	85
660/690V	6.5	11	14	23	30	63	75	90

#### DC Ratings—DC-1

**Description**  
**Rated Operation**  
**Current {1} (I<sub>g</sub>) in**  
**Amperes**

	XTCE007B	XTCE009B	XTCE012B, XTCF020B	XTCE015B	XTCE018C	XTCE025C	XTCE032C	XTCE040D	XTCE050D	XTCE065D
60V	20	20	20	20	35	40	40	50	60	72
110V	20	20	20	20	35	40	40	50	50	72
220V	15	15	15	15	3	4	40	45	45	65
440V	1	1.3	1.3	1.3	2.9	2.9	2.9	2.9	2.9	2.9

	XTCE080F	XTCE095F	XTCE115G	XTCE150G	XTCE185H	XTCE225H	XTCE250L	XTCE300L	XTCE400M	XTCE500M
60V	110	110	160	160	300	300	300	300	400	400
110V	110	110	16	160	300	300	300	300	400	400
220V	70	70	90	90	300	300	300	300	400	400
440V	4.5	4.5	4.5	4.5	11	11	11	11	11	11

	XTCE580N	XTCE650N	XTCE750N	XTCE820N	XTCEC10N	XTCEC14P	XTCEC20R	XTCEC16R
60V	—	—	—	—	—	—	—	—
110V	—	—	—	—	—	—	—	—
220V	—	—	—	—	—	—	—	—
440V	—	—	—	—	—	—	—	—

#### DC Ratings—DC-3

**Description**  
**Rated Operation**  
**Current {1} (I<sub>g</sub>) in**  
**Amperes**

	XTCE007B	XTCE009B	XTCE012B	XTCE015B	XTCE018C	XTCE025C	XTCE032C	XTCE040D	XTCE050D	XTCE065D
60V	20	20	20	20	35	35	40	50	60	72
110V	20	20	20	20	35	35	40	50	50	72
220V	1.5	1.5	1.5	1.5	10	10	25	25	25	35
440V	0.2	0.2	0.2	0.2	0.6	0.6	0.6	0.6	0.6	0.6

	XTCE080F	XTCE095F	XTCE115G	XTCE150G	XTCE185H	XTCE225H	XTCE250L	XTCE300L	XTCE400M	XTCE500M
60V	110	110	160	160	300	300	300	300	400	400
110V	110	110	160	160	300	300	300	300	400	400
220V	35	35	40	40	300	300	300	300	400	400
440V	1	1	1	1	—	—	—	—	—	—

	XTCE580N	XTCE650N	XTCE750N	XTCE820N	XTCEC10N	XTCEC14P	XTCEC20R	XTCEC16R
60V	—	—	—	—	—	—	—	—
110V	—	—	—	—	—	—	—	—
220V	—	—	—	—	—	—	—	—
440V	—	—	—	—	—	—	—	—

**DC Ratings—DC-5**

Description Rated Operation Current {1} (I <sub>e</sub> ) in Amperes										
	XTCE007B	XTCE009B	XTCE012B	XTCE015B	XTCE018C	XTCE025C	XTCE032C	XTCE040D	XTCE050D	XTCE065D
60V	20	20	20	20	35	35	40	50	60	72
110V	20	20	20	20	35	35	40	50	50	72
220V	1.5	1.5	1.5	1.5	10	10	25	25	25	35
440V	0.2	0.2	0.2	0.2	0.6	0.6	0.6	0.6	0.6	0.6

Description Rated Operation Current {1} (I <sub>e</sub> ) in Amperes										
	XTCE080F	XTCE095F	XTCE115G	XTCE150G	XTCE185H	XTCE225H	XTCE250L	XTCE300L	XTCE400M	XTCE500M
60V	110	110	160	160	300	300	300	300	400	400
110V	110	110	160	160	300	300	300	300	400	400
220V	35	35	40	40	300	300	300	300	400	400
440V	1	1	1	1	—	—	—	—	—	—

Description Rated Operation Current {1} (I <sub>e</sub> ) in Amperes							
	XTCE580N	XTCE650N	XTCE750N	XTCE820N	XTCEC10N	XTCEC14P	XTCEC20R
60V	—	—	—	—	—	—	—
110V	—	—	—	—	—	—	—
220V	—	—	—	—	—	—	—
440V	—	—	—	—	—	—	—

**DC Ratings—Four-Pole—DC-1 Operation**

Description Rated Operation Current {1} (I <sub>e</sub> ) in Amperes								
	XTCF020B	XTCF032C	XTCF045C	XTCF063D	XTCF080D	XTCF125G	XTCF160G	XTCF200G
60V	22	32	45	63	80	125	160	200
110V	22	32	45	6	80	125	160	200
220V	6	32	45	63	80	125	160	200
440V	1.3	3	3	5	5	100	125	150

**DC Ratings—Four-Pole—DC-3 Operation**

Description Rated Operation Current {1} (I <sub>e</sub> ) in Amperes								
	XTCF020B	XTCF032C	XTCF045C	XTCF063D	XTCF080D	XTCF125G	XTCF160G	XTCF200G
60V	20	32	45	63	80	125	160	200
110V	20	32	45	63	80	125	160	200
220V	1.5	32	45	63	80	125	160	200
440V	0.2	6	6	8	8	75	95	115

**DC Ratings—Four-Pole—DC-5 Operation**

Description Rated Operation Current {1} (I <sub>e</sub> ) in Amperes								
	XTCF020B	XTCF032C	XTCF045C	XTCF063D	XTCF080D	XTCF125G	XTCF160G	XTCF200G
60V	20	32	45	63	80	125	160	200
110V	20	25	32	508	80	125	160	200
220V	1.5	15	22	38	70	100	125	150
440V	0.2	4	4	8	8	60	75	90

**Current Heat Loss (Three-Pole) in Watts**

Description	XTCE007B	XTCE009B	XTCE012B, XTCF020B	XTCE015B	XTCE018C	XTCE025C	XTCE032C	XTCE040D
Current heat loss (three-pole) in watts								
at $I_{th}$	3	3	3	3	7.3	9.6	12.1	11.3
at $I_e$ to AC-3/400V	0.37	0.6	1.1	1.8	1.9	3.8	6.1	7.2
Impedance per pole, megohms	2.5	2.5	2.5	2.5	2	2	2	1.5

	XTCE050D	XTCE065D	XTCE072D	XTCE080F	XTCE095F	XTCE115G	XTCE150G	XTCE170G
Current heat loss (three-pole) in watts								
at $I_{th}$	19	28.8	28.8	12.2	18.2	20.3	30.7	41.1
at $I_e$ to AC-3/400V	11.3	19	23	9.6	13.5	15.9	27.0	34.7
Impedance per pole, megohms	1.5	1.5	1.5	0.5	0.5	0.4	0.4	0.4

	XTCE185H	XTCE225H	XTCE250L	XTCE300L	XTCE400M	XTCE500M	XTCE580N	XTCE650N
Current heat loss (three-pole) in watts								
at $I_{th}$	34	45	55	37	58	113	61	69
at $I_e$ to AC-3/400V	16	23	28	21	37	58	32	41
Impedance per pole, megohms	—	—	—	—	—	—	—	—

	XTCE750N	XTCE820N	XTCEC10N	XTCEC14P	XTCEC20R	XTCEC16R
Current heat loss (three-pole) in watts						
at $I_{th}$	78	96	96	188	192	155
at $I_e$ to AC-3/400V	54	65	96	—	—	123
Impedance per pole, megohms	—	—	—	—	—	—

**Current Heat Loss (Four-Pole) in Watts**

Description	XTCF020B	XTCF032C	XTCF045C	XTCF063D	XTCF080D	XTCF125G	XTCF160G	XTCF200G
Current heat loss (four-pole) in watts								
at $I_{th}$	4.7	8.2	12	16	23	29	46	60
Impedance per pole, megohms	2.5	2	1.5	1	0.7	0.6	0.6	0.5

## Wiring Diagrams

## 7–150A XTGR Reversing Contactors

## Control Circuit—7–32A

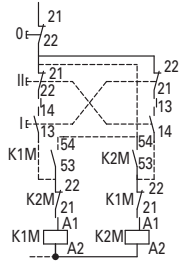

## Control Circuit—40–170A

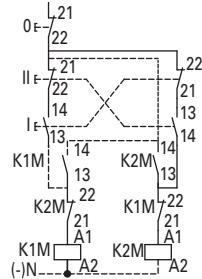

## Power Circuit—7–150A with Mechanical Interlock 80–150A on Mounting Plate

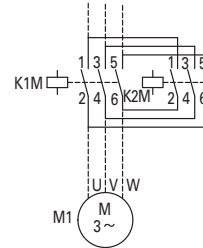

## Star-Delta (Wye-Delta) Starters

## Power Circuit—12–385A AC-3

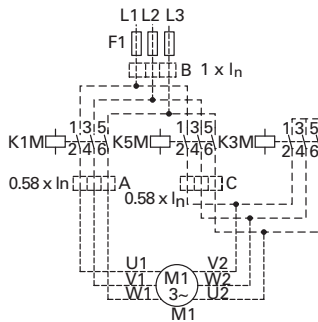

## XTCC Contactors for Three-Phase Capacitors

## Power Circuit—11–85 kVAR

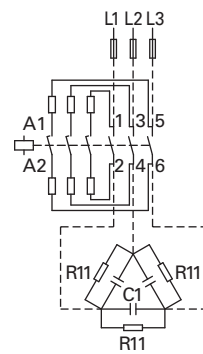

## Control Circuit—12–55A AC-3

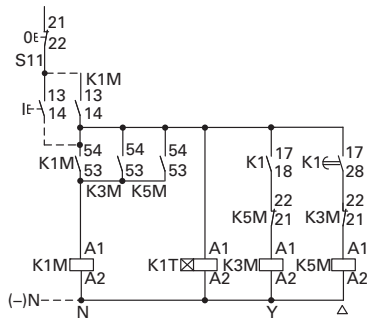

## Control Circuit—70–1700A AC-3

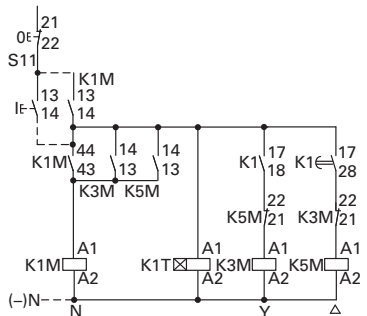

In the case of group compensation, multi-stage capacitor banks are connected to the mains, as required. In the process, transient currents of up to  $180 \times I_e$  can flow between the capacitors. The capacitors are pre-charged via the early-make auxiliary contacts and the fitted wire resistors, thereby reducing the inrush current. The main contacts then close after a time lag and carry the uninterrupted current. The contactors for capacitors are weld-resistant with inrush current peaks up to  $180 \times I_e$  due to their special contacts. For switching reactive-power compensation equipment with chokes, observe design notes.

For switching of power factor connection with reactors, please observe engineering notes, **Page V5-T1-64**. Use of the contactors XTCE without series resistor for centralized power factor correction—when using contactors for group compensation, a minimum inductance of approximately  $6 \mu\text{H}$  per capacitor must be available to limit the high inrush current peaks. This corresponds to an air-cored coil with 5 windings and a coil diameter of approximately 140 mm diameter. The conductor cross-section must be selected according to the rated current per phase.

### Contactor Contact Travel Diagrams

#### Frame B

##### XTCE 7–15A, XTC—AC

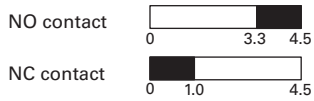

##### XTCEXSAC11

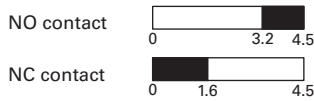

##### XTCEXF...LC\_



#### Frame C

##### XTCE 15–32A

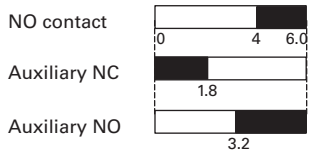

##### XTCEXSAC11, XTCEXF...C\_

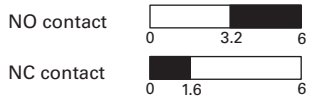

##### XTCEXF...LC\_

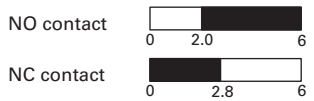

##### XTCE 7–9A—DC

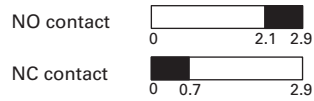

##### XTCEXSAC11

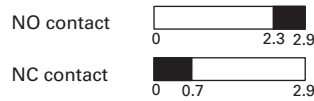

##### XTCEXF...LC\_

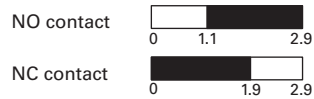

#### Frame D

##### XTCE 40–72A



##### XTCEXF...G\_

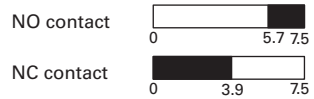

##### XTCEXF...LG\_

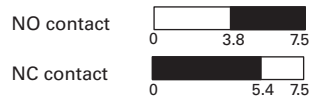

##### XTCEXS...N\_

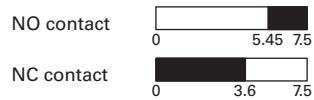

##### XTCEXSBLN11

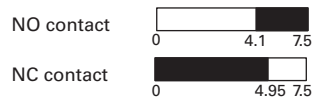

##### XTCE 12–15A, XTCF—DC

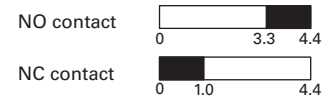

##### XTCEXSAC11

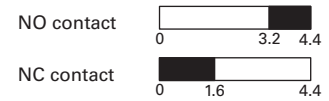

##### XTCEXF...LC\_

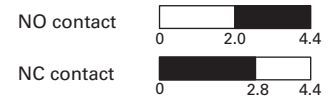

#### Frames F and G

##### XTCE 80–170A



##### XTCEXF...G\_

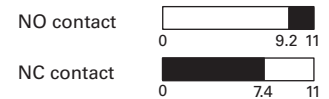

##### XTCEXF...LG\_

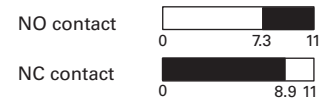

##### XTCEXS...N\_

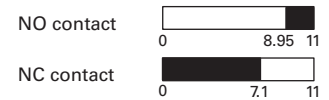

##### XTCEXSBLN11

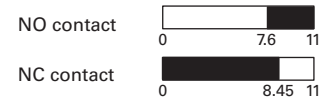

**Note:** The diagrams indicate the closing and travel of the contacts of the contactors and auxiliary contacts at no-load. Tolerances are not taken into consideration.

**Electrical Life Curves**

**Normal Switching Duty**

**XTCE007B–XTCE170G**

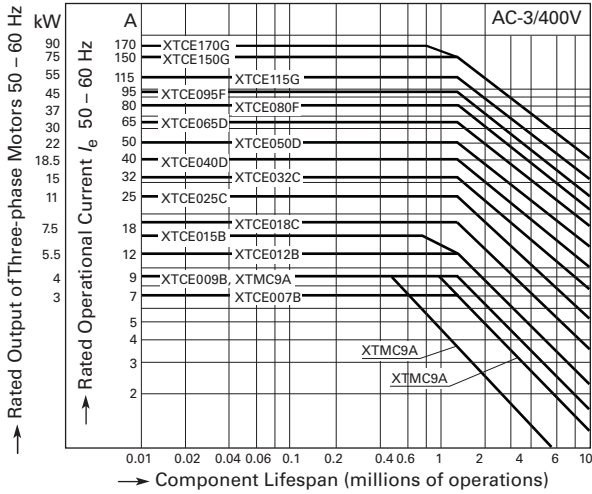

**XTCE185H–XTCEC16R**

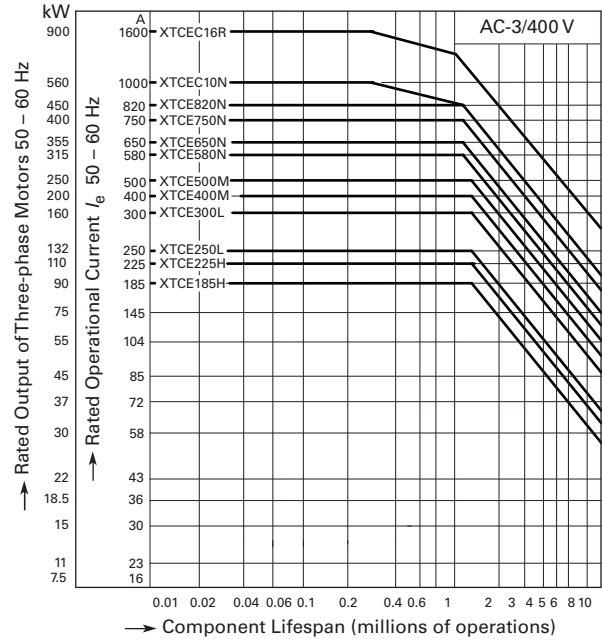

**Extreme Switching Duty**

**XTCE007B–XTCE170G**

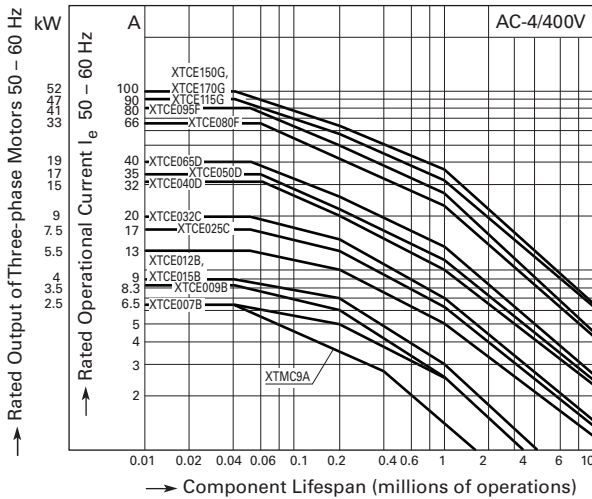

**XTCE185H–XTCEC16R**

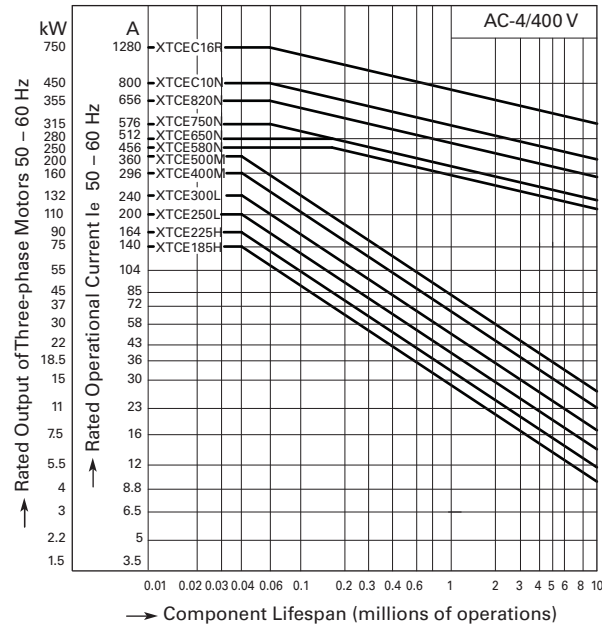

### Switching Duty for Non-Motor Loads

#### Three-Pole—XTCE007B–XTCEC20R

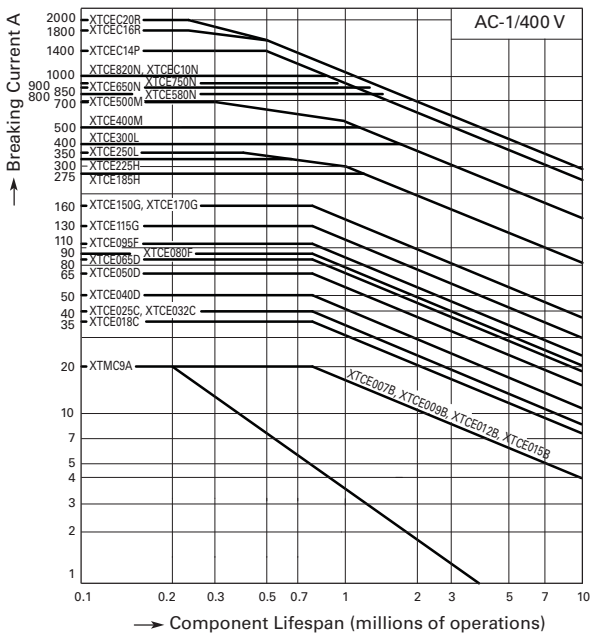

#### Four-Pole—XTCF020B–XTCF200G

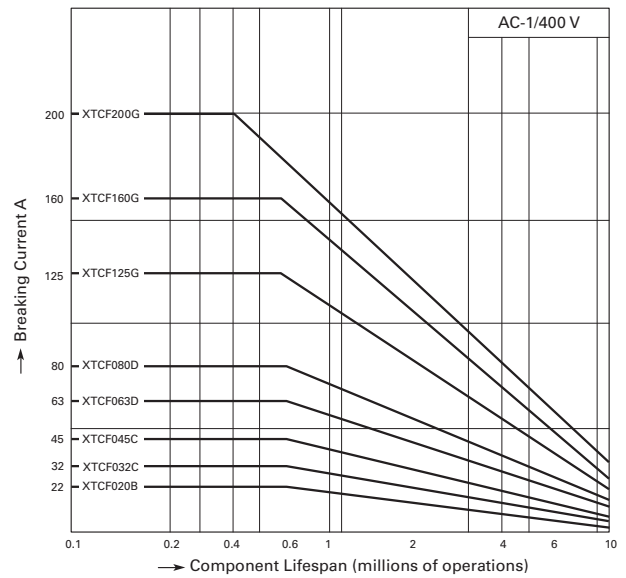

Operating characteristics:  
 Non-inductive and slightly inductive loads

Electrical characteristics:  
 Switch on: 1 x Rated current  
 Switch off: 1 x Rated current

Utilization category:  
 100% AC-1

Typical applications:  
 Electrical heating

### Short-Time Loading

#### Three-Pole—XTCE007B–XTCEC20R

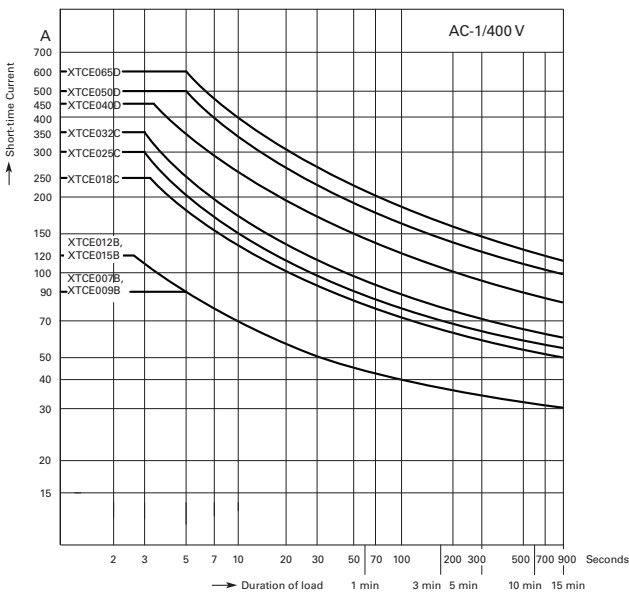

#### Three-Pole—XTCE080F–XTCEC16R

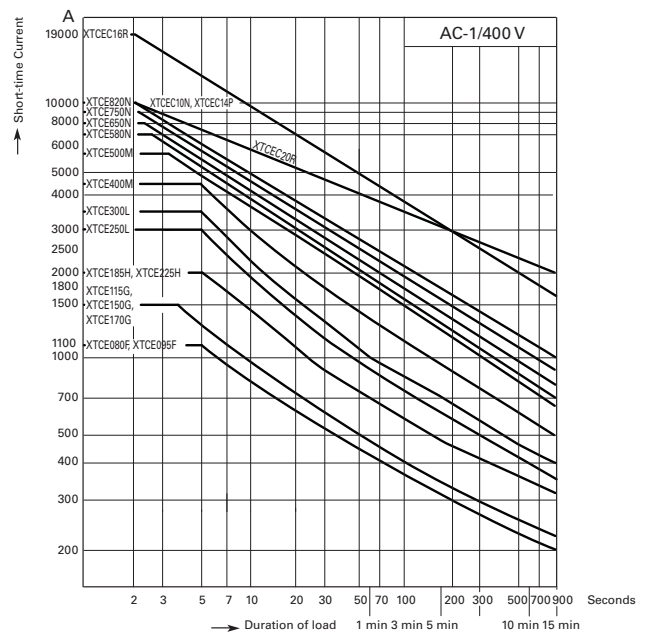

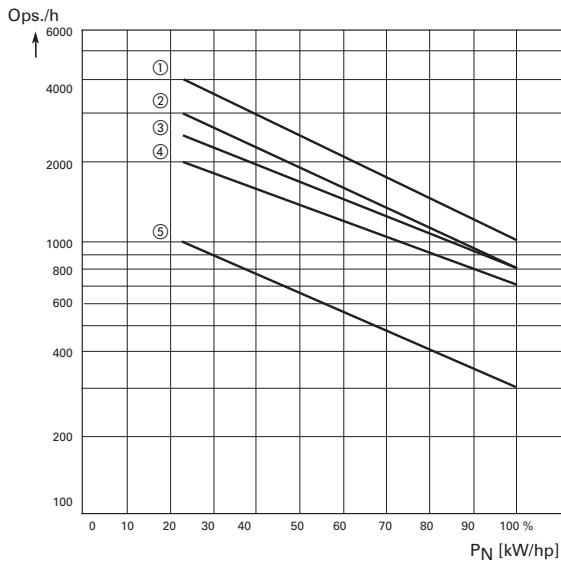
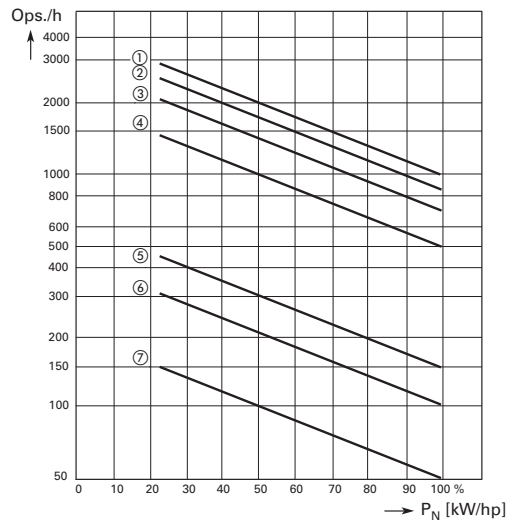

**Maximum Operating Frequency—Related to Rating and Utilization Category (400V)****7 to 150 hp****185 to 820 hp****Utilization Category ①**

Type	Characteristic Curve Above		
	AC-1	AC-3	AC-2, AC-4
XTCE007B–XTCE015B	3	1	5
XTCE018C–XTCE032C	3	2	5
XTCE040D–XTCE065D	3	2	5
XTCE080F–XTCE150G	3	4	5

**Utilization Category ①**

Type	Characteristic Curve Above		
	AC-1	AC-3	AC-2, AC-4
XTCE185H	2	1	6
XTCE225H	2	1	6
XTCE250L	2	1	6
XTCE300L	3	2	7
XTCE400M	3	2	7
XTCE500M	3	2	7
XTCE580N	3	4	5
XTCE650N	3	4	5
XTCE750N	3	4	5
XTCE820N	3	4	5

**Note**

- ①  $P_N$  = max. motor rating (kW/hp) of the relevant contactor.  
ops./h = max. number of operations per hour.

#### 1

#### Dimensions

Approximate Dimensions in mm [in]

#### XTCE Contactors (Three-Pole)

#### Frame B, XTCE007B and XTCE015B Contactors with Screw Terminals (7–15A) XTCE020B

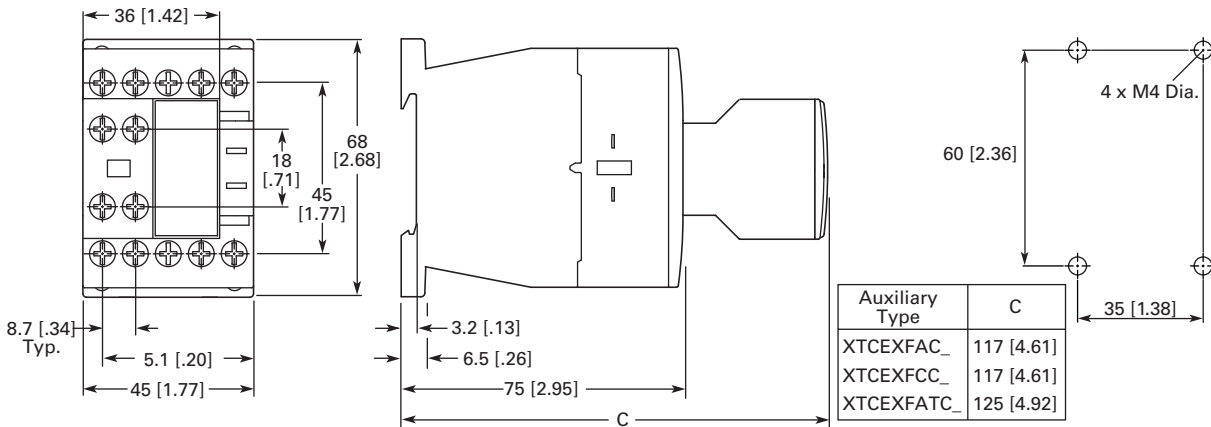

#### Frame B, XTCEC007B–XTCEC012B Contactors with Spring Cage Terminals (7–12A)

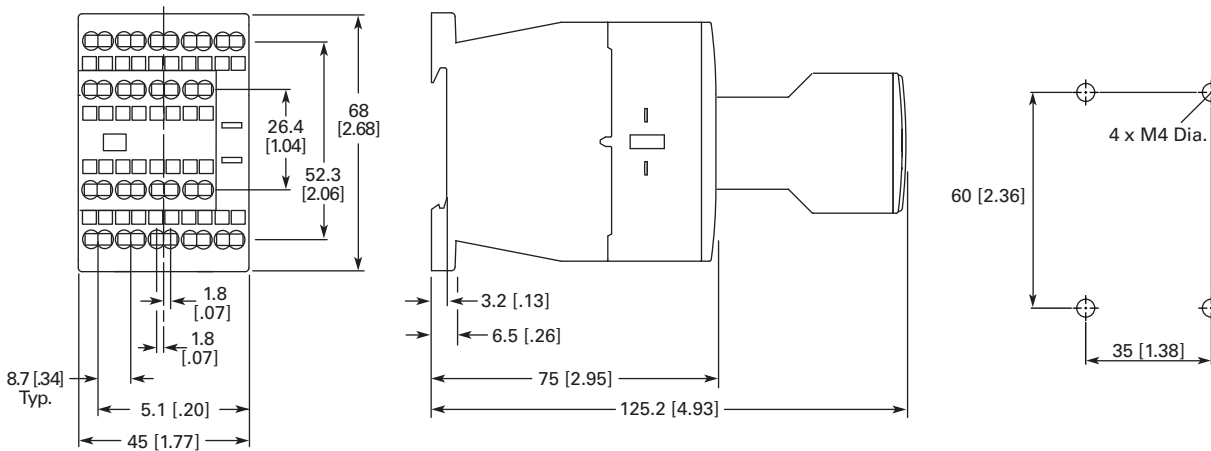

Approximate Dimensions in mm [in]

**Frame C, XTCE018C–XTCE032C Contactors (18–32A)**

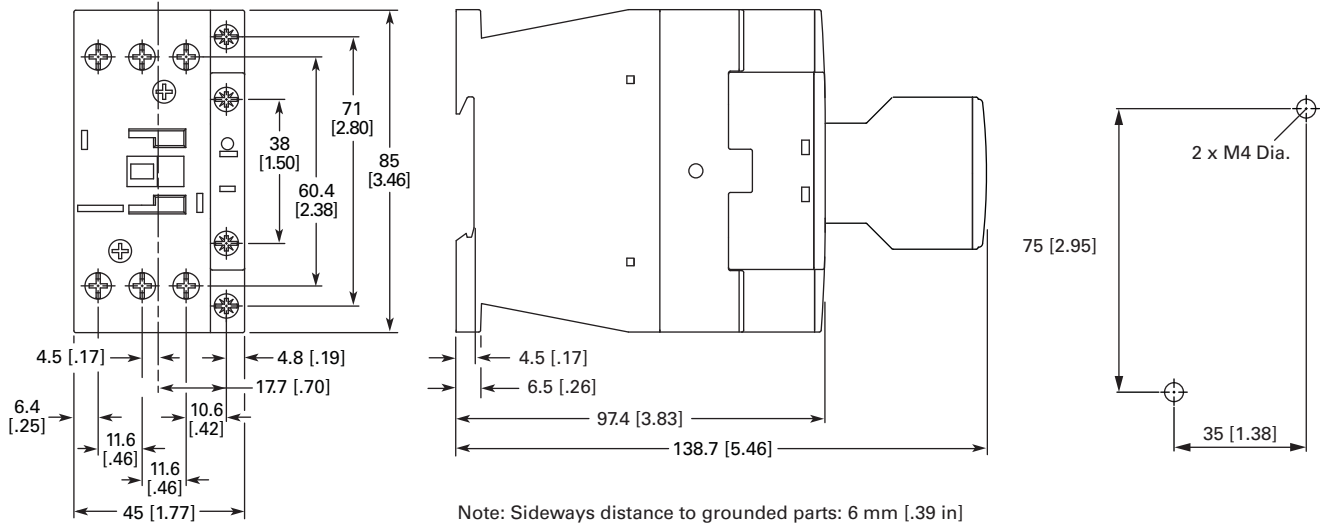

**Frame D, XTCE040D–XTCE072D Contactors (72A)**

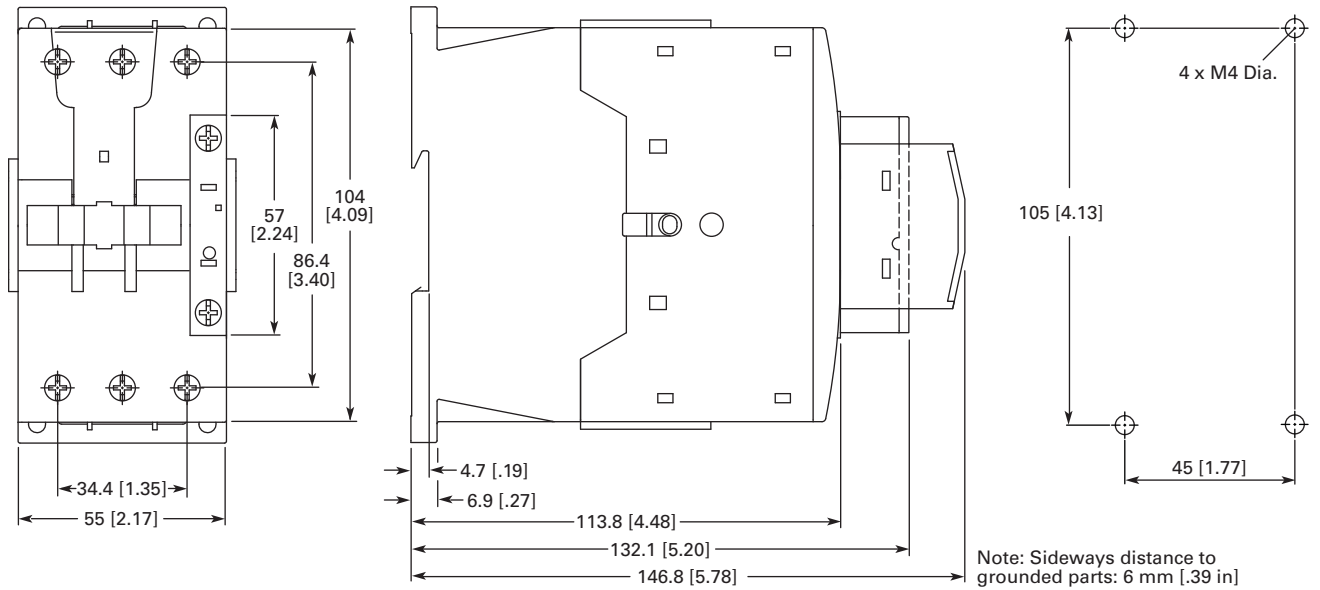

# 1.1

## IEC Contactors and Starters

### XT IEC Power Control

1

Approximate Dimensions in mm [in]

#### Frames F–G, XTCE080F–XTCE170G Contactors (80–170A)

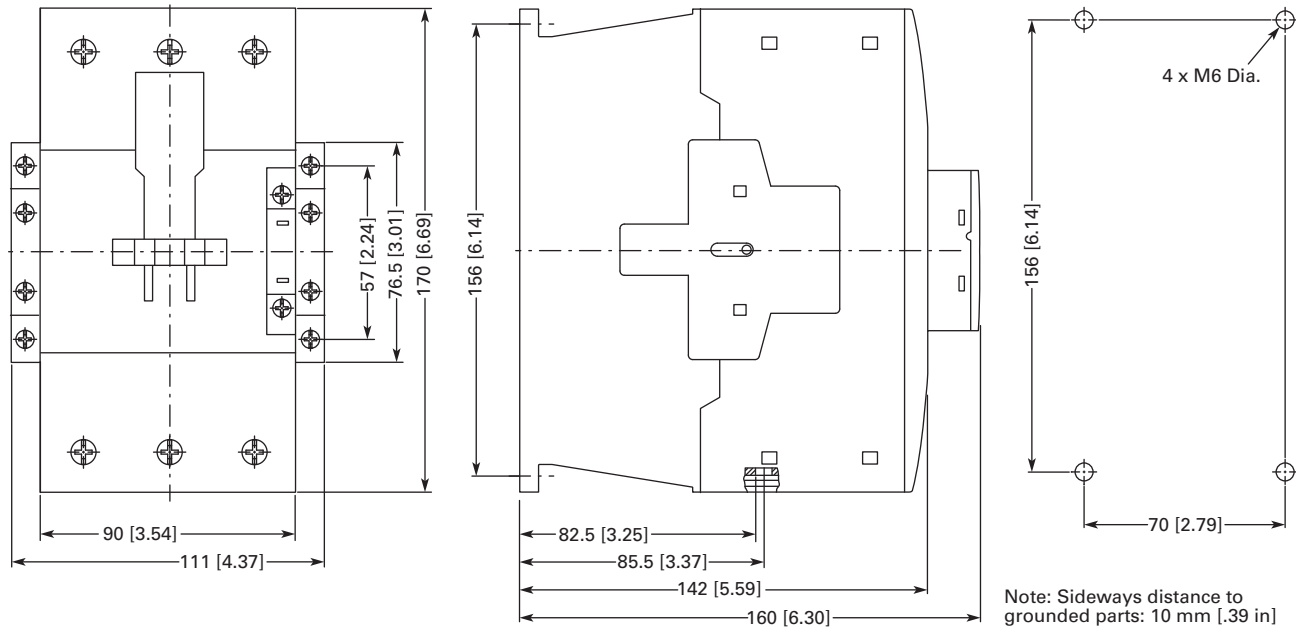

#### Frames H–M, XTCE185H–XTCE570M Contactors (185–580A)

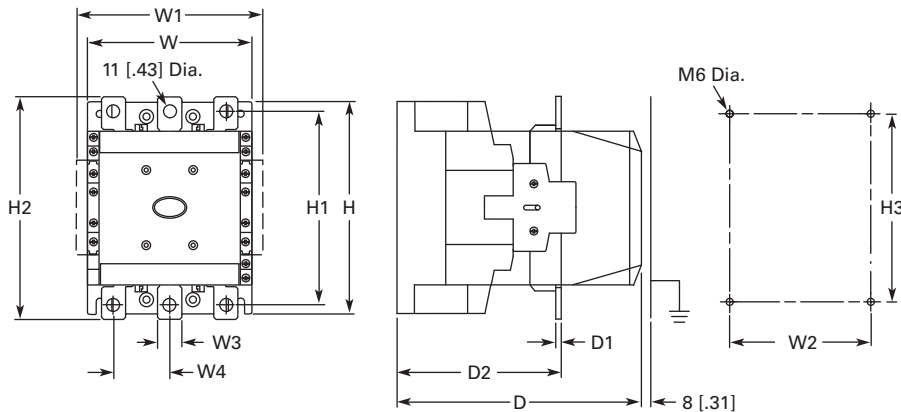

	W	W1	W2	W3	W4	H	H1	H2	H3	D	D1	D2
<b>Frame H</b>	140 [5.51]	160 [6.30]	120 [4.72]	20 [.79]	41 [1.61]	180 [7.09]	165 [6.50]	190 [7.48]	160 [6.30]	158 [6.22]	4 [.16]	83 [3.27]
<b>Frame L</b>	140 [5.51]	160 [6.30]	120 [4.72]	20 [.79]	48 [1.89]	180 [7.09]	164 [6.46]	189 [7.44]	160 [6.30]	208 [8.19]	5 [.20]	140 [5.51]
<b>Frame M</b>	160 [6.30]	180 [7.09]	130 [5.12]	25 [.98]	48 [1.89]	200 [7.87]	184 [7.24]	209 [8.23]	180 [7.09]	216 [8.50]	6 [.24]	140 [5.51]
	160 [6.30]	180 [7.09]	130 [5.12]	38 [1.50]	57 [2.24]	200 [7.87]	189 [7.44]	219 [8.62]	180 [7.09]	216 [8.50]	6 [.24]	140 [5.51]

Approximate Dimensions in mm [in]

**Frame N, XTCE580N–XTCEC10N Contactors (580–1000A)**

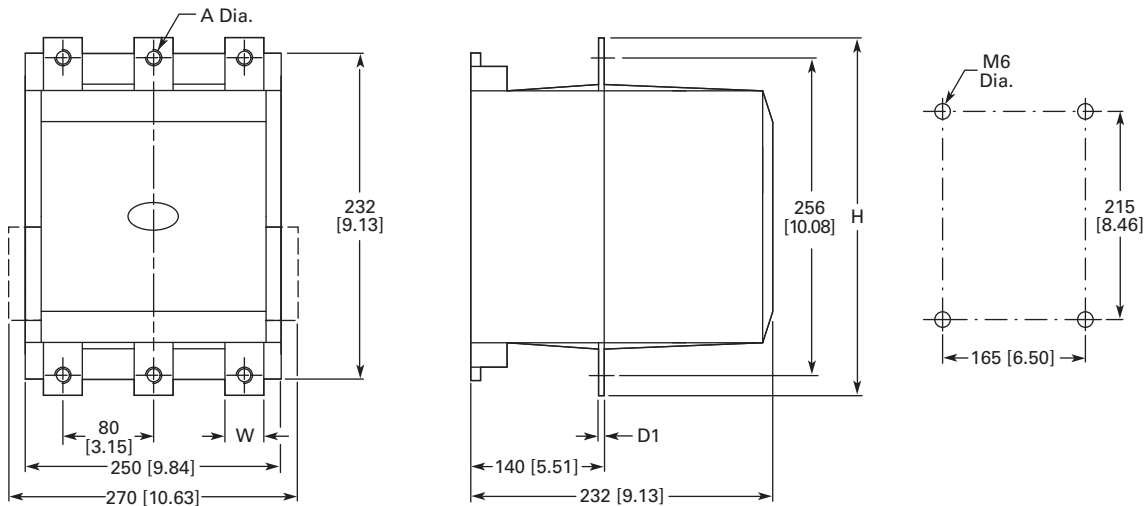

	W	H	D1	A (Dia.)
<b>XTCE580N</b>	45 [1.77]	296 [11.65]	6 [.24]	13.5 [.53]
<b>XTCE650N</b>	45 [1.77]	296 [11.65]	6 [.24]	13.5 [.53]
<b>XTCE750N</b>	45 [1.77]	296 [11.65]	6 [.24]	13.5 [.53]
<b>XTCE820N</b>	45 [1.77]	296 [11.65]	6 [.24]	13.5 [.53]
<b>XTCEC10N</b>	45 [1.77]	296 [11.65]	10 [.40]	13.5 [.53]

**Frame P, XTCEC14P Contactor (1400A, AC-1)**

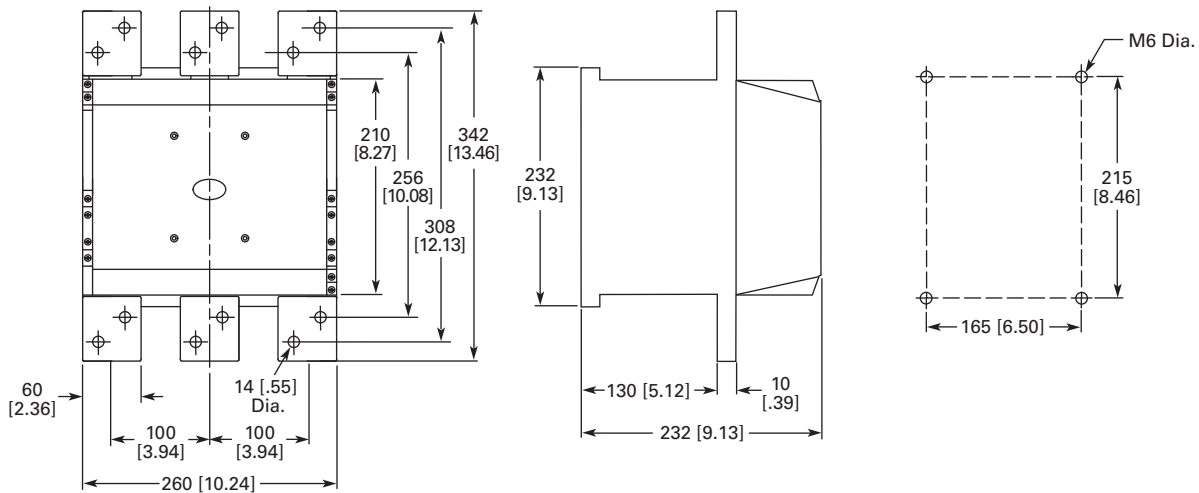

# 1.1

## IEC Contactors and Starters

**XT** IEC Power Control

1

Approximate Dimensions in mm [in]

### Frame R, XTCEC16R, XTCEC20R Contactors

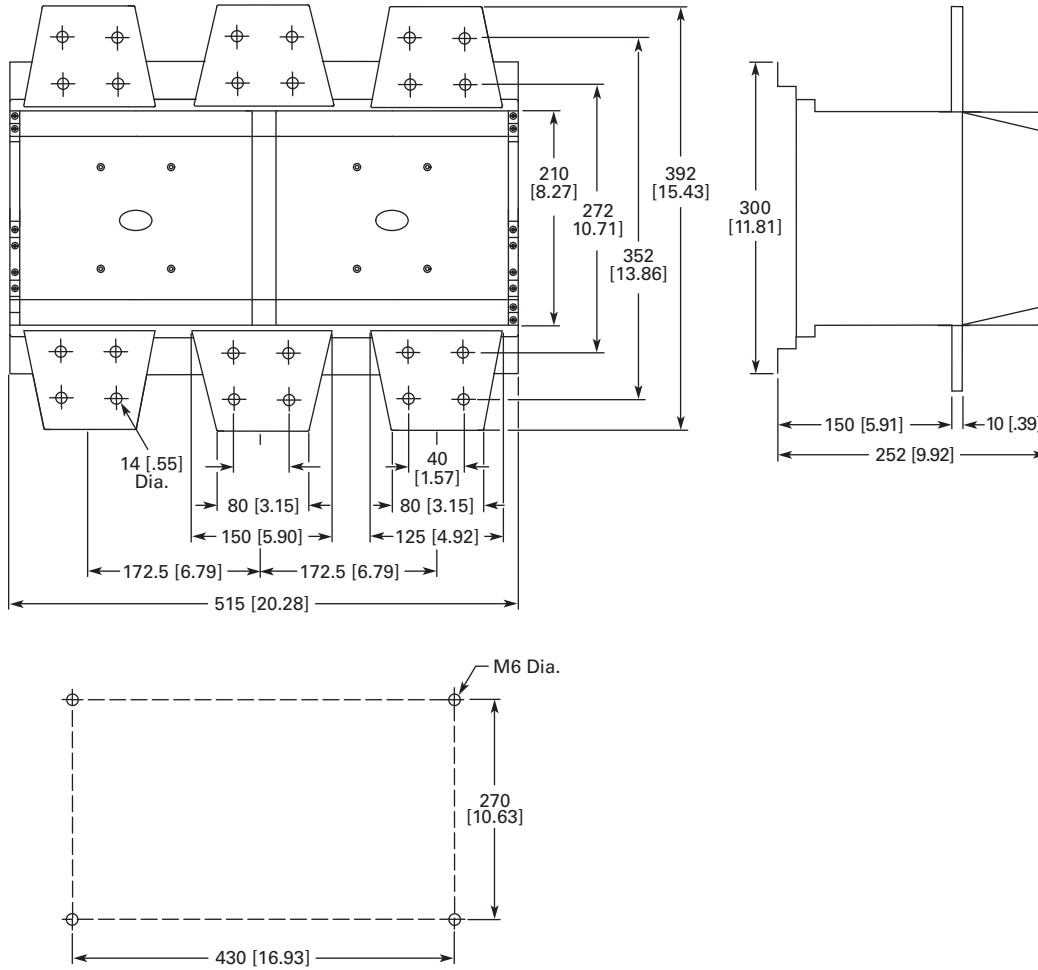

Approximate Dimensions in mm [in]

**XTCF Contactors (Four-Pole)**

**Frame B, XTCF020B Contactors**

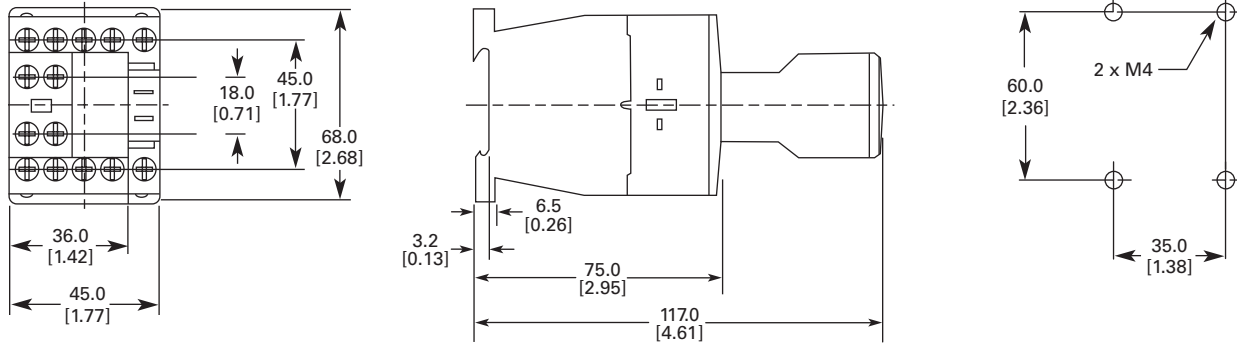

**Frame C, XTCF032C–XTCF045C Contactors**

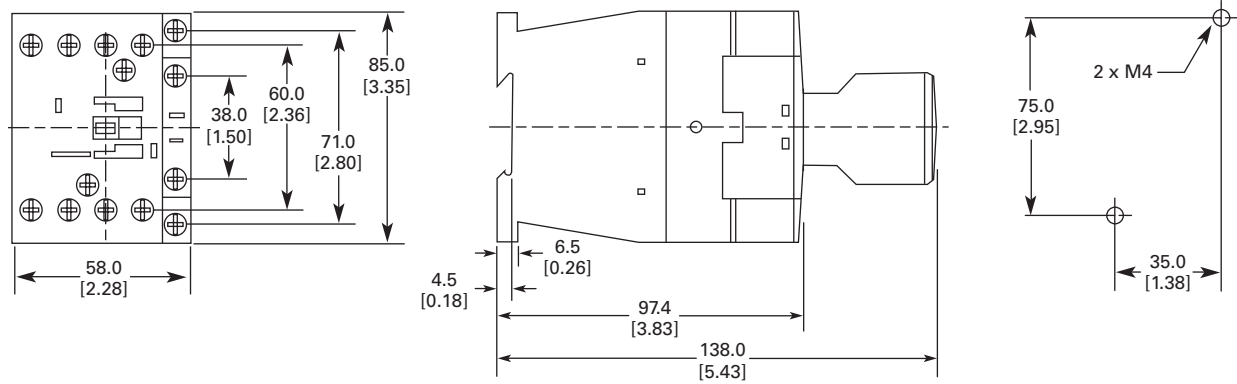

# 1.1

## IEC Contactors and Starters

### XT IEC Power Control

1

Approximate Dimensions in mm [in]

#### Frame D, XTFC063D–XTCF080D Contactors

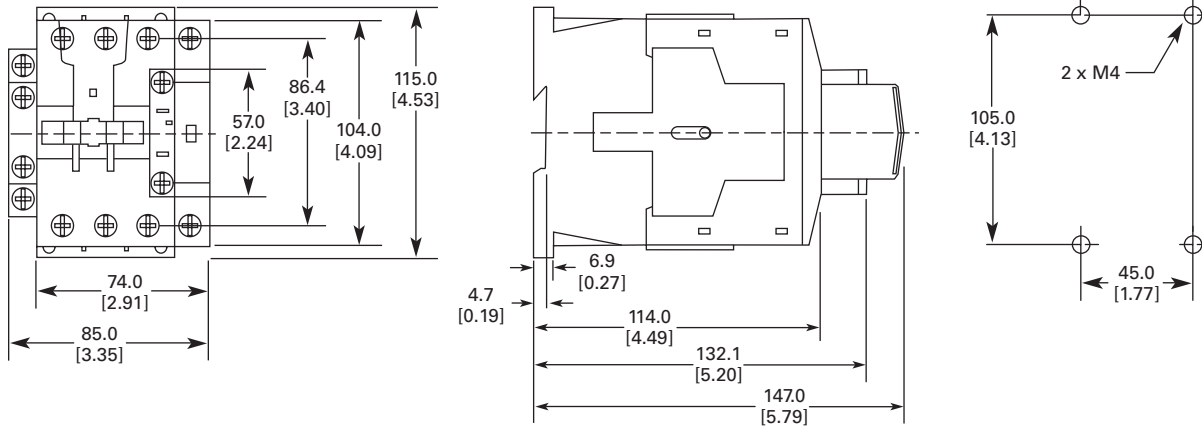

#### Frame G, XTFC125G–XTCF200G Contactors

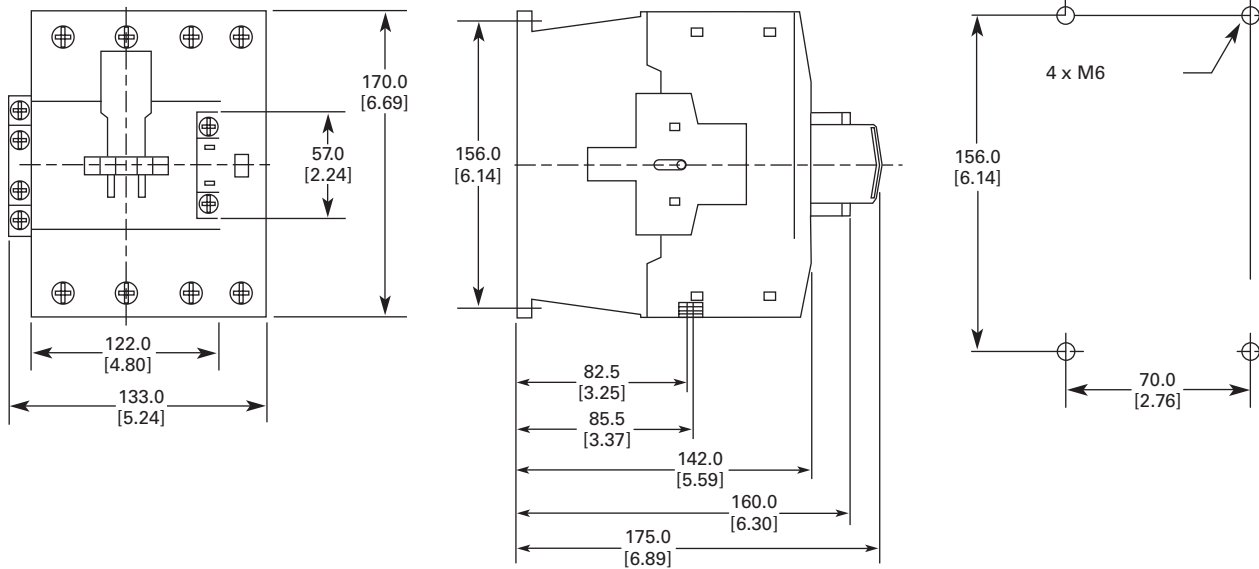



Approximate Dimensions in mm [in]

**XTAE Starters with XTOB Overload Relay**

**Frame B, XTAE007B–XTAE015B Starters with XTOB (7–12A)**

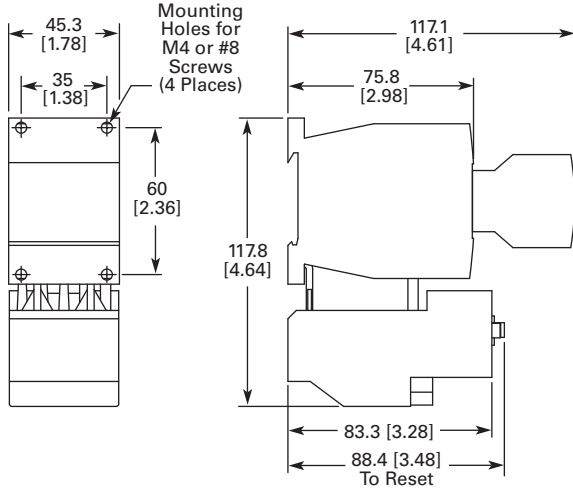

**Frame D, XTAE040D–XTAE065D Starters with XTOB (40–65A)**

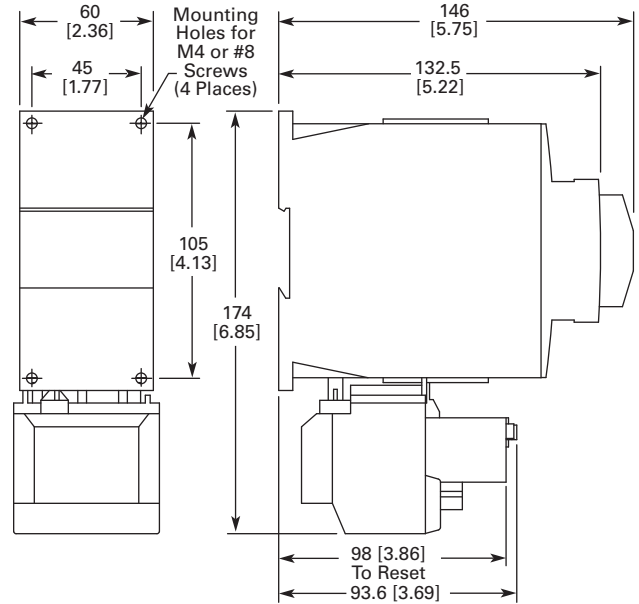

**Frame C, XTAE018C–XTAE032C Starters with XTOB (18–32A)**

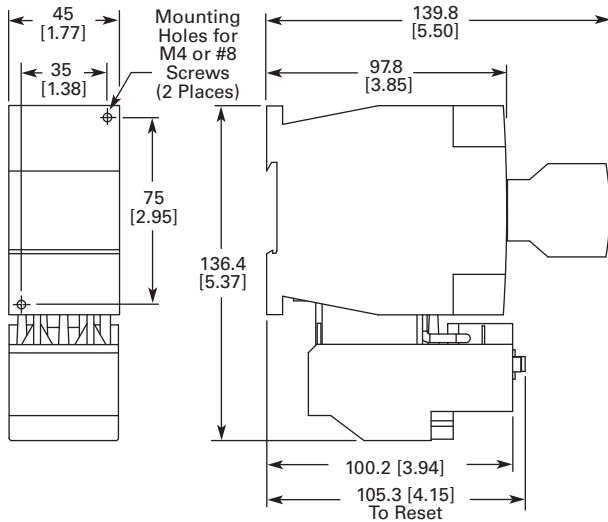

# 1.1

## IEC Contactors and Starters

### XT IEC Power Control

1

Approximate Dimensions in mm [in]

#### Frames F–G, XTAE080F–XTAE150G Starters with XTOB (80–150A)

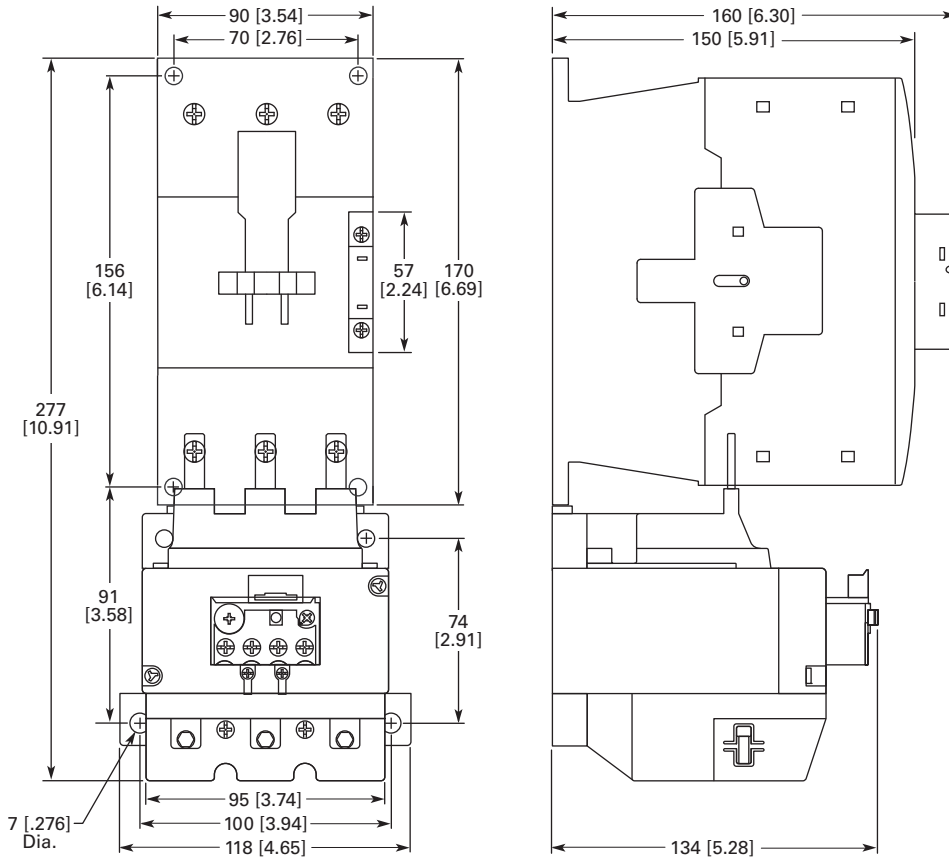

Approximate Dimensions in mm [in]

**XTAE Starters with XTOE Overload Relay**

**Frame B, XTAE007B–XTAE012B Starters with XTOE (0.35–20A)**

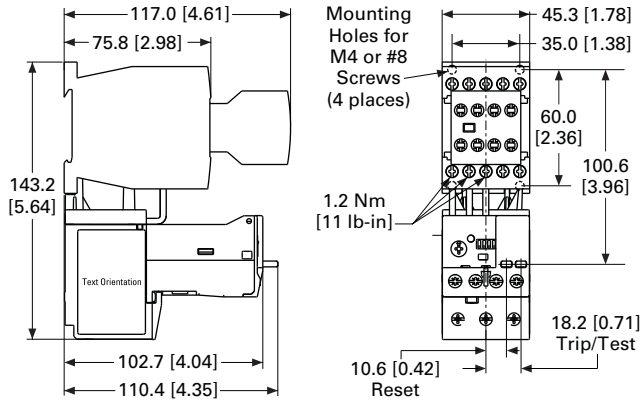

**Frame C, XTAE018C–XTAE032C Starters with XTOE (0.35–45A)**

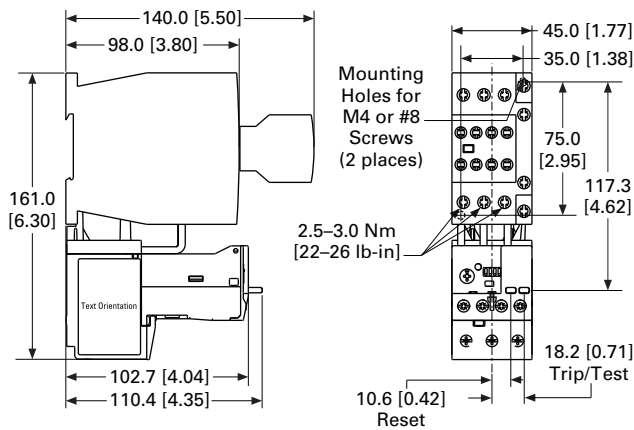

**Frame D, XTAE040D–XTAE065D Starters with XTOE (20–100A)**

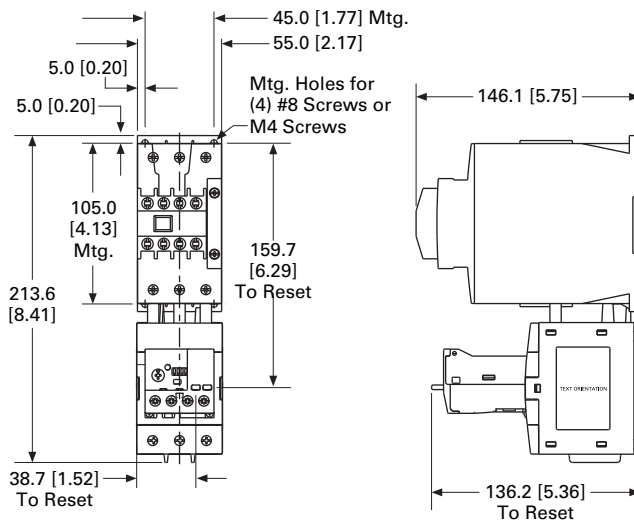

**Frames F–G, XTAE080F–XTAE115G Starters with XTOE (20–100A)**

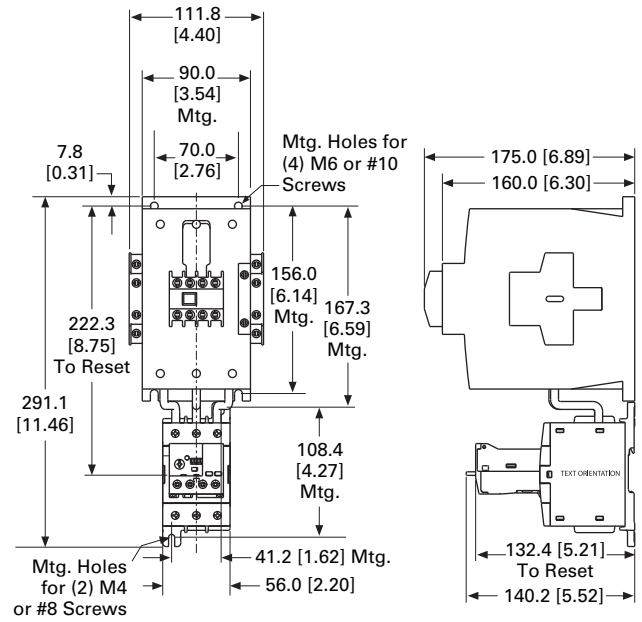

**Frame G, XTAE115G–XTAE150G Starters with XTOE (100–175A)**

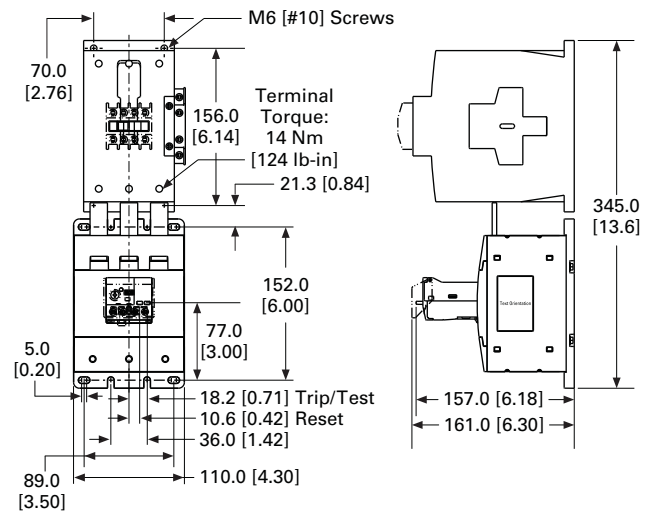

# 1.1

## IEC Contactors and Starters

### XT IEC Power Control

1

Approximate Dimensions in mm [in]

#### XTCR Reversing Combination

##### Frames B–D

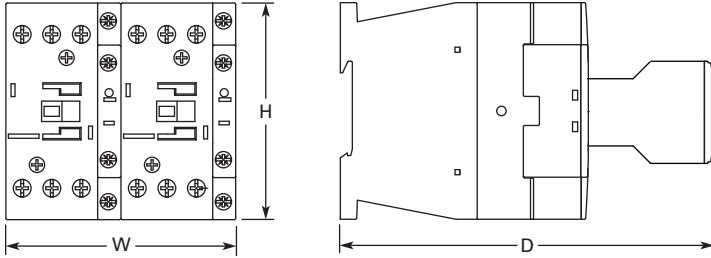

##### Frame B (7–15A)

W	H	D
90	68	117
[3.54]	[2.68]	[4.61]

##### Frame C (18–32A)

W	H	D
90	85	138
[3.54]	[3.34]	[5.43]

##### Frame D (40–65A)

W	H	D
110	115	146.8
[4.33]	[4.53]	[5.78]

##### Frames F–G

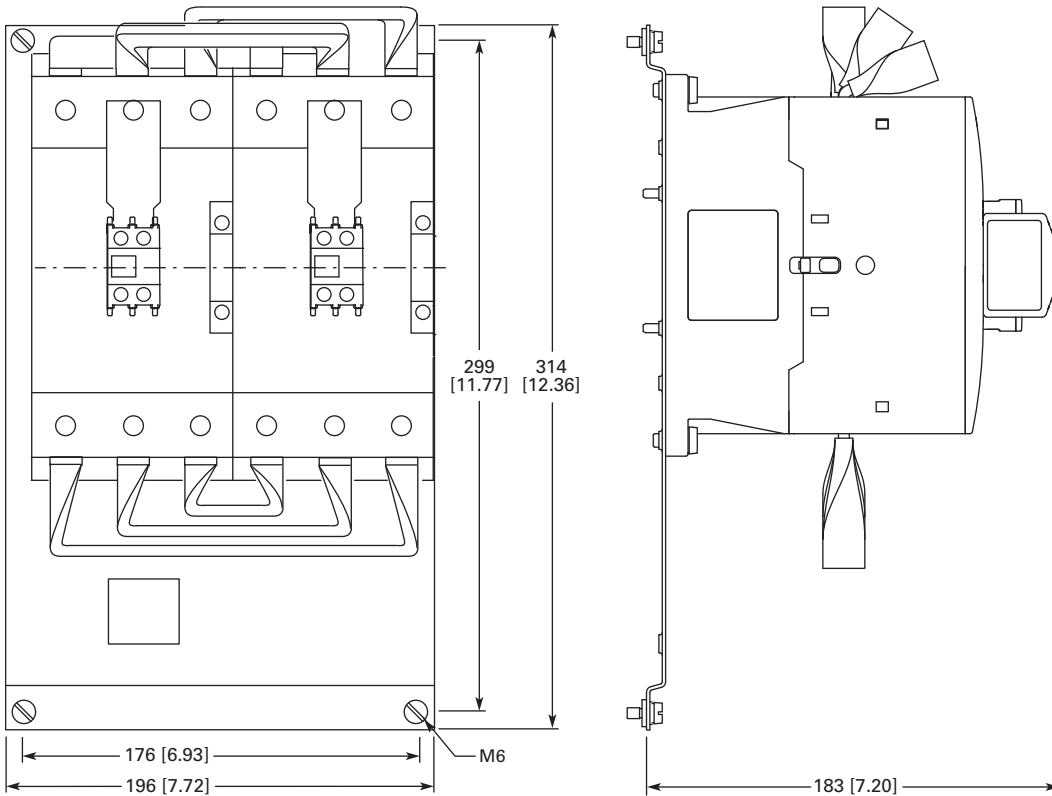

Approximate Dimensions in mm [in]

**Star-Delta Combination**

**Frames B–D**

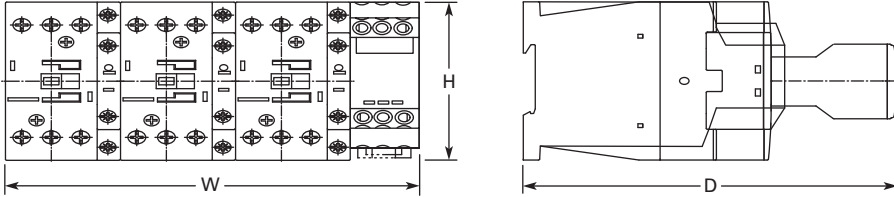

Frame B			Frame C			Frame D		
W	H	D	W	H	D	W	H	D
158	68	117	158	85	138	188	115	146.8
[6.22]	[2.68]	[4.61]	[6.22]	[3.34]	[5.43]	[7.40]	[4.53]	[5.78]

**Frames F–G**

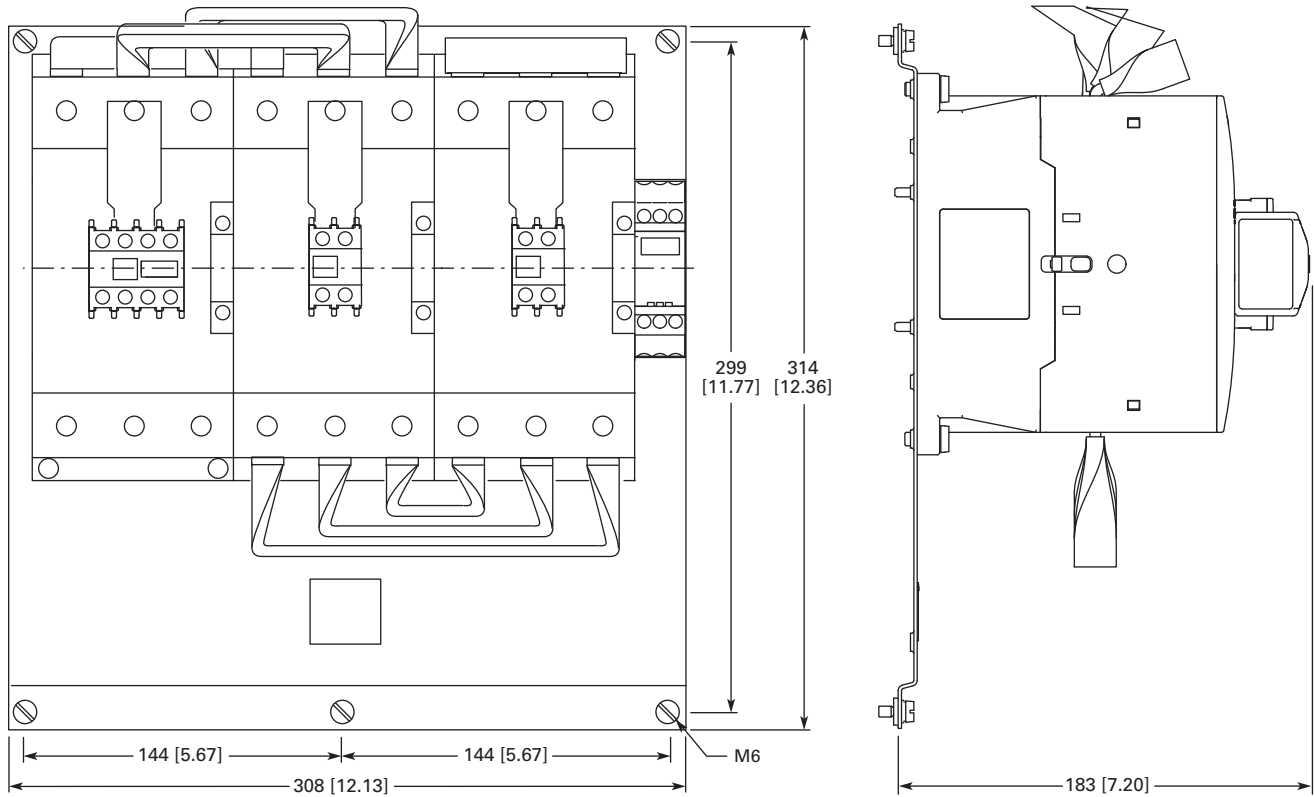

1

Approximate Dimensions in mm [in]

#### Mechanical Interlock

##### Frames H–M—XTCEXMLM

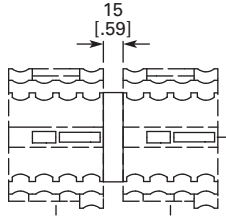

##### XTCEXMLN

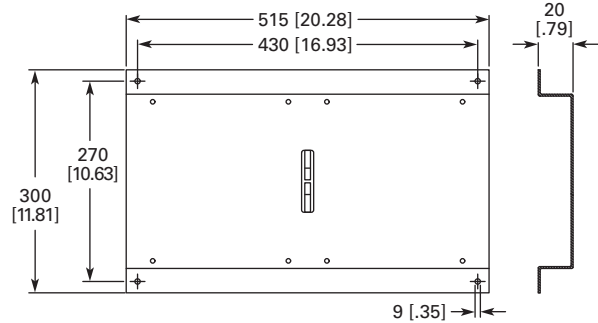

#### Contactors with Terminal Shroud

##### Frames L–N Contactors, XTCE250L–XTCEC10N, with Terminal Shroud XTLEXTS

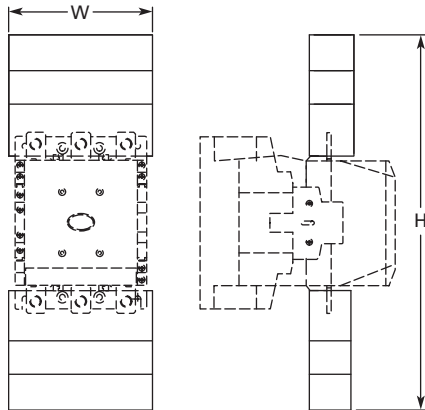

XTCE250L		XTCE400M		XTCE500M, XTCE570M		XTCE580N, XTCE650N, XTCE750N, XTCE820N, XTCEC10N	
W	H	W	H	W	H	W	H
150	384	150	404	174	426	236	506
[5.91]	[15.12]	[5.91]	[15.91]	[6.85]	[16.77]	[9.29]	[19.92]

Approximate Dimensions in mm [in]

**Suppressor**

**XTCE\_Suppressor**

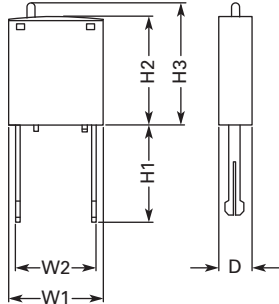

	W1	W2	H1	H2	H3	D
XTCEXRSB_	25	9.2	25.9	28	32	9
XTCEXVSB_	[.98]	[.36]	[1.02]	[1.10]	[1.26]	[.35]
XTCEXVSLB_						
XTCEXDDB_						
XTCEXRSC_	25	9.2	16	28	32	9
XTCEXVSC_	[.98]	[.36]	[.63]	[1.10]	[1.26]	[.35]
XTCEXVSLC_						
XTCEXRSF_	25	20	18.5	28	32	9
XTCEXVSF_	[.98]	[.79]	[.73]	[1.10]	[1.26]	[.35]
XTCEXVSLF_						

**Flat Strip Conductor Terminals**

**XTCEXTFB**

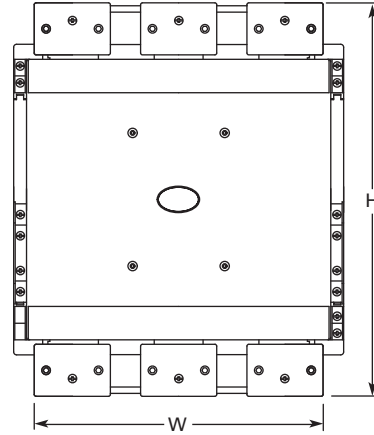

	W	H
XTCE500M–XTCE570M	171 [6.73]	232 [9.13]
XTCE750N–XTCE820N	231 [9.09]	310 [12.20]

**Cable Terminal Block**

**XTCEXTLA**

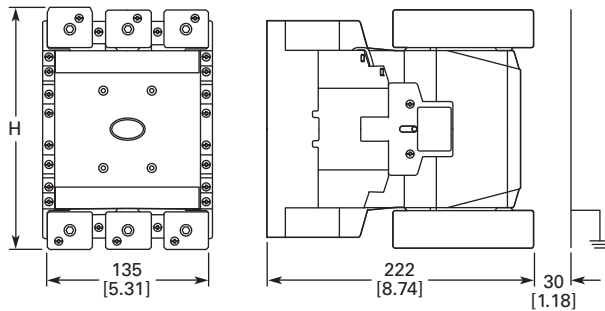

	H
XTCE250L	198 [7.80]
XTCE400M	218 [8.58]

**Three-Phase Commoning Link**

**Frame B**

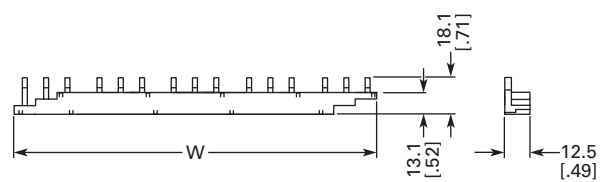

	W
XTCEXCLK3B	112 [4.41]
XTCEXCLK4B	157 [6.18]
XTCEXCLK5B	202 [7.95]

#### XTOB, XTOT Overload Relays



### Thermal Overload Relays

#### Product Description

The **XT** line of IEC motor thermal overload relays provides an efficient motor protection solution, available up to 630A. XTOB units can be directly mounted to the contactor or mounted separately.

#### Features and Benefits

- Direct connect up to 250A
- Stand alone and CT type up to 630A
- Large thermal overcurrent range
- Test button
- Manual/automatic selectable reset
- NO-NC auxiliary as standard
- Class 10A (to 250A)
- Class 30 (CT type)

### Contents

#### Description

	<i>Page</i>
Relays and Timers .....	<b>V5-T1-3</b>
Miniature Controls .....	<b>V5-T1-18</b>
Contactors and Starters .....	<b>V5-T1-35</b>
Thermal Overload Relays	
Catalog Number Selection .....	<b>V5-T1-129</b>
Product Selection .....	<b>V5-T1-130</b>
Accessories .....	<b>V5-T1-133</b>
Technical Data and Specifications .....	<b>V5-T1-136</b>
Dimensions .....	<b>V5-T1-138</b>
C440/ <b>XT</b> Electronic Overload Relay .....	<b>V5-T1-141</b>
Manual Motor Protectors .....	<b>V5-T1-157</b>
Combination Motor Controllers .....	<b>V5-T1-193</b>
<b>XT</b> Electronic Manual Motor Protector .....	<b>V5-T1-216</b>
Reference Data .....	<b>V5-T1-229</b>

#### Standards and Certifications

- IEC EN 60947
- CE approved
- UL
- CSA
- ATEX
- RoHS



#### Notes

Short-circuit protection: Observe the maximum permissible fuse of the contactor with direct device mounting. See MN03402001E for more information on overload relays for Frames B–G. Trip Class: 10A  
Suitable for protection of EEx e-motors. EC prototype test certificate available upon request. See manuals MN03402001E and MN03407001E, **Page V5-T1-133**.

#### Instructional Leaflets

- |          |   |
|----------|---|
| Pub51221 | XTOB, D Frame overload relays (inside of packaging)   |
| Pub51222 | XTOB, B–C Frame overload relays (inside of packaging) |



Catalog Number Selection

XT IEC Overload Relays

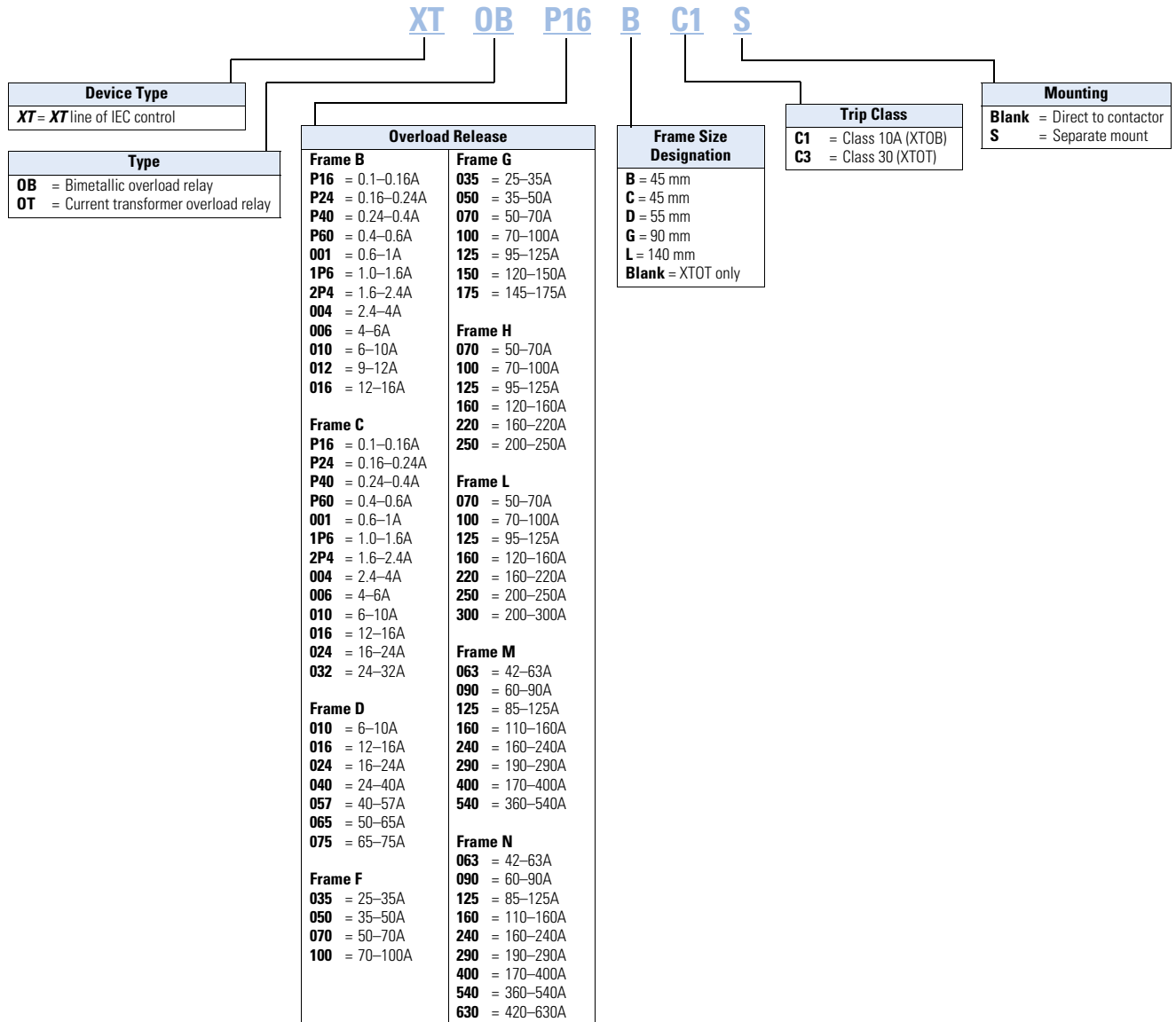

### Product Selection

#### Frame B



#### Overload Relay, Direct Mount—Frame B

Overload Releases, I <sub>r</sub>	Contact Sequence	Contact Configuration	For Use with Contactor Amp Range	Short-Circuit Protection (A)		Maximum Circuit Breaker	CEC/NEC Fuse	Catalog Number
				Fuse Type 1 Coordination, gG/gL	Type 2 Coordination, gG/gL			
0.1–0.16	97 95	1NO-1NC	7–15A	25	0.5	25	3	<b>XTOBP16BC1</b>
0.16–0.24		1NO-1NC	7–15A	25	1	25	3	<b>XTOBP24BC1</b>
0.24–0.4		1NO-1NC	7–15A	25	2	25	3	<b>XTOBP40BC1</b>
0.4–0.6		1NO-1NC	7–15A	25	4	25	3	<b>XTOBP60BC1</b>
0.6–1		1NO-1NC	7–15A	25	4	25	3	<b>XTOB001BC1</b>
1–1.6		1NO-1NC	7–15A	25	6	25	6	<b>XTOB1P6BC1</b>
1.6–2.4		1NO-1NC	7–15A	25	10	25	6	<b>XTOB2P4BC1</b>
2.4–4		1NO-1NC	7–15A	25	16	25	15	<b>XTOB004BC1</b>
4–6		1NO-1NC	7–15A	25	20	25	20	<b>XTOB006BC1</b>
6–10		1NO-1NC	7–15A	50	25	25	35	<b>XTOB010BC1</b>
9–12		1NO-1NC	9–15A	50	25	25	45	<b>XTOB012BC1</b>
12–16		1NO-1NC	12–15A	50	25	30	45	<b>XTOB016BC1</b>

#### Frame C



#### Overload Relay, Direct Mount—Frame C

Overload Releases, I <sub>r</sub>	Contact Sequence	Contact Configuration	For Use with Contactor Amp Range	Short-Circuit Protection (A)		Maximum Circuit Breaker	CEC/NEC Fuse	Catalog Number
				Fuse Type 1 Coordination, gG/gL	Type 2 Coordination, gG/gL			
0.1–0.16	97 95	1NO-1NC	18–32A	25	0.5	25	3	<b>XTOBP16CC1</b>
0.16–0.24		1NO-1NC	18–32A	25	1	25	3	<b>XTOBP24CC1</b>
0.24–0.4		1NO-1NC	18–32A	25	2	25	3	<b>XTOBP40CC1</b>
0.4–0.6		1NO-1NC	18–32A	25	4	25	3	<b>XTOBP60CC1</b>
0.6–1		1NO-1NC	18–32A	25	4	25	3	<b>XTOB001CC1</b>
1–1.6		1NO-1NC	18–32A	25	6	25	6	<b>XTOB1P6CC1</b>
1.6–2.4		1NO-1NC	18–32A	25	10	25	6	<b>XTOB2P4CC1</b>
2.4–4		1NO-1NC	18–32A	25	16	25	15	<b>XTOB004CC1</b>
4–6		1NO-1NC	18–32A	25	20	25	20	<b>XTOB006CC1</b>
6–10		1NO-1NC	18–32A	50	25	25	25	<b>XTOB010CC1</b>
10–16		1NO-1NC	18–32A	63	35	30	25	<b>XTOB016CC1</b>
16–24		1NO-1NC	18–32A	100	35	30	25	<b>XTOB024CC1</b>
24–32		1NO-1NC	25–32A	125	63	30	25	<b>XTOB032CC1</b>

## Frame D

## Overload Relay, Direct Mount—Frame D



Overload Releases, I <sub>r</sub>	Contact Sequence	Contact Configuration	For Use with Contactor Amp Range	Short-Circuit Protection (A)			CEC/NEC Fuse	Catalog Number
				Fuse Type 1 Coordination, gG/gL	Fuse Type 2 Coordination, gG/gL	Maximum Circuit Breaker		
6–10		1NO-1NC	40–72A	50	25	25	25	XTOB010DC1
10–16		1NO-1NC	40–72A	63	35	25	25	XTOB016DC1
16–24		1NO-1NC	40–72A	63	50	30	25	XTOB024DC1
24–40		1NO-1NC	40–72A	125	63	125	125	XTOB040DC1
40–57		1NO-1NC	50–72A	160	80	150	150	XTOB057DC1
50–65		1NO-1NC	65–72A	160	100	150	200	XTOB065DC1
65–75		1NO-1NC	72A	200	125	150	200	XTOB075DC1

## Frames F–G

## Overload Relay, Direct Mount—Frames F–G



Overload Releases, I <sub>r</sub>	Contact Sequence	Contact Configuration	For Use with Contactor Amp Range	Short-Circuit Protection (A)			CEC/NEC Fuse	Catalog Number
				Fuse Type 1 Coordination, gG/gL	Fuse Type 2 Coordination, gG/gL	Maximum Circuit Breaker		
25–35		1NO-1NC	80–170A	125	100	125	125	XTOB035GC1
35–50		1NO-1NC	80–170A	160	125	150	200	XTOB050GC1
50–70		1NO-1NC	80–170A	250	160	150	200	XTOB070GC1
70–100		1NO-1NC	80–170A	315	200	400	400	XTOB100GC1
95–125		1NO-1NC	80–170A	315	200	500	400	XTOB125GC1
120–150		1NO-1NC	80–170A	315	200	600	600	XTOB150GC1
145–175		1NO-1NC	150–170A	315	200	600	600	XTOB175GC1

## Frames F–G

## Overload Relay, Separate Mount—Frames F–G



Overload Releases, I <sub>r</sub>	Contact Sequence	Contact Configuration	For Use with Contactor Amp Range	Short-Circuit Protection (A)			CEC/NEC Fuse	Catalog Number
				Fuse Type 1 Coordination, gG/gL	Fuse Type 2 Coordination, gG/gL	Maximum Circuit Breaker		
25–35		1NO-1NC	80–170A	125	100	125	125	XTOB035GC1S
35–50		1NO-1NC	80–170A	160	125	150	200	XTOB050GC1S
50–70		1NO-1NC	80–170A	250	160	150	200	XTOB070GC1S
70–100		1NO-1NC	80–170A	315	200	400	400	XTOB100GC1S
95–125		1NO-1NC	80–170A	315	250	500	400	XTOB125GC1S
120–150		1NO-1NC	80–170A	315	250	600	600	XTOB150GC1S
145–175		1NO-1NC	150–170A	315	250	600	600	XTOB175GC1S

1

#### Frame H



#### Overload Relay, Separate Mount—Frame H

Overload Releases, I <sub>r</sub>	Contact Sequence	Contact Configuration	For Use with Contactor Amp Range	Short-Circuit Protection (A)		Maximum Circuit Breaker	CEC/NEC Fuse	Catalog Number
				Fuse Type 1 Coordination, gG/gL	Fuse Type 2 Coordination, gG/gL			
50–70	1 3 5 97 95	1NO-1NC	185–250A	250	160	150	200	XTOB070HC1
70–100	1 3 5 97 95	1NO-1NC	185–250A	315	200	400	400	XTOB100HC1
95–125	2 4 6 98 96	1NO-1NC	185–250A	315	250	500	400	XTOB125HC1
120–160		1NO-1NC	185–250A	400	250	600	600	XTOB160HC1
160–220		1NO-1NC	185–250A	400 <sup>①</sup>	315 <sup>①</sup>	600	800	XTOB220HC1
200–250		1NO-1NC	225–250A	400 <sup>①</sup>	315 <sup>①</sup>	600	700	XTOB250HC1

#### Frame L



#### Overload Relay, Separate Mount—Frame L

Overload Releases, I <sub>r</sub>	Contact Sequence	Contact Configuration	For Use with Contactor Amp Range	Short-Circuit Protection (A)		Maximum Circuit Breaker	CEC/NEC Fuse	Catalog Number
				Fuse Type 1 Coordination, gG/gL	Fuse Type 2 Coordination, gG/gL			
50–70	1 3 5 97 95	1NO-1NC	185–250A	250	160	150	200	XTOB070LC1
70–100	1 3 5 97 95	1NO-1NC	185–250A	315	200	400	400	XTOB100LC1
95–125	2 4 6 98 96	1NO-1NC	185–250A	315	250	500	400	XTOB125LC1
120–160		1NO-1NC	185–250A	400	250	600	600	XTOB160LC1
160–220		1NO-1NC	185–250A	400 <sup>①</sup>	315 <sup>①</sup>	600	800	XTOB220LC1
200–250		1NO-1NC	225–250A	400 <sup>①</sup>	315 <sup>①</sup>	600	700	XTOB250LC1
200–300		1NO-1NC	225–300A	630 <sup>①</sup>	630 <sup>①</sup>	600	700	XTOB300LC1

#### Frames M-N



#### Current Transformer Operated Overload Relays, Separate Mount—Frames M-N<sup>②</sup>

Overload Releases, I <sub>r</sub>	Contact Sequence	Contact Configuration	For Use with Contactor Amp Range	Short-Circuit Protection (A)		Circuit Breaker	CEC/NEC Fuse	Catalog Number
				Type 1 Coordination, gG/gL	Type 2 Coordination, gG/gL			
42–63	97 95	1NO-1NC	300–500A	—	—	150	200	XTOT063C3S
60–90	97 95	1NO-1NC	300–500A	—	—	250	250	XTOT090C3S
85–125	97 95	1NO-1NC	300–500A	—	—	500	400	XTOT125C3S
110–160	97 95	1NO-1NC	300–500A	—	—	600	600	XTOT160C3S
160–240	97 95	1NO-1NC	300–500A	—	—	600	700	XTOT240C3S
190–290	97 95	1NO-1NC	300–500A	—	—	600	700	XTOT290C3S
270–400	97 95	1NO-1NC	300–500A	—	—	1000	1000	XTOT400C3S
360–540	97 95	1NO-1NC	500A	—	—	600	1000	XTOT540C3S
420–630	97 95	1NO-1NC	630A	—	—	600	1000	XTOT630C3S

#### Notes

- ① For separate mounting, short-circuit Type 1 rating is 500A and short-circuit Type 2 rating is 400A.
- ② The main current parameters are defined by the main current wiring that is used.

## Accessories

## XTOBXDIN\_

**DIN Rail or Panel Mount Adapter,  
Frames C–D** <sup>①</sup>

For Use with...	Pkg. Qty. <sup>②</sup>	Catalog Number
XTOB...CC1	5	XTOBXDINC
XTOB...DC1	2	XTOBXDIND

## XTOBXTSL

**Terminal Shroud**

For Use with...	Catalog Number
XTOB...LC1	XTOBXTSL

## XTOBXTSCL

**Terminal Shroud**

For Direct Mounting of ...	Catalog Number
XTOB...LC1 to XTCE250L or XTCE300L	XTOBXTSCL

**Terminal Lug Kit—Set of Three Lugs**

Description	For Use with...	Pkg. Qty. <sup>②</sup>	Catalog Number
#6 AWG-350 kcmil	XTOB...LC1	1	XTOBXTLL

**Documentation—Manuals for Overload Monitoring  
of EEX e-motors**

Publication Number	For Use with...
MN03402001E	XTOB...BC1 XTOB...CC1
MN03407001E	XTOB...DC1 XTOB...GC1

**Notes**

- ① Can be snap fitted on a top hat rail (DIN rail) to IEC/EN 60715 or can be screw fitted.
- ② Orders must be placed in multiples of package quantity listed.

1

### Overload Fitted Directly to the Contactor

Frame B (7–15A)

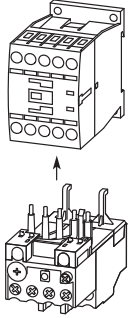

Frame C (18–32A)

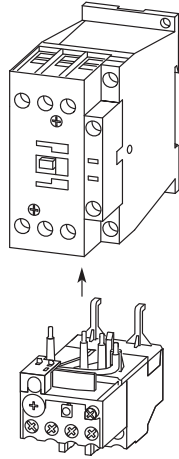

Frame D (40–72A)

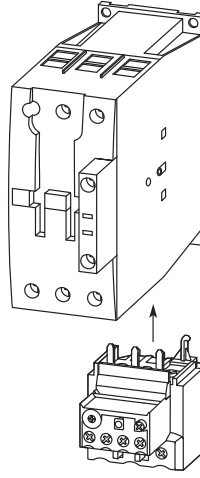

Frames F–G (80–170A)

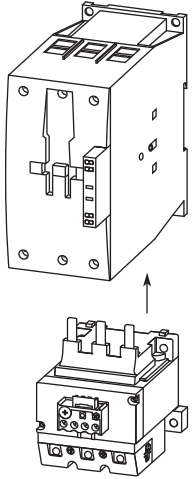

Frames H–L (185–250A)

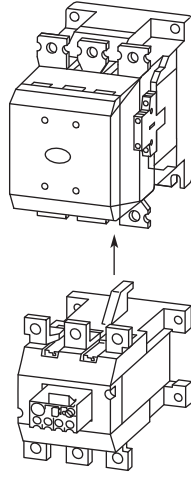

### Overload Mounted Separately from the Contactor

Frame C (18–32A)

Frame D (40–72A)

Frames F–G (80–170A)

Frames H–L (185–250A)

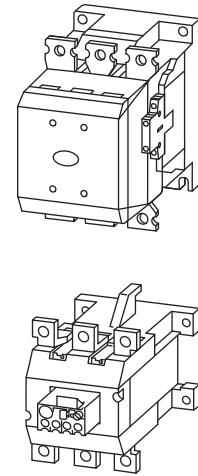
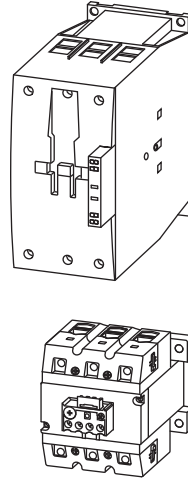
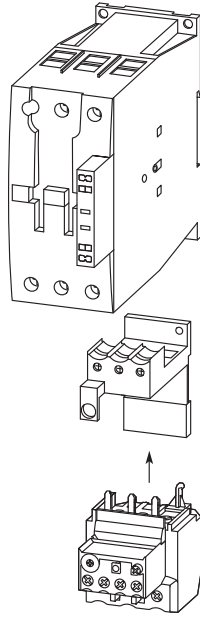
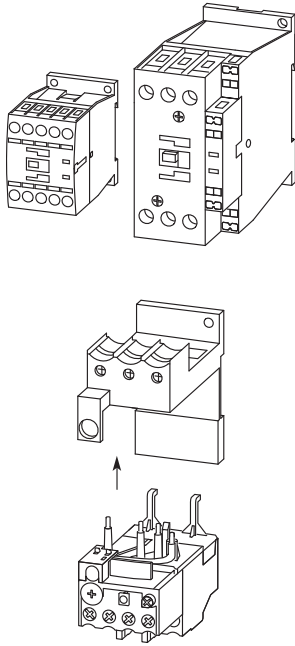

## Technical Data and Specifications

### XTOB Overload Relay—General

Description	XTOB...BC1, XTOB...CC1	XTOB...DC1	XTOB...GC1, XTOB...GC1S	XTOB...HC1, XTOB...LC1
Standards	IEC/EN 60947, VDE 0660, UL, CSA	IEC/EN 60947, VDE 0660, UL, CSA	IEC/EN 60947, VDE 0660, UL, CSA	IEC/EN 60947, VDE 0660, UL, CSA
Climate proofing	①	①	①	①
Ambient temperature ②	–25°C to 55°C [–13°F to 131°F]	–25°C to 55°C [–13°F to 131°F]	–25°C to 55°C [–13°F to 131°F]	–25°C to 50°C [–13°F to 122°F]
Temperature compensation	Continuous	Continuous	Continuous	Continuous
Mechanical shock resistance (IEC/EN 60068-2-27) half-sinusoidal shock 10 ms	10g	10g	10g	10g
Degree of protection	IP20	IP20	IP20	P00
Protection against direct contact when actuated from front (IEC 536)	Finger and back-of-hand proof	Finger and back-of-hand proof	Finger and back-of-hand proof	Finger and back-of-hand proof
Insulation voltage (U <sub>i</sub> ) Vac	690	690	690	1000
Overvoltage category/pollution degree	III/3	III/3	III/3	III/3
Impulse withstand voltage (U <sub>imp</sub> ) Vac	6000	6000	6000	8000
Operational voltage (U <sub>o</sub> ) Vac	690	690	690	1000
Safe isolation to VDE 0106 Part 101 and part 101/A1				
between auxiliary contacts and main contacts (Vac)	440	440	440	500
between main contacts (Vac)	440	440	440	500
Overload release setting range	0.1–32A	6–75A	25–150A	50–300A
Short-circuit protection maximum fuse	See overload relay tables starting on <b>Page V5-T1-144</b> .			
Temperature compensation residual error >40°C	<0.25	<0.25	<0.25	<0.25
Current heat loss (three conductors)				
Lower value of setting range, W	2.5	3	16	16
Upper value of setting range	6	7.5	28	28
Terminal capacity				
Solid, mm <sup>2</sup>	2 x (1–6)	2 x (1–16)	2 x (4–16)	—
Flexible with ferrule, mm <sup>2</sup>	2 x (1–4) 2 x (1–6) ③	1 x 25 2 x (1–10) ④	1 x (4–70) 2 x (4–50)	—
Flexible with cable lug, mm <sup>2</sup>	—	—	—	50–240
Stranded with cable lug, mm <sup>2</sup>	—	—	—	50–240
Solid or stranded, AWG	14 - 8	14 - 2	3 / 0	250 kcmil
Flat conductor (number of segments x width x thickness, mm <sup>2</sup> )	—	—	—	6 x 16 x 0.8
Busbar—width (mm)	—	—	—	25
Terminal screw	M4	M6	M10	M10 x 35
Tightening torque				
Nm	1.8	3.5	10	18
Lb-in	16	31	88.5	159.31
Tools				
Pozidriv screwdriver	Size 2	Size 2	—	—
Standard screwdriver	1 x 6	1 x 6	—	—
Hexagon socket head spanner (SW)	—	—	5 mm	16 mm

#### Notes

- ① Damp heat, constant, to IEC 60068-2-78; damp heat, cyclic, to IEC 60068-2-30.
- ② Ambient temperature operating range to IEC/EN 60947, PTB: –5°C to 50°C.
- ③ 6 mm<sup>2</sup> flexible with ferrules to DIN 46228.
- ④ Main contact terminal capacity, solid and stranded conductors with ferrules: When using two conductors use identical cross-section.



**XTOB Overload Relay—Auxiliary and Control Circuit Connections**

Description	XTOB...BC1, XTOB...CC1	XTOB...DC1	XTOB...GC1, XTOB...GC1S	XTOB...HC1, XTOB...LC1
Impulse withstand voltage ( $U_{imp}$ ) Vac	6000	6000	6000	4000
Overvoltage category/pollution degree	III/3	III/3	III/3	III/3
Terminal capacity				
Solid, mm <sup>2</sup>	2 x (0.75–4)	2 x (0.75–4)	2 x (0.75–4)	2 x (0.75–4)
Flexible with ferrule, mm <sup>2</sup>	2 x (0.75–2.5)	2 x (0.75–2.5)	2 x (0.75–2.5)	2 x (0.75–2.5)
Solid or stranded (AWG)	2 x (18–12)	2 x (18–12)	2 x (18–12)	2 x (18–12)
Terminal screw	M3.5	M3.5	M3.5	M3.5
Tightening torque				
Nm	0.8–1.2	0.8–1.2	0.8–1.2	0.8–1.2
Lb-in	7–10.6	7–10.6	7–10.6	7–10.6
Tools				
Pozidriv screwdriver	Size 2	Size 2	Size 2	Size 2
Standard screwdriver	1 x 6	1 x 6	1 x 6	1 x 6
Rated insulated voltage ( $U_i$ ) Vac	500	500	500	500
Rated operational voltage	500	500	500	500
Safe isolation to VDE 0106 Part 101 and part 101/A1 between auxiliary contacts	240	240	240	240
Conventional thermal current, $I_{th}$	6	6	6	6
Rated operational current—AC-15				
Make contact				
120V	1.5	1.5	1.5	1.5
240V	1.5	1.5	1.5	1.5
415V	0.5	0.5	0.5	0.5
500V	0.5	0.5	0.5	0.5
Break contact				
120V	1.5	1.5	1.5	1.5
240V	1.5	1.5	1.5	1.5
415V	0.9	0.9	0.9	0.9
500V	0.8	0.8	0.8	0.8
Rated operational current—DC-13 L/R ≤15 ms <sup>①</sup>				
24V	0.9	0.9	0.9	0.9
60V	0.75	0.75	0.75	0.75
110V	0.4	0.4	0.4	0.4
220V	0.2	0.2	0.2	0.2
Short-circuit rating without welding maximum fuse, A gG/gI	6	6	6	6

**Note**

① Rated operational current: Making and breaking conditions to DC-13, L/R constant as stated.

#### Tripping Characteristics

These tripping characteristics are the mean values of the spread at 20°C ambient temperature in a cold state.

Tripping time depends on response current. With devices at operating temperature, the tripping time of the overload relay reduces to approximately

25% of the read off value. Specific characteristics for each individual setting range can be found in MN03402001E.

#### XTOB...BC1, XTOB...CC1, XTOB...DC1

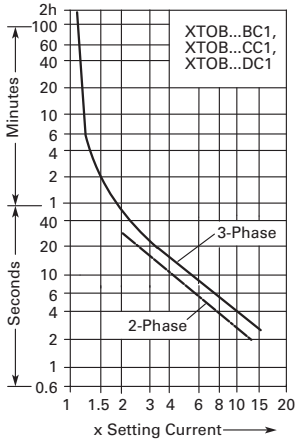

#### XTOB...GC1

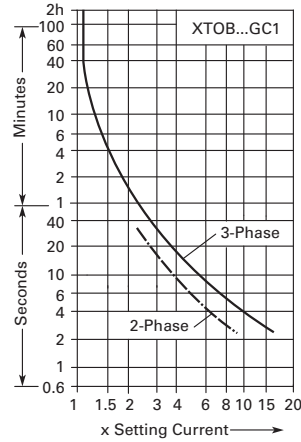

#### XTOB...HC1, XTOB...LC1

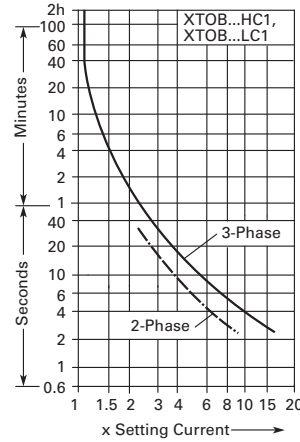

#### Dimensions

Approximate Dimensions in mm [in]

#### Frames B-C, XTOB...BC1 and XTOB...CC1 Overload Relays

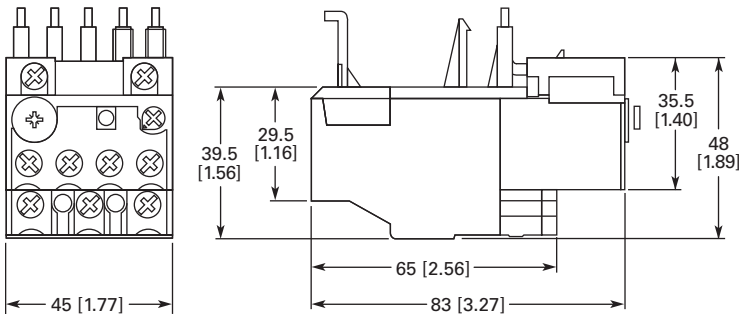

#### Frame D, XTOB...DC1 Overload Relay

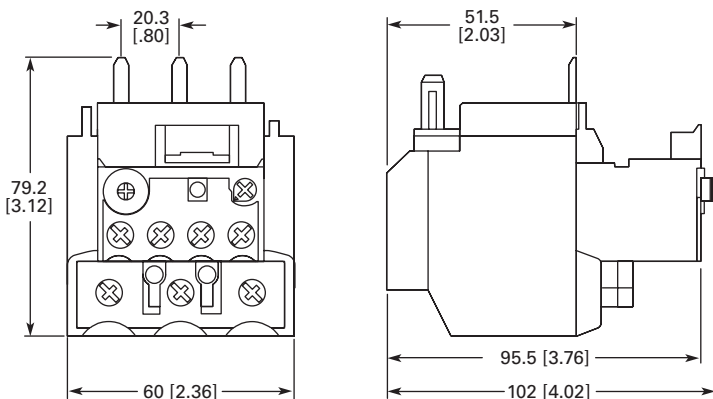

Approximate Dimensions in mm [in]

**Frames B–C, XTOBXDINC DIN Rail or Panel Mount Adapter and Frame D, XTOBXDIND DIN Rail or Panel Mount Adapter**

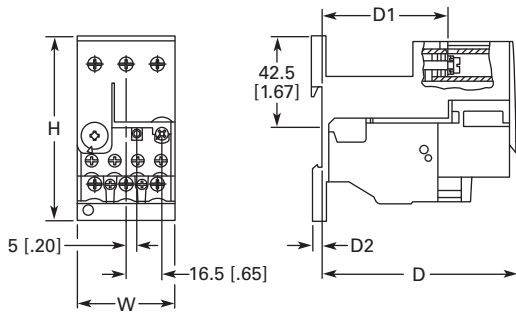

	H	W	D	D1	D2
<b>XTOB...CC1</b>	85 [3.46]	45 [1.77]	90.5 [3.56]	58.3 [2.30]	3.8 [.15]
<b>XTOB...DC1</b>	86 [3.39]	60 [2.36]	112 [4.41]	80.5 [3.17]	4.7 [.19]

**Frames F–G, XTOB...GC1 Overload Relay**

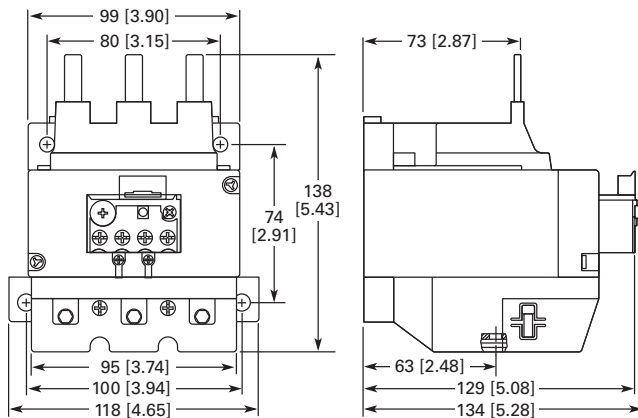

**Frames F–G, XTOB...G1CS Overload Relay**

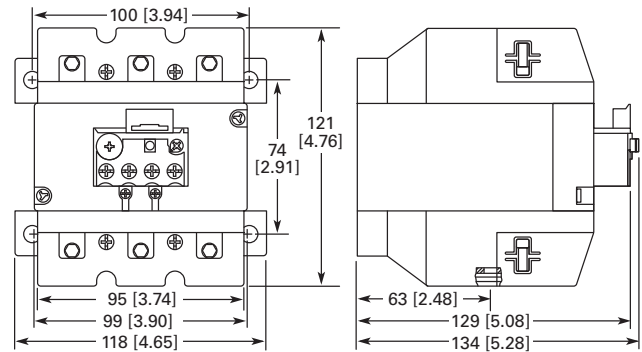

1

Approximate Dimensions in mm [in]

#### Frames L and H, XTOB...LC1, HC1 Overload Relay

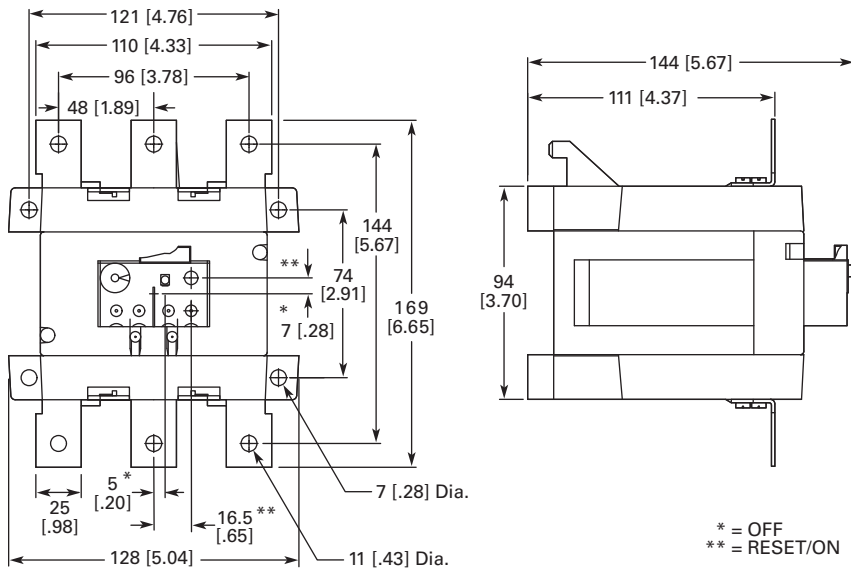

#### XTOT...C3S Current Transformer Operated Overload Relay

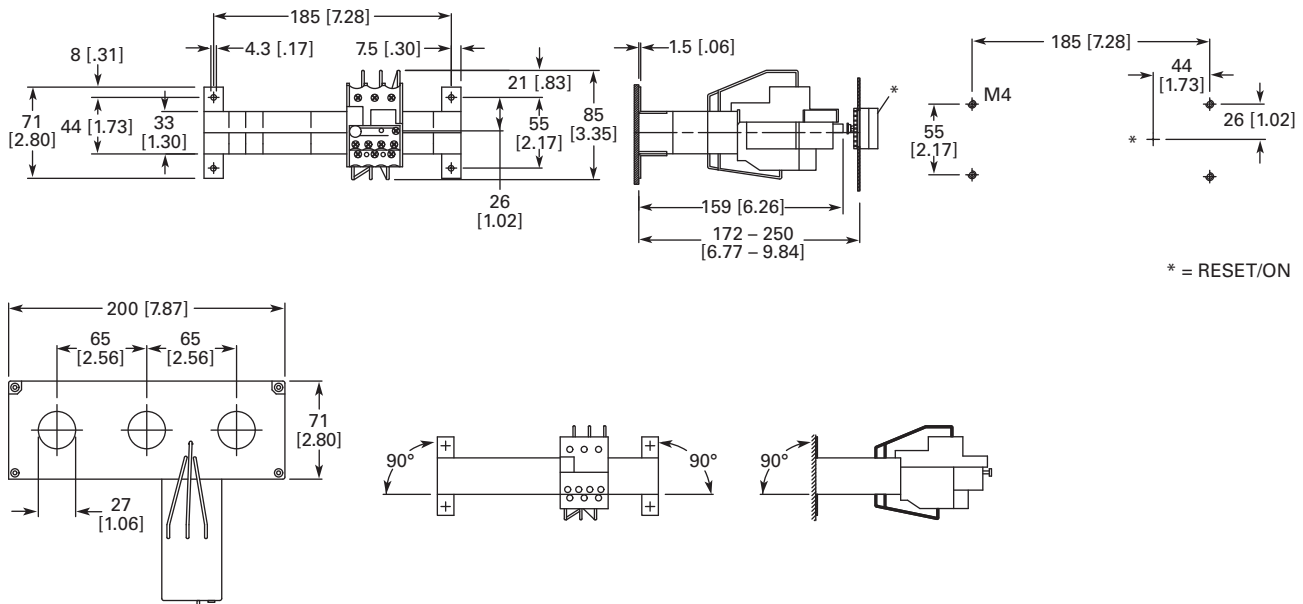

C440/XT Electronic Overload Relay



## C440/XT Electronic Overload Relay

### Product Description

Eaton's new electronic overload relay (EOL) is the most compact, high-featured, economical product in its class. Designed on a global platform, the new EOL covers the entire power control spectrum including NEMA, IEC and DP contactors. The NEMA and DP versions are offered with the *C440* designation while the IEC offering has the **XT** designation. The electronic design provides reliable, accurate and value driven protection and communications capabilities in a single compact device. It is the flexible choice for any application requiring easy-to-use, reliable protection.

Eaton has a long history of innovations and product development in motor control and protection, including both traditional NEMA, as well as IEC control. It was from this experience that the C440 was developed, delivering new solutions to meet today's demands.

C440 is a self-powered electronic overload relay available up to 175A as a self contained unit. With external CTs, C440 can protect motor up to 1500 FLA. Available add-on accessories include remote reset capability and communication modules with I/O for DeviceNet, PROFIBUS, and Modbus.

## Contents

### Description

	<i>Page</i>
Relays and Timers .....	<b>V5-T1-3</b>
Miniature Controls .....	<b>V5-T1-18</b>
Contactors and Starters .....	<b>V5-T1-35</b>
Thermal Overload Relays .....	<b>V5-T1-128</b>
C440/ <b>XT</b> Electronic Overload Relay	
Standards and Certifications .....	<b>V5-T1-142</b>
Catalog Number Selection .....	<b>V5-T1-143</b>
Product Selection .....	<b>V5-T1-144</b>
Accessories .....	<b>V5-T1-146</b>
Technical Data and Specifications .....	<b>V5-T1-149</b>
Dimensions .....	<b>V5-T1-155</b>
 An Eaton Green Solution	
Manual Motor Protectors .....	<b>V5-T1-157</b>
Combination Motor Controllers .....	<b>V5-T1-193</b>
<b>XT</b> Electronic Manual Motor Protector .....	<b>V5-T1-216</b>
Reference Data .....	<b>V5-T1-229</b>

## Features and Benefits

### Features

- Reliable, accurate, electronic motor protection
- Easy to select, install and maintain
- Compact size
- Flexible, intelligent design
- Global product offering—available with NEMA, IEC and DP power control

### Size/Range

- Broad FLA range (0.33–1500A)
- Selectable trip class (10A, 10, 20, 30)
- Direct mounting to NEMA, IEC and DP contactors
- Most compact electronic overload in its class

### Motor Control

- Two B600 alarm (NO) and fault (NC) contacts
- Test/Trip button

### Motor Protection

- Thermal overload
- Phase loss
- Selectable (ON/OFF) phase unbalance
- Selectable (ON/OFF) ground fault

### User Interface

- Large FLA selection dial
- Trip status indicator
- Operating mode LED
- DIP switch selectable trip class, phase unbalance and ground fault
- Selectable Auto/Manual reset

### Feature Options

- Remote reset
  - 120 Vac
  - 24 Vac
  - 24 Vdc
- Tamper-proof cover
- Communications modules
  - Modbus RTU RS-485
  - DeviceNet with I/O
  - PROFIBUS with I/O
  - Modbus RTU with I/O
  - Ethernet IP with I/O
  - Modbus TCP with I/O

#### Benefits

##### Reliability and Improved Uptime

- C440 provides the users with peace of mind knowing that their assets are protected with the highest level of motor protection and communication capability in its class
- Extends the life of plant assets with selectable motor protection features such as trip class, phase unbalance and ground fault
- Protects against unnecessary downtime by discovering changes in your system (line/load) with remote monitoring capabilities
- Status LED provides added assurance that valuable assets are protected by indicating the overload operational status

##### Flexibility

- Available with NEMA, IEC and DP contactors
- Improves return on investment by reducing inventory carrying costs with wide FLA adjustment (5:1) and selectable trip class
- Design incorporates built-in ground fault protection thus eliminating the need for separate CTs and modules
- Flexible communication with optional I/O enables easy integration into plant management systems for remote monitoring and control
- Available as an open component and in enclosed control and motor control center assemblies

##### Monitoring Capabilities

- Individual phase currents RMS
- Average three-phase current RMS
- Thermal memory
- Fault indication (overload, phase loss, phase unbalance, ground fault)

##### Safety

- IP 20 rated terminal blocks
- Available in Eaton's industry leading FlashGard MCCs
- Tested to the highest industry standards such as UL, CSA, CE and IEC
- RoHS compliant

#### Standards and Certifications

- UL
- CSA
- CE
- NEMA
- IEC/EN 60947 VDE 0660
- ISO 13849-1 (EN954-1)
- RoHS
- ATEX directive 94/9/EC
- Equipment Group 2, Category 2



#### Electronic Overload Education

Description	Definition	Cause	Effect if not Protected	C440/XT Protection
<b>Motor Protection</b>				
Thermal overload	Overload is a condition in which current draw exceeds 115% of the full load amperage rating for an inductive motor.	<ul style="list-style-type: none"> <li>• An increase in the load or torque that is being driven by the motor.</li> <li>• A low voltage supply to the motor causes the current to go high to maintain the power needed.</li> <li>• A poor power factor causing above normal current draw.</li> </ul>	<ul style="list-style-type: none"> <li>• Increase in current draw leads to heat and insulation breakdown, which can cause system failure.</li> <li>• Increase in current can increase power consumption and waste valuable energy.</li> </ul>	<ul style="list-style-type: none"> <li>• Thermal trip behavior is defined by UL, CSA and IEC standards.</li> <li>• Trip class is settable from 10A, 10, 20, 30</li> </ul>
Ground fault	A line to ground fault.	A current leakage path to ground.	An undetected ground fault can burn through multiple insulation windings, ultimately leading to motor failure, not to mention risk to equipment or personnel	Fixed protective setting that takes the starter offline if ground fault current exceeds 50% of the FLA dial setting, that is, if the FLA dial is set to 12A, the overload relay will trip if the ground current exceeds 6A.
Unbalanced phases (voltage and current)	Uneven voltage or current between phases in a three-phase system.	When a three-phase load is powered with a poor quality line, the voltage per phase may be unbalanced.	Unbalanced voltage causes large unbalanced currents and as a result this can lead to motor stator windings being overloaded, causing excessive heating, reduced motor efficiency and reduced insulation life.	Fixed protective setting that takes the starter offline if a phase drops below 50% of the other two phases.
Phase loss—current (single-phasing)	One of the three-phase voltages is not present.	Multiple causes, loose wire, improper wiring, grounded phase, open fuse, etc.	Single-phasing can lead to unwanted motor vibrations in addition to the results of unbalanced phases as listed above.	Fixed protective setting that takes the starter offline if a phase is lost.

**Catalog Number Selection**

**XT Electronic Overload Relay—IEC ①**

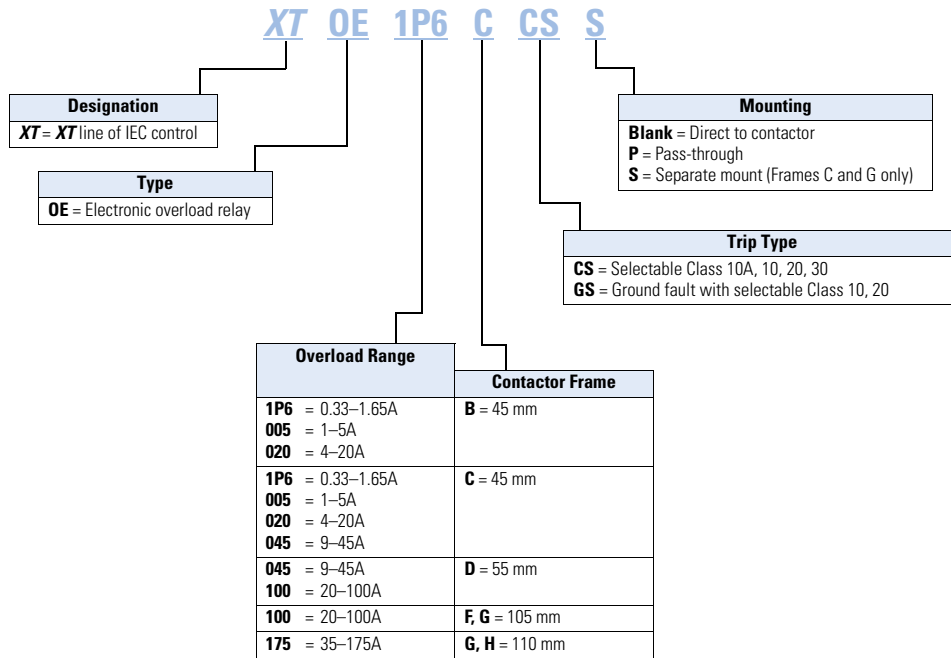

**Note**

① See Page V5-T1-144 for Product Selection.

## Product Selection

### XT Electronic Overload Relays

45 mm XT for Direct Mount



#### XT Electronic Overload Relays for Direct Mount to XT Contactors

For Use with XT Contactor Frame	For Use with Contactor	Overload Range (Amps)	Contact Sequence	Frame Size	Auxiliary Contact Configuration	Type	Catalog Number
B	XTCE007B..., XTCE009B..., XTCE012B..., XTCE015B...	0.33–1.65		45 mm	NO-NC	ZEB12-1,65	<b>XTOE1P6BCS</b>
		1–5		ZEB12-5		<b>XTOE005BCS</b>	
		4–20		ZEB12-20		<b>XTOE020BCS</b>	
C	XTCE018C..., XTCE025C..., XTCE032C	0.33–1.65		45 mm	NO-NC	ZEB32-1,65	<b>XTOE1P6CCS</b>
		1–5		ZEB32-5		<b>XTOE005CCS</b>	
		4–20		ZEB32-20		<b>XTOE020CCS</b>	
		9–45		ZEB32-45		<b>XTOE045CCS</b>	
D	XTCE040D..., XTCE050D..., XTCE065D..., XTCE072D...	9–45		45 mm	NO-NC	ZEB65-45	<b>XTOE045DCS</b>
		20–100		55 mm		ZEB65-100	<b>XTOE100DCS</b>
F	XTCE080F..., XTCE095F...	20–100		55 mm	NO-NC	ZEB150-100	<b>XTOE100GCS</b>
G	XTCE115G..., XTCE150G..., XTCE170G...	20–100		55 mm	NO-NC	ZEB150-100	<b>XTOE100GCS</b>
		35–175		110 mm		ZEB150-175	<b>XTOE175GCS</b>
H	XTCE185H...	35–175		110 mm	NO-NC	ZEB225-175	<b>XTOE175HCS</b>

45 mm XT for Direct Mount with Ground Fault



#### XT Electronic Overload Relays with Ground Fault for Direct Mount to XT Contactors

For Use with XT Contactor Frame	For Use with Contactor	Overload Range (Amps)	Contact Sequence	Frame Size	Auxiliary Contact Configuration	Type	Catalog Number
B	XTCE007B..., XTCE009B..., XTCE012B..., XTCE015B...	0.33–1.65		45 mm	NO-NC	ZEB12-1,65-GF	<b>XTOE1P6BGS</b>
		1–5		ZEB12-5-GF		<b>XTOE005BGS</b>	
		4–20		ZEB12-20-GF		<b>XTOE020BGS</b>	
C	XTCE018C..., XTCE025C..., XTCE032C	0.33–1.65		45 mm	NO-NC	ZEB32-1,65-GF	<b>XTOE1P6CGS</b>
		1–5		ZEB32-5-GF		<b>XTOE005CGS</b>	
		4–20		ZEB32-20-GF		<b>XTOE020CGS</b>	
		9–45		ZEB32-45-GF		<b>XTOE045CGS</b>	
D	XTCE040D..., XTCE050D..., XTCE065D..., XTCE072D...	9–45		45 mm	NO-NC	ZEB65-45-GF	<b>XTOE045DGS</b>
		20–100		55 mm		ZEB65-100-GF	<b>XTOE100DGS</b>
F	XTCE080F..., XTCE095F...	20–100		55 mm	NO-NC	ZEB150-100-GF	<b>XTOE100GGS</b>
G	XTCE115G..., XTCE150G..., XTCE170G...	20–100		55 mm	NO-NC	ZEB150-100-GF	<b>XTOE100GGS</b>
		35–175		110 mm		ZEB150-175-GF	<b>XTOE175GGS</b>
H	XTCE185H...	35–175		110 mm	NO-NC	ZEB225-175-GF	<b>XTOE175HGS</b>



1-5A OL with CTs



**XT Electronic Overload Relays for use with Large Frame XT Contactors (L-R)**

Use CTs and 1-5A **XT** overload relay. CT kit does not include overload relay (order separately).

XT Contactor Frame	For Use with IEC Contactor Amp Range (AC-3)	CT Range (Amps)	Description	CT Kit Catalog Number	Terminal Size	Overload Relay Catalog Number	Overload Relay with Ground Fault Catalog Number
L, M	185–500A	60-300	300: 5 panel-mount CT kit with integrated lugs	ZEB-XCT300	750 kcmil (2) 250 kcmil 3/0 Cu/Al	XTOE005CCSS	XTOE005CGSS
M, N	300–820A	120-600	600: 5 panel-mount CT kit with integrated, pass through holes	ZEB-XCT600	(2) 750 kcmil 3/0 Cu/Al	XTOE005CCSS	XTOE005CGSS
N	580–1000A	200-1000	1000: 5 panel-mount CT kit with integrated, pass through holes	ZEB-XCT1000	(3) 750 kcmil 3/0 Cu/Al	XTOE005CCSS	XTOE005CGSS
R	1600A	300-1500	1500: 5 panel-mount CT kit with integrated, pass through holes	ZEB-XCT1500	(4) 750 kcmil 1/0 Cu/Al	XTOE005CCSS	XTOE005CGSS

45 mm XT for Separate Mount



**XT Electronic Overload Relays for Separate Mount**

Overload Range (Amps)	Frame Size	Contact Sequence	Type	Overload Relay Catalog Number	Overload Relay with Ground Fault Catalog Number
<b>Overload Relay</b>					
0.33–1.65	45 mm	1 3 5 97 95	ZEB32-1,65/KK	XTOE1P6CCSS	XTOE1P6CGSS
1–5			ZEB32-5/KK	XTOE005CCSS	XTOE005CGSS
4–20		2 4 6 98 96	ZEB32-20/KK	XTOE020CCSS	XTOE020CGSS
9–45			ZEB32-45/KK	XTOE045CCSS	XTOE045CGSS
20–100	55 mm		ZEB150-100/KK	XTOE100GCSS	XTOE100GGSS
35–175	110 mm		ZEB150-175/KK	XTOE175GCSS	XTOE175GGSS

**XT Electronic Overload Relay for Pass-Through Design**



Pass-through design does not include any lugs to land wires. Terminate motor leads directly on contactor.

Overload Range (Amps)	Frame Size	Contact Sequence	Type	Overload Relay Catalog Number	Overload Relay with Ground Fault Catalog Number
35–175	110 mm	1 3 5 97 95 	ZEB150-175/PT	XTOE175GCSP	XTOE175GGSP

## Accessories

### CT Kits

#### Accessories

	Description	Catalog Number
 <p><b>Safety Cover</b></p>	<p><b>Safety Cover</b></p> <p>Clear Lexan cover that mounts on top of the FLA dial and DIP switches when closed.</p>	<b>ZEB-XSC</b>
 <p><b>Reset Bar</b></p>	<p><b>Reset Bar</b></p> <p>Assembles to the top of the overload to provide a larger target area for door mounted reset operators.</p>	<b>ZEB-XRB</b>
 <p><b>Remote Reset</b></p>	<p><b>Remote Reset</b></p> <p>Remote reset module (24 Vdc) ①</p> <p>Remote reset module (120 Vac) ①</p> <p>Remote reset module (24 Vac) ①</p>	<p><b>C440-XCOM</b></p> <p><b>ZEB-XRR-120</b></p> <p><b>ZEB-XRR-24</b></p>

### Communication

The C440 is provided with two levels of communication capability.

#### Basic Communication via Expansion Module—Monitoring Only

Basic communication on the C440 is accomplished using an expansion module. The expansion module plugs into the expansion bay on the C440 overload relay, enabling communications with the overload via their Modbus RTU (RS-485) network. No additional parts are required. See figure below.



**Basic Communication—Modbus**

#### Advanced Communication—Monitoring and Control

C440 also has the ability to communicate on industrial protocols such as DeviceNet, PROFIBUS, Modbus RTU and Modbus TCP, and Ethernet (planned) while providing control capability using I/O.

An expansion module (mentioned earlier) combined with a communication adapter and a communication module allows easy integration onto the customer's network. See figure below.



**Advanced Communication—Communication Adapter with Communication Module**

#### Advanced Communication—Communication Module

The communication adapter comes standard with four inputs and two outputs (24 Vdc or 120 Vac) while providing the customer with flexible mounting options (DIN rail or panel). See figure below,



#### Note

① Customer can wire remote mounted button to reset module (that is, 22 mm pushbutton, catalog number M22-D-B-GB14-K10).

The following information can be viewed using the communication option:

- Motor status—running, stopped, tripped or resetting
- Individual rms phase currents (A, B, C)
- Average of three-phase rms current
- Percent thermal capacity
- Fault codes (only available prior to reset)
- Percent phase unbalance
- Ground fault current and percent
- Overload relay settings—trip class, DIP switch selections, reset selections
- Modbus address (can be set over the network)

### Communication Accessories

	Description	Catalog Number
<b>Expansion Module</b> 	Expansion module (Remote Reset/Modbus RTU, RS-485 Communication)	<b>C440-XCOM</b>
<b>Communication Adapter</b> 	Communication adapter kit (DIN C Panel mounted adapter, required for advance communication option)	<b>C440-COM-ADP</b>
	DeviceNet communication module kit—120V I/O (consists of C440-XCOM + C441K + C440-COM-ADP)	<b>C440-DN-120</b>
	DeviceNet communication module kit—24 Vdc I/O (consists of C440-XCOM + C441L + C440-COM-ADP)	<b>C440-DN-24</b>
	PROFIBUS communication module kit—120V I/O (consists of C440-XCOM + C441S + C440-COM-ADP)	<b>C440-DP-120</b>
	PROFIBUS communication module kit—24V I/O (consists of C440-XCOM + C441Q + C440-COM-ADP)	<b>C440-DP-24</b>
	Modbus communication module kit—120V I/O (consists of C440-XCOM + C441N + C440-COM-ADP)	<b>C440-MOD-120</b>
	Modbus communication module kit—24 Vdc I/O (consists of C440-XCOM + C441P + C440-COM-ADP)	<b>C440-MOD-24</b>
	Modbus TCP/Ethernet IP communication module kit—120V I/O (consists of C440-XCOM + C441U)	<b>C440-ET-120</b>
	Modbus TCP/Ethernet IP communication module kit—24V I/O (consists of C440-XCOM + C441V)	<b>C440-ET-24</b>

**Modbus Communication Module**

The Modbus module combined with an expansion module and a communication adapter provide Modbus communication capability to the C440 electronic overload relay.



**Modbus  
Communication Module**

**Features and Benefits**

- The Modbus communication module is capable of baud rates up to 115K
- The Modbus address and baud rate configuration can be easily changed using the HMI user interface
- Modbus address and baud rate are set via convenient DIP switches; LEDs are provided to display Modbus traffic
- Configuration with common Modbus configuration tools
- Terminals
  - Unique locking mechanism provides for easy removal of the terminal block with the field wiring installed
  - Each terminal is marked for ease of wiring and troubleshooting
- Selectable I/O assemblies
  - 4IN/2OUT
  - Signal types include 24 Vdc I/O and 120 Vac I/O
- Each I/O module is optically isolated between the field I/O and the network adapter to protect the I/O and communication circuits from possible damage due to transients and ground loops
- Input Module features a user-definable input debounce, which limits the effects of transients and electrical noise
- Output Module supports a user-definable safe state for loss of communication; hold last state, ON or OFF

**DeviceNet Communication Modules**

The DeviceNet Communication Module provides monitoring and control for the C440 overload relay from a single DeviceNet node. These modules also offer convenient I/O in two voltage options, 24 Vdc and 120 Vac.



**DeviceNet  
Communication Module**

**Features and Benefits**

- Communication to DeviceNet uses only one DeviceNet MAC ID
- Configuration
  - DeviceNet MAC ID and Baud rate are set via convenient DIP switches with an option to set from the network
  - Advanced configuration available using common DeviceNet tools
- Terminals
  - Unique locking mechanism provides for easy removal of the terminal block with the field wiring installed
  - Each terminal is marked for ease of wiring and troubleshooting
- Selectable I/O assemblies
  - 4IN/2OUT
  - Signal types include 24 Vdc I/O and 120 Vac I/O
- Each I/O module is optically isolated between the field I/O and the network adapter to protect the I/O and communication circuits from possible damage due to transients and ground loops
- Input Module features a user-definable input debounce, which limits the effects of transients and electrical noise
- Output Module supports a user-definable safe state for loss of communication; hold last state, ON or OFF

**PROFIBUS Communication Modules**

The PROFIBUS module combined with an expansion module and a communication adapter provide Modbus communication capability to the C440 electronic overload relay.



**PROFIBUS  
Communication Module**

**Features and Benefits**

- The PROFIBUS communication module is capable of baud rates up to 12 Mb
- PROFIBUS address is set via convenient DIP switches; LEDs are provided to display PROFIBUS status
- Intuitive configuration with common PROFIBUS configuration tools
- Terminals
  - Unique locking mechanism provides for easy removal of the terminal block with the field wiring installed
  - Each terminal is marked for ease of wiring and troubleshooting
- Selectable I/O assemblies
  - 4IN/2OUT
  - Signal types include 24 Vdc I/O and 120 Vac I/O
- Each I/O module is optically isolated between the field I/O and the network adapter to protect the I/O and communication circuits from possible damage due to transients and ground loops
- Input Module features a user-definable input debounce, which limits the effects of transients and electrical noise
- Output Module supports a user-definable safe state for loss of communication; hold last state, ON or OFF

## Technical Data and Specifications

### Electronic Overload Relays up to 1500A

Description	Specification		
	45 mm	55 mm	110 mm
<b>Electrical Ratings</b>	<b>Range</b>	<b>Range</b>	<b>Range</b>
Operating voltage (three-phase) and frequency	690 Vac (60/50 Hz)	690 Vac (60/50 Hz)	690 Vac (60/50 Hz)
<b>FLA Range</b>			
	0.33–1.65A 1–5A 4–20A 9–45A	20–100A	28–140A (NEMA) 35–175A (IEC)
<b>Use with Contactors</b>			
XT IEC frames	B, C, D	F, G	G, H
Freedom NEMA sizes	00, 0, 1, 2	3	4
<b>Trip Class</b>			
	10A, 10, 20, 30 Selectable	10A, 10, 20, 30 Selectable	10A, 10, 20, 30 Selectable
<b>Motor Protection</b>			
Thermal overload setting	1.05 x FLA: does not trip 1.15 x FLA: overload trip	1.05 x FLA: does not trip 1.15 x FLA: overload trip	1.05 x FLA: does not trip 1.15 x FLA: overload trip
<b>Feature</b>	<b>Range</b>	<b>Range</b>	<b>Range</b>
Phase loss	Fixed threshold 50%	Fixed threshold 50%	Fixed threshold 50%
Phase unbalance (selectable: enable/disable)	Fixed threshold 50%	Fixed threshold 50%	Fixed threshold 50%
Ground fault (selectable: enable/disable)	50% of FLA dial setting >150% = 2 sec >250% = 1 sec	50% of FLA dial setting >150% = 2 sec >250% = 1 sec	50% of FLA dial setting >150% = 2 sec >250% = 1 sec
Reset	Manual/automatic	Manual/automatic	Manual/automatic
<b>Indicators</b>			
Trip status	Orange flag	Orange flag	Orange flag
Mode LED	One flash: Overload operating properly Two flashes: Current is above FLA dial setting—pending trip	One flash: Overload operating properly Two flashes: Current is above FLA dial setting—pending trip	One flash: Overload operating properly Two flashes: Current is above FLA dial setting—pending trip
<b>Options</b>			
Remote reset	Yes	Yes	Yes
Reset bar	Yes	Yes	Yes
Communication expansion module	Yes	Yes	Yes
Communication adapter	Yes	Yes	Yes
<b>Capacity</b>			
Load terminals			
Terminal capacity	12–10 AWG (4–6 mm <sup>2</sup> ) 8–6 AWG (6–16 mm <sup>2</sup> )	6–1 AWG (16–50 mm <sup>2</sup> )	8–4/0 AWG (10–95 mm <sup>2</sup> )
Tightening torque	20–25 lb-in (2.3–2.8 Nm) 25–30 lb-in (2.8–3.4 Nm)	25–30 lb-in (2.8–3.4 Nm)	124 lb-in (14 Nm)
Input, auxiliary contact and remote reset terminals			
Terminal capacity	2 x (18–12) AWG	2 x (18–12) AWG	2 x (18–12) AWG
Tightening torque	7–11 lb-in (0.8–1.2 Nm)	7–11 lb-in (0.8–1.2 Nm)	7–11 lb-in (0.8–1.2 Nm)
<b>Voltages</b>			
Insulation voltage U <sub>i</sub> (three-phase)	690 Vac	690 Vac	690 Vac
Insulation voltage U <sub>i</sub> (control)	500 Vac	500 Vac	500 Vac
Rated impulse withstand voltage	6000 Vac	6000 Vac	6000 Vac
Overvoltage category/pollution degree	III/3	III/3	III/3

## Electronic Overload Relays up to 1500A, continued

Description	Specification		
	45 mm	55 mm	110 mm
<b>Auxiliary and Control Circuit Ratings</b>			
Conventional thermal continuous current	5A	5A	5A
Rated operational current—IEC AC-15			
Make contact (1800 VA)			
120V	15A	15A	15A
240V	15A	15A	15A
415V	0.5A	0.5A	0.5A
500V	0.5A	0.5A	0.5A
Break contact (180 VA)			
120V	1.5A	1.5A	1.5A
240V	1.5A	1.5A	1.5A
415V	0.9A	0.9A	0.9A
500V	0.8A	0.8A	0.8A
IEC DC-13 (L/R F 15 ms1)			
0–250V	1.0A	1.0A	1.0A
Rated operational current—UL B600			
Make contact (3600 VA)			
120V	30A	30A	30A
240V	15A	15A	15A
480V	7.5A	7.5A	7.5A
600V	6A	6A	6A
Break contact (360 VA)			
120V	3A	3A	3A
240V	1.5A	1.5A	1.5A
480V	0.75A	0.75A	0.75A
600V	0.6A	0.6A	0.6A
R300—Vdc ratings (28 VA)			
0–120V	0.22A	0.22A	0.22A
250V	0.11A	0.11A	0.11A
<b>Short-Circuit Rating without Welding</b>			
Maximum fuse	6A gG/gL	6A gG/gL	6A gG/gL
<b>Environmental Ratings</b>			
Ambient temperature (operating)	–13° to 149°F (–25° to 65°C)	–13° to 149°F (–25° to 65°C)	–13° to 149°F (–25° to 65°C)
Ambient temperature (storage)	–40° to 185°F (–40° to 85°C)	–40° to 185°F (–40° to 85°C)	–40° to 185°F (–40° to 85°C)
Operating humidity UL 991 (H3)	5% to 95% non-condensing	5% to 95% non-condensing	5% to 95% non-condensing
Altitude (no derating) NEMA ICS1	2000m	2000m	2000m
Shock (IEC 600068-2-27)	15g any direction	15g any direction	15g any direction
Vibration (IEC 60068-2-6)	3g any direction	3g any direction	3g any direction
Pollution degree per IEC 60947-4-1	3 for product (2 for pcb)	3 for product (2 for pcb)	3 for product (2 for pcb)
Ingress protection	IP20	IP20	IP20
Protection against direct contact when actuated from front (IEC 536)	Finger- and back-of-hand proof	Finger- and back-of-hand proof	Finger- and back-of-hand proof
Mounting position	Any	Any	Any
Climatic proofing	Damp heat, constant to IEC 60068-2-30	Damp heat, constant to IEC 60068-2-30	Damp heat, constant to IEC 60068-2-30

## Electronic Overload Relays up to 1500A, continued

Description	Specification		
	45 mm	55 mm	110 mm
<b>Electrical/EMC</b>			
Radiated emissions IEC 60947-4-1-Table 15 EN 55011 (CISPIR 11) Group 1, Class A, ISM	30 mHz to 1000 mHz	30 mHz to 1000 mHz	30 mHz to 1000 mHz
Conducted emissions IEC 60947-4-1-Table 14 EN 55011 (CISPIR 11) Group 1; Class ISM	0.15 mHz to 30 mHz	0.15 mHz to 30 mHz	0.15 mHz to 30 mHz
ESD immunity IEC 60947-4-1 (Table 13)	±8 kV air, ±6 kV contact	±8 kV air, ±6 kV contact	±8 kV air, ±6 kV contact
Radiated immunity IEC 60947-4-1 IEC 61000-4-3	10 V/m 80 mHz–1000 mHz 3 V/m from 1.4 to 2.7 GHz 80% amplitude modulated 1 kHz sine wave	10 V/m 80 mHz–1000 mHz 3 V/m from 1.4 to 2.7 GHz 80% amplitude modulated 1 kHz sine wave	10 V/m 80 mHz–1000 mHz 3 V/m from 1.4 to 2.7 GHz 80% amplitude modulated 1 kHz sine wave
Conducted immunity IEC 60947-4-1, IEC 61000-4-6	140 dub (10V rms) 150 kHz–100 mHz	140 dub (10V rms) 150 kHz–100 mHz	140 dub (10V rms) 150 kHz–100 mHz
Fast transient immunity IEC 60947-4-1 (Table 13) IEC 61000-4-4	±4 kV using direct method with accessory installed in expansion bay ±2 kV using direct method	±4 kV using direct method with accessory installed in expansion bay ±2 kV using direct method	±4 kV using direct method with accessory installed in expansion bay ±2 kV using direct method
Surge immunity IEC 60947-4-1 (Table 13) IEC 61000-4-5 a Class 4	Three-phase power inputs: ±4 kV line-to-line (DM) ±4 kV line-to-ground (CM)  With accessory installed in expansion bay: ±2 kV line-to-line (DM) →1.2/50 us; 2 kV line-to-earth, 1 kV line-to-line ±4 kV line-to-ground (CM)	Three-phase power inputs: ±4 kV line-to-line (DM) ±4 kV line-to-ground (CM)  With accessory installed in expansion bay: ±2 kV line-to-line (DM) →1.2/50 us; 2 kV line-to-earth, 1 kV line-to-line ±4 kV line-to-ground (CM)	Three-phase power inputs: ±4 kV line-to-line (DM) ±4 kV line-to-ground (CM)  With accessory installed in expansion bay: ±2 kV line-to-line (DM) →1.2/50 us; 2 kV line-to-earth, 1 kV line-to-line ±4 kV line-to-ground (CM)
Power freq. magnetic field immunity IEC 60947-4-1, IEC 61000-4-8	30 A/m, 50 Hz	30 A/m, 50 Hz	30 A/m, 50 Hz
Electromagnetic field IEC 60947-4-1 Table 13, IEC 61000-4-3	10 V/m	10 V/m	10 V/m
Distortion IEEE 519	5% THD max., 5th harmonic 3% max.	5% THD max., 5th harmonic 3% max.	5% THD max., 5th harmonic 3% max.
Electrostatic discharge (ESD) IEC 61000-4-2, EN 61131-2	4 kV contact 8 kV air discharge	4 kV contact 8 kV air discharge	4 kV contact 8 kV air discharge
Electrical fast transient (EFT) IEC 61000-4-4, EN 61131-2	±2 kV using direct method	±2 kV using direct method	±2 kV using direct method
Surge immunity IEC 61000-4-5, EN 61131-2	±2 kV line-to-ground (CM)	±2 kV line-to-ground (CM)	±2 kV line-to-ground (CM)

## Communication Modules

Description	Modbus	DeviceNet	PROFIBUS	Ethernet
<b>Electrical/EMC</b>				
Radiated emissions IEC 60947-4-1—Table 15, EN 55011 (CISPR 11) Group 1, Class A	30–1000 mHz	30–1000 mHz	30–1000 mHz	30–1000 mHz
Conducted emissions IEC 60947-4-1—Table 14, EN 55011 (CISPR 11) Group 1, Class A	0.15–30 mHz	0.15–30 mHz	0.15–30 mHz	0.15–30 mHz
ESD immunity IEC 60947-4-1 (Table 13)	±8 kV air, ±4 kV contact	±8 kV air, ±4 kV contact	±8 kV air, ±4 kV contact	±8 kV air, ±4 kV contact
Radiated immunity IEC 60947-4-1	10 V/m 80–1000 mHz 80% amplitude modulated 1 kHz sine wave	10 V/m 80–1000 mHz 80% amplitude modulated 1 kHz sine wave	10 V/m 80–1000 mHz 80% amplitude modulated 1 kHz sine wave	10 V/m 80–1000 mHz 80% amplitude modulated 1 kHz sine wave
Conducted immunity IEC 60947-4-1	140 dBuV (10V rms) 150 kHz–80 mHz	140 dBuV (10V rms) 150 kHz–80 mHz	140 dBuV (10V rms) 150 kHz–80 mHz	140 dBuV (10V rms) 150 kHz–80 mHz
Fast transient immunity IEC 60947-4-1 (Table 13) IEC 6100-4-4	±2 kV using direct method	±2 kV supply and control, ±1 kV communication	±2 kV supply and control, ±1 kV communication	±2 kV supply and control, ±1 kV communication
Surge immunity IEC 60947-4-1 (Table 13) IEC 61000-4-5 Class 3	User IO and communication lines <sup>①</sup> : ±1 kV line-to-line (DM) ±2 kV line-to-ground (CM)	User IO and communication lines: ±0.5 kV line-to-line (DM) ±1 kV line-to-ground (CM)	User IO and communication lines: ±0.5 kV line-to-line (DM) ±1 kV line-to-ground (CM)	User IO and communication lines: ±0.5 kV line-to-line (DM) ±1 kV line-to-ground (CM)
Electromagnetic field <sup>①</sup> IEC 60947-4-1 (Table 13) IEC 61000-4-3	10 V/m	10 V/m	10 V/m	10 V/m
<b>Environmental Ratings</b>				
Ambient temperature (operating)	–4° to 122°F (–20° to 50°C)	–13° to 122°F (–25° to 50°C)	–13° to 122°F (–25° to 50°C)	–13° to 122°F (–25° to 50°C)
Ambient temperature (storage)	–40° to 185°F (–40° to 85°C)	–40° to 185°F (–40° to 85°C)	–40° to 185°F (–40° to 85°C)	–40° to 185°F (–40° to 85°C)
Operating humidity	5–95% noncondensing	5–95% noncondensing	5–95% noncondensing	5–95% noncondensing
Altitude (no derating)	2000m	2000m	2000m	2000m
Shock (IEC 60068-2-27)	15G any direction	15G any direction	15G any direction	15G any direction
Vibration (IEC 60068-2-6)	3G any direction	3G any direction	3G any direction	3G any direction
Pollution degree per IEC 60947-1	3	3	3	3
Degree of protection	IP20	IP20	IP20	IP20
Overvoltage category per UL 508	III	III	III	III
<b>DeviceNet</b>				
DeviceNet connections	—	Group 2, polling, bit strobe, explicit, no UCMM	—	Group 2, polling, bit strobe, explicit, no UCMM
DeviceNet baud rate	—	125K, 250K, 500K	—	125K, 250K, 500K
<b>Ethernet</b>				
Ethernet connections	—	—	—	Integrated two-port switch with dual RJ45 Ethernet connections
Ethernet type	—	—	—	Ethernet 10/100 Mbs, AutoMDX, Auto Negotiation
<b>PROFIBUS</b>				
PROFIBUS connections	—	—	Group 2, polling, bit strobe, explicit, no UCMM	—
PROFIBUS baud rate	—	—	9.6K, 19.2K, 45.45K, 93.75K, 187.5K, 500K, 1.5M, 3M, 6M, 12M	—

**Note**

<sup>①</sup> Relates to C441M only.



## Communication Modules, continued

Description	Modbus	DeviceNet	PROFIBUS	Ethernet
<b>C441_ 24 Vdc Input</b>				
Nominal input voltage	24 Vdc	24 Vdc	24 Vdc	24 Vdc
Operating voltage	18–30 Vdc	18–30 Vdc	18–30 Vdc	18–30 Vdc
Number of inputs	4	4	4	4
Signal delay	5 ms (programmable to 65 sec)	5 ms (programmable to 65 sec)	5 ms (programmable to 65 sec)	5 ms (programmable to 65 sec)
OFF-state voltage	<6 Vdc	<6 Vdc	<6 Vdc	<6 Vdc
ON-state voltage	>18 Vdc	>18 Vdc	>10 Vdc	>18 Vdc
Nominal input current	5 mA	5 mA	5 mA	5 mA
Isolation	1500V	1500V	1500V	1500V
Terminal screw torque	7–9 in-lb	7–9 in-lb	7–9 in-lb	7–9 in-lb
24V source current	50 mA	50 mA	50 mA	50 mA
<b>Operating Voltage Range—DC Input Modules</b>				
OFF state	0–6 Vdc	0–6 Vdc	0–6 Vdc	0–6 Vdc
Transition region	6–18 Vdc	6–18 Vdc	6–18 Vdc	6–18 Vdc
ON state	18–30 Vdc	18–30 Vdc	18–30 Vdc	18–30 Vdc
<b>C441_ 120 Vac Input</b>				
Nominal input voltage	120 Vac	120 Vac	120 Vac	120 Vac
Operating voltage	80–140 Vac	80–140 Vac	80–140 Vac	80–140 Vac
Number of inputs	4	4	4	4
OFF-state voltage	<30 Vac	<30 Vac	<20 Vac	<30 Vac
ON-state voltage	>80 Vac	>80 Vac	>70 Vac	>80 Vac
Nominal input current	15 mA	15 mA	15 mA	15 mA
Signal delay	1/2 cycle	1/2 cycle	1/2 cycle	1/2 cycle
Isolation	1500V	1500V	1500V	1500V
Terminal screw torque	7–9 in-lb	7–9 in-lb	7–9 in-lb	7–9 in-lb
<b>Operating Voltage Range—AC Input Modules</b>				
OFF state	0–30 Vac	0–30 Vac	0–30 Vac	0–30 Vac
Transition region	30–80 Vac	30–80 Vac	30–80 Vac	30–80 Vac
ON state	80–140 Vac	80–140 Vac	80–140 Vac	80–140 Vac
<b>Output Modules</b>				
Nominal voltage	120 Vac 24 Vdc	120 Vac 24 Vdc	120 Vac 24 Vdc	120 Vac 24 Vdc
Number of outputs	(2) 1NO Form A 1NO/NC Form C	(2) 1NO Form A 1NO/NC Form C	(2) 1NO Form A 1NO/NC Form C	(2) 1NO Form A 1NO/NC Form C
Relay OFF time	3 ms	3 ms	3 ms	3 ms
Relay ON time	7 ms	7 ms	7 ms	7 ms
Max. current per point <sup>①</sup>	5A (B300 rated)	5A (B300 rated)	5A (B300 rated)	5A (B300 rated)
Electrical life	100,000 cycles	100,000 cycles	100,000 cycles	100,000 cycles
Mechanical life	1,000,000 cycles	1,000,000 cycles	1,000,000 cycles	1,000,000 cycles

**Note**

<sup>①</sup> Relates to C441M only.

**Short Circuit Ratings (North America CSA, cUL)**

Changes to UL 508A and NEC in recent years have brought a focus to control panel safety with regard to short-circuit current ratings (SCCR). Eaton's C440 electronic overload relays combined with **XT** series IEC and Freedom Series NEMA contactors provide a wide variety of SCCR solutions needed for a variety of applications. The SCCR data in this document reflects the latest information as of April 2010.

**C440/XT Standalone Overload Relays (XT, C440)**

Overload FLA Range	Maximum Operating Voltage	Standard-Fault Short Circuit Data			High-Fault Short Circuit Data Fuses (RK5, J, CC)			Thermal-Magnetic Circuit Breakers		
		600V (kA)	Maximum Fuse Size (A) (RK5)	Maximum Breaker Size (A)	480V (kA)	600V (kA)	Maximum Fuse Size	480V (kA)	600V (kA)	Maximum Breaker Size
0.33–1.65A	600 Vac	1	6	15	—	—	—	—	—	—
1–5A	600 Vac	5	20	20	100	100	30	100	35	20
4–20A	600 Vac	5	80	80	100	100	100	100	35	80
9–45A	600 Vac	5	175	175	100	100	100	100	35	100/175 (480/600)
20–100A	600 Vac	10	400	400	100	100	200	150	35	250/400 (480/600)
28–140A	600 Vac	10	450	500	100	100	400	100	65	400
35–175A	690 Vac	10	500 (gG)	350 (690 Vac) 320 (415 Vac)	100	100	500 (gG)	100 (415 Vac)	—	350 (LGC3350) 320 (N2MH3)

**IEC XT Starters with XT Electronic Overload Relays**

Contactor Frame Size	Maximum Operating Voltage	High-Fault Short Circuit Data Fuses (RK5, J, CC)			Thermal-Magnetic Circuit Breakers		
		480V	600V	Maximum Fuse Size	480V	600V	Maximum Breaker Size
B	1–5A	100	100	30	—	—	—
	4–20A	100	100	30	—	—	—
C	1–5A	100	100	60	—	—	—
	4–20A	100	100	60	—	—	—
	9–45A	100	100	60	—	—	—
D	9–45A	100	100	200	65	35	175
	20–100A	100	100	200	65	35	175
F	20–100A	100	100	200	65	65	350
G	20–100A	100	100	200	65	65	350
	35–175A	100	100	400	65	30	250 (480 Vac) 350 (600 Vac)
H	35–175A	100	100	400	65	30	400

**Dimensions**

Approximate Dimensions in Inches (mm)

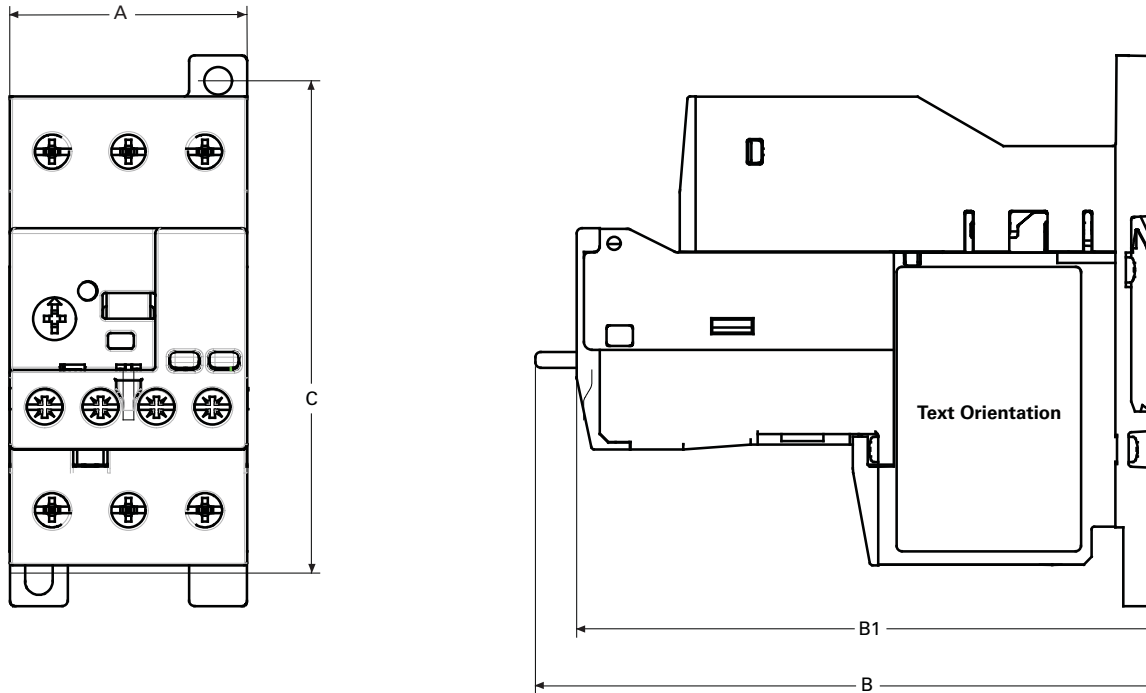
**45 mm C440/XT Electronic Overload Relays**

	Width A	Depth B1	B	Mounting Holes (Height) C
<b>NEMA Starter Size</b>				
00-2	1.80 (45.7)	4.32 (109.7)	4.63 (117.5)	3.68 (93.5)
<b>XTIEC Frame Size</b>				
B, C, D	1.80 (45.7)	4.00 (101.6)	4.30 (109.2)	3.68 (93.5)
<b>Standalone</b>				
0.35-45A	1.80 (45.7)	4.30 (109.2)	4.60 (116.8)	3.68 (93.5)

# 1.1

## IEC Contactors and Starters

### XT IEC Power Control

1

Approximate Dimensions in Inches (mm)

#### 55 mm C440/XT Electronic Overload Relays

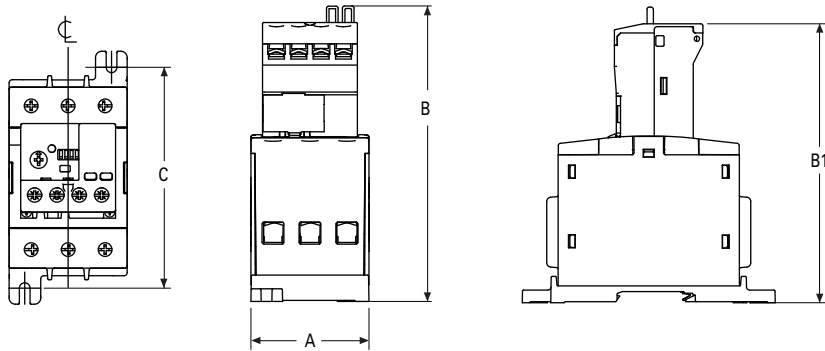

	Width A	Height To Reset B	B1	Mounting Depth C
<b>NEMA Starter Size</b>				
3	2.21 (56.0)	5.52 (140.2)	5.21 (132.4)	4.13 (104.8)
<b>XTIEC Frame Size</b>				
D, F, G	2.21 (56.0)	5.52 (140.2)	5.21 (132.4)	4.13 (104.8)
<b>Standalone</b>				
20–100A	2.21 (56.0)	5.52 (140.2)	5.21 (132.4)	4.13 (104.8)

#### 110 mm C440/XT Electronic Overload Relays

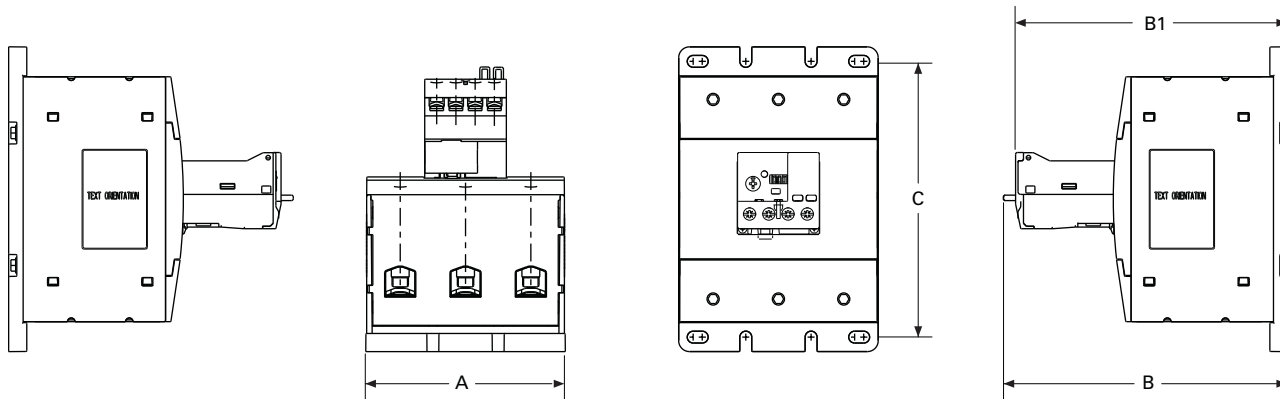

	Width A	Height To Reset B	B1	Mounting Depth C
<b>NEMA Starter Size</b>				
4	4.33 (110.0)	6.20 (157.0)	5.90 (150.0)	6.00 (152.0)
<b>XTIEC Frame Size</b>				
G	4.33 (110.0)	6.20 (157.0)	5.90 (150.0)	6.00 (152.0)
H	4.33 (110.0)	6.20 (157.0)	5.90 (150.0)	6.00 (152.0)
<b>Standalone</b>				
	4.33 (110.0)	6.20 (157.0)	5.90 (150.0)	6.00 (152.0)
<b>Pass-Through</b>				
	4.33 (110.0)	5.90 (149.0)	5.60 (142.0)	4.00 (102.0)

## Manual Motor Protectors



## Manual Motor Protectors

## Product Description

Eaton's new **XT** family of manual motor protectors (MMPs) features a pushbutton or rotary ON/OFF manual disconnect, Class 10 adjustable bimetallic overload relay and fixed magnetic short-circuit trip capability in one compact unit. Two frame sizes are available: Frame B (45 mm) for motors with FLA ratings up to 32A and Frame D (55 mm) covers motor FLA ratings up to 65A.

## Application Description

The XTPB and XTPR MMPs can be used in the following applications.

**Motor Protective Circuit Breaker**

In many countries outside of the United States and Canada, especially Europe, the MMPs are tested and classified as thermal-magnetic circuit breakers for use in motor branch circuits. This can be an important consideration for all companies who export their equipment and machines internationally. Both the XTPB and XTPR conform to IEC/EN 60947 and have the CE Mark.

**Manual Motor Protectors**

The XTPB and XTPR MMPs are UL listed under UL 508 as manual motor protectors. They provide an economical solution for applications requiring simple manual starting and stopping of motors. When used as a manual starter, they are typically installed in an enclosure. Many enclosures are offered as accessories for the MMPs. Separate short-circuit protective devices, such as circuit breakers or fuses, are wired ahead of the MMPs. The short-circuit protective device should be sized per the NEC and should not exceed 400% of the maximum FLA dial setting of the MMP.

## Contents

<b>Description</b>	<b>Page</b>
Relays and Timers .....	<b>V5-T1-3</b>
Miniature Controls .....	<b>V5-T1-18</b>
Contactors and Starters .....	<b>V5-T1-35</b>
Thermal Overload Relays .....	<b>V5-T1-128</b>
C440/ <b>XT</b> Electronic Overload Relay .....	<b>V5-T1-141</b>
Manual Motor Protectors	
Features and Benefits .....	<b>V5-T1-158</b>
Standards and Certifications .....	<b>V5-T1-158</b>
Product Identification .....	<b>V5-T1-159</b>
Catalog Number Selection .....	<b>V5-T1-160</b>
Product Selection .....	<b>V5-T1-161</b>
Accessories .....	<b>V5-T1-164</b>
Technical Data and Specifications .....	<b>V5-T1-176</b>
Dimensions .....	<b>V5-T1-185</b>
Combination Motor Controllers .....	<b>V5-T1-193</b>
<b>XT</b> Electronic Manual Motor Protector .....	<b>V5-T1-216</b>
Reference Data .....	<b>V5-T1-229</b>

**Group Motor Installations**

A group motor installation can be defined as more than one motor circuit protected by a single set of fuses or circuit breaker on a motor branch circuit. This eliminates the need for individual fuses or circuit breakers for each motor circuit. Substantial component cost savings, panel space savings and reduced wiring installation time can be achieved in group motor installations.

The MMPs are tested and listed for group installation. If remote operation is required, a magnetic contactor can be wired in series with the MMP.

Article 430.53 of the NEC contains the rules and requirements for group motor installations. Refer to application note AP03402001E for NEC requirement for group motor installation.

**Individual Branch Motor Applications**

A UL 508 Type E self-protected manual combination starter/motor controller consists of a single device possessing four essential elements: disconnect, short circuit protection, motor controller, and motor overload protection. Some MMPs require use of a lineside adapter for this type of approval. When tested as an official combination by UL, this device takes the place of a fuse-starter or breaker-starter, **XT** Type E MMPs are self-protected, meaning they do not need additional short circuit protection of a fuse or breaker. Type E devices can also be used with a contactor or other types of UL approved controllers. If tested with a contactor, the combination motor controller becomes a Type F device. See **Page V5-T1-199** for XTFC Type F devices.

#### 1

### Features and Benefits

- ON/OFF rotary handle with lockout provision
- Visible trip indication
- Class 10 overload protection
- Phase loss sensitivity
- Ambient temperature compensation to IEC/EN 60947, VDE 0660
- Fixed short-circuit trip—14 times maximum setting of overload FLA dial
- Type 2 coordination per IEC 947
- Identification markers standard on starter faceplate
- Motor applications from 0.1A to 65A
- Built-in heater and magnetic trip elements to protect the motor
- Adjustment dial for setting motor FLA
- DIN rail mount
- Terminal types available:
  - Screw terminals
  - Screw (line) and spring cage (load) terminals
  - Spring cage terminals
- Accessories include:
  - Front and side auxiliary contacts
  - Trip indicating contacts
  - Tamperproof cover for OLR dial
  - Undervoltage release
  - Shunt trip
  - Through-the-door operators
  - Enclosures
  - Three-phase line side connecting links

### Standards and Certifications

- CE approved
- UL listed File No. E245398
- UL 508 group motor and Type E compliant
- IEC/EN 60947
- CSA File 229767, Class 3211-05
- DIN VDE 0660 Part 100, Part 101 and Part 102



**Note:** For Type 2 Coordination of MMCs, see **Page V5-T1-230**.

### Line Side Adapters—When to Use Them

**Note:** Line side adapters are not required for non-US applications. Most countries outside of the US classify the MMP as a thermal magnetic circuit breaker.

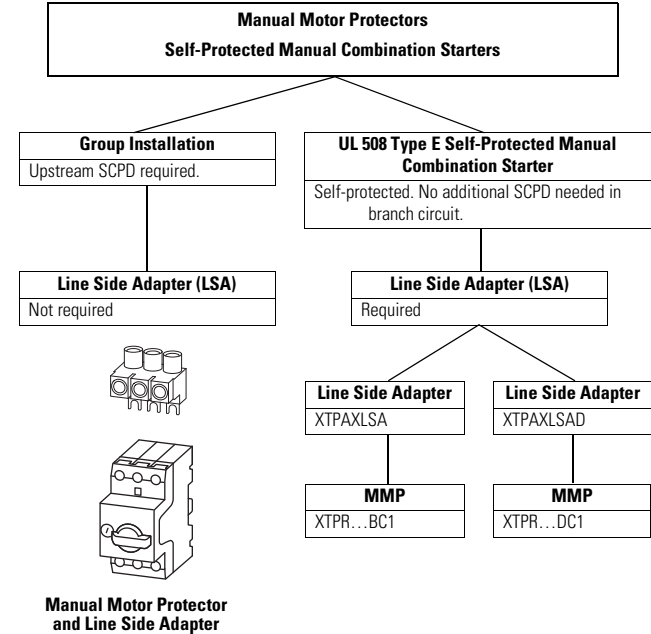

## Product Identification

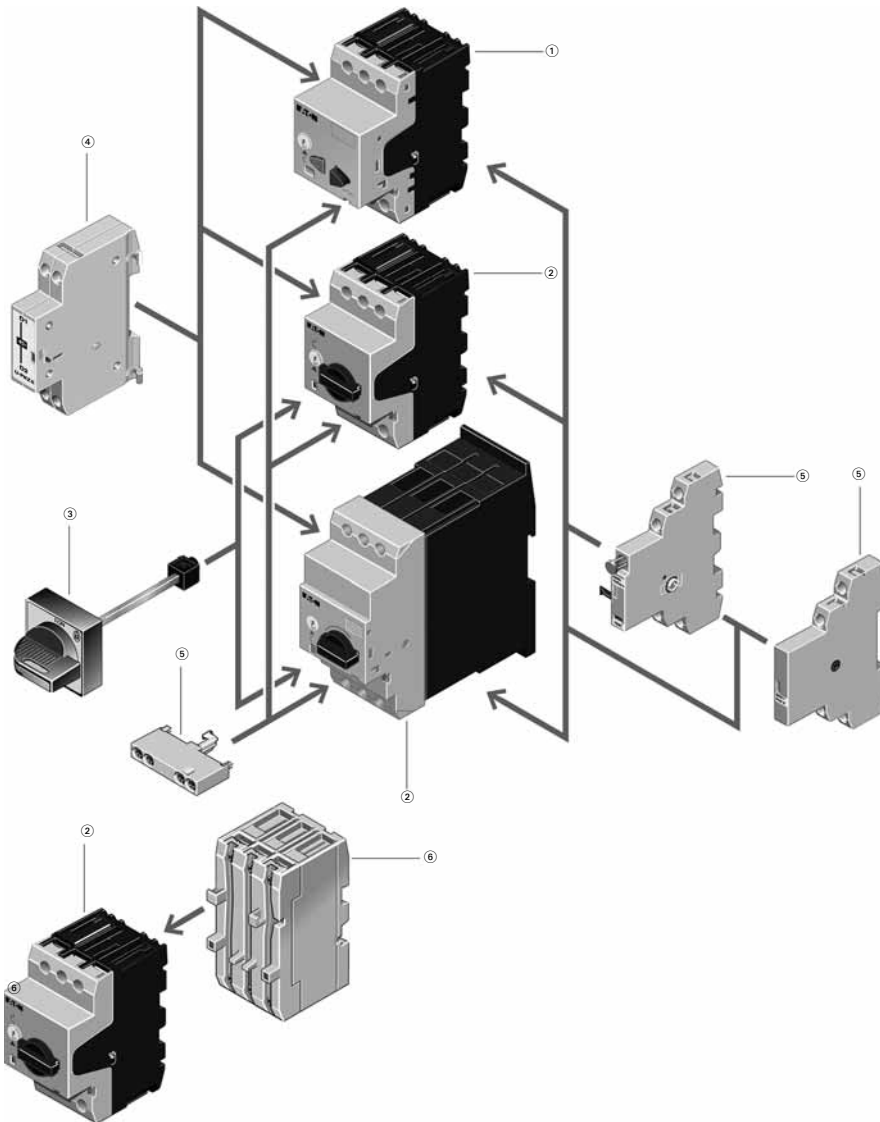

## Notes

## Basic Units

- ① XTPB pushbutton manual motor protectors (see [Page V5-T1-161](#))
  - Rated operational current up to 25A
  - Switching capacity 50 kA/415V
  - Short-circuit release, adjustable  $0.6-1 \times I_n$
  - Single-phasing sensitive
- ② XTPR rotary manual motor protectors (see [Page V5-T1-162](#))
  - Rated operational current up to 32A, 65A
  - Switching capacity 150/50 kA/415V
  - Short-circuit release, fixed setting to  $14 \times I_n$
  - Overload release, adjustable  $0.6-1 \times I_n$
  - Single-phasing sensitive
  - With screws or spring-loaded terminals

## Mounting Accessories

- ③ Rotary handle mechanism (see [Page V5-T1-167](#))
  - ON/OFF/tripped switch position indication
  - Lockable door/cover interlock
  - Extendable y plug fit extension shaft
  - Handle latched in switch positions
  - Optionally also without locking and door interlock function

Insulated enclosures (see [Page V5-T1-171](#))

Surface mounting, enclosures, IP40, IP55 and IP40 and IP55 front flush mounting enclosure

Mounting/wiring (see [Page V5-T1-167](#))

Component adapter for busbar mounting  
Three-phase commoning link for side-by-side-mounting  
Mounting kits for rapid mounting of direct-on-line, reversing and star-delta starters

## Add-On Functions

- ④ Voltage releases (see [Page V5-T1-166](#))
  - Undervoltage release
  - Shunt releases
  - With screws or spring-loaded terminals
- ⑤ Standard auxiliary contacts (see [Page V5-T1-164](#))
  - ON/OFF indication
  - Differential fault indication overload/short-circuit release
  - ON/OFF for (high capacity) contact module
  - ON/OFF for starter combination
  - With early-make contacts
  - With screws or spring-loaded terminals
- ⑥ Current limiter (see [Page V5-T1-166](#))
  - Increases the switching capacity of the 10–25A manual motor protectors to 100 kA/440V
  - Can be used for individual group protection

#### 1

### Catalog Number Selection

#### XT Manual Motor Protectors

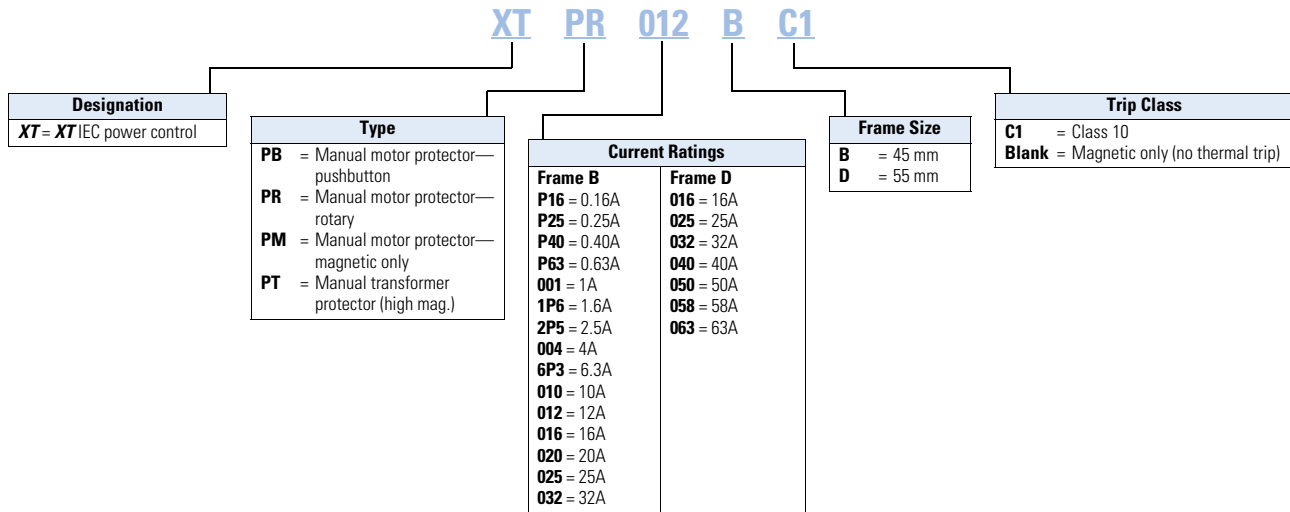



## Product Selection

### Product Selection for Manual Motor Starter Applications

When ordering, specify catalog numbers according to the following stipulations:

**XT** manual motor protectors are selected based on the overload current range required for a given motor. This current range is determined from the motor full load ampere rating and motor service factor usually found on the motor nameplate.

**For motors with service factors less than 1.15,** multiply the motor FLA by 0.90 to select appropriate MMP.

Example: For motor having FLA of 6.4A and service factor of 1.0 ( $6.4A \times 0.90 = 5.76A$ ) select catalog number XTPB6P3B01.

See Application Note—  
AP03402001E.

**For motor with service factor of 1.15 or greater,** use motor nameplate full load amperes to select the appropriate MMP.

Example: For motor having FLA of 11A and service factor of 1.15, select catalog number XTPR012BC1.

### Frame B



### XTPB Pushbutton Manual Motor Protectors—Global and North American Ratings—Frame B

Type 1 and Type 2 Coordination Motor Protective Device with Thermal and Magnetic Trip

Rated Uninterrupted Current— $I_u = I_o$ (Amps)	FLA Adjustment Range/Overload Release— $I_r$ (Amps)	Short Circuit Release— $I_m$ (Amps)	Maximum Motor Ratings ①					Maximum hp Rating—P (hp) UL 508/CSA C22.2 No. 14				Screw Terminal Catalog Number
			Maximum kW Rating AC-3—P (kW)			Three-Phase						
			220–240V	380–415V	440V	500V	660–690V	200V	240V	480V	600V	
0.16	0.1–0.16	2.2	—	—	—	—	0.06	②	②	②	②	XTPBP16BC1
0.25	0.16–0.25	3.5	—	0.06	0.06	0.06	0.12	②	②	②	②	XTPBP25BC1
0.4	0.25–0.4	5.6	0.06	0.09	0.12	0.12	0.18	②	②	②	②	XTPBP40BC1
0.63	0.4–0.63	8.8	0.09	0.12	0.18	0.25	0.25	②	②	②	②	XTPBP63BC1
1	0.63–1	14	0.12	0.25	0.25	0.37	0.55	②	②	2	1/2	XTPB001BC1
1.6	1–1.6	22	0.25	0.55	0.55	0.75	1.1	②	②	3/4	3/4	XTPB1P6BC1
2.5	1.6–2.5	35	0.37	0.75	1.1	1.1	1.5	1/2	1/2	1	1-1/2	XTPB2P5BC1
4	2.5–4	56	0.75	1.5	1.5	2.2	3	3/4	3/4	2	3	XTPB004BC1
6.3	4–6.3	88	1.1	2.2	3	3	4	1	1-1/2	3	5	XTPB6P3BC1
10	6.3–10	140	2.2	4	4	4	7.5	3	3	7-1/2	10	XTPB010BC1
12	8–12	168	3	5.5	5.5	5.5	11	3	3	7-1/2	10	XTPB012BC1
16	10–16	224	4	7.5	9	9	12.5	3	5	10	10	XTPB016BC1
20	16–20	280	5.5	9	11	12.5	15	5	—	—	15	XTPB020BC1
25	20–25	350	5.5	12.5	12.5	15	22	—	7-1/2	15	20	XTPB025BC1

#### Notes

Single-phasing sensitivity to IEC/EN 60947-4-1, VDE 0660 Part 102.

Can be snap-fit to IEC/EN 60715 top-hat (DIN) with 7.5 or 15 mm height.

Service Factor (SF)—Setting  $I_r$  of current scale in dependence of load factor:

$$SF = 1.15 \rightarrow I_r = 1 \times I_{n \text{ mot}}$$

$$SF = 1 \rightarrow I_r = 0.9 \times I_{n \text{ mot}}$$

For manual motor protective circuit breaker switching capacity, see **Page V5-T1-181**.

① Select manual motor protectors by full load amperes. Maximum motor ratings (kW, hp) are for reference only.

② In this range, calculate motor rating according to rated current. Specified values to NEC 430.6(A)(1).

1

Frame B



### XTPR Rotary Manual Motor Protectors with Screw Terminals— Global Ratings and North American Ratings—Frame B

Type 1 and Type 2 Coordination Motor Protective Device with Thermal and Magnetic Trip

Rated Uninterrupted Current— $I_u = I_e$ (Amps)	FLA Adjustment Range/ Overload Release— $I_r$ (Amps)	Short Circuit Release— $I_m$ (Amps)	Maximum Motor Ratings ①								Screw Terminal Catalog Number	
			Maximum kW Rating AC-3—P (kW)				Maximum hp Rating—P (hp) UL 508/CSA C22.2 No. 14					
			Three-Phase									
			220– 240V	380– 415V	440V	500V	660– 690V	200V	240V	480V	600V	
0.16	0.1–0.16	2.2	—	—	—	—	0.06	②	②	②	②	XTPRP16BC1
0.25	0.16–0.25	3.5	—	0.06	0.06	0.06	0.12	②	②	②	②	XTPRP25BC1
0.4	0.25–0.4	5.6	0.06	0.09	0.12	0.12	0.18	②	②	②	②	XTPRP40BC1
0.63	0.4–0.63	8.8	0.09	0.12	0.18	0.25	0.25	②	②	②	②	XTPRP63BC1
1	0.63–1	14	0.12	0.25	0.25	0.37	0.55	②	②	②	②	XTPR001BC1
1.6	1–1.6	22	0.25	0.55	0.55	0.75	1.1	②	②	3/4	3/4	XTPR1P6BC1
2.5	1.6–2.5	35	0.37	0.75	1.1	1.1	1.5	1/2	1/2	1	1-1/2	XTPR2P5BC1
4	2.5–4	56	0.75	1.5	1.5	2.2	3	3/4	3/4	2	3	XTPR004BC1
6.3	4–6.3	88	1.1	2.2	3	3	4	1	1-1/2	3	5	XTPR6P3BC1
10	6.3–10	140	2.2	4	4	4	7.5	3	3	7-1/2	10	XTPR010BC1
12	8–12	168	3	5.5	5.5	5.5	11	3	3	7-1/2	10	XTPR012BC1
16	10–16	224	4	7.5	9	9	12.5	3	5	10	10	XTPR016BC1
20	16–20	280	5.5	9	11	12.5	15	5	—	—	15	XTPR020BC1
25	20–25	350	5.5	12.5	12.5	15	22	—	7-1/2	15	20	XTPR025BC1
32	25–32	448	7.5	15	15	22	30	7-1/2	10	20	25	XTPR032BC1

Frame D



### XTPR Rotary Manual Motor Protectors with Screw Terminals— Global Ratings and North American Ratings—Frame D

Type 1 and Type 2 Coordination Motor Protective Device with Thermal and Magnetic Trip

Rated Uninterrupted Current— $I_u = I_e$ (Amps)	FLA Adjustment Range/ Overload Release— $I_r$ (Amps)	Short Circuit Release— $I_m$ (Amps)	Maximum Motor Ratings ①								Screw Terminal Catalog Number	
			Maximum kW Rating AC-3—P (kW)				Maximum hp Rating—P (hp) UL 508/CSA C22.2 No. 14					
			Three-Phase									
			220– 240V	380– 415V	440V	500V	660– 690V	200V	240V	480V	600V	
16	10–16	224	4	7.5	9	9	12.5	3	5	10	15	XTPR016DC1
25	16–25	350	5.5	12.5	12.5	15	22	7-1/2	7-1/2	15	20	XTPR025DC1
32	25–32	448	7.5	15	17.5	22	22	10	10	20	30	XTPR032DC1
40	32–40	560	11	20	22	24	30	10	15	30	30	XTPR040DC1
50	40–50	700	14	25	30	30	45	10	15	30	40	XTPR050DC1
58	50–58	812	17	30	37	37	55	15	15	40	50	XTPR058DC1
65	55–65	882	18.5	34	37	45	55	15	15	40	50	XTPR063DC1

**Notes**

Single-phasing sensitivity to IEC/EN 60947-4-1, VDE 0660 Part 102.

Can be snap-fit to IEC/EN 60715 top-hat (DIN) with 7.5 or 15 mm height.

Service Factor (SF)—Setting  $I_r$  of current scale in dependence of load factor:

$$SF = 1.15 \rightarrow I_r = 1 \times I_{n \text{ mot}}$$

$$SF = 1 \rightarrow I_r = 0.9 \times I_{n \text{ mot}}$$

For manual motor protective circuit breaker switching capacity, see **Page V5-T1-181**.

① Select manual motor protectors by full load amperes. Maximum motor ratings (kW, hp) are for reference only.

② In this range, calculate motor rating according to rated current. Specified values to NEC 430.6(A)(1).

Frame B



### XTPR Manual Self-Protected Motor Starters—North American Ratings, UL 508 Type E—Frame B<sup>①</sup>

Motor Protective Device with Thermal and Magnetic Trip

Rated Uninterrupted Current— $I_u$ (Amps)	FLA Adjustment Range/Overload Release— $I_r$ (Amps)	Short Circuit Release— $I_m$ (Amps)	Maximum Motor Ratings <sup>②</sup>				Rated Short-Circuit Breaking Capacity (kA)			Line Side Adapter <sup>①</sup> Catalog Number	Manual Motor Protector—Screw Terminal Catalog Number
			Maximum hp Rating—P (hp) Three-Phase				480/ 277V	600/ 247V	480/ 277V		
0.16	0.1–0.16	2.2	③	③	1/2	1/2	50	50	XTPAXLSA	XTPRP16BC1	
0.25	0.16–0.25	3.4	③	③	1/2	1/2	50	50	XTPAXLSA	XTPRP25BC1	
0.4	0.25–0.4	5.6	③	③	1/2	1/2	50	50	XTPAXLSA	XTPRP40BC1	
0.63	0.4–0.63	8.8	③	③	1/2	1/2	50	50	XTPAXLSA	XTPRP63BC1	
1	0.63–1	14	③	③	1/2	1/2	50	50	XTPAXLSA	XTPR001BC1	
1.6	1–1.6	22	③	③	3/4	3/4	50	50	XTPAXLSA	XTPR1P6BC1	
2.5	1.6–2.5	35	1/2	1/2	1	1-1/2	50	50	XTPAXLSA	XTPR2P5BC1	
4	2.5–4	56	3/4	1	2	3	50	50	XTPAXLSA	XTPR004BC1	
6.3	4–6.3	88	1	1-1/2	3	5	65	50	XTPAXLSA	XTPR6P3BC1	
10	6.3–11	140	3	3	7-1/2	10	65	50	XTPAXLSA	XTPR010BC1	
12	8–12	168	3	3	7-1/2	—	65	—	XTPAXLSA	XTPR012BC1	
16	10–16	224	3	5	10	—	42	—	XTPAXLSA	XTPR016BC1	
20	16–20	280	5	5	—	—	18	—	XTPAXLSA	XTPR020BC1	
25	20–25	350	5	7-1/2	15	—	18	—	XTPAXLSA	XTPR025BC1	
32	25–32	448	7-1/2	10	25	—	18	—	XTPAXLSA	XTPR032BC1	

Frame D



### XTPR Manual Self-Protected Motor Starters—North American Ratings, UL 508 Type E—Frame D<sup>①</sup>

Motor Protective Device with Thermal and Magnetic Trip

Rated Uninterrupted Current— $I_u$ (Amps)	FLA Adjustment Range/Overload Release— $I_r$ (Amps)	Short Circuit Release— $I_m$ (Amps)	Maximum Motor Ratings <sup>②</sup>				Rated Short-Circuit Breaking Capacity (kA)			Line Side Adapter <sup>①</sup> Catalog Number	Manual Motor Protector—Screw Terminal Catalog Number
			Maximum hp Rating—P (hp) Three-Phase				240V	480/ 277V	600/ 247V		
16	10–16	224	3	5	10	10	65	65	25	XTPAXLSAD	XTPR016DC1
25	16–25	350	7-1/2	7-1/2	20	25	65	65	25	XTPAXLSAD	XTPR025DC1
32	25–32	448	10	10	25	30	65	65	25	XTPAXLSAD	XTPR032DC1
40	32–40	560	10	—	30	30	65	65	25	XTPAXLSAD	XTPR040DC1
50	40–50	700	—	15	30	—	65	65	—	XTPAXLSAD	XTPR050DC1
58	50–58	812	—	—	40	—	65	65	—	XTPAXLSAD	XTPR058DC1
65	55–65	882	—	—	40	—	65	65	—	XTPAXLSAD	XTPR063DC1

#### Notes

A UL 508 Type E self-protected manual combination starter (XTPR) consists of a manual motor protector (XTPR) and a UL Listed line side adapter (for example, XTPAXLSA). The Type E self-protected manual combination starter alone is a legitimate short-circuit protective device and disconnect means for the downstream motor, while the contactor has been added to provide remote operation of the motor circuit. Conductor size for XTPAXLSA is 14–6 AWG, XTPAXLSAD is 8 AWG–1/0.

① UL 508 Type E starters are assembled from a standard XTPR and a special incoming terminal line side adapter (XTPAXLSA or XTPAXLSAD).

② Select manual motor protectors by full load amperes. Maximum motor ratings (kW, hp) are for reference only.

③ In this range, calculate motor rating according to rated current. Specified values to NEC 430.6(A)(1).

## Accessories

### Auxiliary Contacts

#### XTPAXSA\_



#### Side-Mount Auxiliary Contacts

Contact Configuration	Contact Sequence	Pkg. Qty. ①	Screw Terminal Catalog Number
1NO-1NC		5	XTPAXSA11
1NO-2NC		5	XTPAXSA12
2NO-1NC		5	XTPAXSA21

Can be fitted on the right side of manual motor protectors (XTPB, XTPR, XTPM) and manual transformer protectors (XTPT) and can be combined with XTPAXSATR\_ and XTPAXFA\_ trip indicating auxiliary contact.

#### XTPAXFA11



#### Front-Mount Auxiliary Contacts

Contact Configuration	Contact Sequence	Pkg. Qty. ①	Screw Terminal Catalog Number
1NO-1NC		5	XTPAXFA11

Can be fitted to manual motor protectors (XTPB, XTPR, XTPM) and manual transformer protectors (XTPT). 45 mm (XTPR...B and XTPB) or 55 mm (XTPR...D) widths of manual motor protectors remain unchanged.

**Note**

① Orders must be placed in multiples of package quantity listed.

## XTPAXSATR\_

## Side-Mount Trip Indicating Auxiliary Contacts



Contact Configuration	Contact Sequence	Pkg. Qty. ①	For Use with...	Catalog Number
2 x 1NO		2	XTPB, XTPR, XTPM, XTPT	<b>XTPAXSATR20</b>
2 x 1NC		2	XTPB, XTPR, XTPM, XTPT	<b>XTPAXSATR02</b>

Can be fitted on the right side of manual motor protectors. Can be combined with standard auxiliary contacts. Trip indication: A. General trip indication (overload) B. Short-circuit trip. Local short-circuit indication by red indicator, manually resettable.

## Early-Make Front-Mount Auxiliary Contacts

## XTPBXFAEM20



Contact Configuration	Contact Sequence	Pkg. Qty. ①	For Use with...	Catalog Number
2NO		5	XTPB	<b>XTPBXFAEM20</b>
XTPAXFAEM20		2	XTPR, XTPM, XTPT	<b>XTPAXFAEM20</b> ②

## XTPAXFAEM20

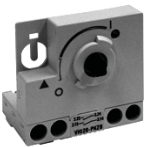

For use with XTPB\_, Frame B XTPR and XTPT. Can be fitted to the front of a manual motor protector. 45 mm width of manual motor protector remains unchanged. For early energization of undervoltage release, for example, in emergency-stop circuits to EN 60204.

**Notes**

- ① Orders must be placed in multiples of package quantity listed.
- ② Not for use with rotary handle mechanism.

### Additional Accessories

#### XTPAXSR\_



#### Contact Sequence

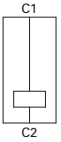

#### Shunt Release

Pkg. Qty. ①	Screw Terminal Catalog Number
2	XTPAXSR24V50H
2	XTPAXSR48V50H
2	XTPAXSR110V50H
2	XTPAXSR120V60H
2	XTPAXSR208V60H
2	XTPAXSR220V50H
2	XTPAXSR230V50H
2	XTPAXSR240V50H
2	XTPAXSR240V60H
2	XTPAXSR380V50H
2	XTPAXSR400V50H
2	XTPAXSR415V50H
2	XTPAXSR440V60H
2	XTPAXSR480V60H
2	XTPAXSR24VDC
2	XTPAXSR48VDC
2	XTPAXSR60VDC
2	XTPAXSR110VDC
2	XTPAXSR125VDC
2	XTPAXSR220VDC
2	XTPAXSR250VDC

Can be used to trip the manual motor protector from a remote location. Can be fitted on the left side of manual motor protectors. Cannot be combined with the XTPAXUVR. DC: Intermittent operation 5 sec.

#### XTPAXUVR\_



#### Contact Sequence

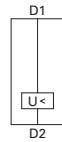

#### Undervoltage Release

Pkg. Qty. ①	Screw Terminal Catalog Number
2	XTPAXUVR24V50H
2	XTPAXUVR24V60H
2	XTPAXUVR48V50H
2	XTPAXUVR60V50H
2	XTPAXUVR110V50H
2	XTPAXUVR120V60H
2	XTPAXUVR208V60H
2	XTPAXUVR220V50H
2	XTPAXUVR230V50H
2	XTPAXUVR240V50H
2	XTPAXUVR240V60H
2	XTPAXUVR380V50H
2	XTPAXUVR400V50H
2	XTPAXUVR415V50H
2	XTPAXUVR440V60H
2	XTPAXUVR480V60H
2	XTPAXUVR600V60H

Can be used to trip the manual motor protector from a remote location. Can be fitted on left side manual motor protectors. Cannot be combined with XTPAXSR. When combined with a circuit breaker, it can be used as emergency-stop device to IEC/EN 60204.

#### XTPAXCL



#### Current Limiter ②



Description	Contact Sequence	Pkg. Qty. ①	Catalog Number
To enhance the switching capacity of non-inherently safe 10–25A manual motor protectors to 150 kA/440V		1	XTPAXCL

The XTPAXCL enhances the switching capacity of the XT manual motor protectors. It can be used with the XTPB, XTPR...BC1, XTPR...DC1 for individual or group protections. The rated uninterrupted current is 63A for IEC and 25A for UL/CSA. It can be mounted next to or behind the manual motor protector. See **Page V5-T1-181** for ratings when using the current limiter.

#### Notes

- ① Orders must be placed in multiples of package quantity listed.
- ② Max. rated operation voltage  $U_e = 690V$ , rated uninterrupted current  $I_n = 63A$ . Can be used for individual and group protection. For group protection and in combination with the XTPR...D order additional XTPAXIT incoming terminal if required. Mounting next to or behind the manual motor protector. 16–63A XTPR...D: 100 kA/400V, 10 kA/690V.

## IP65 Rotary Handle Mechanism ①②③④













	Description	Enclosure Rating	Pkg. Qty. ⑤	Catalog Number
<b>XTPAXRHM_</b> 	<b>Complete Kits—Includes Handle, Shaft and Required Hardware</b>			
	Rotary handle mechanism—black ⑥	IP65	1	<b>XTPAXRHMB</b>
	Rotary handle mechanism—red/yellow ⑦	NEMA 12 UL/CSA 4X	1	<b>XTPAXRHMRY</b>
	Rotary handle mechanism—black—rotated 90° from vertical ⑥		1	<b>XTPAXRHM90B</b>
	Rotary handle mechanism—red/yellow—rotated 90° from vertical ⑦		1	<b>XTPAXRHM90RY</b>
<b>XTPAXRHMSFT</b> 	<b>Separate Parts</b>			
	Shaft only—includes shaft to mount to XTPR, 175 mm length	—	10	<b>XTPAXRHMSFT</b>

**XTPAXSW**

## Sealing Facility

Description	Pkg. Qty. ⑤	Catalog Number
To prevent tampering with the overload release and the test function. It can be sealed using industry standard sealing wire. For use with XTPR manual motor protectors.	5	<b>XTPAXSW</b>

## Three-Phase Commoning Links ⑧

For Use with...	Qty. MMP	MMP Frame Size	Pkg. Qty. ⑤	Catalog Number
    	2	B	10	<b>XTPAXCLKA2</b>
		D	1	<b>XTPAXCLKA2D</b>
	3	B	10	<b>XTPAXCLKA3</b>
		D	1	<b>XTPAXCLKA3D</b>
	4	B	10	<b>XTPAXCLKA4</b>
D		1	<b>XTPAXCLKA4D</b>	
Each MMP with one auxiliary contact or trip-indicating auxiliary contact fitted on the right     	2	B	10	<b>XTPAXCLKB2</b>
		D	1	<b>XTPAXCLKB2D</b>
	3	B	10	<b>XTPAXCLKB3</b>
		D	1	<b>XTPAXCLKB3D</b>
	4	B	10	<b>XTPAXCLKB4</b>
D		1	<b>XTPAXCLKB4D</b>	
Each MMP with an auxiliary contact and trip-indicating auxiliary contact mounted on the right or a voltage release mounted on the left.  	2	B	10	<b>XTPAXCLKC2</b>
	4	D	1	<b>XTPAXCLKC4D</b>

For parallel power feed to several manual motor protectors on terminals 1, 3 and 5.

**Notes**

- ① Plug-in connection shafts, XTPAXRHMSFT\_ can be cut to desired length for mounting depths of 100–240 mm. Carrier with extension shaft included.
- ② With ON/OFF switch position and “+” (tripped), lockable with 3 padlocks, 4–8 mm hasp. Can be locked in the OFF position, if required.
- ③ Rotary handle mechanisms ship with door interlock disabled. See instruction publication with product for how to enable door interlock.
- ④ Not for use with XTPAXFAEM20 early-make front-mount auxiliary contact.
- ⑤ Orders must be placed in multiples of package quantity listed.
- ⑥ For use on main switches to IEC/EN 60204.
- ⑦ For use on main switches with emergency-stop function to IEC/EN 60204.
- ⑧ Protected against accidental contact. Frame B short-circuit proof  $U_0 = 690V$ ,  $I_0 = 63A$ . Frame B links can be combined by rotating mounting.

#### XTPAXUTS



#### Shroud for Unused Terminals of Three-Phase Commoning Links

For Use with...	Description	Pkg. Qty. ①	Catalog Number
Frame B XTPR	To cover unused terminals on three-phase commoning link. Protected against direct contact.	20	<b>XTPAXUTS</b>

#### XTPAXIT



#### Incoming Terminals for Three-Phase Commoning Link ②

For Use with...	Pkg. Qty. ①	Catalog Number
Frame B XTPR, XTPB	5	<b>XTPAXIT</b>

#### Line-Side Adapter ③

For Use with...	Pkg. Qty. ①	Catalog Number
-----------------	-------------	----------------

#### XTPAXLSA



Frame B XTPR to create a UL 508 Type E/F manual combination starter	5	<b>XTPAXLSA</b>
---	---	-----------------

#### XTPAXLSAD



Frame D XTPR to create a UL 508 Type E/F manual combination starter	1	<b>XTPAXLSAD</b> ④
---	---	--------------------

### Combination Connection Kits

#### Non-Reversing Starters

	For Use with...	Description/Comprised of ...	Std. Pack ①	Catalog Number
<b>XTPAXTPCB</b> 	XTPR...B + XTCE...B	Mechanical connection element for XTPR...B and contactor	1	<b>XTPAXTPCB</b>
		Main current wiring between XTPR...B and contactor in toolless plug connection	1	
		Use contactor auxiliary switch XTCEXFAT_. Control cable guidance: max. six cables up to 2.5 mm <sup>2</sup> external diameter or four cables up to 3.5 mm <sup>2</sup> external diameter.		
<b>XTPAXTPC_</b> 	XTPR...B + XTCE...C	DIN rail adapter plate Main current wiring between XTPR and contactor	1	<b>XTPAXTPCC</b>
	XTPR...D + XTCE...D	DIN rail adapter plate Main current wiring between XTPR and contactor	1	<b>XTPAXTPCD</b>

#### Notes

- ① Orders must be placed in multiples of package quantity listed.
- ② For three-phase commoning link, protected against accidental contact,  $U_b = 690V$ ,  $I_u = 63A$ ;  
For conductor cross-sections: 2.5–25 mm<sup>2</sup> stranded; 2.5–16 mm<sup>2</sup> flexible with ferrules, AWG 14-6.
- ③ XTPAXLSA is for three-phase commoning link, finger and back-of-hand proof,  
 $U_b = 690V$ ,  $I_u = 60A$  for conductor cross sections: 2.5–25 mm<sup>2</sup> stranded,  
2.5–16 mm<sup>2</sup> flexible with ferrule, AWG 14-6.
- ④ XTPAXLSAD cannot be combined with three-phase commoning links. Conductor size 8 AWG–1/0.

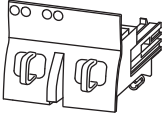
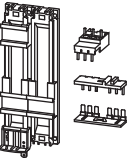

## Reversing Starters

	For Use with...	Description/Comprised of ...	Std. Pack <sup>①</sup>	Catalog Number
<b>XTPAXTPCRB</b> 	XTPR...B + XTCE...B01_	Mechanical connection element for XTPR...B and contactor	1	<b>XTPAXTPCRB</b>
		Reversing starter main current wiring in toolless plug connection	1	
		Control cables for electrical interlocking in toolless plug connection: – K1M: A1–K2M: Z1 – K1M: 21–K2M: A1 – K1M: A2–K2M: A2	1	
		Cable guidance	1	
		Use contactor auxiliary switch XTCEXFAT_ Control cable guidance: max. six cables up to 2.5 mm <sup>2</sup> external diameter or four cables up to 3.5 mm <sup>2</sup> external diameter.		
<b>XTPAXTPCRC</b> 	XTPR...B + XTCE...C	DIN rail adapter plate	1	<b>XTPAXTPCRC</b>
		Reversing starter main current wiring	1	

**Note**

<sup>①</sup> Orders must be placed in multiples of package quantity listed.

1

#### XTPAXECM\_

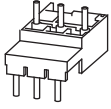

#### Electrical Connection Module

For Use with...	Description/Comprised of ...	Std. Pack <sup>①</sup>	Catalog Number
XTPR...B + XTCE...C	Main current wiring between XTPR...B and contactor	5	<b>XTPAXECMC</b>
XTPR...D + XTCE...D	Main current wiring between XTPR...D and contactor	5	<b>XTPAXECMD</b>

#### DIN Rail Adapter Plates

#### XTPAXTPCPB

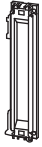

For Use with...	Description/Comprised of ...	Std. Pack <sup>①</sup>	Catalog Number
XTPAXTPCB	45 mm wide adapter plate with one DIN rail	4	<b>XTPAXTPCPB</b>
XTPAXTPCRB	Connection element for side-by-side positioning of further plates		

#### XTPAXTPCPD







XTPAXECMD	55 mm wide adapter plate with two DIN rails	4	<b>XTPAXTPCPD</b>
XTPR...D + XTCE...C	Connection cams for further plates		
XTPR...D + XTCE...D	For use with reversing and star-delta starters		

#### Note



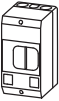

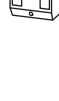

<sup>①</sup> Orders must be placed in multiples of package quantity listed.

## Pushbutton MMP Enclosures

Insulated Enclosures for Surface Mounting of XTPB Pushbutton Motor-Protective Circuit Breakers—Global Usage <sup>①</sup>

	Degree of Protection	For Use with...	Description	Catalog Number
	IP40 NEMA 1	XTPB MMP only or with: XTPAXFA_, XTPBXFAEM20, XTPAXSA_, XTPAXUVR_, XTPAXSR_	—	<b>XTPBXENCS40</b>
	IP65 NEMA 3R, 4X, 12, 13		With actuation membrane.	<b>XTPBXENCS65</b>
	IP65 NEMA 3R, 4X, 12, 13	XTPB MMP only or with: XTPAXFA_, XTPAXUVR_, XTPAXSR_, XTPAXCL	Lockable in OFF position.	<b>XTPBXENCSL065</b>
	IP65 NEMA 3R, 4X, 12, 13	XTPB MMP only or with: XTPAXFA_, XTPBXFAEM20, XTPAXUVR_, XTPAXSR_, XTPAXCL	Lockable in OFF position in combination with XTPBXFAEM20 early-make front-mount auxiliary contact	<b>XTPBXENCSLE65</b>
	IP65 NEMA 3R, 4X, 12, 13		With emergency-stop (e-stop) pushbutton actuator, red-yellow	<b>XTPBXENCSES65</b>
	IP65 NEMA 3R, 4X, 12, 13		With emergency-stop (e-stop) pushbutton actuator, red-yellow key release	<b>XTPBXENCSEK65</b>

Insulated Enclosures for Surface Mounting of XTPB Pushbutton Manual Motor Protectors—North American Usage <sup>②③</sup>

	Degree of Protection	For Use with...	Description	Catalog Number
	IP41 NEMA 1	XTPB MMP only or with: XTPAXFA_, XTPBXFAEM20, XTPAXSA_, XTPAXUVR_, XTPAXSR_	—	<b>XTPBXENAS41</b>
	IP65 NEMA 3R, 4X, 12, 13		With actuating diaphragm	<b>XTPBXENAS65</b>
	IP65 NEMA 3R, 4X, 12, 13	XTPB MMP only or with: XTPAXFA_, XTPAXUVR_, XTPAXSR_, XTPAXCL	Lockable in OFF position	<b>XTPBXENASL065</b>
	IP65 NEMA 3R, 4X, 12, 13	XTPB MMP only or with: XTPAXFA_, XTPBXFAEM20, XTPAXUVR_, XTPAXSR_, XTPAXCL	Lockable in OFF position in combination with XTPBXFAEM20 early-make front-mount auxiliary contact	<b>XTPBXENASLE65</b>
	IP65 NEMA 3R, 4X, 12, 13		With emergency-stop (e-stop) pushbutton actuator, red-yellow	<b>XTPBXENASES65</b>
	IP65 NEMA 3R, 4X, 12, 13		With emergency-stop (e-stop) pushbutton actuator, red-yellow key release	<b>XTPBXENASEK65</b>





**Notes**

① Integrated terminal for PE(N) connection, two M25 cable entry knockouts at top and at bottom.

② Built-in terminal for PE(N).

③ North American enclosures come with conduit adapters for use with 1/2 in NPT.

#### Insulated Enclosures for Surface Mounting of XTPB Pushbutton Manual Motor Protectors—North American Usage <sup>①</sup>







	Degree of Protection	For Use with...	Description	Catalog Number
	Front IP40 NEMA 1	XTPB MMP only or with: XTPAXFA_, XTPBXFAEM20, XTPAXSA_, XTPAXUVR_, XTPAXSR_	—	<b>XTPBXENCF40</b>
	Front IP65 NEMA 3R, 4X, 12, 13		With actuating diaphragm	<b>XTPBXENCF55</b>
	Front IP65 NEMA 3R, 4X, 12, 13	XTPB MMP only or with: XTPAXFA_, XTPAXUVR_, XTPAXSR_, XTPAXCL	Lockable in OFF position	<b>XTPBXENCFLO55</b>
	Front IP65 NEMA 3R, 4X, 12, 13	XTPB MMP only or with: XTPAXFA_, XTPBXFAEM20, XTPAXUVR_, XTPAXSR_, XTPAXCL	Lockable in OFF position in combination with XTPBXFAEM20 early-make front-mount auxiliary contact	<b>XTPBXENCFLE55</b>
	Front IP65 NEMA 3R, 4X, 12, 13		With emergency-stop (e-stop) pushbutton actuator, red-yellow	<b>XTPBXENCFES55</b>
	Front IP65 NEMA 3R, 4X, 12, 13		With emergency-stop (e-stop) pushbutton actuator, red-yellow key release	<b>XTPBXENCFEK55</b>

**Note**

① Integrated terminal for PE(N) connection.

## Rotary MMP Enclosures





Insulated Enclosures for Surface Mounting of Frame B (0.1–32A)  
XTPR Motor-Protective Circuit Breakers—Global Usage

	Degree of Protection	For Use with...	Description	Catalog Number
	IP41 with vertical mounting	Frame B XTPR only or with: XTPAXFA_, XTPAXSA_, XTPAXSATR_, XTPAXUVR_, XTPAXSR_, XTPAXCL	Cover with aperture dimensioned to accommodate front of MMP. IP40, when mounted turned through 90° to left/right	XTPAXENC541 <sup>①</sup>
	IP65		With black/grey rotary handle	XTPAXENC565B <sup>①</sup>
	IP65		With red/yellow rotary handle for use as emergency-stop switches to IEC/EN 60204	XTPAXENC565RY <sup>①</sup>
	IP40	Frame B XTPR only or with: XTPAXSA_, XTPAXUVR_, XTPAXSR_, XTPAXCL	Cover with aperture dimensioned to accommodate front of MMP	XTPAXENC540 <sup>②</sup>
	IP55	Frame B XTPR only or with: XTPAXFA_, XTPAXSA_, XTPAXUVR_, XTPAXSR_, XTPAXCL	With black/gray rotary handle	XTPAXENC555B <sup>②</sup>
	IP55		With red/yellow rotary handle for use as emergency-stop switches to IEC/EN 60204	XTPAXENC555RY <sup>②</sup>

Insulated Enclosures for Surface Mounting of Frame B (0.1–32A)  
XTPR Rotary Manual Motor Protectors—North American Usage <sup>③</sup>

	Degree of Protection	For Use with...	Description	Catalog Number
	IP55 NEMA 1, 12, 3R	Frame B XTPR only or with: XTPAXSA_ and XTPAXFA_, XTPAXUVR_ and XTPAXFA_, XTPAXSR_ and XTPAXFA_, XTPAXCL	With black/gray rotary handle	XTPAXENAS55B
			With red/yellow rotary handle for use as emergency-stop switch to VDE 0113	XTPAXENAS55RY

## Insulated Enclosures for Surface Mounting of Frame B XTPR (0.1–32A) Rotary Motor-Protective Circuit Breakers with XTPAXFAEM20 Early-Make Front-Mount Auxiliary Contact—Global Usage

	Degree of Protection	For Use with...	Description	Catalog Number
	IP65	Frame B XTPR and XTPAXFAEM20 only or with: XTPAXFA_, XTPAXSA_, XTPAXSATR_, XTPAXUVR_, XTPAXSR_, XTPAXCL	With black/gray rotary handle	XTPAXENCSEM65B
	IP65		With red/yellow rotary handle for use as emergency-stop switches to IEC/EN 60204	XTPAXENCSEM65RY
	IP55	Frame B XTPR and XTPAXFAEM20 only or with: XTPAXFA_, XTPAXUVR_, XTPAXSR_, XTPAXCL	With black/gray rotary handle	XTPAXENCSEM55B
	IP55		With red/yellow rotary handle for use as emergency-stop switches to IEC/EN 60204	XTPAXENCSEM55RY

## Notes

- ① M25 metric cable entry knock-out, top and bottom. Cable push-through membrane, top and bottom, in the back plate and as a control line entry. Includes N and PE terminals.
- ② Integrated terminal for PE(N) connection, two M25 cable entry knockouts at the top and bottom.
- ③ Built-in N and PE terminal, lower part without knockouts.

1



#### Insulated Enclosures for Surface Mounting of Frame B XTPR (0.1–32A) Rotary Manual Motor Protectors with XTPAXFAEM20 Early-Make Front-Mount Auxiliary Contact—North American Usage <sup>①</sup>

Degree of Protection	For Use with...	Description	Catalog Number
IP55 NEMA 1, 12, 3R	Frame B XTPR only or with: XTPAXSA_, XTPAXUVR_, XTPAXCL	With black/grey rotary handle	<b>XTPAXENASEM55B</b>
		With red/yellow rotary handle for use as emergency-stop switch to VDE 0113	<b>XTPAXENASEM55RY</b>

#### Insulated Enclosures for Flush Mounting of Frame B (0.1–32A) XTPR Rotary Manual Motor Protectors—Global Usage <sup>②</sup>



Degree of Protection	For Use with...	Description	Catalog Number
Front IP40	Frame B XTPR only or with: XTPAXSA_, XTPAXUVR_, XTPAXSR_, XTPAXCL	Cover with aperture dimensioned to accommodate front of MMP	<b>XTPAXENCF40</b>
Front IP55	Frame B XTPR only or with: XTPAXSA_, XTPAXUVR_, XTPAXSR_, XTPAXFA_, XTPAXCL	With black/grey rotary handle	<b>XTPAXENCF55B</b>
		With red/yellow rotary handle for use as emergency-stop switches to IEC/EN 60204	<b>XTPAXENCF55RY</b>



#### Insulated Enclosures for Surface Mounting of Frame D (10–65A) Rotary Motor-Protective Circuit Breakers



Degree of Protection	For Use with...	Description	Catalog Number
IP65 NEMA 1, 12, 3R, 4X	Frame D XTPR only or with: XTPAXFA_, XTPAXFAEM20, XTPAXSA_, XTPAXSATR_, XTPAXUVR_, XTPAXSR_, XTPAXCL	With black/grey rotary handle	<b>XTPAXENCSD65B</b>
		With red/yellow rotary handle for use as emergency-stop switches to IEC/EN 60204	<b>XTPAXENCSD65RY</b>

#### Notes

- ① Built-in N and PE terminal, lower part without knockouts.
- ② Integrated terminal for PE(N) connection.

**MMP Enclosure Accessories****XTPAXPL\_****XTPR Manual Motor Protector Enclosure Padlock Attachment**

For Use with...	Description	Pkg. Qty. <sup>①</sup>	Catalog Number
XTPAXENC565B, XTPAXENC565RY, XTPAXENCSEM65B, XTPAXENCSEM65RY, XTPAXENC555B, XTPAXENC555RY, XTPAXENCSEM55B, XTPAXENCSEM55RY	Padlocking feature. Up to three padlocks with 3–6 mm hasp thickness. For use as main switch to IEC/EN 60204	3	<b>XTPAXPL1</b> <sup>②</sup>
XTPAXENCSD65B, XTPAXENCSD65RY		1	<b>XTPAXPL2</b> <sup>②</sup>
XTPAXENC555B, XTPAXENC555RY		3	<b>XTPAXPL3</b> <sup>③</sup>

**XTPAXNT****Neutral Terminal for Use with XTPB and Frame B XTPR Flush-Mount Enclosures**

For Use with...	Description	Pkg. Qty. <sup>①</sup>	Catalog Number
XTPBXENCF40, XTPBXENCF55, XTPAXENCF40, XTPAXENCF55B, XTPAXENCF55RY	For connection of a fifth conductor	20	<b>XTPAXNT</b>

**XTPAXIL\_****Indicating Lights with Neon Bulb <sup>④</sup>**

Color	Description— Indicating Light	Pkg. Qty. <sup>①</sup>	Catalog Number
White	110–230V	10	<b>XTPAXILWB</b>
	230–400V	10	<b>XTPAXILWN</b>
	415–500V	10	<b>XTPAXILWC</b>
Green	110–230V	10	<b>XTPAXILGB</b>
	230–400V	10	<b>XTPAXILGN</b>
	415–500V	10	<b>XTPAXILGC</b>
Red	110–230V	10	<b>XTPAXILRB</b>
	230–400V	10	<b>XTPAXILRN</b>

For use with XTPR and XTPB enclosures.

Lights do not carry individual IP or NEMA rating. All enclosure ratings remain valid when using indicating lights.

**Notes**

- ① Orders must be placed in multiples of package quantity listed.
- ② Lockable in the 0-position of the XTPR manual motor protector.
- ③ Lockable in the OFF position of the Frame B XTPR manual motor protector.
- ④ Product is not UL Listed/Registered.

## Technical Data and Specifications

### XT Manual Motor Protectors

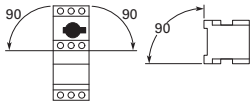
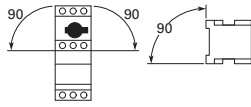
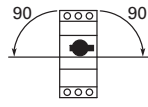
Description	XTPBP16B– XTPB025B	XTPRP16B– XTPR032B	XTPR016D– XTPR063D
<b>General</b>			
Standards	IEC/EN 60947, VDE 0660, UL 508, CSA C22.2 No. 14	IEC/EN 60947, VDE 0660, UL 508, CSA C22.2 No. 14	IEC/EN 60947, VDE 0660, UL 508, CSA C22.2 No. 14
Climatic proofing	①	①	①
Ambient temperature, °C			
Storage	–25/80	–25/80	–25/70
Open	–25/55	–25/55	–25/55
Enclosed	–25/40	–25/40	–25/40
Mounting position			
Direction of incoming supply	As required	As required	As required
Degree of protection			
Device	IP20	IP20	IP20
Terminals	IP00	IP00	IP00
Protection against direct contact	Finger and back-of-hand proof	Finger and back-of-hand proof	Finger and back-of-hand proof
Shock resistance half-sinusoidal shock 10 ms to IEC 60068-2-27 (g)	25	25	15
Altitude (m), maximum	2000	2000	2000
Terminal capacity			
Solid (mm <sup>2</sup> )	1 x (1–6) 2 x (1–6)	1 x (1–6) 2 x (1–6)	1 x (1–50) 2 x (1–35)
Flexible with ferrule to DIN 46228, (mm <sup>2</sup> )	1 x (1–6) 2 x (1–6)	1 x (1–6) 2 x (1–6)	1 x (1–35) 2 x (1–35)
Solid or stranded (AWG)	18–10	18–10	14–2
Terminal screw tightening torque			
Main cable, Nm	1.7	1.	3
Main cable, lb-in	15.0	15.0	26.6
Control circuit cable, Nm	1	1	1
Control circuit cable, lb-in	8.9	8.9	8.9
<b>Main Contacts</b>			
Rated impulse withstand voltage ( $U_{imp}$ ), Vac	6000	6000	6000
Overvoltage category/pollution degree	III/3	III/3	III/3
Rated operational voltage ( $U_e$ ), Vac	690	690	690
Rated uninterrupted current = rated operational current ( $I_u = I_e$ ) in amperes	25 or current setting of the overcurrent release	25 or current setting of the overcurrent release	25 or current setting of the overcurrent release
Rated frequency, Hz	40–60	40–60	40–60
Current heat loss (three-pole at operating temperature), W	6	6	22
Lifespan, mechanical (ops)	50,000	100,000	30,000
Lifespan, electrical (AC-3 at 400V) (ops)	50,000	100,000	30,000
Maximum operating frequency, operations/hr	25	40	40
Short-circuit rating			
AC	See <a href="#">Page V5-T1-181</a>	See <a href="#">Page V5-T1-181</a>	See <a href="#">Page V5-T1-181</a>
DC (kA)	60	60 (up to XTPR016B) 40 (XTPR020B–XTPR032B)	60
Motor switching capacity			
AC-3 (up to 690V) in amperes	25	32	65
DC-5 (up to 250V) in amperes	25	25 (3 contacts in series)	63 (3 contacts in series)

#### Note

① Damp heat, constant, to IEC 60068-2-78; damp heat, cyclic, to IEC 60068-2-30.



## XT Manual Motor Protectors, continued

Description	XTPBP16B– XTPB025B	XTPRP16B– XTPR032B	XTPR016D– XTPR063D
<b>Releases</b>			
Overload release setting range ( $\times I_N$ )	0.6–1.0	0.6–1.0	0.6–1.0
Fixed short-circuit release ( $\times I_N$ )	14	14	14
Short-circuit release tolerance	$\pm 20\%$	$\pm 20\%$	$\pm 20\%$
Phase-failure sensitivity	IEC/EN 60947-1-1, VDE 0660 Part 102	IEC/EN 60947-1-1, VDE 0660 Part 102	IEC/EN 60947-1-1, VDE 0660 Part 102
Temperature compensation to IEC/EN 60947, VDE 0660, °C	–5/40	–5/40	–5/40
operating range, °C	–25/55	–25/55	–25/55
Temperature compensation residual error for $T > 20^\circ\text{C}$ , %/K	$\leq 0.25$	$\leq 0.25$	$\leq 0.25$

## Auxiliary Contacts

Description	XTPAXSA_ _	XTPAXFA_ _	XTPA(B)XFAEM_ _	XTPAXSATR_ _
Rated impulse withstand voltage, $U_{imp}$ (Vac)	6000	4000	4000	6000
Overtoltage category/pollution degree	III/3	III/3	III/3	III/3
Rated operational voltage				
$U_e$ (Vac)	500	440	440	500
$U_e$ (Vdc)	250	250	250	250
Safe isolation to VDE 0106 Part 101 and Part 101/A1 between auxiliary contacts and main contacts (Vac)	690	690	690	690
Rated operational current				
AC-15				
220–240 V, $I_e$ (A)	3.5	1	1	3.5
380–415 V, $I_e$ (A)	2	—	—	2
440–500 V, $I_e$ (A)	1	—	—	1
DC-13 L/R <100 ms				
24 V, $I_e$ (A)	2	2	2	2
60 V, $I_e$ (A)	1.5	—	—	1.5
110 V, $I_e$ (A)	1	—	—	1
220 V, $I_e$ (A)	0.25	—	—	0.25
<b>Lifespan</b>				
Mechanical, operations ( $\times 10^6$ )	0.1	0.1	0.1	0.01
Electrical, operations ( $\times 10^6$ )	0.05	0.1	0.1	0.005
Contact reliability (at $U_e = 24$ Vdc, $U_{min} = 17$ V, $I_{min} = 5.4$ mA, fault probability)	$<10^{-8}$ <1 fault at $1 \times 10^8$ operations	$<10^{-8}$ <1 fault at $1 \times 10^8$ operations	$<10^{-8}$ <1 fault at $1 \times 10^8$ operations	$<10^{-8}$ <1 fault at $1 \times 10^8$ operations
Positively driven contacts to ZH 1/457	Yes	—	—	—
<b>Short-Circuit Rating without Welding</b>				
Fuseless	FAZ-B4/1-HI	—	—	FAZ-B4/1-HI
Fuse (A gG/gL)	10	10	10	10
<b>Terminal Capacity</b>				
Solid or flexible conductor with ferrule (mm <sup>2</sup> )	0.75–2.5	0.75–1.5	0.75–1.5	0.75–2.5
Solid or stranded (AWG)	18–14	18–16	18–16	18–14

### Undervoltage Release

Description	XTPAXUVR_
<b>Cross-Section</b>	
Solid or flexible conductor with ferrule (mm <sup>2</sup> )	1 x (0.75–2.5) 2 x (0.75–2.5)
Solid or stranded (AWG)	1 x (18–14) 2 x (18–14)
<b>Main Contact</b>	
Rated operational voltage, U <sub>θ</sub> (Vac)	42–480
Rated operational voltage, U <sub>θ</sub> (Vdc)	24–250
Pickup voltage, x U <sub>s</sub>	0.85–1.1
Dropout voltage, x U <sub>s</sub>	0.7–0.35
<b>Power Consumption</b>	
Pickup AC (VA)	5
Sealing AC (VA)	3

### Current Limiter

Description	XTPAXCL
Rated impulse withstand voltage (U <sub>imp</sub> ), Vac	6000
Overvoltage category/pollution degree	III/3
Rated operational voltage, U <sub>θ</sub> (Vac)	690
Rated interrupted current = Rated operational current (I <sub>u</sub> = I <sub>θ</sub> ) in amperes	63

### XTPB, XTPR Single- and Two-Pole Circuits with DC and AC Current

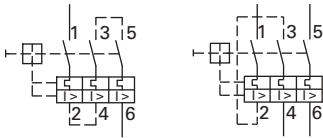

### Protection of PVC Insulated Cables Against Thermal Overload at Short-Circuit

Min. Cross-Section Protected					Device Type
4	2.5	1.5	1	0.75	
					XTPRP16BC1
					⋮
					XTPR6P3BC1
					XTPR010BC1
					XTPR016BC1
					XTPR020BC1
					XTPR025BC1
					XTPR016DC1
					XTPR025DC1
					XTPR032DC1
					XTPR040DC1
					XTPR050DC1
XTPR058DC1					
XTPR063DC1					

The chart above indicates which minimum cable cross-sections are protected by XTPR motor protective circuit breakers up to their rated conditional short-circuit current I<sub>q</sub>.

### Shunt Release

Description	XTPAXSR_
<b>Cross-Section</b>	
Solid or flexible conductor with ferrule (mm <sup>2</sup> )	1 x (0.75–2.5) 2 x (0.75–2.5)
Solid or stranded (AWG)	1 x (18–14) 2 x (18–14)
<b>Main Contact</b>	
Rated operational voltage, U <sub>θ</sub> (Vac)	42–480
Rated operational voltage, U <sub>θ</sub> (Vdc)	24–250
AC operating range, x U <sub>s</sub>	0.7–1.1
DC operating range, x U <sub>s</sub> (intermittent operation 5s)	0.7–1.1
<b>Power Consumption</b>	
Pickup AC (VA)	5
Sealing AC (VA)	3
Pickup DC (VA)	3
Sealing DC (VA)	3

**Wiring Diagrams**

**Fuseless Installation with XTPR**

**Backup Protection Diagram—XTPR...B**

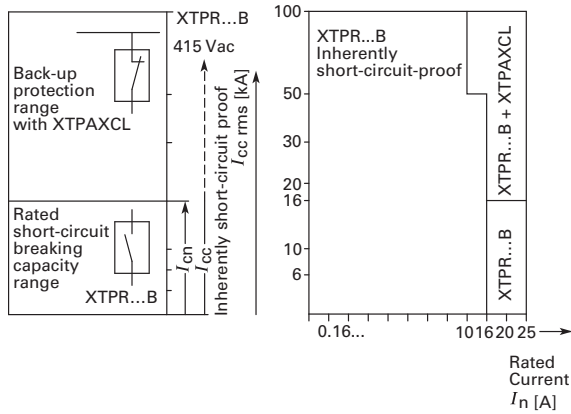

**Backup Protection Diagram—XTPR...D**

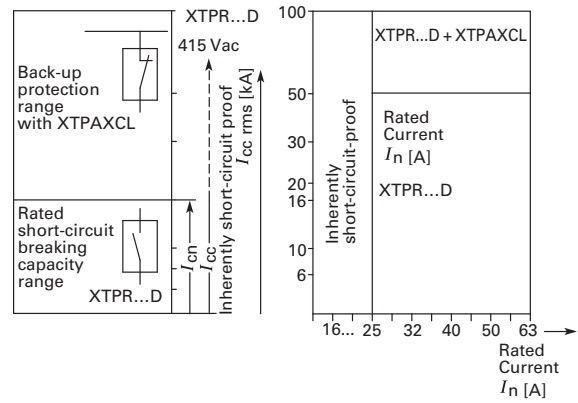

**Time/Current Curves**

**Characteristics**

The time/current characteristic, the current limiting characteristics and the  $I^2t$  characteristics were determined in accordance with DIN VDE 0660 and IEC 60 947.

The tripping characteristic of the **inverse-time delayed overload releases** (thermal overload releases or “a” releases) for DC and AC with a frequency of 0 to 400 Hz also apply to the time/current characteristic.

The characteristics apply to the cold state. At operating temperature, the tripping times of the thermal releases are reduced to approximately 25%.

Under normal operating conditions, all three-poles of the device must be loaded. The three main conducting paths must be connected in series in order to protect single-phase or DC loads.

With three-pole loading, the maximum deviation in the tripping time for 3 times the setting current and upwards is  $\pm 20\%$  and thus in accordance with DIN VDE 0165.

The tripping characteristics for the instantaneous, electromagnetic overcurrent releases (short-circuit releases or “n” releases) are based on the rated current  $I_n$ , which is also the maximum value of the setting range for circuit breakers with adjustable overload releases. If the current is set to a lower value, the tripping current of the “n” release is increased by a corresponding factor.

The characteristics of the electromagnetic overcurrent releases apply to frequencies of 50/60 Hz. Appropriate correction factors must be used for lower frequencies up to 16-2/3 Hz, for higher frequencies up to 400 Hz and for DC.

Time/current characteristics, current limiting characteristics and  $I^2t$  characteristics are available on request.

**MMP Tripping Characteristics**

**XTPB, XTPR Frame B**

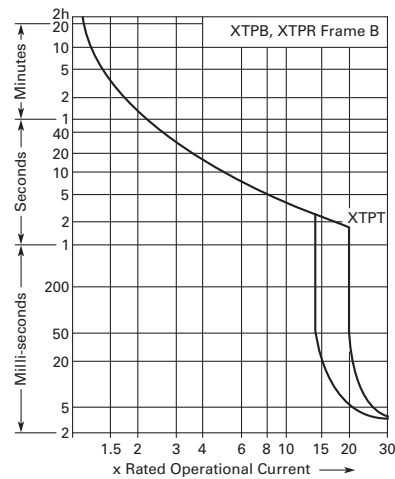

**XTPR Frame D**

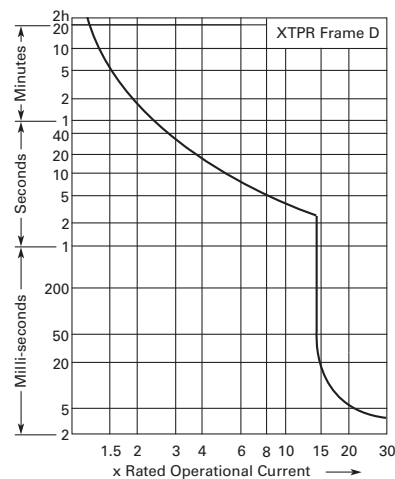

1

#### MMP Let-Through Tripping Characteristics

##### XTPB, XTPR Frame B

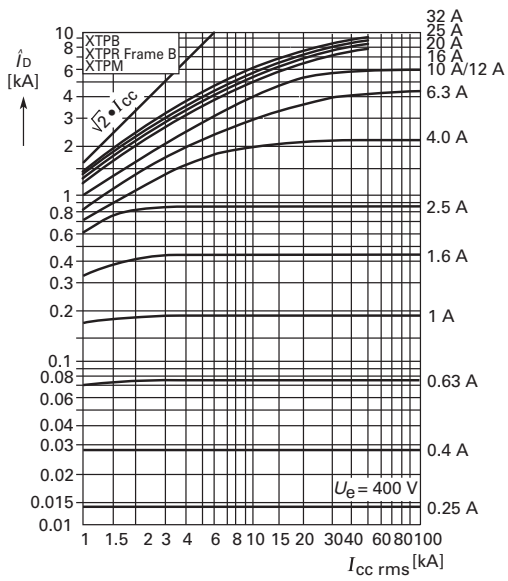

##### XTPR Frame D

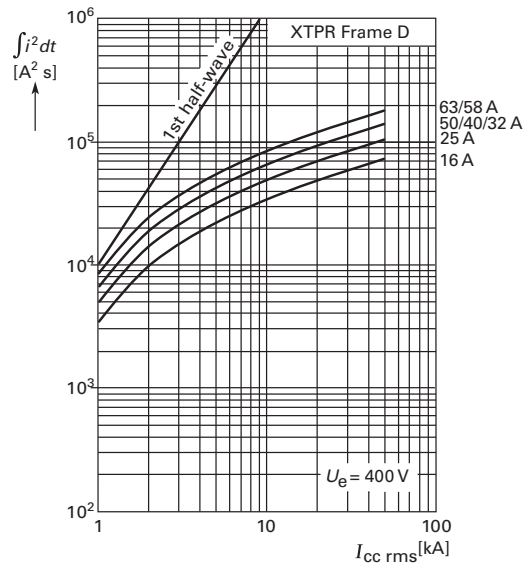

##### XTPR Frame D

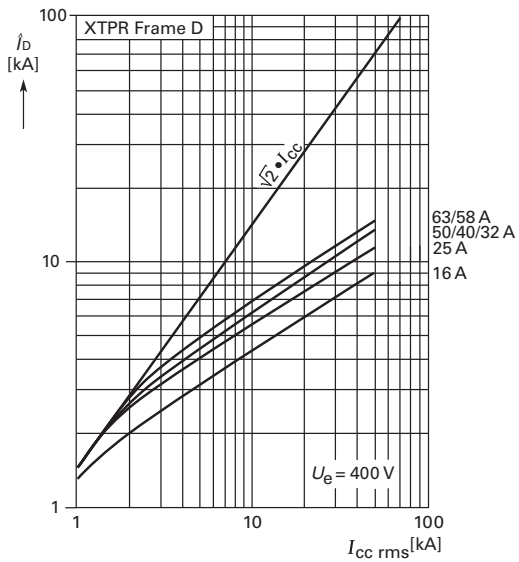

**Manual Motor Protector Short-Circuit Ratings**

Rated uninterrupted current  $I_u$  = Rated operational current  $I_e$ .

Rated conditional short-circuit current  $I_q$ —IEC/EN 60947-4-1.

Rated ultimate short-circuit breaking capacity  $I_{cu}$ —IEC/EN 60947-2.

Rated operational short-circuit breaking capacity  $I_{cs}$ —IEC/EN 60947-2.

**Global Use, IEC/EN 60947—XTPB with Classification Type “1” and Type “2”**

$I_u$ A	230V				400V				440V				500V				690V			
	$I_q$ kA	$I_{cu}$ kA	$I_{cs}$ kA	Fuse <sup>①②</sup> A	$I_q$ kA	$I_{cu}$ kA	$I_{cs}$ kA	Fuse <sup>①②</sup> A	$I_q$ kA	$I_{cu}$ kA	$I_{cs}$ kA	Fuse <sup>①②</sup> A	$I_q$ kA	$I_{cu}$ kA	$I_{cs}$ kA	Fuse <sup>①②</sup> A	$I_q$ kA	$I_{cu}$ kA	$I_{cs}$ kA	Fuse <sup>①②</sup> A
0.16–1	50	50	50	50	50	50	50	50	50	50	50	50	—	—	—	—	—	—	—	—
1.6	50	50	50	50	50	50	50	50	50	50	50	50	—	—	—	—	—	—	—	—
2.5	50	50	50	50	50	50	50	50	50	50	50	50	—	—	—	—	—	—	—	—
4	50	50	50	50	50	50	50	50	50	50	50	50	—	—	—	—	—	—	—	—
6.3	50	50	50	50	50	50	50	50	50	50	50	50	—	—	—	—	—	—	—	—
10	50	50	50	50	50	50	50	50	42	42	10	50	—	—	—	—	—	—	—	—
12	50	50	10	50	50	50	10	50	15	15	10	50	—	—	—	—	—	—	—	—
16	50	50	10	50	50	50	10	50	15	15	10	50	—	—	—	—	—	—	—	—
20	50	50	10	50	50	50	10	50	10	10	10	50	—	—	—	—	—	—	—	—
25	50	50	10	50	50	50	10	50	10	10	10	50	—	—	—	—	—	—	—	—

**Global Use, IEC/EN 60947—XTPR...BC1 with Classification Type “1” and Type “2”**

$I_u$ A	230V				400V				440V				500V				690V			
	$I_q$ kA	$I_{cu}$ kA	$I_{cs}$ kA	Fuse <sup>①②</sup> A	$I_q$ kA	$I_{cu}$ kA	$I_{cs}$ kA	Fuse <sup>①②</sup> A	$I_q$ kA	$I_{cu}$ kA	$I_{cs}$ kA	Fuse <sup>①②</sup> A	$I_q$ kA	$I_{cu}$ kA	$I_{cs}$ kA	Fuse <sup>①②</sup> A	$I_q$ kA	$I_{cu}$ kA	$I_{cs}$ kA	Fuse <sup>①②</sup> A
0.16–1	150 <sup>③</sup>	150 <sup>③</sup>	150 <sup>③</sup>	N	150 <sup>③</sup>	150 <sup>③</sup>	150 <sup>③</sup>	N	③	③	③	N	③	③	③	N	③	③	③	N
1.6	150 <sup>③</sup>	150 <sup>③</sup>	150 <sup>③</sup>	N	150 <sup>③</sup>	150 <sup>③</sup>	150 <sup>③</sup>	N	③	③	③	N	③	③	③	N	③	③	③	N
2.5	150 <sup>③</sup>	150 <sup>③</sup>	150 <sup>③</sup>	N	150 <sup>③</sup>	150 <sup>③</sup>	150 <sup>③</sup>	N	③	③	③	N	③	③	③	N	5	5	5	50
4	150 <sup>③</sup>	150 <sup>③</sup>	150 <sup>③</sup>	N	150 <sup>③</sup>	150 <sup>③</sup>	150 <sup>③</sup>	N	③	③	③	N	③	③	③	N	3	3	3	50
6.3	150 <sup>③</sup>	150 <sup>③</sup>	150 <sup>③</sup>	N	150 <sup>③</sup>	150 <sup>③</sup>	150 <sup>③</sup>	N	③	③	③	N	42	42	6	50	3	3	2	50
10	150 <sup>③</sup>	150 <sup>③</sup>	150 <sup>③</sup>	N	150 <sup>③</sup>	150 <sup>③</sup>	150 <sup>③</sup>	N	42	42	10	50	42	42	6	50	3	3	2	50
12	50	50	10	50	50	50	10	50	15	15	10	50	15	15	6	50	3	3	2	50
16	50	50	10	50	50	50	10	50	15	15	10	50	15	15	6	50	3	3	2	50
20	50	50	10	50	50	50	10	50	15	15	10	50	6	6	6	50	3	3	2	50
25	50	50	10	50	50	50	10	50	10	10	10	50	6	6	6	50	3	3	2	50
32	50	50	10	50	50	50	10	50	10	10	10	50	6	6	6	50	3	3	2	50

**Notes**

① N = Not required.

② XTPR...BC1, XTPT, XTPM—Required back-up fuse if the short-circuit current exceeds the rated conditional short-circuit current ( $I_{cc} > I_q$ ); XTPB, XTPR...DC1—Fuse (A gG/gL) for enhancing the switching capacity of the motor protective circuit breaker to 100 kA.

③ No upstream protective device required, as it is the auto-protected range (100/150 kA—Frame B, 150 kA—Frame D).

#### Global Use, IEC/EN 60947—XTPR...DC1 with Classification Type “1” and Type “2”

I <sub>u</sub> A	230V				400V				440V				500V				690V			
	I <sub>q</sub> kA	I <sub>cu</sub> kA	I <sub>cs</sub> kA	Fuse <sup>①②</sup> A	I <sub>q</sub> kA	I <sub>cu</sub> kA	I <sub>cs</sub> kA	Fuse <sup>①②</sup> A	I <sub>q</sub> kA	I <sub>cu</sub> kA	I <sub>cs</sub> kA	Fuse <sup>①②</sup> A	I <sub>q</sub> kA	I <sub>cu</sub> kA	I <sub>cs</sub> kA	Fuse <sup>①②</sup> A	I <sub>q</sub> kA	I <sub>cu</sub> kA	I <sub>cs</sub> kA	Fuse <sup>①②</sup> A
16	150 <sup>③</sup>	150 <sup>③</sup>	25	N	150 <sup>③</sup>	150 <sup>③</sup>	25	N	45	45	25	100	15	15	100	8	8	2.5	100	
25	150 <sup>③</sup>	150 <sup>③</sup>	25	N	150 <sup>③</sup>	150 <sup>③</sup>	25	N	45	45	25	100	15	15	100	8	8	2.5	100	
32	50	50	25	100	50	50	25	100	45	45	25	100	15	15	100	5	5	2.5	100	
40	50	50	25	100	50	50	25	100	45	45	25	100	15	15	100	5	5	2.5	100	
50	50	50	25	100	50	50	25	100	45	45	25	100	15	15	100	5	5	2.5	100	
58	50	50	25	160	50	50	25	160	45	45	25	160	15	15	160	5	5	2.5	160	
63	50	50	25	160	50	50	25	160	45	45	25	160	15	15	160	5	5	2.5	160	

#### Ratings for Group Motor Applications

#### UL 508/CSA C22.2 No. 14—XTPB—Frame B, Manual Motor Protector with Thermal and Magnetic Trip

Catalog Number	Rated Uninterrupted Current— I <sub>u</sub> (Amps)	FLA Adjustment Range/Overload Release— I <sub>r</sub> (Amps)	Short Circuit Release— I <sub>m</sub> (Amps)	Maximum Protective Device for UL/CSA Group Protection					
				Maximum rms Sym Current— 480V (kA)	w/Current Limiter— XTPAXCL	Maximum Fuse Rating (A)	w/Current Limiter— XTPAXCL	Circuit Breaker Maximum (A)	w/Current Limiter— XTPAXCL
XTPBP16BC1	0.16	0.1–0.16	2.2	50	—	600	—	600	—
XTPBP25BC1	0.25	0.16–0.25	3.5	50	—	600	—	600	—
XTPBP40BC1	0.4	0.25–0.4	5.6	50	—	600	—	600	—
XTPBP63BC1	0.63	0.4–0.63	8.8	50	—	600	—	600	—
XTPB001BC1	1	0.63–1	14	50	—	600	—	600	—
XTPB1P6BC1	1.6	1–1.6	22	50	—	600	—	600	—
XTPB2P5BC1	2.5	1.6–2.5	35	50	—	600	—	600	—
XTPB004BC1	4	2.5–4	56	50	—	600	—	600	—
XTPB6P3BC1	6.3	4–6.3	88	50	—	600	—	600	—
XTPB010BC1	10	6.3–10	140	30	50	600	600	600	600
XTPB012BC1	12	8–12	168	10	50	150	600	125 <sup>⑤</sup>	600
XTPB016BC1	16	10–16	224	10	50	150	600	125 <sup>⑤</sup>	600
XTPB020BC1 <sup>④</sup>	20	16–20	280	10	18	150	600	125	600
XTPB025BC1 <sup>④</sup>	25	20–25	350	10	18	150	600	125	600

#### Notes

- ① N = Not required.
- ② XTPR...BC1, XTPT, XTPM—Required back-up fuse if the short-circuit current exceeds the rated, XTP conditional short-circuit current (I<sub>cc</sub> > I<sub>q</sub>); XTPB, XTPR...DC1—Fuse (A gG/gL) for enhancing the switching capacity of the motor protective circuit breaker to 100 kA.
- ③ No upstream protective device required, as it is the auto-protected range (100/150 kA—Frame B, 150 kA—Frame D).
- ④ IEC/EN 60947-4-1.
- ⑤ 22 kA 600 Vac.

**UL 508/CSA C22.2 No. 14—XTPR—Frame B (all Screw and Spring Cage Terminal Options), Manual Motor Protector with Thermal and Magnetic Trip**

Catalog Number	Rated Uninterrupted Current— $I_u$ (Amps)	FLA Adjustment Range/Overload Release— $I_r$ (Amps)	Short Circuit Release— $I_m$ (Amps)	Maximum Protective Device for UL/CSA Group Protection					
				Maximum rms Sym Current— 480V (kA)	w/Current Limiter— XTPAXCL	Maximum Fuse Rating (A)	w/Current Limiter— XTPAXCL	Circuit Breaker Maximum (A)	w/Current Limiter— XTPAXCL
XTPRP16BC1	0.16	0.1–0.16	2.2	50	—	600	—	600	—
XTPRP25BC1	0.25	0.16–0.25	3.5	50	—	600	—	600	—
XTPRP40BC1	0.4	0.25–0.4	5.6	50	—	600	—	600	—
XTPRP63BC1	0.63	0.4–0.63	8.8	50	—	600	—	600	—
XTPR01BC1	1	0.63–1	14	50	—	600	—	600	—
XTPR1P6BC1	1.6	1–1.6	22	50	—	600	—	600	—
XTPR2P5BC1	2.5	1.6–2.5	35	50	—	600	—	600	—
XTPR004BC1	4	2.5–4	56	50	—	600	—	600	—
XTPR6P3BC1	6.3	4–6.3	88	50	—	600	—	600	—
XTPR010BC1	10	6.3–10	140	30	50	600	600	600	600
XTPR012BC1	12	8–12	168	10	50	150	600	125	600
XTPR016BC1	16	10–16	224	10	50	150	600	125 <sup>①</sup>	600
XTPR032BC1	32	25–32	448	10	18	150	600	125	600
XTPR025BC1	25	20–25	350	10	18	150	600	125	600
XTPR032BC1	32	25–32	448	10	18	150	600	125	600

**UL 508/CSA C22.2 No. 14—XTPR—Frame D, Manual Motor Protector with Thermal and Magnetic Trip**

Catalog Number	Rated Uninterrupted Current— $I_u$ (Amps)	FLA Adjustment Range/Overload Release— $I_r$ (Amps)	Short Circuit Release— $I_m$ (Amps)	Maximum Protective Device for UL/CSA Group Protection					
				Maximum rms Sym Current— 480V (kA)	w/Current Limiter— XTPAXCL	Maximum Fuse Rating (A)	w/Current Limiter— XTPAXCL	Circuit Breaker Maximum (A)	w/Current Limiter— XTPAXCL
XTPR016DC1	16	10–16	224	65	—	600	—	600	—
XTPR025DC1	25	16–25	350	65	—	600	—	600	—
XTPR032DC1	32	25–32	448	65	—	600	—	600	—
XTPR040DC1	40	32–40	560	65	—	600	—	600	—
XTPR050DC1	50	40–50	700	65	—	600	—	600	—
XTPR058DC1	58	50–58	812	65	—	600	—	600	—
XTPR063DC1	65	55–63	882	65	—	600	—	600	—

**Note**

① 22 kA 600 Vac.

## 1 UL 508 Type E Ratings—XTPR Frame B + XTPAXLSA

Manual Motor Protector—Screw Terminal Catalog Number	Line Side Adapter Catalog Number	FLA Adjustment Range/Overload Release— $I_r$ (Amps)	Short Circuit Release— $I_m$ (Amps)	UL 508 Type E Application Maximum rms Symmetrical Short-Circuit Ratings (kA)		Maximum Upstream Protective Device (A) <sup>①</sup>	
				480/277V	600/347V	Maximum Fuse 600V	Maximum Circuit Breaker 600V
XTPRP16BB1	XTPAXLSA	0.1–0.16	2.2	50	50	Not required	Not required
XTPRP25BC1	XTPAXLSA	0.16–0.25	3.5	50	50	Not required	Not required
XTPRP40BC1	XTPAXLSA	0.25–0.4	5.6	50	50	Not required	Not required
XTPRP63BC1	XTPAXLSA	0.4–0.63	8.82	50	50	Not required	Not required
XTPR01BC1	XTPAXLSA	0.63–1	14	50	50	Not required	Not required
XTPR1P6BC1	XTPAXLSA	1–1.6	22.4	50	50	Not required	Not required
XTPR2P5BC1	XTPAXLSA	1.6–2.5	35	50	50	Not required	Not required
XTPR004BC1	XTPAXLSA	2.5–4	56	50	50	Not required	Not required
XTPR6P3BC1	XTPAXLSA	4–6.3	88.2	65	50	Not required	Not required
XTPR010BC1	XTPAXLSA	6.3–10	140	65	50	Not required	Not required
XTPR012BC1	XTPAXLSA	8–12	168	65	—	Not required	Not required
XTPR016BC1	XTPAXLSA	10–16	224	42	—	Not required	Not required
XTPR020BC1	XTPAXLSA	16–20	280	18	—	Not required	Not required
XTPR025BC1	XTPAXLSA	20–25	350	18	—	Not required	Not required
XTPR032BC1	XTPAXLSA	25–32	448	18	—	Not required	Not required

## UL 508 Type E Ratings—XTPR Frame D + XTPAXLSAD

Manual Motor Protector—Screw Terminal Catalog Number	Line Side Adapter Catalog Number	FLA Adjustment Range/Overload Release— $I_r$ (Amps)	Short Circuit Release— $I_m$ (Amps)	UL 508 Type E Application Maximum rms Symmetrical Short-Circuit Ratings (kA)			Maximum Upstream Protective Device (A) <sup>①</sup>	
				240V	480/277V	600/347V	Maximum Fuse 600V	Maximum Circuit Breaker 600V
XTPR016DC1	XTPAXLSAD	10–16	224	65	65	25	Not required	Not required
XTPR025DC1	XTPAXLSAD	16–25	350	65	65	25	Not required	Not required
XTPR032DC1	XTPAXLSAD	25–32	448	65	65	25	Not required	Not required
XTPR040DC1	XTPAXLSAD	32–40	560	65	65	25	Not required	Not required
XTPR050DC1	XTPAXLSAD	40–50	700	65	65	—	Not required	Not required
XTPR058DC1	XTPAXLSAD	50–58	812	65	65	—	Not required	Not required
XTPR063DC1	XTPAXLSAD	55–65	882	65	65	—	Not required	Not required

**Note**

<sup>①</sup> For UL 508 Type E applications, the manual motor protector assembly does not require a dedicated upstream protective device in the panel, thus a maximum rating is not required.



**Dimensions**

Approximate Dimensions in mm [in]

**Manual Motor Protectors—XTPB**

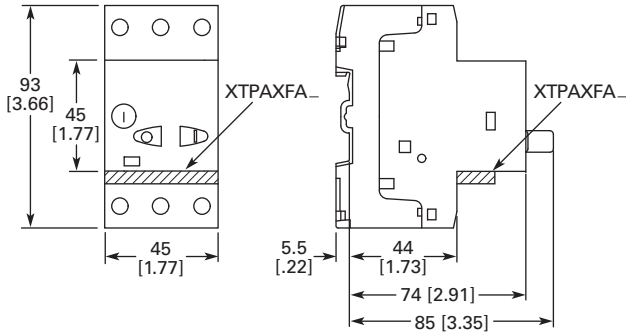

**Manual Motor Protectors, Manual Transformer Protectors—XTPR...B**

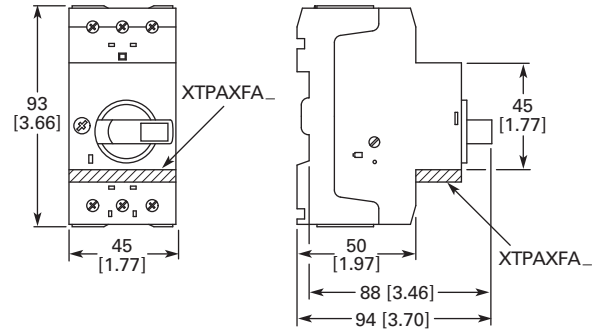

**Manual Motor Protector—XTPR...DC1**

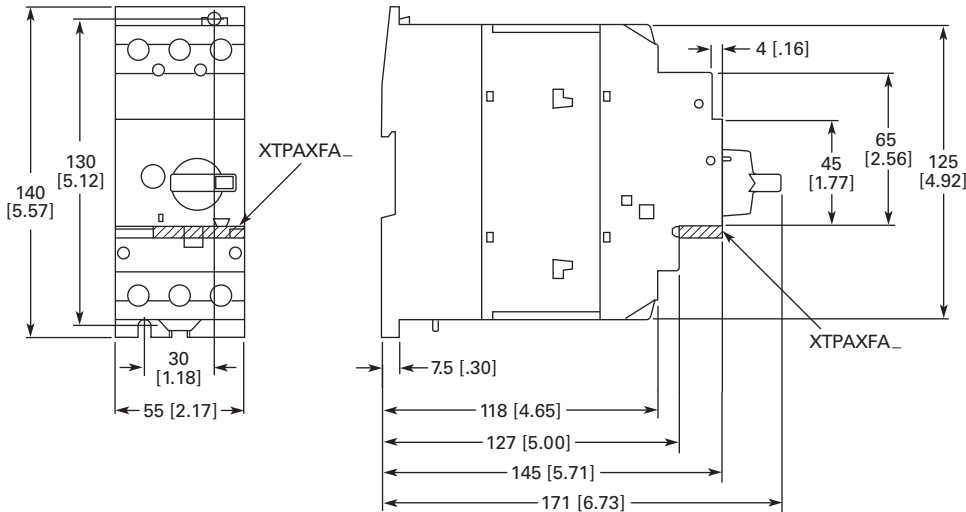

**Current Limiter—XTPAXCL**

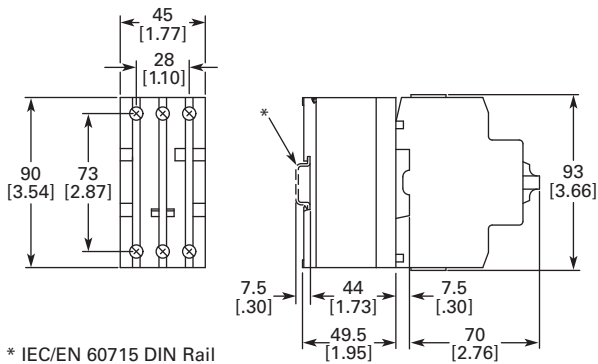

**MMPs with Early-Make Auxiliary Contacts—XTPR...BC1 + XTPAXFAEM20**

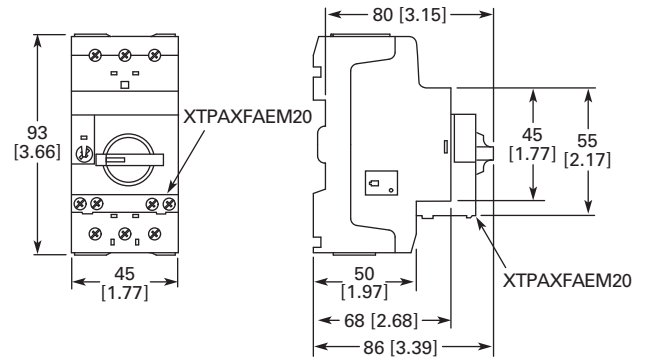

1

Approximate Dimensions in mm [in]

#### Standard Auxiliary Contact—XTPAXSA\_

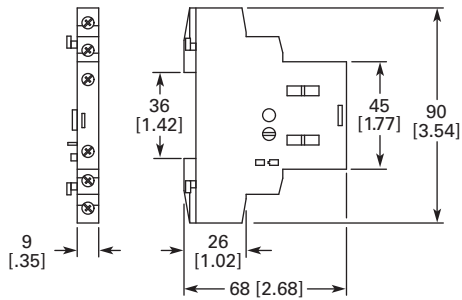

#### Trip Indicating Auxiliary Contact—XTPAXSATR\_

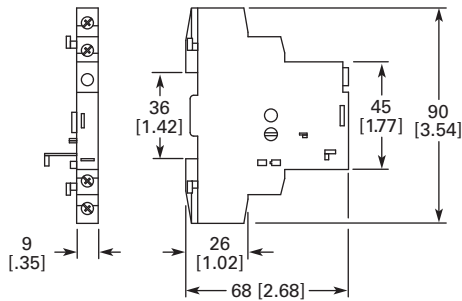

#### Undervoltage/Shunt Release—XTPAXUVR\_ , XTPAXSR\_

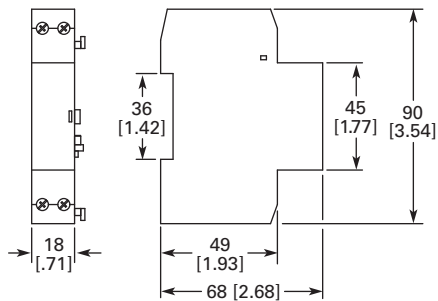

#### Three-Phase Commoning Link—XTPAXCLKA4, XTPAXCLKA2

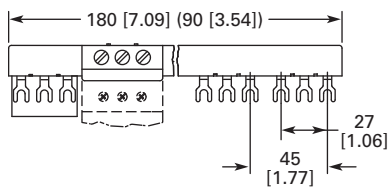

#### Three-Phase Commoning Link—XTPAXCLKB5, XTPAXCLKB4, XTPAXCLKB3 and XTPAXCLKB2

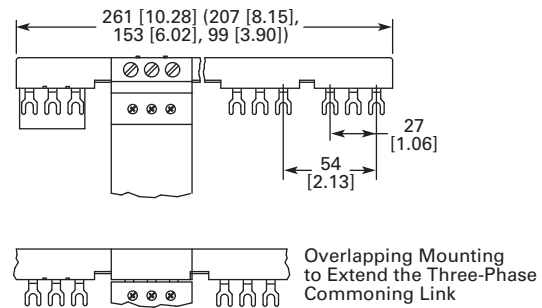

#### Three-Phase Commoning Link—XTPAXCLKC4, XTPAXCLKC2

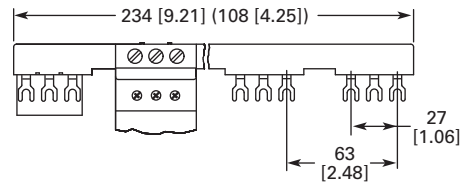

#### Incoming Terminal, Line Side Adapter—XTPAXIT, XTPAXLSA

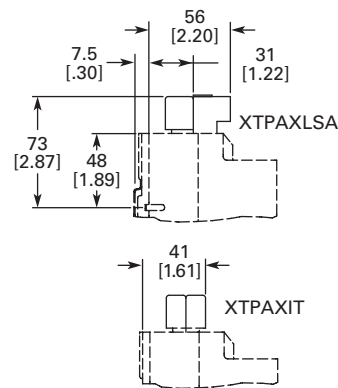

Approximate Dimensions in mm [in]

**Three-Phase Commoning Link**

**XTPAXCLKA4D, XTPAXCLKA3D and XTPAXCLKA2D**

**XTPAXCLKA4D**

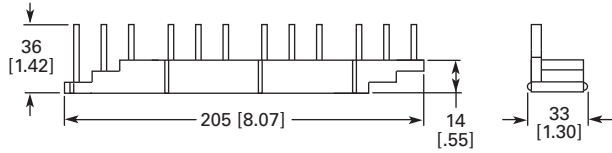

**XTPAXCLKC4D and XTPAXCLKC2D**

**XTPAXCLKC4D**

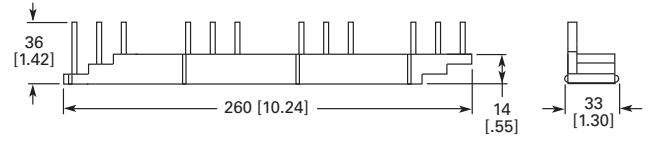

**XTPAXCLKA3D**

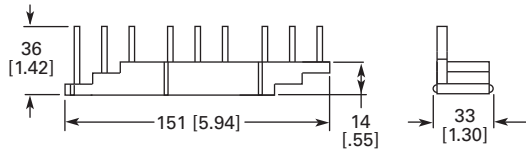

**XTPAXCLKC2D**

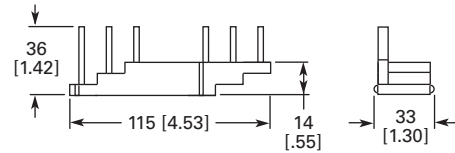

**XTPAXCLKA2D**

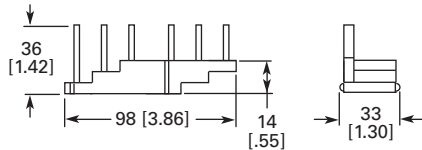

**XTPAXCLKB4D, XTPAXCLKB3D and XTPAXCLKB2D**

**XTPAXCLKB4D**

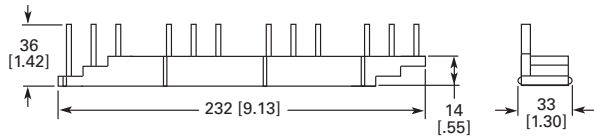

**XTPAXCLKB3D**

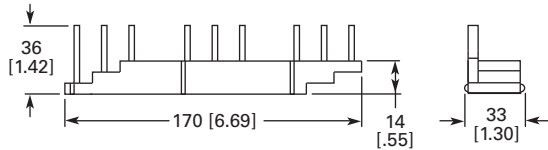

**XTPAXCLKB2D**

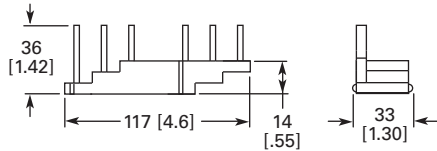

# 1.1

## IEC Contactors and Starters

### XT IEC Power Control

1

Approximate Dimensions in mm [in]

#### Insulated Enclosures for Surface Mounting of XTPB Manual Motor Protectors

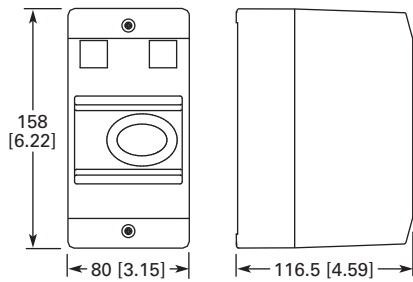

XTPBXENCS40, XTPBXENCS65, XTPBXENAS41, XTPBXENAS65

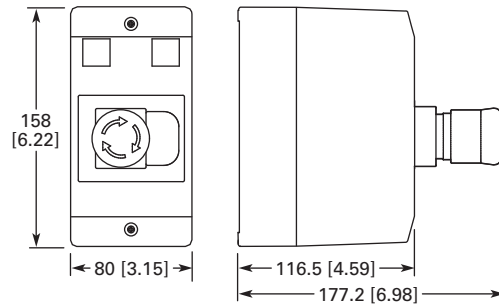

XTPBXENCSEK65, XTPBXENCSES65, XTPBXENASEK65, XTPBXENASES65

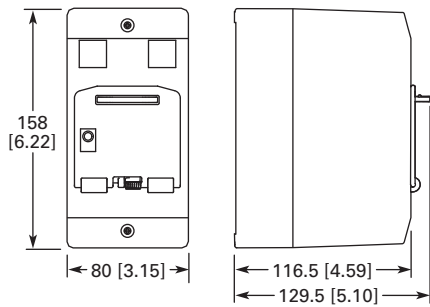

XTPBXENCSL65, XTPBXENCSL065, XTPBXENASL65, XTPBXENAS0065

#### Insulated Enclosures for Flush Mounting of XTPB Manual Motor Protectors

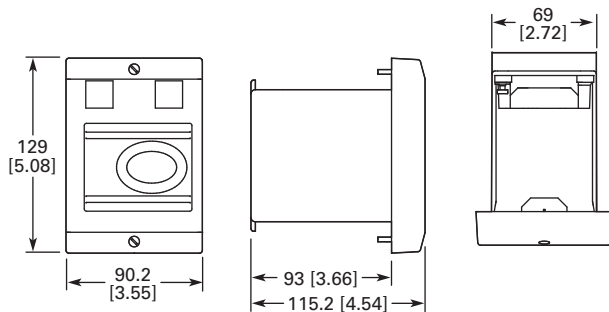

XTPBXENCF40, XTPBXENCF55

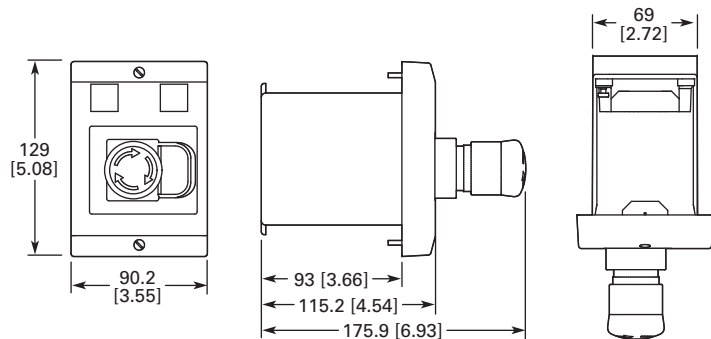

XTPBXENCFEK55, XTPBXENCSES55

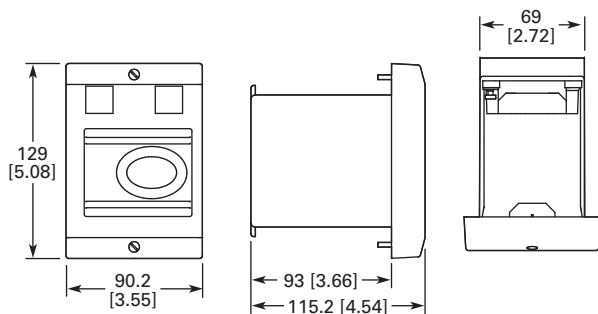

XTPBXENCFL65, XTPBXENCFL055

Approximate Dimensions in mm [in]

Insulated Enclosures for Surface Mounting of XTPR...B Manual Motor Protectors

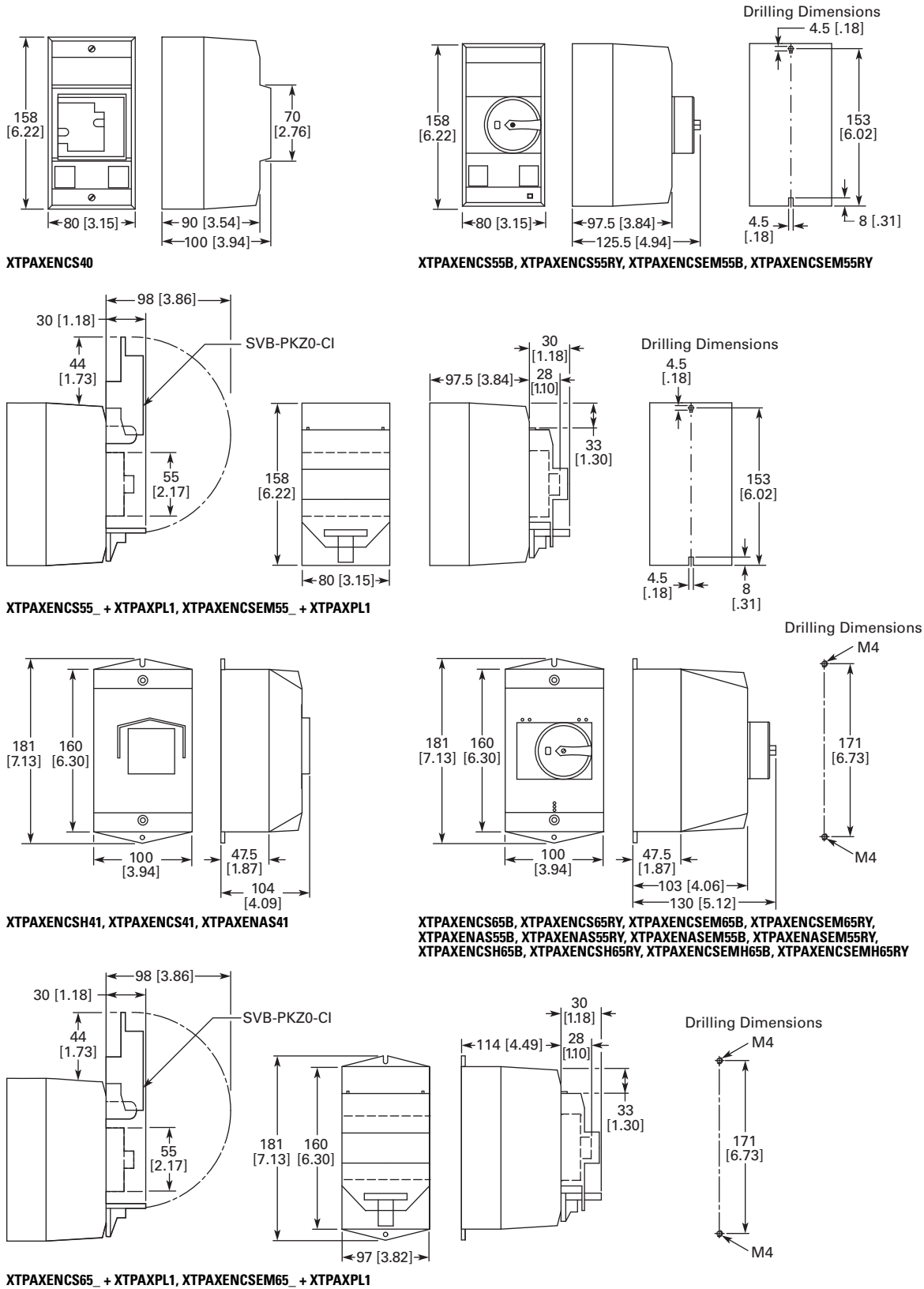

# 1.1

## IEC Contactors and Starters

### XT IEC Power Control

1

Approximate Dimensions in mm [in]

#### Insulated Enclosures for Flush Mounting of XTPR...B Manual Motor Protectors

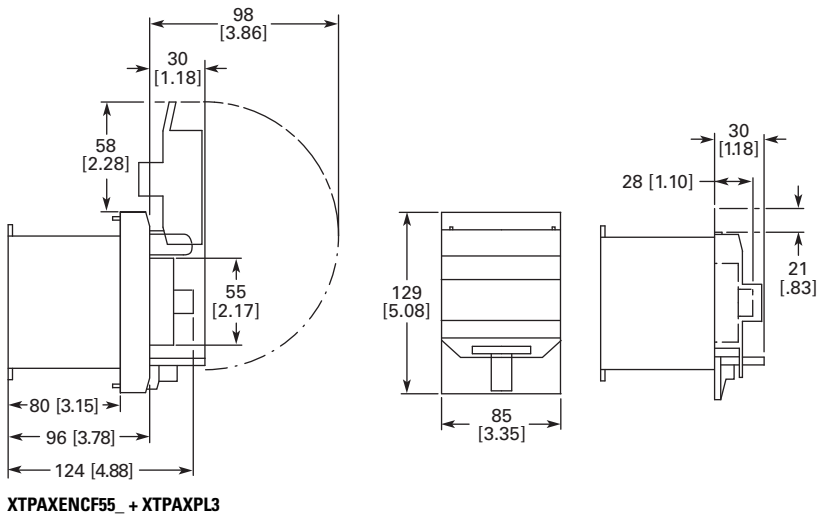
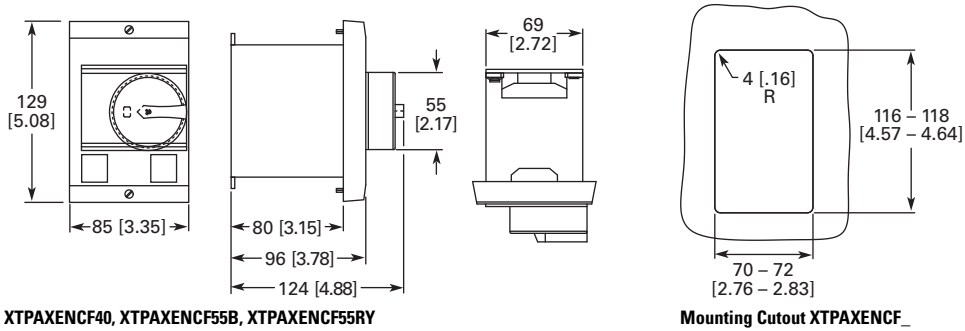

Approximate Dimensions in mm [in]

**Insulated Enclosures for Surface Mounting of XTPR...D Manual Motor Protectors**

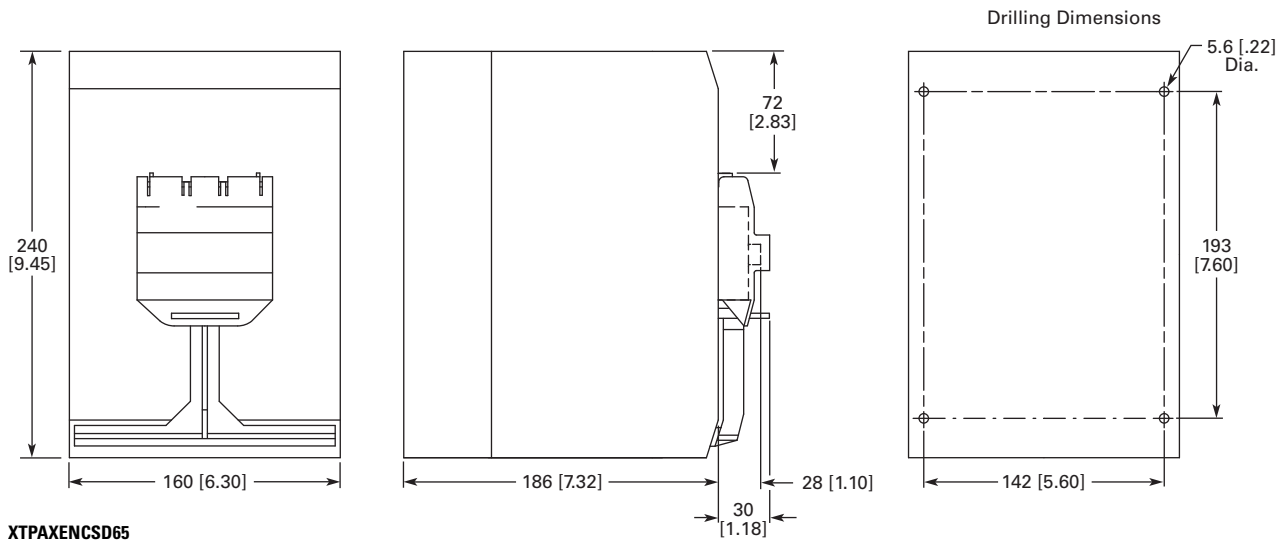
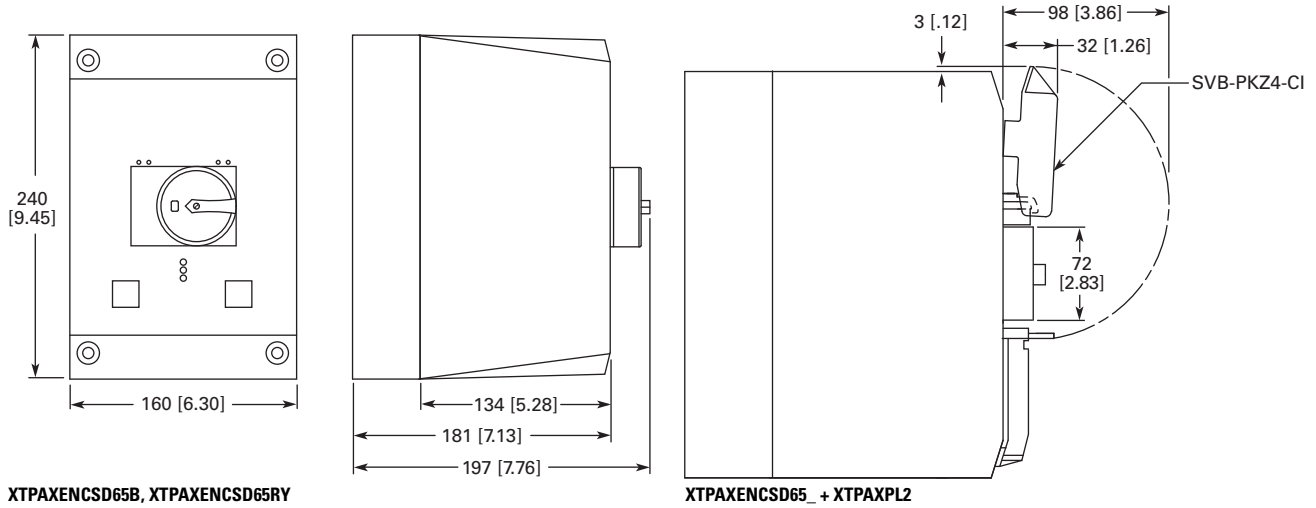

**Rotary Handle Mechanism—XTPAXRHM\_**

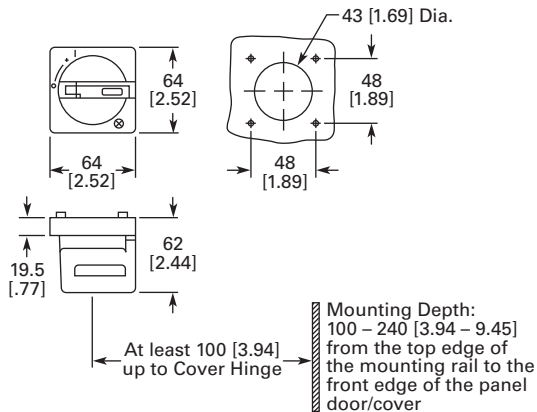

Approximate Dimensions in mm [in]

**Pushbutton MMP Enclosures****Insulated Enclosures for Surface Mounting****XTPB Pushbutton Motor-Protective Circuit Breakers**

Catalog Number	H x W x D
<b>Global Usage</b>	
<b>XTPBXENC540</b>	158 x 80 x 116.5 [6.22 x 3.15 x 4.59]
<b>XTPBXENC65</b>	158 x 80 x 116.5 [6.22 x 3.15 x 4.59]
<b>XTPBXENC5L065</b>	158 x 80 x 129.5 [6.22 x 3.15 x 5.10]
<b>XTPBXENC5LE65</b>	158 x 80 x 129.5 [6.22 x 3.15 x 5.10]
<b>XTPBXENC5ES65</b>	158 x 80 x 177.2 [6.22 x 3.15 x 6.98]
<b>XTPBXENC5EK65</b>	158 x 80 x 177.2 [6.22 x 3.15 x 6.98]

**XTPB Pushbutton Manual Motor Protectors**

Catalog Number	H x W x D
<b>North American Usage</b>	
<b>XTPBXENAS41</b>	158 x 80 x 116.5 [6.22 x 3.15 x 4.59]
<b>XTPBXENAS65</b>	158 x 80 x 116.5 [6.22 x 3.15 x 4.59]
<b>XTPBXENASL065</b>	158 x 80 x 129.5 [6.22 x 3.15 x 5.10]
<b>XTPBXENASLE65</b>	158 x 80 x 129.5 [6.22 x 3.15 x 5.10]
<b>XTPBXENASES65</b>	158 x 80 x 177.2 [6.22 x 3.15 x 6.98]
<b>XTPBXENASEK65</b>	158 x 80 x 177.2 [6.22 x 3.15 x 6.98]

**Frame B (0.1–32A) XTPR Motor-Protective Circuit Breakers**

Catalog Number	H x W x D
<b>Global Usage</b>	
<b>XTPAXENC541</b>	160 x 100 x 104 [6.30 x 3.94 x 4.09]
<b>XTPAXENC65B</b>	160 x 100 x 130 [6.30 x 3.94 x 5.12]
<b>XTPAXENC65RY</b>	160 x 100 x 130 [6.30 x 3.94 x 5.12]
<b>XTPAXENC540</b>	158 x 80 x 100 [6.22 x 3.15 x 3.94]
<b>XTPAXENC55B</b>	158 x 80 x 125.5 [6.22 x 3.15 x 4.94]
<b>XTPAXENC55RY</b>	158 x 80 x 125.5 [6.22 x 3.15 x 4.94]

**Frame B (0.1–32A) XTPR Rotary Manual Motor Protectors**

Catalog Number	H x W x D
<b>North American Usage</b>	
<b>XTPAXENAS55B</b>	160 x 100 x 130 [6.30 x 3.94 x 5.12]
<b>XTPAXENAS55RY</b>	160 x 100 x 130 [6.30 x 3.94 x 5.12]

**Frame B XTPR (0.1–32A) Rotary Motor-Protective Circuit Breakers with XTPAXFAEM20 Early-Make Front-Mount Auxiliary Contact**

Catalog Number	H x W x D
<b>Global Usage</b>	
<b>XTPAXENCSEM65B</b>	160 x 100 x 130 [6.30 x 3.94 x 5.12]
<b>XTPAXENCSEM65RY</b>	160 x 100 x 130 [6.30 x 3.94 x 5.12]
<b>XTPAXENCSEM55B</b>	158 x 80 x 100 [6.22 x 3.15 x 3.94]
<b>XTPAXENCSEM55RY</b>	158 x 80 x 100 [6.22 x 3.15 x 3.94]

**Frame B XTPR (0.1–32A) Rotary Manual Motor Protectors with XTPAXFAEM20 Early-Make Front-Mount Auxiliary Contact**

Catalog Number	H x W x D
<b>North American Usage</b>	
<b>XTPAXENCSEM55B</b>	160 x 100 x 130 [6.30 x 3.94 x 5.12]
<b>XTPAXENCSEM55RY</b>	160 x 100 x 130 [6.30 x 3.94 x 5.12]

**Frame D (10–65A) Rotary Motor-Protective Circuit Breakers**

Catalog Number	H x W x D
<b>Global and North American Usage</b>	
<b>XTPAXENCSD65B</b>	240 x 160 x 197 [9.45 x 6.30 x 7.76]
<b>XTPAXENCSD65RY</b>	240 x 160 x 197 [9.45 x 6.30 x 7.76]

**Insulated Enclosures for Flush Mounting****XTPB Pushbutton Manual Motor Protectors**

Catalog Number	H x W x D
<b>Global and North American Usage</b>	
<b>XTPBXENC40</b>	129 x 90.2 x 115.2 [5.08 x 3.55 x 4.54]
<b>XTPBXENC55</b>	129 x 90.2 x 115.2 [5.08 x 3.55 x 4.54]
<b>XTPBXENC5FLO55</b>	129 x 90.2 x 115.2 [5.08 x 3.55 x 4.54]
<b>XTPBXENC5FLE55</b>	129 x 90.2 x 115.2 [5.08 x 3.55 x 4.54]
<b>XTPBXENC5FES55</b>	129 x 90.2 x 175.9 [5.08 x 3.55 x 6.93]
<b>XTPBXENC5FEK55</b>	129 x 90.2 x 175.9 [5.08 x 3.55 x 6.93]

**Frame B (0.1–32A) XTPR Rotary Manual Motor Protectors**

Catalog Number	H x W x D
<b>Global Usage</b>	
<b>XTPAXENC40</b>	129 x 85 x 96 [5.08 x 3.35 x 3.78]
<b>XTPAXENC55B</b>	129 x 85 x 124 [5.08 x 3.35 x 4.88]
<b>XTPAXENC55RY</b>	129 x 85 x 124 [5.08 x 3.35 x 4.88]



## Combination Motor Controllers



## Combination Motor Controllers

## Product Description

Eaton's **XT** IEC open non-reversing and reversing manual motor controllers combine a manual motor protector with an IEC contactor(s) to provide a complete motor protection solution by combining motor disconnect function, thermal overload protection, magnetic short-circuit protection and remote control operation in one compact, assembled unit. These assembled manual motor controllers cover motors with FLA ratings from 0.10A to 65A.

The UL 508 Type F labeled combination motor controller (CMC) includes a line side adapter (LSA). These assembled combination motor controllers cover motors with FLA ratings from 0.10A to 65A.

## Application Description

The **XT** IEC non-reversing and reversing manual and combination motor controllers can be used in the following applications:

**Group Motor Control**

Manual motor controllers (MMCs) are ideal for group motor applications where an upstream breaker or fuse provides protection for two or more motors. **XT** manual motor controllers (MMC) combine a manual motor protector, a wiring connector link and IEC contactor.

## Contents

<b>Description</b>	<b>Page</b>
Relays and Timers . . . . .	<b>V5-T1-3</b>
Miniature Controls . . . . .	<b>V5-T1-18</b>
Contactors and Starters . . . . .	<b>V5-T1-35</b>
Thermal Overload Relays . . . . .	<b>V5-T1-128</b>
C440/ <b>XT</b> Electronic Overload Relay . . . . .	<b>V5-T1-141</b>
Manual Motor Protectors . . . . .	<b>V5-T1-157</b>
Combination Motor Controllers	
Features . . . . .	<b>V5-T1-194</b>
Standards and Certifications . . . . .	<b>V5-T1-194</b>
Catalog Number Selection . . . . .	<b>V5-T1-195</b>
Product Selection . . . . .	<b>V5-T1-195</b>
Accessories . . . . .	<b>V5-T1-203</b>
Technical Data and Specifications . . . . .	<b>V5-T1-205</b>
Dimensions . . . . .	<b>V5-T1-211</b>
 An Eaton Green Solution	
<b>XT</b> Electronic Manual Motor Protector . . . . .	<b>V5-T1-216</b>
Reference Data . . . . .	<b>V5-T1-229</b>

**Individual Branch Circuit for Motor Loads**

Combination motor controller (CMC), consisting of a line side adapter, manual motor protector, wiring connector link and IEC contactor, provide an efficient means to build an entire branch circuit. The **XT** CMC is UL 508 Type F approved, meaning it is "self-protected" and doesn't require the use of an additional fuse or breaker for short circuit protection. This approval means CMC's can be used in place of a traditional fuse-starter and breaker-starter motor circuit.

Based around two key functional components (MMP and contactor), the CMC is a very cost effective means to build a branch circuit. Fuses and breakers must be oversized to prevent tripping during motor start up, and thus these oversized devices can no longer protect the motor. To compensate for this, a motor overload relay is necessary to protect the motor.

The manual motor protector was invented in Germany by Moeller to correct this inefficiency. The MMP operates similarly to a circuit breaker, except the inrush (magnetic) protection is set to 14 times the running current, thus accounting for motor start-up current without the necessity to oversize. A overcurrent dial was added to the face of the MMP to serve as the motor overload protection. This "motor protective circuit breaker", as it is referred to in Europe, now accomplishes all four key functions of a motor branch circuit: disconnect, short circuit, motor controller and motor overload protection. With the addition of a contactor, users have the ability to remotely control the starter device.

Whether a single motor application or a multiple motor application, CMC's are an ideal solution for machinery OEMs and panel builders.

1

### Features

- ON/OFF rotary handle with lockout provision
- Visible trip indication
- Test trip function
- Motor applications from 0.10A to 65A
- Class 10 overload protection
- Built-in heater and magnetic trip elements to protect the motor
- Phase loss sensitivity
- Type 2 coordination
- Ambient compensated up to 55°C [140°F]
- Control inputs located at front of starter for easy access and wiring
- Wide range of coils
- DIN rail mount—XTSC...BB\_
- Mounting plates—XTSC...BC\_, XTSC...D motor controllers
- Adjustment dial for setting motor FLA
- Short-circuit trip at 14 times the maximum setting of the FLA adjustment dial
- UL 508 Type F CMC high fault short-circuit ratings
- 1NO-1NC auxiliary contact as standard on manual motor controller and combination motor controller

### Standards and Certifications

UL 508 Type F combination motor controller

- IEC Type 2 Approved per IEC 60947-4-1
- UL Listed File No. E245398
- CE Mark



**Note:** For Type 2 Coordination of MMCs, see **Page V5-T1-230**. Protection in different controller types

### MMC and CMC Applications

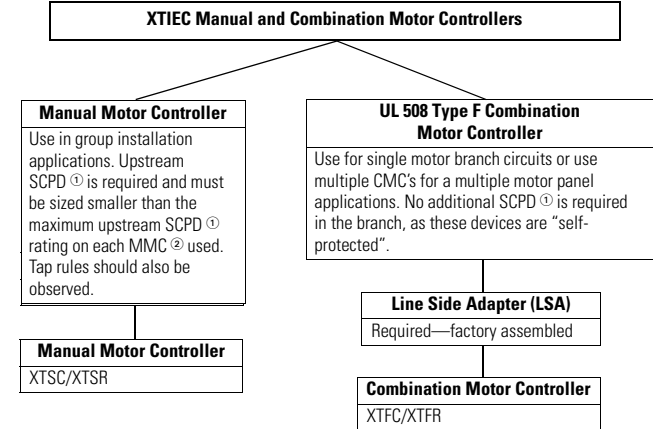

#### Notes

Technical Paper AP03402001E.

Line side adapters are not required for non-U.S. applications. Most countries outside of the U.S. classify the MMP as a motor-protective circuit breaker.

<sup>①</sup> SCPD = Short-circuit protective device (circuit breaker, fuses).

<sup>②</sup> MMC = Manual motor controller

Catalog Number Selection

Combination Motor Controllers

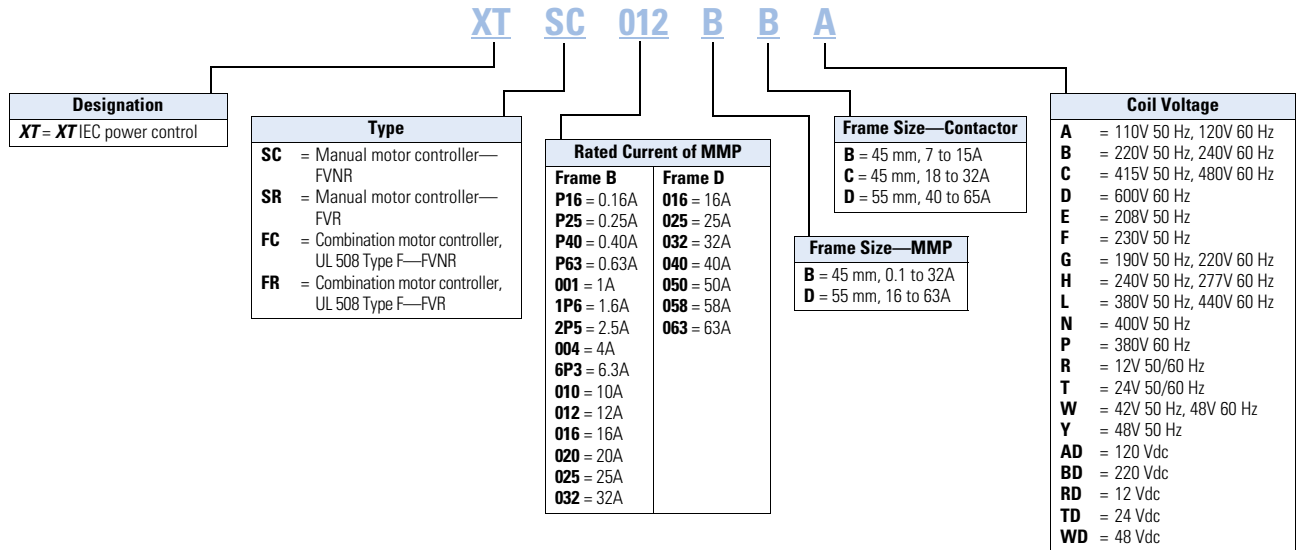

Product Selection

XTSC and XTSR Manual Motor Controllers (MMC)/Starter Combinations

Frame B MMP + Frame B Contactor



Factory-Assembled Manual Motor Controller—Frame B MMP + Frame B Contactor—Maximum UL Ratings ①

FLA Adjustment Range/Overload Release— $I_r$  (Amps)



FLA Adjustment Range/Overload Release— $I_r$ (Amps)	Short-Circuit Release— $I_{rm}$ (Amps)	Three-Phase				Assembled Manual Motor Controller ②	
		200V	240V	480V	600V	Non-Reversing Catalog Number	Reversing Catalog Number
0.1–0.16	3.2	③	③	1/2	1/2	XTSCP16BB_	XTSRP16BB_
0.16–0.25	3.5	③	③	1/2	1/2	XTSCP25BB_	XTSRP25BB_
0.25–0.4	5.6	③	③	1/2	1/2	XTSCP40BB_	XTSRP40BB_
0.4–0.63	8.82	③	③	1/2	1/2	XTSCP63BB_	XTSRP63BB_
0.63–1	14	③	③	1/2	1/2	XTSC001BB_	XTSR001BB_
1–1.6	22.4	③	③	3/4	1	XTSC1P6BB_	XTSR1P6BB_
1.6–2.5	35	1/2	1/2	1	1-1/2	XTSC2P5BB_	XTSR2P5BB_
2.5–4	56	1	1	2	3	XTSC004BB_	XTSR004BB_
4–6.3	88.2	1-1/2	1-1/2	3	5	XTSC6P3BB_	XTSR6P3BB_
6.3–10	140	3	3	7-1/2	3	XTSC010BB_	XTSR010BB_
8–12	168	3	3	7-1/2	3	XTSC012BB_	XTSR012BB_
10–16	224	3	3	10	3	XTSC016BB_	—

Notes

- ① Select manual motor controllers by full load amperes. Maximum motor ratings (kW, hp) are for reference only.
- ② Underscore ( \_ ) indicates magnetic coil suffix required. See Page V5-T1-198.
- ③ In this range, calculate motor rating according to rated current. Specified values to NEC 430.6(A)(1).

1

Frame B MMP +  
Frame B Contactor



#### Factory-Assembled Motor Protective Device with Thermal and Magnetic Trip + Contactor— Maximum IEC Ratings<sup>①</sup>

FLA Adjustment  
Range/Overload  
Release— $I_r$   
(Amps)



FLA Adjustment Range/Overload Release— $I_r$ (Amps)	Short-Circuit Release— $I_m$ (Amps)	Three-Phase				Assembled Manual Motor Controller <sup>②</sup>	
		220– 240V	380– 415V	500V	660– 690V	Non-Reversing Catalog Number	Reversing Catalog Number
0.1–0.16	3.2	—	—	—	0.06	XTSCP16BB_	XTSRP16BB_
0.16–0.25	3.5	—	0.06	0.06	0.12	XTSCP25BB_	XTSRP25BB_
0.25–0.4	5.6	0.06	0.09	0.12	0.18	XTSCP40BB_	XTSRP40BB_
0.4–0.63	8.82	0.09	0.18	0.25	0.25	XTSCP63BB_	XTSRP63BB_
0.63–1	14	0.12	0.25	0.37	0.55	XTSC001BB_	XTSR001BB_
1–1.6	22.4	0.25	0.55	0.75	1.1	XTSC1P6BB_	XTSR1P6BB_
1.6–2.5	35	0.37	0.75	1.1	1.5	XTSC2P5BB_	XTSR2P5BB_
2.5–4	56	0.75	1.5	2.2	3	XTSC004BB_	XTSR004BB_
4–6.3	88.2	1.1	2.2	3	4	XTSC6P3BB_	XTSR6P3BB_
6.3–10	140	2.2	4	4	7.5	XTSC010BB_	XTSR010BB_
8–12	168	3	5.5	5.5	11	XTSC012BB_	XTSR012BB_
10–16	224	4	7.5	9	12.5	XTSC016BB_	—

Frame B MMP +  
Frame C Contactor



#### Factory-Assembled Manual Motor Controller—Frame B MMP + Frame C Contactor— Maximum UL Ratings<sup>①</sup>

FLA Adjustment  
Range/Overload  
Release— $I_r$   
(Amps)



FLA Adjustment Range/Overload Release— $I_r$ (Amps)	Short-Circuit Release— $I_m$ (Amps)	Three-Phase				Assembled Manual Motor Controller <sup>②</sup>	
		200V	240V	480V	600V	Non-Reversing Catalog Number	Reversing Catalog Number
10–16	224	3	3	10	10	XTSC016BC_	XTSR016BC_
16–20	280	5	5	10	15	XTSC020BC_	XTSR020BC_
20–25	350	5	7-1/2	15	20	XTSC025BC_	XTSR025BC_
25–32	448	7-1/2	10	20	25	XTSC032BC_	XTSR032BC_

Frame B MMP +  
Frame C Contactor



#### Factory-Assembled Manual Motor Controller—Frame B MMP + Frame C Contactor— Maximum IEC Ratings<sup>①</sup>

FLA Adjustment  
Range/Overload  
Release— $I_r$   
(Amps)



FLA Adjustment Range/Overload Release— $I_r$ (Amps)	Short-Circuit Release— $I_m$ (Amps)	Three-Phase				Assembled Manual Motor Controller <sup>②</sup>	
		220– 240V	380– 415V	500V	660– 690V	Non-Reversing Catalog Number	Reversing Catalog Number
10–16	224	4	7.5	9	12.5	XTSC016BC_	XTSR016BC_
16–20	280	5.5	9	12.5	15	XTSC020BC_	XTSR020BC_
20–25	350	5.5	11	15	22	XTSC025BC_	XTSR025BC_
25–32	448	7.5	15	22	30	XTSC032BC_	XTSR032BC_

#### Notes

- ① Select manual motor controllers by full load amperes. Maximum motor ratings (kW, hp) are for reference only.
- ② Underscore (\_) indicates magnetic coil suffix required. See **Page V5-T1-198**.

Frame D MMP +  
Frame C ContactorFactory-Assembled Manual Motor Controller—Frame D MMP + Frame C Contactor—  
Maximum UL Ratings ①FLA Adjustment  
Range/Overload  
Release— $I_r$   
(Amps)

	Short-Circuit Release— $I_{rm}$ (Amps)	Three-Phase				Assembled Manual Motor Controller ②	
		200V	240V	480V	600V	Non-Reversing Catalog Number	Reversing Catalog Number
10–16	224	3	5	10	15	XTSC016DC_	XTSR016DC_
16–25	350	5	7-1/2	15	20	XTSC025DC_	XTSR025DC_
25–32	448	7-1/2	10	20	30	XTSC032DC_	XTSR032DC_

Frame D MMP +  
Frame C ContactorFactory-Assembled Manual Motor Controller—Frame D MMP + Frame C Contactor—  
Maximum IEC Ratings ①FLA Adjustment  
Range/Overload  
Release— $I_r$   
(Amps)

	Short-Circuit Release— $I_{rm}$ (Amps)	Three-Phase				Assembled Manual Motor Controller ②	
		220– 240V	380– 415V	500V	660– 690V	Non-Reversing Catalog Number	Reversing Catalog Number
10–16	224	4	7.5	9	12.5	XTSC016DC_	XTSR016DC_
16–25	350	5.5	12.5	12.5	22	XTSC025DC_	XTSR025DC_
25–32	448	7.5	15	17.5	22	XTSC032DC_	XTSR032DC_

Frame D MMP +  
Frame D ContactorFactory-Assembled Manual Motor Controller—Frame D MMP + Frame D Contactor—  
Maximum UL Ratings ①FLA Adjustment  
Range/Overload  
Release— $I_r$   
(Amps)

	Short-Circuit Release— $I_{rm}$ (Amps)	Three-Phase				Assembled Manual Motor Controller ②	
		200V	240V	480V	600V	Non-Reversing Catalog Number	Reversing Catalog Number
32–40	560	10	15	30	30	XTSC040DD_	XTSR040DD_
40–50	700	15	15	30	—	XTSC050DD_	XTSR050DD_
50–58	812	15	15	40	—	XTSC058DD_	XTSR058DD_
55–65	882	15	15	40	—	XTSC063DD_	XTSR063DD_

**Notes**

- ① Select manual motor controllers by full load amperes. Maximum motor ratings (kW, hp) are for reference only.  
 ② Underscore (\_) indicates magnetic coil suffix required. See **Page V5-T1-198**.

**Frame D MMP +  
Frame D Contactor**



**Factory-Assembled Manual Motor Controller—Frame D MMP + Frame D Contactor—  
Maximum IEC Ratings ①**

**FLA Adjustment  
Range/Overload  
Release— $I_r$   
(Amps)**



	Short-Circuit Release— $I_m$ (Amps)	Three-Phase				Assembled Manual Motor Controller ②	
		220– 240V	380– 415V	500V	660– 690V	Non-Reversing Catalog Number	Reversing Catalog Number
32–40	560	11	20	22	30	<b>XTSC040DD_</b>	<b>XTSR040DD_</b>
40–50	700	14	25	30	45	<b>XTSC050DD_</b>	<b>XTSR050DD_</b>
50–58	812	17	30	37	55	<b>XTSC058DD_</b>	<b>XTSR058DD_</b>
55–65	882	18.5	34	37	55	<b>XTSC063DD_</b>	<b>XTSR063DD_</b>

**AC and DC Coil Suffixes**

Coil Voltage	Suffix Code
<b>Frame B Contactors</b>	
110V 50 Hz, 120V 60 Hz	<b>A</b>
220V 50 Hz, 240V 60 Hz	<b>B</b>
230V 50 Hz	<b>F</b>
24V 50/60 Hz	<b>T</b>
24 Vdc	<b>TD</b> ③
415V 50 Hz, 480V 60 Hz	<b>C</b>
600V 60 Hz	<b>D</b>
208V 60 Hz	<b>E</b>
190V 50 Hz, 220V 60 Hz	<b>G</b>
240V 50 Hz, 277V 60 Hz	<b>H</b>

Coil Voltage	Suffix Code
380V 50 Hz, 440V 60 Hz	<b>L</b>
400V 50 Hz	<b>N</b>
380V 60 Hz	<b>P</b>
12V 50/60 Hz	<b>R</b>
42V 50 Hz, 48V 60 Hz	<b>W</b>
48V 50 Hz	<b>Y</b>
120 Vdc	<b>AD</b> ③
220 Vdc	<b>BD</b> ③
12 Vdc	<b>RD</b> ③
48 Vdc	<b>WD</b> ③

Coil Voltage	Suffix Code
<b>Frame C and D Contactors</b>	
110V 50 Hz, 120V 60 Hz	<b>A</b>
220V 50 Hz, 240V 60 Hz	<b>B</b>
230V 50 Hz	<b>F</b>
24V 50/60 Hz	<b>T</b>
24–27 Vdc	<b>TD</b> ③
415V 50 Hz, 480V 60 Hz	<b>C</b>
550V 50 Hz, 600V 60 Hz	<b>D</b>
208V 60 Hz	<b>E</b>
190V 50 Hz, 220V 60 Hz	<b>G</b>
240V 50 Hz, 277V 60 Hz	<b>H</b>

Coil Voltage	Suffix Code
380V 50 Hz, 440V 60 Hz	<b>L</b>
400V 50 Hz	<b>N</b>
380V 60 Hz	<b>P</b>
12V 50/60 Hz	<b>R</b>
42V 50 Hz, 48V 60 Hz	<b>W</b>
48V 50 Hz	<b>Y</b>
110–130 Vdc	<b>AD</b> ③
200–240 Vdc	<b>BD</b> ③
12–14 Vdc	<b>RD</b> ③
48–60 Vdc	<b>WD</b> ③

**Notes**

The assembled manual motor controller (MMC) consists of an XTPR manual motor protector (MMP) and an XTCE contactor. For Frame B MMP + Frame B contactor assemblies, the XTSC and XTSR can be mounted directly on DIN rail without an adapter. The contactors are supported mechanically with a mechanical connection element (included in XTPAXTPCB, XTPAXRPCR). For MMCs using a Frame C or Frame D contactor, the assembly is mounted via a DIN rail adapter plate (XTPAXTPCPC, XTPAXTPCPD) and the electrical connection is made with electrical contact modules (XTPAXECMC, XTPAXECMD), both included in XTPAXTPCC and XTPAXTPCD.

Service Factor (SF)—Setting  $I_r$  of current scale in dependence of load factor:

$$SF = 1.15 \rightarrow I_r = 1 \times I_{n \text{ mot}}$$

$$SF = 1 \rightarrow I_r = 0.9 \times I_{n \text{ mot}}$$

Single-phasing sensitivity to IEC/EN 60947-4-1, VDE 0660 Part 102.

- ① Select manual motor controllers by full load amperes. Maximum motor ratings (kW, hp) are for reference only.
- ② Underscore (\_) indicates magnetic coil suffix required. See AC and DC coil suffixes above.
- ③ With DC operation: Integrated diode-resistor combination, coil rating 2.6W.

**Non-Reversing Manual  
Motor Controller Power  
Circuit**

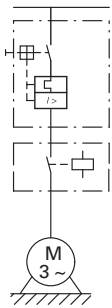

**Reversing Manual  
Motor Controller Power  
Circuit**

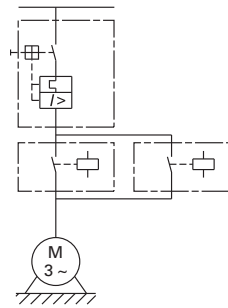

## XTFC and XTFR Combination Motor Controllers (CMC), UL 508 Type F

Frame B MMP + Two  
Frame B ContactorsFactory-Assembled Type F Combination Motor Controller—Frame B MMP + Frame B Contactor—  
Maximum UL Ratings <sup>①</sup>FLA Adjustment  
Range/Overload  
Release— $I_r$   
(Amps)

FLA Adjustment Range/Overload Release— $I_r$ (Amps)	Short-Circuit Release— $I_m$ (Amps)	Three-Phase				Assembled Manual Motor Controller <sup>②</sup>	
		200V	240V	480V	600V	Non-Reversing Catalog Number	Reversing Catalog Number
0.16–0.25	3.5	③	③	1/2	1/2	XTFCP25BB_	XTFRP25BB_
0.25–0.4	5.6	③	③	1/2	1/2	XTFCP40BB_	XTFRP40BB_
0.4–0.63	8.82	③	③	1/2	1/2	XTFCP63BB_	XTFRP63BB_
0.63–1	14	③	③	1/2	1/2	XTFC001BB_	XTFR001BB_
1–1.6	22.4	③	③	3/4	1	XTFC1P6BB_	XTFR1P6BB_
1.6–2.5	35	1/2	1/2	1	1-1/2	XTFC2P5BB_	XTFR2P5BB_
2.5–4	56	1	1	2	3	XTFC004BB_	XTFR004BB_
4–6.3	88.2	1-1/2	1-1/2	3	5	XTFC6P3BB_	XTFR6P3BB_
6.3–10	140	3	3	7-1/2	10	XTFC010BB_	XTFR010BB_
8–12	168	3	3	7-1/2	—	XTFC012BB_	XTFR012BB_
10–16	224	3	5	10	—	XTFC016BB_	—

Factory-Assembled Type F Combination Motor Controller—Frame B MMP + Frame B Contactor—  
Maximum IEC Ratings <sup>①</sup>FLA Adjustment  
Range/Overload  
Release— $I_r$   
(Amps)

FLA Adjustment Range/Overload Release— $I_r$ (Amps)	Short-Circuit Release— $I_m$ (Amps)	Three-Phase				Assembled Manual Motor Controller <sup>②</sup>	
		220– 240V	380– 415V	500V	660– 690V	Non-Reversing Catalog Number	Reversing Catalog Number
0.1–0.16	2.2	—	—	—	0.06	XTFCP16BB_	XTFRP16BB_
0.16–0.25	3.5	—	0.06	0.06	0.12	XTFCP25BB_	XTFRP25BB_
0.25–0.4	5.6	0.06	0.09	0.12	0.18	XTFCP40BB_	XTFRP40BB_
0.4–0.63	8.82	0.09	0.18	0.25	0.25	XTFCP63BB_	XTFRP63BB_
0.63–1	14	0.12	0.25	0.37	0.55	XTFC001BB_	XTFR001BB_
1–1.6	22.4	0.25	0.55	0.75	1.1	XTFC1P6BB_	XTFR1P6BB_
1.6–2.5	35	0.37	0.75	1.1	1.5	XTFC2P5BB_	XTFR2P5BB_
2.5–4	56	0.75	1.5	2.2	3	XTFC004BB_	XTFR004BB_
4–6.3	88.2	1.1	2.2	3	4	XTFC6P3BB_	XTFR6P3BB_
6.3–10	140	2.2	4	4	7.5	XTFC010BB_	XTFR010BB_
8–12	168	3	5.5	5.5	11	XTFC012BB_	XTFR012BB_
10–16	224	4	7.5	9	12.5	XTFC016BB_	—

**Notes**

- ① Select combination motor controllers by full load amperes. Maximum motor ratings (kW, hp) are for reference only.  
 ② Underscore ( \_ ) indicates magnetic coil suffix required. See **Page V5-T1-202**.  
 ③ In this range, calculate motor rating according to rated current. Specified values to NEC 430.6(A)(1).

#### Factory-Assembled Type F Combination Motor Controller—Frame B MMP + Frame C Contactor—Maximum UL Ratings <sup>①</sup>

FLA Adjustment  
Range/Overload  
Release— $I_r$   
(Amps)

	Short-Circuit Release— $I_m$ (Amps)	Three-Phase				Assembled Manual Motor Controller <sup>②</sup>	
		200V	240V	480V	600V	Non-Reversing Catalog Number	Reversing Catalog Number
10–16	224	3	5	10	—	XTFC016BC_	XTFR016BC_
16–20	280	5	5	—	—	XTFC020BC_	XTFR020BC_
20–25	350	5	7-1/2	15	—	XTFC025BC_	XTFR025BC_
25–32	448	7-1/2	10	20	—	XTFC032BC_	XTFR032BC_

#### Factory-Assembled Type F Combination Motor Controller—Frame B MMP + Frame C Contactor—Maximum IEC Ratings <sup>①</sup>

FLA Adjustment  
Range/Overload  
Release— $I_r$   
(Amps)

	Short-Circuit Release— $I_m$ (Amps)	Three-Phase				Assembled Manual Motor Controller <sup>②</sup>	
		220– 240V	380– 415V	500V	660– 690V	Non-Reversing Catalog Number	Reversing Catalog Number
10–16	224	4	7.5	9	12.5	XTFC016BC_	XTFR016BC_
16–20	280	5.5	9	12.5	15	XTFC020BC_	XTFR020BC_
20–25	350	5.5	11	15	22	XTFC025BC_	XTFR025BC_
25–32	448	7.5	15	22	30	XTFC032BC_	XTFR032BC_

**Notes**

- ① Select combination motor controllers by full load amperes. Maximum motor ratings (kW, hp) are for reference only.
- ② Underscore (\_) indicates magnetic coil suffix required. See **Page V5-T1-202**.



### Factory-Assembled Type F Combination Motor Controller—Frame D MMP + Frame C Contactor—Maximum UL Ratings <sup>①</sup>

FLA Adjustment  
Range/Overload  
Release— $I_r$   
(Amps)

	Short-Circuit Release— $I_m$ (Amps)	Three-Phase				Assembled Manual Motor Controller <sup>②</sup>	
		200V	240V	480V	600V	Non-Reversing Catalog Number	Reversing Catalog Number
10–16	224	3	5	10	10	XTFC016DC_	XTFR016DC_
16–25	350	5	7-1/2	15	20	XTFC025DC_	XTFR025DC_
25–32	448	7-1/2	10	25	30	XTFC032DC_	XTFR032DC_

### Factory-Assembled Type F Combination Motor Controller—Frame D MMP + Frame C Contactor—Maximum IEC Ratings <sup>①</sup>

FLA Adjustment  
Range/Overload  
Release— $I_r$   
(Amps)

	Short-Circuit Release— $I_m$ (Amps)	Three-Phase				Assembled Manual Motor Controller <sup>②</sup>	
		220– 240V	380– 415V	500V	660– 690V	Non-Reversing Catalog Number	Reversing Catalog Number
10–16	224	4	7.5	9	12.5	XTFC016DC_	XTFR016DC_
16–25	350	5.5	12.5	12.5	22	XTFC025DC_	XTFR025DC_
25–32	448	7.5	15	17.5	22	XTFC032DC_	XTFR032DC_

### Factory-Assembled Type F Combination Motor Controller—Frame D MMP + Frame D Contactor—Maximum UL Ratings <sup>①</sup>

FLA Adjustment  
Range/Overload  
Release— $I_r$   
(Amps)

	Short-Circuit Release— $I_m$ (Amps)	Three-Phase				Assembled Manual Motor Controller <sup>②</sup>	
		200V	240V	480V	600V	Non-Reversing Catalog Number	Reversing Catalog Number
32–40	560	10	15	30	30	XTFC040DD_	XTFR040DD_
40–50	700	10	15	30	—	XTFC050DD_	XTFR050DD_
50–58	812	15	15	40	—	XTFC058DD_	XTFR058DD_
55–65	882	15	15	40	—	XTFC063DD_	XTFR063DD_

#### Notes

- <sup>①</sup> Select combination motor controllers by full load amperes. Maximum motor ratings (kW, hp) are for reference only.  
<sup>②</sup> Underscore ( \_ ) indicates magnetic coil suffix required. See **Page V5-T1-202**.

#### Factory-Assembled Type F Combination Motor Controller—Frame D MMP + Frame D Contactor—Maximum IEC Ratings <sup>①</sup>

**FLA Adjustment Range/Overload Release— $I_r$  (Amps)**



	Short-Circuit Release— $I_m$ (Amps)	Three-Phase				Assembled Manual Motor Controller <sup>②</sup>	
		220–240V	380–415V	500V	660–690V	Non-Reversing Catalog Number	Reversing Catalog Number
32–40	560	11	20	22	30	<b>XTFC040DD_</b>	<b>XTFR040DD_</b>
40–50	700	14	25	30	45	<b>XTFC050DD_</b>	<b>XTFR050DD_</b>
50–58	812	17	30	37	55	<b>XTFC058DD_</b>	<b>XTFR058DD_</b>
55–65	882	18.5	34	37	55	<b>XTFC063DD_</b>	<b>XTFR063DD_</b>

#### AC and DC Coil Suffixes

Coil Voltage	Suffix Code
<b>Frame B Contactors</b>	
110V 50 Hz, 120V 60 Hz	<b>A</b>
220V 50 Hz, 240V 60 Hz	<b>B</b>
230V 50 Hz	<b>F</b>
24V 50/60 Hz	<b>T</b>
24 Vdc	<b>TD</b> <sup>③</sup>
415V 50 Hz, 480V 60 Hz	<b>C</b>
600V 60 Hz	<b>D</b>
208V 60 Hz	<b>E</b>
190V 50 Hz, 220V 60 Hz	<b>G</b>
240V 50 Hz, 277V 60 Hz	<b>H</b>

Coil Voltage	Suffix Code
380V 50 Hz, 440V 60 Hz	<b>L</b>
400V 50 Hz	<b>N</b>
380V 60 Hz	<b>P</b>
12V 50/60 Hz	<b>R</b>
42V 50 Hz, 48V 60 Hz	<b>W</b>
48V 50 Hz	<b>Y</b>
120 Vdc	<b>AD</b> <sup>③</sup>
220 Vdc	<b>BD</b> <sup>③</sup>
12 Vdc	<b>RD</b> <sup>③</sup>
48 Vdc	<b>WD</b> <sup>③</sup>

Coil Voltage	Suffix Code
<b>Frame C and D Contactors</b>	
110V 50 Hz, 120V 60 Hz	<b>A</b>
220V 50 Hz, 240V 60 Hz	<b>B</b>
230V 50 Hz	<b>F</b>
24V 50/60 Hz	<b>T</b>
24–27 Vdc	<b>TD</b> <sup>③</sup>
415V 50 Hz, 480V 60 Hz	<b>C</b>
550V 50 Hz, 600V 60 Hz	<b>D</b>
208V 60 Hz	<b>E</b>
190V 50 Hz, 220V 60 Hz	<b>G</b>
240V 50 Hz, 277V 60 Hz	<b>H</b>

Coil Voltage	Suffix Code
380V 50 Hz, 440V 60 Hz	<b>L</b>
400V 50 Hz	<b>N</b>
380V 60 Hz	<b>P</b>
12V 50/60 Hz	<b>R</b>
42V 50 Hz, 48V 60 Hz	<b>W</b>
48V 50 Hz	<b>Y</b>
110–130 Vdc	<b>AD</b> <sup>③</sup>
200–240 Vdc	<b>BD</b> <sup>③</sup>
12–14 Vdc	<b>RD</b> <sup>③</sup>
48–60 Vdc	<b>WD</b> <sup>③</sup>

#### Notes

The assembled manual motor controller (MMC) consists of an XTPR manual motor protector (MMP) and an XTCE contactor. For Frame B MMP + Frame B contactor assemblies, the XTSC and XTSR can be mounted directly on DIN rail without an adapter. The contactors are supported mechanically with a mechanical connection element (included in XTPAXTPCB, XTPAXRPCR). For 16A and above, the assembly is mounted via a DIN rail adapter plate (XTPAXTPCPC, XTPAXTPCPD) and the electrical connection is made with electrical contact modules (XTPAXECMC, XTPAXECMD), both included in XTPAXTPCC and XTPAXTPCD.

Service Factor (SF)—Setting  $I_r$  of current scale in dependence of load factor:

$$SF = 1.15 \rightarrow I_r = 1 \times I_{n \text{ mot}}$$

$$SF = 1 \rightarrow I_r = 0.9 \times I_{n \text{ mot}}$$

Single-phasing sensitivity to IEC/EN 60947-4-1, VDE 0660 Part 102.

- ① Select combination motor controllers by full load amperes. Maximum motor ratings (kW, hp) are for reference only.
- ② Underscore (\_) indicates magnetic coil suffix required. See AC and DC coil suffixes above.
- ③ With DC operation: Integrated diode-resistor combination, coil rating 2.6W.

#### XTFC Manual Motor Controller

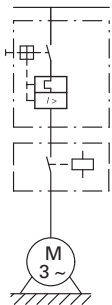

#### XTFR Manual Motor Controller

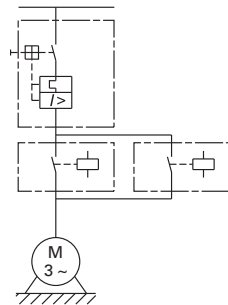



## Accessories

### Line Side Adapters

Line side adapters are required for use with XTPR MMPs only when used as Type E self-protected manual combination starters or as part of XTFC or XTFR Type F combination motor controllers. Not required for group installation.

#### Line Side Adapters

	Description	Catalog Number
<b>XTPAXLSA</b> 	For use with Frame B MMPs (up to 32A)	<b>XTPAXLSA</b>
<b>XTPAXLSAD</b> 	For use with Frame D MMPs (up to 40A)	<b>XTPAXLSAD</b>

### Combination Connection Kits

Combination connection kits include the necessary components to field assemble a manual motor controller with an MMP (XTPR) and contactor (XTCE).

#### Non-Reversing Starters

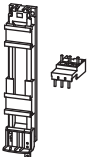
	For Use with ...	Description/Composed of ...	Std. Pack ①	Catalog Number
<b>XTPAXTPCB</b> 	XTPR...B + XTCE...B	Mechanical connection element for XTPR...B and contactor	1	<b>XTPAXTPCB</b>
		Main current wiring between XTPR...B and contactor in toolless plug connection	1	
		Cable guidance	1	
		Use as contactor auxiliary switch XTCEXFAT_-. Control cable guidance: max. six cables up to 2.5 mm <sup>2</sup> external diameter or four cables up to 3.5 mm <sup>2</sup> external diameter		
<b>XTPAXTPCC and XTPAXTPCD</b> 	XTPR...B + XTCE...C	DIN rail adapter plate	1	<b>XTPAXTPCC</b>
	XTPR...D + XTCE...D	Main current wiring between XTPR and contactor	1	<b>XTPAXTPCD</b>

#### Reversing Starters

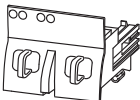
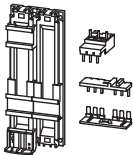
	For Use with ...	Description/Composed of ...	Std. Pack ①	Catalog Number
<b>XTPAXTPCRB</b> 	XTPR...B + XTCE...B01_	Mechanical connection element for XTPR...B and contactor	1	<b>XTPAXTPCRB</b>
		Reversing starter main current wiring in toolless plug connection	1	
		Control cables for electrical interlocking in toolless plug connection— K1M: A1–K2M: 21, K1M: 21–K2M: A1, K1M: A2–K2M: A2	1	
		Cable guidance	1	
		Use as contactor auxiliary switch XTCEXFAT_-. Control cable guidance: max. six cables up to 2.5 mm <sup>2</sup> external diameter or four cables up to 3.5 mm <sup>2</sup> external diameter.		
<b>XTPAXTPCRC</b> 	XTPR...B + XTCE...C	DIN rail adapter plate	1	<b>XTPAXTPCRB</b>
		Reversing starter main current wiring	1	

#### Note

① Orders must be placed in multiples of package quantity listed.

#### XTPAXEC\_

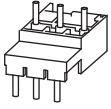

#### Electric Contact Module

For Use with ...	Description/Composed of ...	Std. Pack <sup>①</sup>	Catalog Number
XTPR...B + XTCE...C	Main current wiring between XTPR...B and contactor Use only in combination with busbar adapter	5	<b>XTPAXECMC</b>
XTPR...D + XTCE...D	Main current wiring between XTPR...D and contactor Use only in combination with busbar adapter	5	<b>XTPAXECMD</b>

#### DIN Rail Adapter Plates

##### XTPAXTPCPB

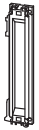

For Use with ...	Description/Composed of ...	Std. Pack <sup>①</sup>	Catalog Number
XTPAXTPCB XTPAXTPCRB	45 mm wide adapter plate with one DIN rail  Connection element for side-by-side positioning of further plates	4	<b>XTPAXTPCPB</b>

##### XTPAXTPCRPB

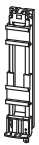

XTPR...B + XTCE...C XTPAXECMC	45 mm wide adapter plate with one DIN rail  Connection element for side-by-side positioning of further plates	4	<b>XTPAXTPCRPB</b>
----------------------------------	---	---	--------------------

##### XTPAXTPCPD



XTPAXECMD XTPR...D + XTCE...C XTPR...D + XTCE...D	55 mm wide adapter plate with two DIN rails  Connection cams for further plates  For use with reversing and star-delta starters	4  4	<b>XTPAXTPCPD</b>
---	---	------------	-------------------

#### Lateral Module

For Use with ...	Description/Composed of ...	Std. Pack <sup>①</sup>	Catalog Number
—	Can be grouped on the DIN rail adapter Expansion of the mounting width by 9 mm	10	<b>XTPAXLM</b>

#### Connection Element

For Use with ...	Description/Composed of ...	Std. Pack <sup>①</sup>	Catalog Number
—	For connection of several DIN rail adapters	50	<b>XTPAXCNE</b>

#### Note

<sup>①</sup> Orders must be placed in multiples of package quantity listed.

## Technical Data and Specifications

### XTSC Non-Reversing Manual Motor Controllers (MMC)—Component Bill of Material

#### Factory Assembled Manual Motor Protector + Contactor

Assembled Manual Motor Controller <sup>①</sup>	FLA Adjustment Range/Overload Release— $I_r$ (Amps)	Component Catalog Numbers		Contactor <sup>①</sup>	Manual Motor Protector Auxiliary Contact
		Manual Motor Protector	Combination Connection Kit		
<b>XTSC Frame B MMP + Frame B Contactor</b>					
XTSCP16BB_	0.1–0.16	XTPRP16BC1	XTPAXTPCB	XTCE007B10_	XTPAXFA11
XTSCP25BB_	0.16–0.25	XTPRP25BC1	XTPAXTPCB	XTCE007B10_	XTPAXFA11
XTSCP40BB_	0.25–0.4	XTPRP40BC1	XTPAXTPCB	XTCE007B10_	XTPAXFA11
XTSCP63BB_	0.4–0.63	XTPRP63BC1	XTPAXTPCB	XTCE007B10_	XTPAXFA11
XTSC001BB_	0.63–1	XTPR001BC1	XTPAXTPCB	XTCE007B10_	XTPAXFA11
XTSC1P6BB_	1–1.6	XTPR1P6BC1	XTPAXTPCB	XTCE007B10_	XTPAXFA11
XTSC2P5BB_	1.6–2.5	XTPR2P5BC1	XTPAXTPCB	XTCE007B10_	XTPAXFA11
XTSC004BB_	2.5–4	XTPR004BC1	XTPAXTPCB	XTCE007B10_	XTPAXFA11
XTSC6P3BB_	4–6.3	XTPR6P3BC1	XTPAXTPCB	XTCE007B10_	XTPAXFA11
XTSC010BB_	6.3–10	XTPR010BC1	XTPAXTPCB	XTCE009B10_	XTPAXFA11
XTSC012BB_	8–12	XTPR012BC1	XTPAXTPCB	XTCE012B10_	XTPAXFA11
XTSC016BB_	10–16	XTPR016BC1	XTPAXTPCB	XTCE015B10_	XTPAXFA11
<b>XTSC Frame B MMP + Frame C Contactor</b>					
XTSC016BC_	10–16	XTPR016BC1	XTPAXTPCC	XTCE018C10_	XTPAXFA1
XTSC020BC_	16–20	XTPR020BC1	XTPAXTPCC	XTCE025C10_	XTPAXFA11
XTSC025BC_	20–25	XTPR025BC1	XTPAXTPCC	XTCE025C10_	XTPAXFA11
XTSC032BC_	25–32	XTPR032BC1	XTPAXTPCC	XTCE032C10_	XTPAXFA11
<b>XTSC Frame D MMP + Frame C Contactor</b>					
XTSC016DC_	10–16	XTPR016DC1	②	XTCE018C10_	XTPAXFA1
XTSC025DC_	16–25	XTPR025DC1	②	XTCE025C10_	XTPAXFA11
XTSC032DC_	25–32	XTPR032DC1	②	XTCE032C10_	XTPAXFA11
<b>XTSC Frame D MMP + Frame D Contactor</b>					
XTSC040DD_	32–40	XTPR040DC1	XTPAXTPCD <sup>③</sup>	XTCE040D00_	XTPAXFA11
XTSC050DD_	40–50	XTPR050DC1	XTPAXTPCD <sup>③</sup>	XTCE050D00_	XTPAXFA11
XTSC058DD_	50–58	XTPR058DC1	XTPAXTPCD <sup>③</sup>	XTCE065D00_	XTPAXFA11
XTSC063DD_	55–65	XTPR063DC1	XTPAXTPCD <sup>③</sup>	XTCE065D00_	XTPAXFA11

#### Notes

① Underscore (\_) indicates magnetic coil suffix required. See **Page V5-T1-202**.

② The connection between the XTPR...DC1 and the XTCE...C\_ contactor will be made with flexible wire and mounted to the DIN rail adapter plate (XTPAXTPCPD).

③ The reversing connection between the XTPR...DC1 and the (2) XTCE...C\_ contactors will be accomplished by using the non-reversing combination connection kit (XTPAXTPCD), Frame D reversing link kit (XTCEXRLD), additional DIN rail adapter plate (XTPAXTPCPD) and DIN adapter connection element (XTPAXCNE).

## XTSR Reversing Manual Motor Controllers (MMC)—Component Bill of Material

## Factory Assembled Manual Motor Protector + Contactor

Assembled Manual Motor Controller <sup>①</sup>	FLA Adjustment Range/Overload Release—I <sub>r</sub> (Amps)	Component Catalog Numbers		Contactor <sup>①</sup>	Manual Motor Protector Auxiliary Contact
		Manual Motor Protector	Combination Connection Kit		
<b>XTSR Frame B MMP + Frame B Contactor</b>					
XTSRP16BB_	0.1–0.16	XTPRP16BC1	XTPAXTPCRB	(2) XTCE007B01_	XTPAXFA11
XTSRP25BB_	0.16–0.25	XTPRP25BC1	XTPAXTPCRB	(2) XTCE007B01_	XTPAXFA11
XTSRP40BB_	0.25–0.4	XTPRP40BC1	XTPAXTPCRB	(2) XTCE007B01_	XTPAXFA11
XTSRP63BB_	0.4–0.63	XTPRP63BC1	XTPAXTPCRB	(2) XTCE007B01_	XTPAXFA11
XTSR001BB_	0.63–1	XTPR001BC1	XTPAXTPCRB	(2) XTCE007B01_	XTPAXFA11
XTSR1P6BB_	1–1.6	XTPR1P6BC1	XTPAXTPCRB	(2) XTCE007B01_	XTPAXFA11
XTSR2P5BB_	1.6–2.5	XTPR2P5BC1	XTPAXTPCRB	(2) XTCE007B01_	XTPAXFA11
XTSR004BB_	2.5–4	XTPR004BC1	XTPAXTPCRB	(2) XTCE007B01_	XTPAXFA11
XTSR6P3BB_	4–6.3	XTPR6P3BC1	XTPAXTPCRB	(2) XTCE007B01_	XTPAXFA11
XTSR010BB_	6.3–10	XTPR010BC1	XTPAXTPCRB	(2) XTCE009B01_	XTPAXFA11
XTSR012BB_	8–12	XTPR012BC1	XTPAXTPCRB	(2) XTCE012B01_	XTPAXFA11
<b>XTSR Frame B MMP + Frame C Contactor</b>					
XTSR016BC_	10–16	XTPR016BC1	XTPAXTPCRC	(2) XTCE018C01	XTPAXFA11
XTSR020BC_	16–20	XTPR020BC1	XTPAXTPCRC	(2) XTCE025C01_	XTPAXFA11
XTSR025BC_	20–25	XTPR025BC1	XTPAXTPCRC	(2) XTCE025C01_	XTPAXFA11
XTSR032BC_	25–32	XTPR032BC1	XTPAXTPCRC	(2) XTCE032C01_	XTPAXFA11
<b>XTSR Frame D MMP + Frame C Contactor</b>					
XTSR016DC_	10–16	XTPR016DC1	②	(2) XTCE018C01	XTPAXFA11
XTSR025DC_	16–25	XTPR025DC1	②	(2) XTCE025C01_	XTPAXFA11
XTSR032DC_	25–32	XTPR032DC1	②	(2) XTCE032C01_	XTPAXFA11
<b>XTSR Frame D MMP + Frame D Contactor</b>					
XTSR040DD_	32–40	XTPR040DC1	③	(2) XTCE040D00_	XTPAXFA11
XTSR050DD_	40–50	XTPR050DC1	③	(2) XTCE050D00_	XTPAXFA11
XTSR058DD_	50–58	XTPR058DC1	③	(2) XTCE065D00_	XTPAXFA11
XTSR063DD_	55–65	XTPR063DC1	③	(2) XTCE065D00_	XTPAXFA11

**Notes**

- ① Underscore (\_) indicates magnetic coil suffix required. See **Page V5-T1-202**.
- ② The connection between the XTPR...DC1 and the XTCE...C\_ contactor will be made with flexible wire and mounted to the DIN rail adapter plate (XTPAXTPCPD).
- ③ The reversing connection between the XTPR...DC1 and the (2) XTCE...C\_ contactors will be accomplished by using the non-reversing combination connection kit (XTPAXTPCD), Frame D reversing link kit (XTCEXRLD), additional DIN rail adapter plate (XTPAXTPCPD) and DIN adapter connection element (XTPAXCNE).

## XTFC Non-Reversing Combination Motor Controllers—Component Bill of Material

### Factory Assembled Manual Motor Protector + Contactor + Line Side Adapter

Assembled Combination Motor Controller <sup>①</sup>	FLA Adjustment Range/ Overload Release— $I_r$ (Amps)	Component Catalog Numbers			Manual Motor Protector	Combination Connection Kit	Contactor <sup>①</sup>	Manual Motor Protector Auxiliary Contact
		Line Side Adapter	Manual Motor Protector	Combination Connection Kit				
<b>XTFC Frame B MMP + Frame B Contactor</b>								
XTFCP16BB_	0.1–0.16	XTPAXLSA	XTPRP16BC1	XTPAXTPCB	XTCE007B10_	XTPAXFA11		
XTFCP25BB_	0.16–0.25	XTPAXLSA	XTPRP25BC1	XTPAXTPCB	XTCE007B10_	XTPAXFA11		
XTFCP40BB_	0.25–0.4	XTPAXLSA	XTPRP40BC1	XTPAXTPCB	XTCE007B10_	XTPAXFA11		
XTFCP63BB_	0.4–0.63	XTPAXLSA	XTPRP63BC1	XTPAXTPCB	XTCE007B10_	XTPAXFA11		
XTFC001BB_	0.63–1	XTPAXLS	XTPR001BC1	XTPAXTPCB	XTCE007B10_	XTPAXFA11		
XTFC1P6BB_	1–1.6	XTPAXLSA	XTPR1P6BC1	XTPAXTPCB	XTCE007B10_	XTPAXFA11		
XTFC2P5BB_	1.6–2.5	XTPAXLSA	XTPR2P5BC1	XTPAXTPCB	XTCE007B10_	XTPAXFA11		
XTFC004BB_	2.5–4	XTPAXLSA	XTPR004BC1	XTPAXTPCB	XTCE007B10_	XTPAXFA11		
XTFC6P3BB_	4–6.3	XTPAXLSA	XTPR6P3BC1	XTPAXTPCB	XTCE007B10_	XTPAXFA11		
XTFC010BB_	6.3–10	XTPAXLSA	XTPR010BC1	XTPAXTPCB	XTCE009B10_	XTPAXFA11		
XTFC012BB_	8–12	XTPAXLSA	XTPR012BC1	XTPAXTPCB	XTCE012B10_	XTPAXFA11		
XTFC016BB_	10–16	XTPAXLSA	XTPR016BC1	XTPAXTPCB	XTCE015B10_	XTPAXFA11		
<b>XTFC Frame B MMP + Frame C Contactor</b>								
XTFC016BC_	10–16	XTPAXLSA	XTPR016BC1	XTPAXTPCC	XTCE018C10_	XTPAXFA11		
XTFC020BC_	16–20	XTPAXLSA	XTPR020BC1	XTPAXTPCC	XTCE025C10_	XTPAXFA11		
XTFC025BC_	20–25	XTPAXLSA	XTPR025BC1	XTPAXTPCC	XTCE025C10_	XTPAXFA11		
XTFC032BC_	25–32	XTPAXLSA	XTPR032BC1	XTPAXTPCC	XTCE032C10_	XTPAXFA11		
<b>XTFC Frame D MMP + Frame C Contactor</b>								
XTFC016DC_	10–16	XTPAXLSAD	XTPR016DC1	②	XTCE018C10_	XTPAXFA11		
XTFC025DC_	16–25	XTPAXLSAD	XTPR025DC1	②	XTCE025C10_	XTPAXFA11		
XTFC032DC_	25–32	XTPAXLSAD	XTPR032DC1	②	XTCE032C10_	XTPAXFA11		
<b>XTFC Frame D MMP + Frame D Contactor</b>								
XTFC040DD_	32–40	XTPAXLSAD	XTPR040DC1	XTPAXTPCD <sup>③</sup>	XTCE040D00_	XTPAXFA11		
XTFC050DD_	40–50	XTPAXLSAD	XTPR050DC1	XTPAXTPCD <sup>③</sup>	XTCE050D00_	XTPAXFA11		
XTFC058DD_	50–58	XTPAXLSAD	XTPR058DC1	XTPAXTPCD <sup>③</sup>	XTCE065D00_	XTPAXFA11		
XTFC063DD_	55–65	XTPAXLSAD	XTPR063DC1	XTPAXTPCD <sup>③</sup>	XTCE065D00_	XTPAXFA11		

#### Notes

① Underscore (\_) indicates magnetic coil suffix required. See **Page V5-T1-202**.

② The connection between the XTPR...DC1 and the XTCE...C\_ contactor will be made with flexible wire and mounted to the DIN rail adapter plate (XTPAXTPCPD).

③ The reversing connection between the XTPR...DC1 and the (2) XTCE...C\_ contactors will be accomplished by using the non-reversing combination connection kit (XTPAXTPCD), Frame D reversing link kit (XTCEXRDL), additional DIN rail adapter plate (XTPAXTPCPD) and DIN adapter connection element (XTPAXCNE).

## XTFR Reversing Combination Motor Controllers—Component Bill of Material

### Factory Assembled Manual Motor Protector + Contactor + Line Side Adapter

Assembled Combination Motor Controller <sup>①</sup>	FLA Adjustment Range/ Overload Release— $I_r$ (Amps)	Component Catalog Numbers			Manual Motor Protector	Combination Connection Kit	Contactor <sup>①</sup>	Manual Motor Protector Auxiliary Contact
		Line Side Adapter	Manual Motor Protector	Combination Connection Kit				
<b>XTFR Frame B MMP + Frame B Contactor</b>								
XTFRP16BB_	0.1–0.16	XTPAXLSA	XTPRP16BC1	XTPAXTPCRB	(2) XTCE007B01_	XTPAXFA11		
XTFRP25BB_	0.16–0.25	XTPAXLSA	XTPRP25BC1	XTPAXTPCRB	(2) XTCE007B01_	XTPAXFA11		
XTFRP40BB_	0.25–0.4	XTPAXLSA	XTPRP40BC1	XTPAXTPCRB	(2) XTCE007B01_	XTPAXFA11		
XTFRP63BB_	0.4–0.63	XTPAXLSA	XTPRP63BC1	XTPAXTPCRB	(2) XTCE007B01_	XTPAXFA11		
XTFR001BB_	0.63–1	XTPAXLSA	XTPR001BC1	XTPAXTPCRB	(2) XTCE007B01_	XTPAXFA11		
XTFR1P6BB_	1–1.6	XTPAXLSA	XTPR1P6BC1	XTPAXTPCRB	(2) XTCE007B01_	XTPAXFA11		
XTFR2P5BB_	1.6–2.5	XTPAXLSA	XTPR2P5BC1	XTPAXTPCRB	(2) XTCE007B01_	XTPAXFA11		
XTFR004BB_	2.5–4	XTPAXLSA	XTPR004BC1	XTPAXTPCRB	(2) XTCE007B01_	XTPAXFA11		
XTFR6P3BB_	4–6.3	XTPAXLSA	XTPR6P3BC1	XTPAXTPCRB	(2) XTCE007B01_	XTPAXFA11		
XTFR010BB_	6.3–10	XTPAXLSA	XTPR010BC	XTPAXTPCRB	(2) XTCE009B01_	XTPAXFA11		
XTFR012BB_	8–12	XTPAXLSA	XTPR012BC1	XTPAXTPCRB	(2) XTCE012B01_	XTPAXFA11		
<b>XTFR Frame B MMP + Frame C Contactor</b>								
XTFR016BC_	10–16	XTPAXLSA	XTPR016BC1	XTPAXTPCRC	(2) XTCE018C01_	XTPAXFA11		
XTFR020BC_	16–20	XTPAXLSA	XTPR020BC1	XTPAXTPCRC	(2) XTCE025C01_	XTPAXFA11		
XTFR025BC_	20–25	XTPAXLSA	XTPR025BC1	XTPAXTPCRC	(2) XTCE025C01_	XTPAXFA11		
XTFR032BC_	25–32	XTPAXLSA	XTPR032BC1	XTPAXTPCRC	(2) XTCE032C01_	XTPAXFA11		
<b>XTFR Frame D MMP + Frame C Contactor</b>								
XTFR016DC_	10–16	XTPAXLSAD	XTPR016DC1	②	(2) XTCE018C01_	XTPAXFA11		
XTFR025DC_	16–25	XTPAXLSAD	XTPR025DC1	②	(2) XTCE025C01_	XTPAXFA11		
XTFR032DC_	25–32	XTPAXLSAD	XTPR032DC1	②	(2) XTCE032C01_	XTPAXFA11		
<b>XTFR Frame D MMP + Frame D Contactor</b>								
XTFR040DD_	32–40	XTPAXLSAD	XTPR040DC1	③	(2) XTCE040D00_	XTPAXFA11		
XTFR050DD_	40–50	XTPAXLSAD	XTPR050DC1	③	(2) XTCE050D00_	XTPAXFA11		
XTFR058DD_	50–58	XTPAXLSAD	XTPR058DC1	③	(2) XTCE065D00_	XTPAXFA11		
XTFR063DD_	55–65	XTPAXLSAD	XTPR063DC1	③	(2) XTCE065D00_	XTPAXFA11		

#### Notes

① Underscore (\_) indicates magnetic coil suffix required. See **Page V5-T1-202**.

② The connection between the XTPR...DC1 and the XTCE...C\_ contactor will be made with flexible wire and mounted to the DIN rail adapter plate (XTPAXTPCPD).

③ The reversing connection between the XTPR...DC1 and the (2) XTCE...C\_ contactors will be accomplished by using the non-reversing combination connection kit (XTPAXTPCD), Frame D reversing link kit (XTCEXRLD), additional DIN rail adapter plate (XTPAXTPCPD) and DIN adapter connection element (XTPAXCNE).



## Manual Motor Controllers Short-Circuit Ratings for UL/CSA Group Installations

## XTSC and XTSR Manual Motor Controllers (MMC)

Assembled Controller <sup>①</sup>		FLA Adjustment Range/Overload Release— I <sub>r</sub> (Amps)	Short-Circuit Release— I <sub>rm</sub> (Amps)	Group Installation, UL/CSA Max. rms Symmetrical Short-Circuit Ratings (kA/kA with Current Limiter)			Maximum Upstream Protective Device (A/A with Current Limiter)	
				240V	480V	600V	Maximum Fuse 600V	Maximum Circuit Breaker 600V
Non-Reversing	Reversing							
<b>XTSC and XTSR Frame B MMP + Frame B Contactor</b>								
XTSCP16BB_	XTSRP16BB_	0.1–0.16	2.2	50	50	50	600	600
XTSCP25BB_	XTSRP25BB_	0.16–0.25	3.5	50	50	50	600	600
XTSCP40BB_	XTSRP40BB_	0.25–0.4	5.6	50	50	50	600	600
XTSCP63BB_	XTSRP63BB_	0.4–0.63	8.82	50	50	50	600	600
XTSC001BB_	XTSR001BB_	0.63–1	14	50	50	50	600	600
XTSC1P6BB_	XTSR1P6BB_	1–1.6	22.4	50	50	50	600	600
XTSC2P5BB_	XTSR2P5BB_	1.6–2.5	35	50	50	50	600	600
XTSC004BB_	XTSR004BB_	2.5–4	56	50	50	50	600	600
XTSC6P3BB_	XTSR6P3BB_	4–6.3	88.2	50	50	50	600	600
XTSC010BB_	XTSR010BB_	6.3–10	140	22	22	22	150/600	125/600
XTSC012BB_	XTSR012BB_	8–12	168	10/50	10/50	10/50	150/600	125/600
XTSC016BB_	—	10–16	224	10/50	10/50	10/50	150/600	125/600
<b>XTSC and XTSR Frame B MMP + Frame C Contactor</b>								
XTSC016BC_	XTSR016BC_	10–16	224	10/50	10/50	10/50	150/600	125/600
XTSC020BC_	XTSR020BC_	16–20	280	10/18	10/18	10/18	150/600	125/600
XTSC025BC_	XTSR025BC_	20–25	350	10/18	10/18	10/18	150/600	125/600
XTSC032BC_	XTSR032BC_	25–32	448	5/18	5/18	5/18	150/600	125/600
<b>XTSC and XTSR Frame D MMP + Frame C Contactor</b>								
XTSC016DC_	XTSR016DC_	10–16	224	50	50	10	600	600
XTSC025DC_	XTSR025DC_	16–25	350	50	50	10	600	600
XTSC032DC_	XTSR032DC_	25–32	448	50	50	10	600	600
<b>XTSC and XTSR Frame D MMP + Frame D Contactor</b>								
XTSC040DD_	XTSR040DD_	32–40	560	50	50	10	600	600
XTSC050DD_	XTSR050DD_	40–50	700	50	50	10	600	600
XTSC058DD	XTSR058DD	50–58	812	50	50	—	—	—
XTSC063DD_	XTSR063DD_	55–65	882	50	50	—	—	—

**Note**

① Underscore ( \_ ) indicates magnetic coil suffix required. See Page V5-T1-202.

## Combination Motor Controllers Short-Circuit Ratings for UL 508 Type F Application

## XTFC and XTFR Combination Motor Controllers (CMC), UL 508 Type F

Assembled Controller <sup>①</sup>		FLA Adjustment Range/Overload Release— I <sub>r</sub> (Amps)	Short-Circuit Release— I <sub>rm</sub> (Amps)	UL 508 Type F Application Max. rms Symmetrical Short-Circuit Ratings (kA)			Maximum Upstream Protective Device (A) <sup>②</sup>	
				240V	480/277V	600/347V	Maximum Fuse 600V	Maximum Circuit Breaker 600V
Non-Reversing	Reversing							
<b>XTFC and XTFR Frame B MMP + Frame B Contactor</b>								
XTFCP16BB_	XTFRP16BB_	0.1–0.16	2.2	65	65	—	Not required	Not required
XTFCP25BB_	XTFRP25BB_	0.16–0.25	3.5	65	65	—	Not required	Not required
XTFCP40BB_	XTFRP40BB_	0.25–0.4	5.6	65	65	—	Not required	Not required
XTFCP63BB_	XTFRP63BB_	0.4–0.63	8.82	65	65	—	Not required	Not required
XTFC001BB_	XTFR001BB_	0.63–1	14	65	65	—	Not required	Not required
XTFC1P6BB_	XTFR1P6BB_	1–1.6	22.4	65	65	—	Not required	Not required
XTFC2P5BB_	XTFR2P5BB_	1.6–2.5	35	65	65	—	Not required	Not required
XTFC004BB_	XTFR004BB_	2.5–4	56	65	65	—	Not required	Not required
XTFC6P3BB_	XTFR6P3BB_	4–6.3	88.2	65	65	—	Not required	Not required
XTFC010BB_	XTFR010BB_	6.3–10	140	65	65	—	Not required	Not required
XTFC012BB_	XTFR012BB_	8–12	168	50	50	—	Not required	Not required
XTFC016BB_	—	10–16	224	50	50	—	Not required	Not required
<b>XTFC and XTFR Frame B MMP + Frame C Contactor</b>								
XTFC016BC_	XTFR016BC_	10–16	224	18	18	—	Not required	Not required
XTFC020BC_	XTFR020BC_	16–20	280	18	18	—	Not required	Not required
XTFC025BC_	XTFR025BC_	20–25	350	18	18	—	Not required	Not required
XTFC032BC_	XTFR032BC_	25–32	448	18	18	—	Not required	Not required
<b>XTFC and XTFR Frame D MMP + Frame C Contactor</b>								
XTFC016DC_	XTFR016DC_	10–16	224	65	65	50	Not required	Not required
XTFC025DC_	XTFR025DC_	16–25	350	65	65	50	Not required	Not required
XTFC032DC_	XTFR032DC_	25–32	448	65	65	50	Not required	Not required
<b>XTFC and XTFR Frame D MMP + Frame D Contactor</b>								
XTFC040DD_	XTFR040DD_	32–40	560	65	65	50	Not required	Not required
XTFC050DD_	XTFR050DD_	40–50	700	65	65	—	Not required	Not required
XTFC058DD_	XTFR058DD_	50–58	812	65	65	—	Not required	Not required
XTFC063DD_	XTFR063DD_	55–65	882	65	65	—	Not required	Not required

**Notes**

① Underscore ( \_ ) indicates magnetic coil suffix required. See **Page V5-T1-202**.

② For UL 508 Type F applications, the combination motor controller assembly does not require a dedicated upstream protective device in the panel, thus a maximum rating is not required.

**Dimensions**

Approximate Dimensions in mm [in]

**XTSC...BB\_**

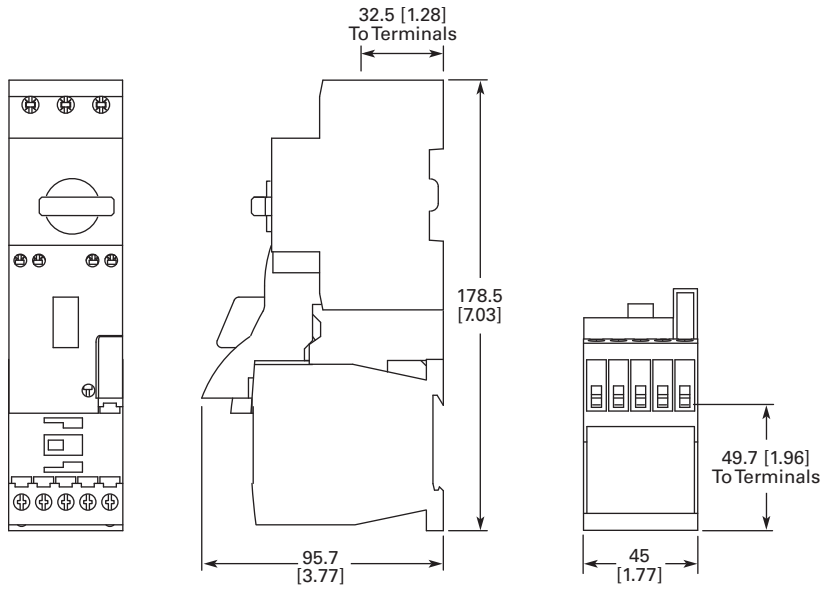

**XTSR...BB\_**

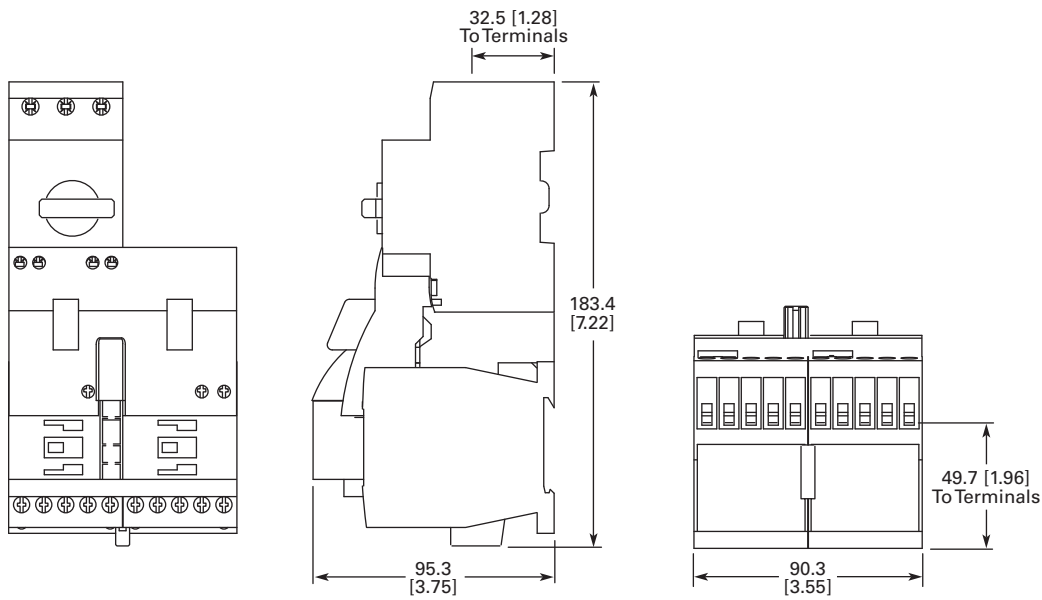

# 1.1

## IEC Contactors and Starters

### XT IEC Power Control

1

Approximate Dimensions in mm [in]

#### XTSC...BC\_

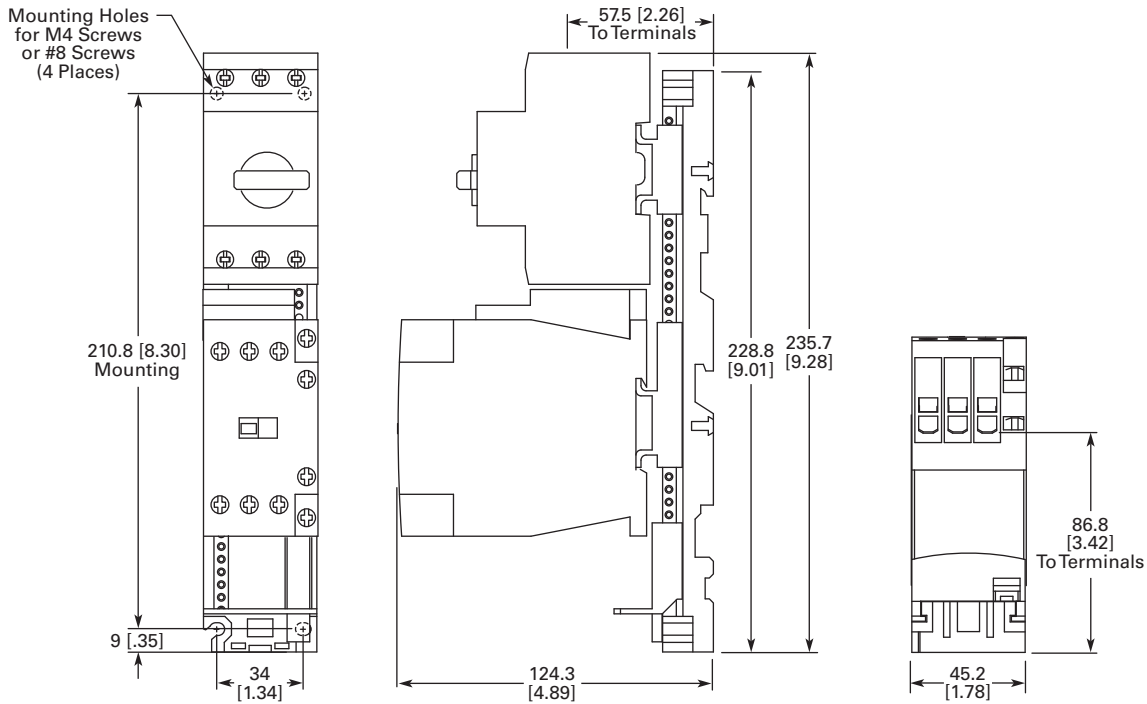

#### XTSR...BC\_

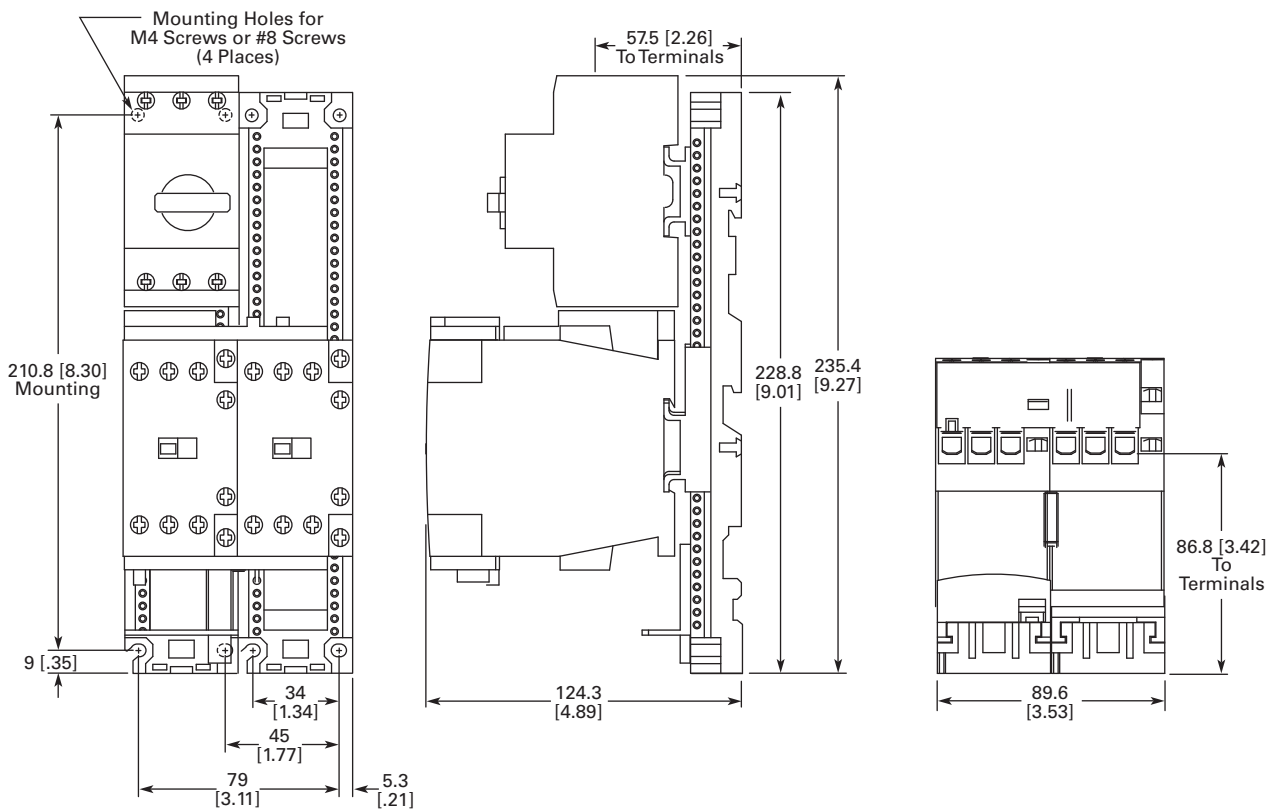

Approximate Dimensions in mm [in]

**XTSC...DD\_**

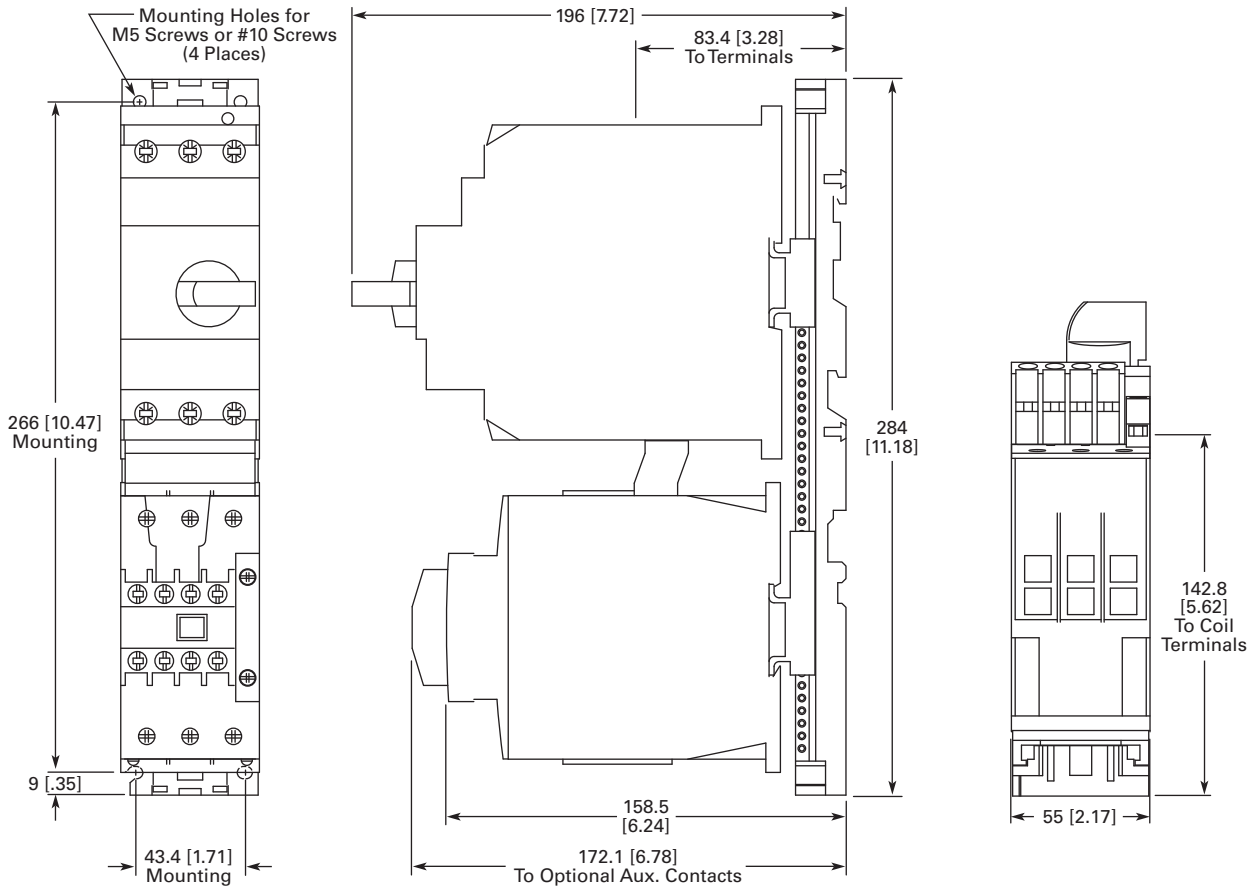

**XTFC...BB\_**

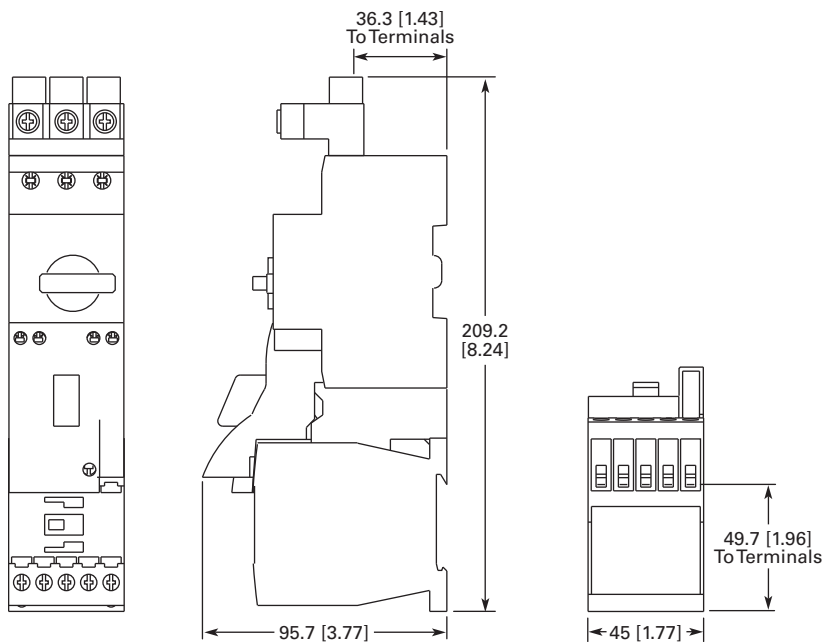

# 1.1

## IEC Contactors and Starters

### XT IEC Power Control

1

Approximate Dimensions in mm [in]

#### XTFR...BB\_

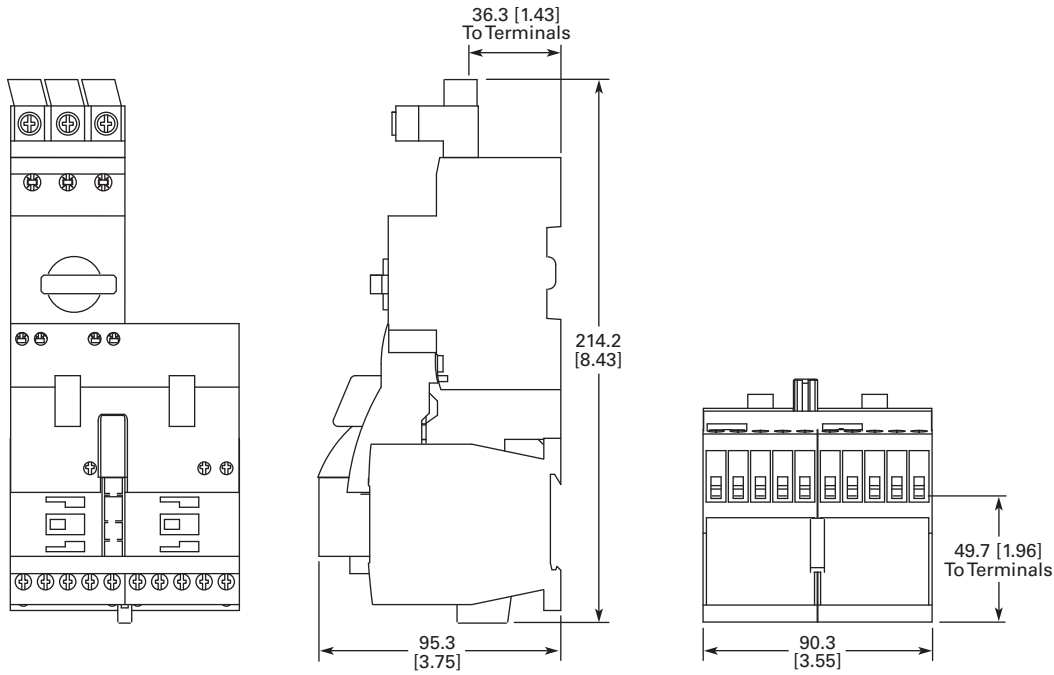

#### XTFC...BC\_

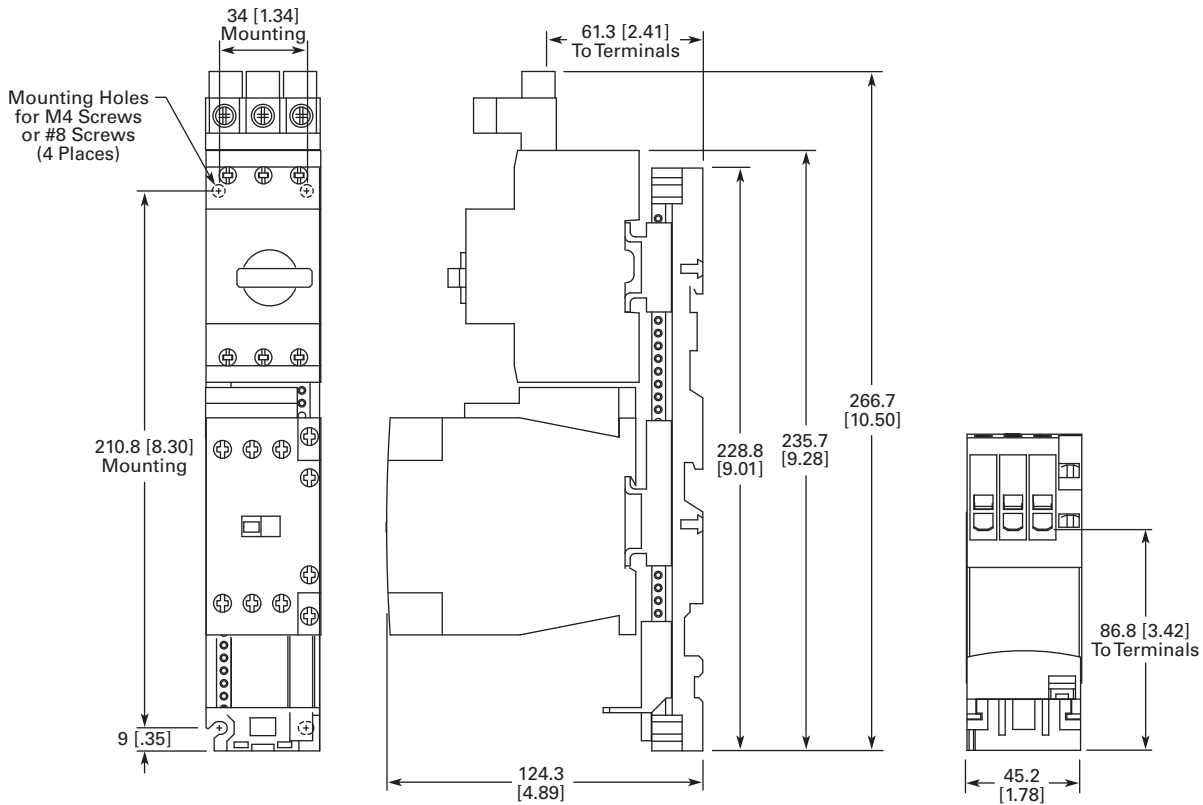

Approximate Dimensions in mm [in]

**XTFR...BC\_**

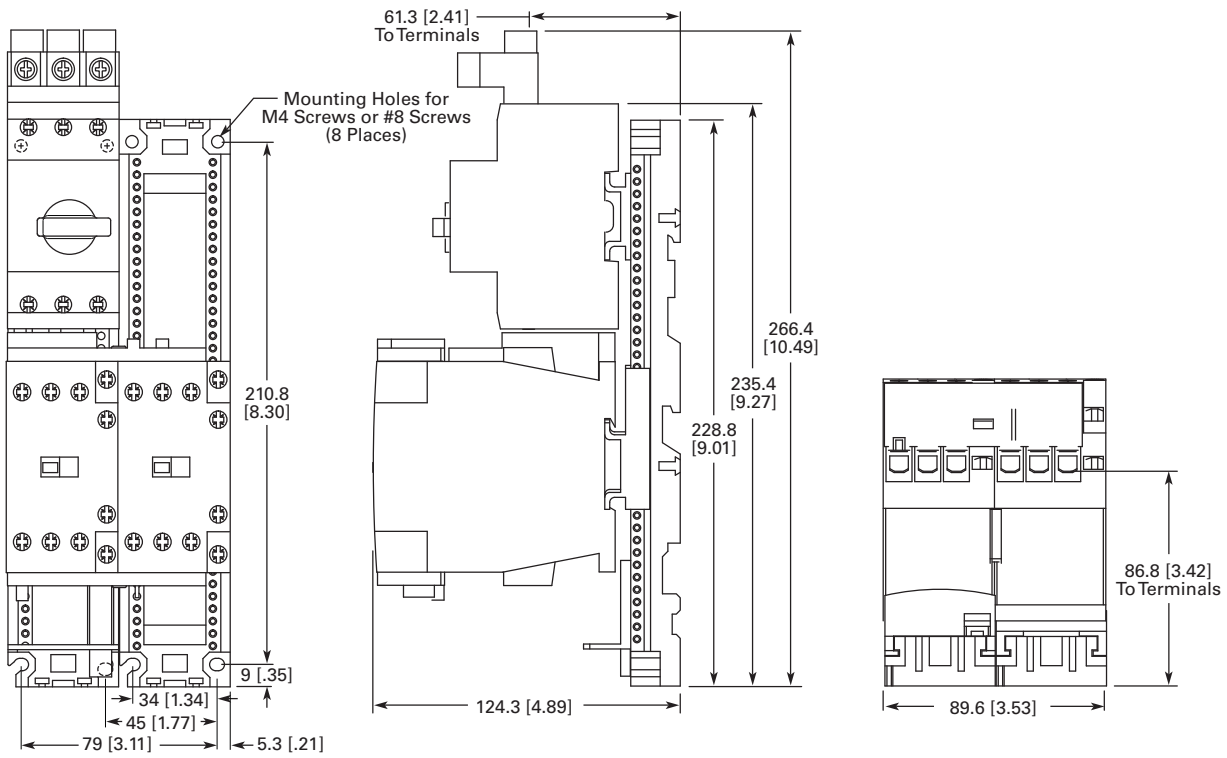

**XTFC...DD\_**

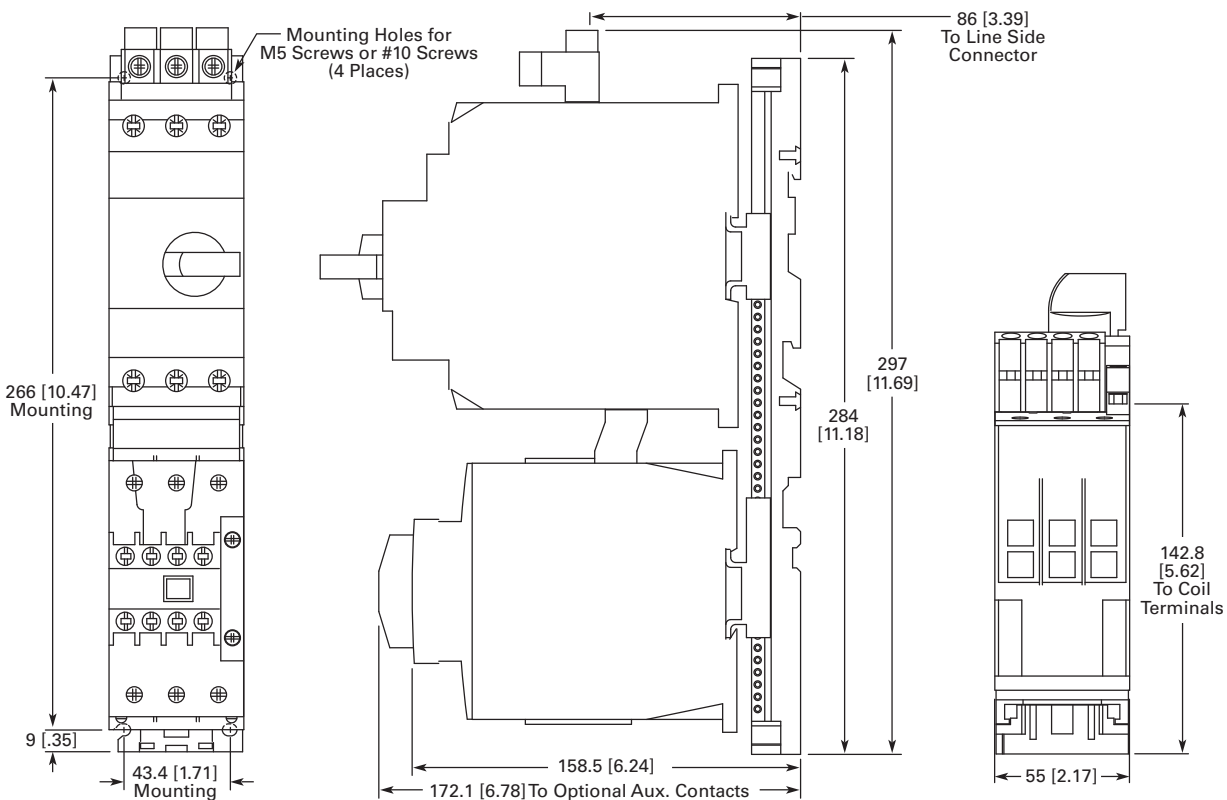

#### XT Electronic Manual Motor Protector



### XT Electronic Manual Motor Protector

#### Product Description

The **XT** Electronic Manual Motor Protector provides the same functionality as the **XT** thermal manual motor protector, but with an added level of flexibility and selectability. The XTPE incorporates electronic control technology to enable more options and larger dial setting ranges. The trip units are interchangeable, allowing users to exchange as needed using the same base. The reduced number of part numbers decreases bill of material complexity while reducing inventory demands. The XTPE electronic manual motor protector includes the following features:

- 4:1 max to min overcurrent dial setting range
- Selectable trip class (5, 10, 15, 20)
- Interchangeable trip units
- Three base units (12, 32 and 65A)
- Common accessories with the XTPR

#### Features and Benefits

##### Advanced Trip Unit



In addition to the selectability, the XTPE is also available with an advanced trip unit that can communicate system data and protector data thru SmartWire-DT. SmartWire-DT is an innovative cost effective connection technology that enables quick installation of control wiring to the starter through a single green cable. When on SmartWire-DT, the XTPE can communicate the following:

- Current Values
  - Maximum phase current
  - Overload warning

### Contents

#### Description

	<i>Page</i>
Relays and Timers .....	<b>V5-T1-3</b>
Miniature Controls .....	<b>V5-T1-18</b>
Contactors and Starters .....	<b>V5-T1-35</b>
Thermal Overload Relays .....	<b>V5-T1-128</b>
C440/ <b>XT</b> Electronic Overload Relay .....	<b>V5-T1-141</b>
Manual Motor Protectors .....	<b>V5-T1-157</b>
Combination Motor Controllers .....	<b>V5-T1-193</b>
<b>XT</b> Electronic Manual Motor Protector	
Catalog Number Selection .....	<b>V5-T1-217</b>
Product Selection .....	<b>V5-T1-218</b>
Accessories .....	<b>V5-T1-220</b>
Technical Data and Specifications .....	<b>V5-T1-226</b>
Dimensions .....	<b>V5-T1-228</b>
Reference Data .....	<b>V5-T1-229</b>

#### Standards and Certifications

- CE approved
- UL Listed File No. E36332
- UL 508 group motor and Type E
- IEC/EN 60947
- CSA File 012528, Class 3211-05



- Diagnostics Data
  - Overload fault
  - Cause of trip (overcurrent or short circuit)
  - Phase loss
  - Trip via TEST
- Status Messages
  - Control unit type
  - Overload setting
  - Time-lag
  - Switching status

#### XTPE Electronic MMP



The XTPE Electronic MMP provides the selectability, control, and insight options that give panel builders and OEMs the solutions necessary to enhance motor control designs while reducing total costs.



**Catalog Number Selection**

**XT—Manual Motor Protector**

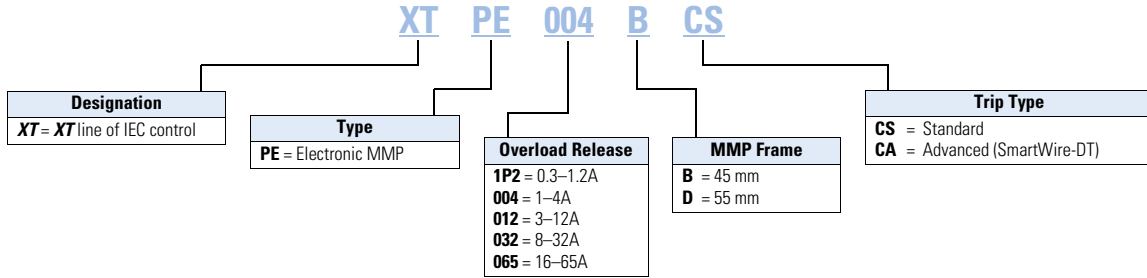

**XT—Combinations**

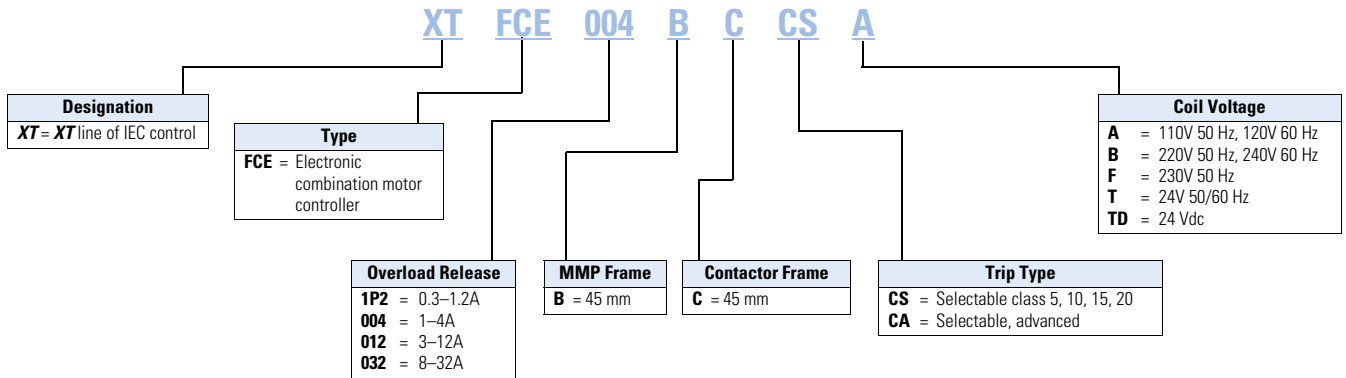

## Product Selection

### XT Electronic Manual Motor Protector

#### B Frame



#### MMP Base

Maximum Amperage	UL/CSA Maximum Three-Phase hp Ratings				IEC Maximum Motor kW Ratings						Base Unit	
	200V	240V	480V	600V	220V 230V 240V	380V 400V 415V	440V	500V	600V 690V	Type Number	Catalog Number	
	12	3	3	7.5	10	3	5.5	5.5	5.5	7.5	PKE12	<b>XTPE012B</b>
32	5	7.5	15	20	7.5	15	15	18.5	30	PKE32	<b>XTPE032B</b>	
65	15	15	40	40	18.5	30	37	45	55	PKE65	<b>XTPE065D</b>	

#### B Frame



#### MMP Trip Units

Overload Release Setting Amp Range	For Use with Base Catalog Number	UL/CSA Maximum Three-Phase hp Ratings				IEC Maximum Motor kW Ratings					Trip Unit	
		200V	240V	480V	600V	220V 230V 240V	380V 400V 415V	440V	500V	600V 690V	Type Number	Catalog Number
		0.3–1.2	XTPE012B	①	①	0.5	0.5	0.18	0.37	0.37	0.37	0.75
1–4	XTPE012B	0.75	0.75	2	3	0.75	1.5	1.5	2.2	3	PKE-XTU-4	<b>XTPEXT004B</b>
3–12	XTPE012B XTPE032B	3	3	7.5	10	3	5.5	5.5	5.5	7.5	PKE-XTU-12	<b>XTPEXT012B</b>
8–32	XTPE032B	5	7.5	15	20	7.5	15	15	18.5	30	PKE-XTU-32	<b>XTPEXT032B</b>
8–32	XTPE065D	7.5	7.5	20	25	7.5	15	15	18.5	30	PKE-XTUW-32	<b>XTPEXT032D</b>
16–65	XTPE065D	15	15	40	40	18.5	30	37	45	55	PKE-XTU-65	<b>XTPEXT065D</b>

#### B Frame



#### MMP Advanced Trip Units Used with SmartWire-DT

Overload Release Setting Amp Range	For Use with Base Catalog Number	UL/CSA Maximum Three-Phase hp Ratings				IEC Maximum Motor kW Ratings					Trip Unit	
		200V	240V	480V	600V	220V 230V 240V	380V 400V 415V	440V	500V	600V 690V	Type Number	Catalog Number
		0.3–1.2	XTPE012B	①	①	0.5	0.5	0.18	0.37	0.37	0.37	0.75
1–4	XTPE012B	0.75	0.75	2	3	0.75	1.5	1.5	2.2	3	PKE-XTUA-4	<b>XTPEXTA004B</b>
3–12	XTPE012B XTPE032B	3	3	7.5	10	3	5.5	5.5	5.5	7.5	PKE-XTUA-12	<b>XTPEXTA012B</b>
8–32	XTPE032B	5	7.5	15	20	7.5	15	15	18.5	30	PKE-XTUA-32	<b>XTPEXTA032B</b>
8–32	XTPE065D	7.5	7.5	20	25	7.5	15	15	18.5	30	PKE-XTUWA-32	<b>XTPEXTA032D</b>
16–65	XTPE065D	15	15	40	40	18.5	30	37	45	55	PKE-XTUA-65	<b>XTPEXTA065D</b>

#### D Frame



#### MMP Complete Assembly

Overload Release Setting Amp Range	UL/CSA Maximum Three-Phase hp Ratings				IEC Maximum Motor kW Ratings					Complete Manual Motor Protector	
	200V	240V	480V	600V	220V 230V 240V	380V 400V 415V	440V	500V	600V 690V	Type Number	Catalog Number
	0.3–1.2	①	①	0.5	0.5	0.18	0.37	0.37	0.37	0.75	PKE12/XTU-1,2
1–4	0.75	0.75	2	3	0.75	1.5	1.5	2.2	3	PKE12/XTU-4	<b>XTPE004BCS</b>
3–12	3	3	7.5	10	3	5.5	5.5	5.5	7.5	PKE12/XTU-12	<b>XTPE012BCS</b>
8–32	5	7.5	15	20	7.5	15	15	18.5	30	PKE32/XTU-32	<b>XTPE032BCS</b>
8–32	7.5	7.5	20	25	7.5	15	15	18.5	30	PKE65/XTUW-32	<b>XTPE032DCS</b>
16–65	15	15	40	40	18.5	30	37	45	55	PKE65/XTU-65	<b>XTPE065DCS</b>

#### Note

① In this range, calculate motor rating according to rated current. Specified values to NEC 430.6 (A) (1).

## B Frame

## MMP Used with SmartWire-DT—Complete Assembly



Overload Release Setting Amp Range	UL/CSA Maximum Motor hp Ratings				IEC Maximum Motor kW Ratings					Complete Manual Motor Protector	
	200V	230V	460V	575V	220V 230V 240V	380V 400V 415V	440V	500V	600V 690V	Type Number	Catalog Number
	0.3–1.2	①	①	0.5	0.5	0.18	0.37	0.37	0.37	0.75	PKE12/XTUA-1,2
1–4	0.75	0.75	2	3	0.75	1.5	1.5	2.2	3	PKE12/XTUA-4	XTPE04BCA
3–12	3	3	7.5	10	3	5.5	5.5	5.5	7.5	PKE12/XTUA-12	XTPE012BCA
8–32	5	7.5	15	20	7.5	15	15	18.5	30	PKE32/XTUA-32	XTPE032BCA

## UL 508 Type E XT Electronic Combination Motor Controllers—Complete Assembly Including Trip Unit

## B Frame

## B Frame Electronic MMP with C Frame Contactor



Overload Release Setting Amp Range	UL/CSA Maximum Three-Phase hp Ratings					Maximum Single-Phase hp Ratings			Catalog Number Standard	Catalog Number With SmartWire-DT
	200V	240V	380V/ 415V	480V/ 277V	600V/ 347V	115V	200V	240V		
0.3–1.2	①	①	①	①	0.5	①	①	①	XTFCE1P2BCCS_③	XTFCE1P2BCCATD ③
1–4	0.75	0.75	1.5	2	—	0.125	0.25	0.33	XTFCE04BCCS_④	XTFCE04BCCATD ④
3–12	3	3	5	7.5	—	0.5	1	1.5	XTFCE012BCCS_④	XTFCE012BCCATD ④
8–32	5	5	10	15	—	1.5	3	3	XTFCE032BCCS_④	XTFCE032BCCATD ④

## Notes

- ① In this range, calculate motor rating according to rated current. Specified values to NEC 430.6 (A) (1).
- ② Complete the catalog number by replacing the underscore (\_) with the coil suffix from **Page V5-T1-238**.
- ③ SCCR: 14 kA, 600 Vac
- ④ SCCR: 18 kA, 480 Vac

## Accessories

### Auxiliary Contacts

#### XTPAXSA\_



#### Side-Mount Auxiliary Contacts

Contact Configuration	Contact Sequence	Pkg. Qty. ①	Screw Terminal Catalog Number
1NO-1NC		5	XTPAXSA11
1NO-2NC		5	XTPAXSA12
2NO-1NC		5	XTPAXSA21

Can be fitted on the right side of manual motor protectors (XTPB, XTPR, XTPM) and manual transformer protectors (XTPT) and can be combined with XTPAXSATR\_ and XTPAXFA\_ trip indicating auxiliary contact.

#### XTPAXFA11



#### Front-Mount Auxiliary Contacts

Contact Configuration	Contact Sequence	Pkg. Qty. ①	Screw Terminal Catalog Number
1NO-1NC		5	XTPAXFA11

Can be fitted to manual motor protectors (XTPB, XTPR, XTPM) and manual transformer protectors (XTPT). 45 mm (XTPR...B and XTPB) or 55 mm (XTPR...D) widths of manual motor protectors remain unchanged.

**Note**

① Orders must be placed in multiples of package quantity listed.

XTPAXSATR\_



## Side-Mount Trip Indicating Auxiliary Contacts

Contact Configuration	Contact Sequence	Pkg. Qty. ①	For Use with...	Catalog Number
2 x 1NO	<p>On/Off</p>	2	XTPE	XTPAXSATR20
2 x 1NC	<p>On/Off</p>	2	XTPE	XTPAXSATR02

Can be fitted on the right side of manual motor protectors. Can be combined with standard auxiliary contacts. Trip indication: A. General trip indication (overload) B. Short-circuit trip. Local short-circuit indication by red indicator, manually resettable.

**Note**

① Orders must be placed in multiples of package quantity listed.

### Additional Accessories

#### XTPAXSR\_



#### Contact Sequence

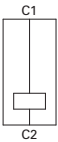

#### Shunt Release

Pkg. Qty. ①	Screw Terminal Catalog Number
2	XTPAXSR24V50H
2	XTPAXSR48V50H
2	XTPAXSR110V50H
2	XTPAXSR120V60H
2	XTPAXSR208V60H
2	XTPAXSR220V50H
2	XTPAXSR230V50H
2	XTPAXSR240V50H
2	XTPAXSR240V60H
2	XTPAXSR380V50H
2	XTPAXSR400V50H
2	XTPAXSR415V50H
2	XTPAXSR440V60H
2	XTPAXSR480V60H
2	XTPAXSR24VDC
2	XTPAXSR48VDC
2	XTPAXSR60VDC
2	XTPAXSR110VDC
2	XTPAXSR125VDC
2	XTPAXSR220VDC
2	XTPAXSR250VDC

Can be used to trip the manual motor protector from a remote location. Can be fitted on the left side of manual motor protectors. Cannot be combined with the XTPAXUVR. DC: Intermittent operation 5 sec.

#### XTPAXUVR\_



#### Contact Sequence



#### Undervoltage Release

Pkg. Qty. ①	Screw Terminal Catalog Number
2	XTPAXUVR24V50H
2	XTPAXUVR24V60H
2	XTPAXUVR48V50H
2	XTPAXUVR60V50H
2	XTPAXUVR110V50H
2	XTPAXUVR120V60H
2	XTPAXUVR208V60H
2	XTPAXUVR220V50H
2	XTPAXUVR230V50H
2	XTPAXUVR240V50H
2	XTPAXUVR240V60H
2	XTPAXUVR380V50H
2	XTPAXUVR400V50H
2	XTPAXUVR415V50H
2	XTPAXUVR440V60H
2	XTPAXUVR480V60H
2	XTPAXUVR600V60H

Can be used to trip the manual motor protector from a remote location. Can be fitted on left side manual motor protectors. Cannot be combined with XTPAXSR. When combined with a circuit breaker, it can be used as emergency-stop device to IEC/EN 60204.

#### Note

① Orders must be placed in multiples of package quantity listed.

## IP65 Rotary Handle Mechanism ①②③

Description	Enclosure Rating	Pkg. Qty. ④	Catalog Number
<b>Complete Kits—Includes Handle, Shaft and Required Hardware</b>			
Rotary handle mechanism—black ⑤	IP65	1	<b>XTPEXRHMB</b>
Rotary handle mechanism—red/yellow ⑥	NEMA 12 UL/CSA 4X	1	<b>XTPEXRHMR</b>
Rotary handle mechanism—black—rotated 90° from vertical ⑥		1	<b>XTPEXRHM90B</b>
Rotary handle mechanism—red/yellow—rotated 90° from vertical ⑥		1	<b>XTPEXRHM90R</b>



## Three-Phase Commoning Links ⑦

For Use with...	Qty. MMP	Length of Link (mm)	Unit Width (mm)	Pkg. Qty. ④	Catalog Number
MMP with no side-mounted auxiliaries or voltage releases	2	90	45	10	<b>XTPAXCLKA2</b>
	3	135	45	10	<b>XTPAXCLKA3</b>
	4	180	45	10	<b>XTPAXCLKA4</b>
	5	225	45	10	<b>XTPAXCLKA5</b>
Each MMP with one auxiliary contact or trip-indicating auxiliary contact fitted on the right	2	99	45 + 9	10	<b>XTPAXCLKB2</b>
	3	153	45 + 9	10	<b>XTPAXCLKB3</b>
	4	207	45 + 9	10	<b>XTPAXCLKB4</b>
	5	261	45 + 9	10	<b>XTPAXCLKB5</b>
Each MMP with an auxiliary contact and trip-indicating auxiliary contact mounted on the right or a voltage release mounted on the left.	2	108	45 + 18	10	<b>XTPAXCLKC2</b>

For parallel power feed to several manual motor protectors on terminals 1, 3 and 5.

## XTPAXUTS

## Shroud for Unused Terminals of Three-Phase Commoning Links



For Use with...	Description	Pkg. Qty. ④	Catalog Number
Frame B XTPE	To cover unused terminals on three-phase commoning link. Protected against direct contact.	20	<b>XTPAXUTS</b>

## XTPAXIT

## Incoming Terminals for Three-Phase Commoning Link ⑧



For Use with...	Pkg. Qty. ④	Catalog Number
Frame B XTPE	5	<b>XTPAXIT</b>

## Notes

- ① Plug-in connection shafts, XTPAXRHMSFT\_ can be cut to desired length for mounting depths of 100–240 mm. Carrier with extension shaft included.
- ② With ON/OFF switch position and “+” (tripped), lockable with 3 padlocks, 4–8 mm hasp. Can be locked in the OFF position, if required.
- ③ Rotary handle mechanisms ship with door interlock disabled. See instruction publication with product for how to enable door interlock.
- ④ Orders must be placed in multiples of package quantity listed.
- ⑤ For use on main switches to IEC/EN 60204.
- ⑥ For use on main switches with emergency-stop function to IEC/EN 60204.
- ⑦ Protected against accidental contact. Frame B short-circuit proof  $U_b = 690V$ ,  $I_u = 63A$ . Frame B links can be combined by rotating mounting.
- ⑧ For three-phase commoning link, protected against accidental contact,  $U_b = 690V$ ,  $I_u = 63A$ ;  
For conductor cross-sections: 2.5–25 mm<sup>2</sup> stranded; 2.5–16 mm<sup>2</sup> flexible with ferrules, AWG 14-6.

#### Combination Connection Kits

#### Non-Reversing Starters

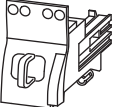
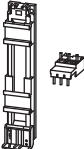
	For Use with...	Description/Comprised of ...	Std. Pack <sup>①</sup>	Catalog Number
<b>XTPAXTPCB</b> 	XTPE...B + XTCE...B	Mechanical connection element for XTPR...B and contactor	1	<b>XTPAXTPCB</b>
		Main current wiring between XTPR...B and contactor in toolless plug connection	1	
Use contactor auxiliary switch XTCEXFAT_. Control cable guidance: max. six cables up to 2.5 mm <sup>2</sup> external diameter or four cables up to 3.5 mm <sup>2</sup> external diameter.				
<b>XTPAXTPC_</b> 	XTPR...B + XTCE...C	DIN rail adapter plate	1	<b>XTPAXTPCC</b>
		Main current wiring between XTPR and contactor		

#### Reversing Starters

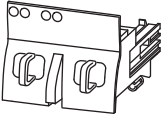
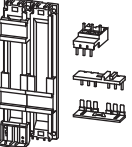
	For Use with...	Description/Comprised of ...	Std. Pack <sup>①</sup>	Catalog Number
<b>XTPAXTPCRB</b> 	XTPE...B + XTCE...B01_	Mechanical connection element for XTPR...B and contactor	1	<b>XTPAXTPCRB</b>
		Reversing starter main current wiring in toolless plug connection	1	
		Control cables for electrical interlocking in toolless plug connection:	1	
		– K1M: A1–K2M: Z1 – K1M: Z1–K2M: A1 – K1M: A2–K2M: A2		
		Cable guidance	1	
Use contactor auxiliary switch XTCEXFAT_. Control cable guidance: max. six cables up to 2.5 mm <sup>2</sup> external diameter or four cables up to 3.5 mm <sup>2</sup> external diameter.				
<b>XTPAXTPCRC</b> 	XTPE...B + XTCE...C	DIN rail adapter plate	1	<b>XTPAXTPCRC</b>
		Reversing starter main current wiring	1	

#### Note

<sup>①</sup> Orders must be placed in multiples of package quantity listed.

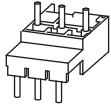

**XTPAXECM\_****Electrical Connection Module**

For Use with...	Description/Comprised of ...	Std. Pack <sup>①</sup>	Catalog Number
XTPE...B + XTCE...C	Main current wiring between XTPR...B and contactor	5	<b>XTPAXECMC</b>

**DIN Rail Adapter Plates****XTPAXTPCPB**

For Use with...	Description/Comprised of ...	Std. Pack <sup>①</sup>	Catalog Number
XTPE...B + XTCE...C	45 mm wide adapter plate with one DIN rail	4	<b>XTPAXTPCPB</b>
XTPAXTPCRB	Connection element for side-by-side positioning of further plates		

**PKE-SWD-32**

XTPE...B + XTCE...B or C	SmartWire-DT communication link	1	<b>PKE-SWD-32</b>
--------------------------	---------------------------------	---	-------------------

**Note**

<sup>①</sup> Orders must be placed in multiples of package quantity listed.

## Technical Data and Specifications

### XT Electronic Manual Motor Controllers

Description	Specification	XTPE012B	XTPE032B	XTPE065D
<b>General</b>				
Standards and regulations		IEC/EN 60947-4-1, VDE 0600, UL 508, CSA C 22.2 No. 14		
Climatic proofing		Damp heat, constant, to IEC 60068-2-78		
		Damp heat, cyclic, to IEC 60068-2-30		
Ambient temperature				
Storage		−40° to 80°C	−40° to 80°C	−40° to 80°C
Open		−25° to 55°C	−25° to 55°C	−25° to 55°C
Enclosed		−25° to 40°C	−25° to 40°C	−25° to 40°C
Direction of incoming supply		Any	Any	Any
Degree of protection	Device	IP20	IP20	IP20
	Terminals	IP00	IP00	IP00
Touch protection				
Mechanical shock resistance half-sinusoidal shock, 10 ms to IEC 60068-2-27		25g	25g	25g
Altitude		Max. 2000m	Max. 2000m	Max. 2000m
<b>Conductor Cross-Sections</b>				
Screw terminals	Solid	1 x (1–6) mm <sup>2</sup>	1 x (1–6) mm <sup>2</sup>	1 x (0.75–16) mm <sup>2</sup>
		2 x (1–6) mm <sup>2</sup>	2 x (1–6) mm <sup>2</sup>	2 x (0.75–16) mm <sup>2</sup>
	Stranded with ferrule to DIN 46228	1 x (1–6) mm <sup>2</sup>	1 x (1–6) mm <sup>2</sup>	1 x (0.75–35) mm <sup>2</sup>
		2 x (1–6) mm <sup>2</sup>	2 x (1–6) mm <sup>2</sup>	2 x (0.75–25) mm <sup>2</sup>
Solid or stranded	18–10 AWG	18–10 AWG	14–2 AWG	
<b>Screw Terminal Tightening Torque</b>				
Main conductor		1.7 Nm	1.7 Nm	3.3 Nm
Auxiliary conductor		1 Nm	1 Nm	1 Nm
<b>Main Circuit</b>				
Rated impulse withstand voltage	$U_{mp}$	6,000 Vac	6,000 Vac	6,000 Vac
Overvoltage category/pollution degree		III/3	III/3	III/3
Rated operational voltage	$U_e$	690V	690V	690V
Rated uninterrupted current = rated output current	$I_u = I_e$	12A	32A	65A
Rated frequency		40–60 Hz	40–60 Hz	40–60 Hz
Current heating losses (three-pole at operating temperature)		6W	6W	6W
Lifespan, mechanical	Operations	$0.05 \times 10^6$	$0.05 \times 10^6$	$0.05 \times 10^6$
Lifespan, electrical (AC-3 at 400V)	Operations	$0.05 \times 10^6$	$0.05 \times 10^6$	$0.05 \times 10^6$
Maximum operating frequency	Operations/h	60	60	60
<b>Short-Circuit Rating</b>				
Motor switching capacity AC	AC-3 up to 690V	12A	32A	65A
<b>Trip Unit</b>				
Temperature compensation to IEC/EN 60947, VDE 0660		−5° to 40°C	−5° to 40°C	−5° to 40°C
Operating range		−25° to 55°C	−25° to 55°C	−25° to 55°C
Temperature compensation residual error for T > 40°C		≤0.1%/K	≤0.1%/K	≤0.1%/K
Overload release setting range		0.25–1 $x I_u$	0.25–1 $x I_u$	0.25–1 $x I_u$
Fixed short-circuit trip setting		12 $x I_r$ (trip unit), 14 $x I_u$ (base)	12 $x I_r$ (trip unit), 14 $x I_u$ (base)	12 $x I_r$ (trip unit), 14 $x I_u$ (base)
Short circuit release tolerance		±20%	±20%	±20%
Phase failure sensitivity		Yes	Yes	Yes

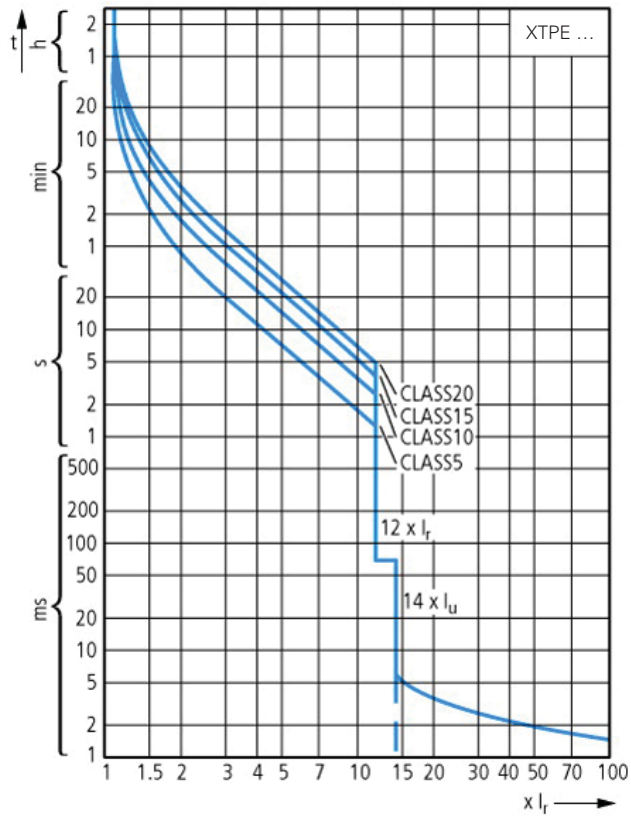
**Trip Characteristics****XT Electronic Manual Motor Controllers**

#### 1

### Dimensions

Approximate Dimensions in Inches (mm)

#### XT Electronic MMP—B Frame

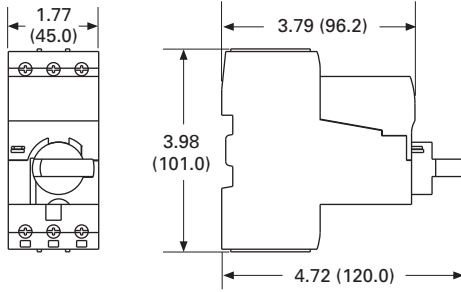

#### XT Electronic MMP—D Frame

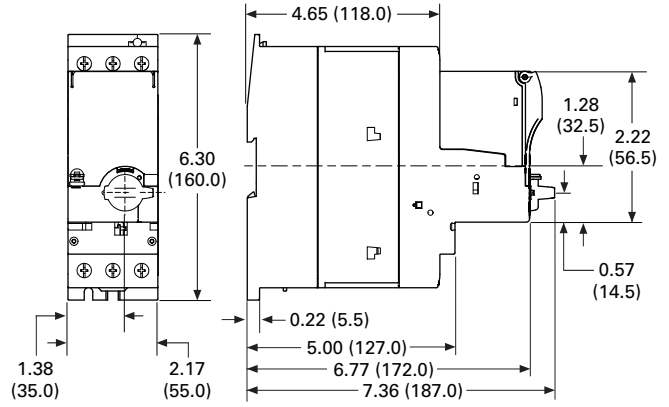

#### XT Electronic CMC With C Frame Contactor

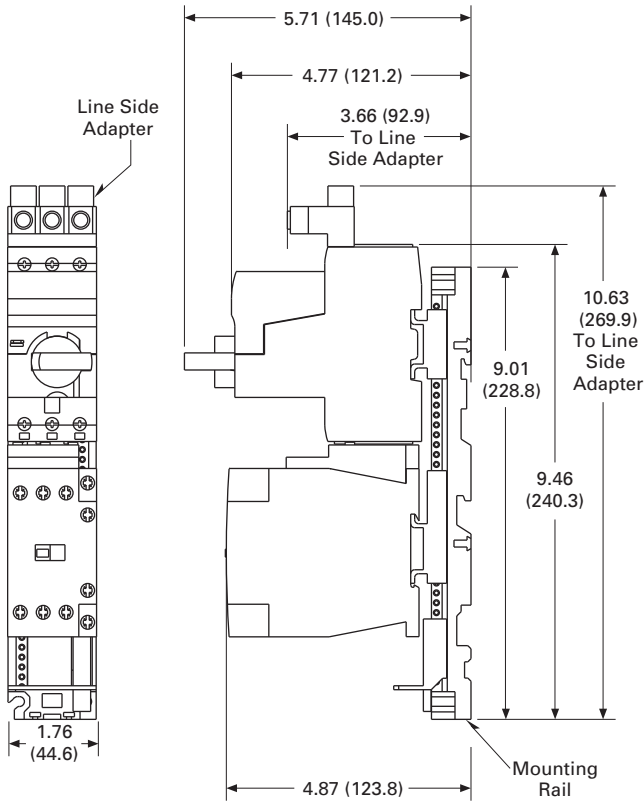

**Reference Data**

Type 2 Coordination . . . . .	<b>V5-T1-230</b>
Approvals for World Markets . . . . .	<b>V5-T1-239</b>
IEC Utilization Categories . . . . .	<b>V5-T1-242</b>
Motor Ratings Data . . . . .	<b>V5-T1-245</b>
Ampacities of Insulated Conductors (Based on 2005 NEC) . . . . .	<b>V5-T1-249</b>

**Type 1 and Type 2 Coordination****What is it?**

The International Electrotechnical Commission (IEC) developed short-circuit performance criteria for contactors and starters called Type 1 coordination and Type 2 coordination. This defines motor controller protection levels following a short-circuit fault. In order to achieve this performance, the combination of a motor controller (contactor or starter) and short-circuit protective device (manual motor protector, circuit breaker or fuse) must meet the following criteria as specified by IEC 60947-4-1—Low voltage switchgear and controlgear—Part 4-1: Contactors and motor-starters—Electromechanical contactors and motor-starters:

**Type 1 Coordination**

Type 1 Coordination requires that under short-circuit conditions, the contactor or starter shall cause no danger to persons or installation and may not be suitable for further service without repair and replacement of parts.

In this case, *significant damage is allowed* to the contactor/starter (for example, contact welding, burning or disintegration) and the overload relay (for example, component harm or heater element burn-out).

**Type 2 Coordination**

Type 2 Coordination requires that under short-circuit conditions, the contactor or starter shall cause no danger to persons or installation and shall be suitable for further use. The risk of contact welding is recognized, in which case the manufacturer shall indicate the measures to be taken as regards to the maintenance of the equipment.

## Type 2 Coordination

## 400, xx415V Type 2 Coordination—MMC

P (kW)	I <sub>b</sub> (A)	I <sub>g</sub> (kA)	MMP Catalog Number	Contactor Catalog Number <sup>②</sup>	MMC Catalog Number <sup>②</sup>
0.06	0.21	50 (150) <sup>①</sup>	XTPRP25BC1	XTCE007B10_	XTSCP25BB_
0.09	0.31	50 (150) <sup>①</sup>	XTPRP40BC1	XTCE007B10_	XTSCP40BB_
0.12	0.41	50 (150) <sup>①</sup>	XTPRP63BC1	XTCE007B10_	XTSCP63BB_
0.18	0.60	50 (150) <sup>①</sup>	XTPRP63BC1	XTCE007B10_	XTSCP63BB_
0.25	0.80	50 (150) <sup>①</sup>	XTPR001BC1	XTCE007B10_	XTSC001BB_
0.37	1.10	50 (150) <sup>①</sup>	XTPR1P6BC1	XTCE007B10_	XTSC1P6BB_
0.55	1.50	50 (150) <sup>①</sup>	XTPR1P6BC1	XTCE007B10_	XTSC1P6BB_
0.75	1.90	50 (150) <sup>①</sup>	XTPR2P5BC1	XTCE007B10_	XTSC2P5BB_
1.10	2.60	50 (150) <sup>①</sup>	XTPR004BC1	XTCE007B10_	XTSC004BB_
1.50	3.60	50 (150) <sup>①</sup>	XTPR004BC1	XTCE007B10_	XTSC004BB_
2.20	5.00	50 (150) <sup>①</sup>	XTPR6P3BC1	XTCE007B10_	XTSC6P3BB_
3.00	6.60	50 (150) <sup>①</sup>	XTPR010BC1	XTCE018C10_	XTSC010BC_
4.00	8.50	50 (150) <sup>①</sup>	XTPR010BC1	XTCE018C10_	XTSC010BC_
5.50	11.3	50	XTPR012BC1	XTCE018C10_	XTSC012BC_
7.50	16.0	50	XTPR016BC1	XTCE018C10_	XTSC016BC_
11.0	21.7	50	XTPR025BC1	XTCE025C10_	XTSC025BC_
15.0	29.3	50	XTPR032BC1	XTCE032C10_	XTSC032BC_
5.50	11.3	50	XTPR016DC1	XTCE018C10_	XTSC016DC_
7.50	16.0	50	XTPR016DC1	XTCE018C10_	XTSC016DC_
11.0	21.7	50	XTPR025DC1	XTCE025C10_	XTSC025DC_
15.0	29.3	50	XTPR032DC1	XTCE032C10_	XTSC032DC_
18.5	36.0	50	XTPR040DC1	XTCE040D00_	XTSC040DD_
22.0	41.0	50	XTPR050DC1	XTCE050D00_	XTSC050DD_
30.0	55.0	50	XTPR058DC1	XTCE065D00_	XTSC058DD_
34.0	63.0	50	XTPR063DC1	XTCE065D00_	XTSC063DD_

**Notes**

See **Page V5-T1-238** for more information on wye-delta (star delta) applications.

① Values in parentheses ( ) are for Type 1 Coordination.

② Underscore ( \_ ) indicates magnet coil suffix required. See **Page V5-T1-238**.

## 480V Type 2 Coordination – MMC

P (hp)	I <sub>e</sub> (A)	I <sub>q</sub> (kA)	MMP Catalog Number	Current Limiter Catalog Number	Contactor Catalog Number <sup>②</sup>	MMC Catalog Number <sup>②</sup>
1/2	0.24	65	XTPRP25BC1	—	XTCE007B10_	XTSCP25BB_
1/2	0.32	65	XTPRP40BC1	—	XTCE007B10_	XTSCP40BB_
1/2	0.51	65	XTPRP63BC1	—	XTCE007B10_	XTSCP63BB_
1/2	0.74	65	XTPR001BC1	—	XTCE007B10_	XTSC001BB_
1/2	0.94	65	XTPR001BC1	—	XTCE007B10_	XTSC001BB_
3/4	1.32	65	XTPR1P6BC1	—	XTCE007B10_	XTSC1P6BB_
1	1.72	65	XTPR2P5BC1	—	XTCE018C10_	XTSC2P5BC_
2	2.55	65	XTPR004BC1	—	XTCE018C10_	XTSC004BC_
2	3.10	65	XTPR004BC1	—	XTCE018C10_	XTSC004BC_
3	4.55	65 (50) <sup>①</sup>	XTPR6P3BC1	XTPAXCL	XTCE018C10_	XTSC6P3BC_
3	6.15	65 (50) <sup>①</sup>	XTPR6P3BC1	XTPAXCL	XTCE018C10_	XTSC6P3BC_
7-1/2	8.40	65 (50) <sup>①</sup>	XTPR010BC1	XTPAXCL	XTCE018C10_	XTSC010BC_
7-1/2	11.0	65 (50) <sup>①</sup>	XTPR012BC1	XTPAXCL	XTCE018C10_	XTSC012BC_
10	14.5	65 (50) <sup>①</sup>	XTPR016BC1	XTPAXCL	XTCE018C10_	XTSC016BC_
10	20.0	65 (50) <sup>①</sup>	XTPR020BC1	XTPAXCL	XTCE025C10_	XTSC020BC_
20	20.0	65	XTPR025DC1	—	XTCE040D00_	XTSC025DD_
25	27.0	65	XTPR032DC1	—	XTCE040D00_	XTSC032DD_
25	32.0	65	XTPR032DC1	—	XTCE040D00_	XTSC032DD_
30	37.5	65	XTPR040DC1	—	XTCE040D00_	XTSC040DD_
40	40.5	65	XTPR050DC1	—	XTCE050D00_	XTSC050DD_
40	50.5	65	XTPR058DC1	—	XTCE065D00_	XTSC058DD_
40	64.0	65	XTPR063DC1	—	XTCE065D00_	XTSC063DD_

## 600V Type 2 Coordination – MMC

P (hp)	I <sub>e</sub> (A)	I <sub>q</sub> (kA)	MMP Catalog Number	Current Limiter Catalog Number	Contactor Catalog Number <sup>②</sup>	MMC Catalog Number <sup>②</sup>
1/2	0.19	50	XTPRP25BC1	—	XTCE007B10_	XTSCP25BB_
1/2	0.26	50	XTPRP40BC1	—	XTCE007B10_	XTSCP40BB_
1/2	0.41	50	XTPRP63BC1	—	XTCE007B10_	XTSCP63BB_
1/2	0.59	50	XTPRP63BC1	—	XTCE007B10_	XTSCP63BB_
1/2	0.75	50	XTPR001BC1	—	XTCE007B10_	XTSC001BB_
1	1.06	50	XTPR1P6BC1	—	XTCE007B10_	XTSC1P6BB_
1	1.38	50	XTPR1P6BC1	—	XTCE007B10_	XTSC1P6BB_
1-1/2	2.04	50	XTPR2P5BC1	—	XTCE018C10_	XTSC2P5BC_
1-1/2	2.48	50	XTPR2P5BC1	—	XTCE018C10_	XTSC2P5BC_
3	3.64	50	XTPR004BC1	—	XTCE018C10_	XTSC004BC_
5	4.92	50 (18) <sup>①</sup>	XTPR6P3BC1	XTPAXCL	XTCE018C10_	XTSC6P3BC_
10	6.72	50 (18) <sup>①</sup>	XTPR010BC1	XTPAXCL	XTCE018C10_	XTSC010BC_
10	8.60	50 (18) <sup>①</sup>	XTPR010BC1	XTPAXCL	XTCE018C10_	XTSC010BC_
10	11.5	50 (18) <sup>①</sup>	XTPR012BC1	XTPAXCL	XTCE018C10_	XTSC012BC_
10	16.0	50 (18) <sup>①</sup>	XTPR016BC1	XTPAXCL	XTCE018C10_	XTSC016BC_
25	21.5	50	XTPR025DC1	—	XTCE040D00_	XTSC025DD_
30	25.5	50	XTPR032DC1	—	XTCE040D00_	XTSC032DD_
30	30.0	50	XTPR032DC1	—	XTCE040D00_	XTSC032DD_
30	37.5	50	XTPR040DC1	—	XTCE040D00_	XTSC050DD_
40	40.5	50	XTPR050DC1	—	XTCE050D00_	XTSC050DD_
40	51.0	42	XTPR058DC1	—	XTCE065D00_	XTSC058DD_
50	61.0	42	XTPR063DC1	—	XTCE065D00_	XTSC063DD_

**Notes**

See **Page V5-T1-238** for more information on wye-delta (star delta) applications.

① Values in parentheses ( ) are achieved without the current limiter.

② Underscore ( \_ ) indicates magnet coil suffix required. See **Page V5-T1-238**.

## 400, 415V Type 2 Coordination—Contactor and Overload Relay (Motor Starter) with Fused Disconnect

P (kW)	I <sub>e</sub> (A)	I <sub>q</sub> (kA)	Fuses Class gG/gL	Contactor Catalog Number <sup>①</sup>	Overload Relay Catalog Number	Assembled Starter Catalog Number <sup>①</sup>
0.12	0.41	100	2	XTCE007B10_	XTOB60BC1	XTAE007B10_P60
0.18	0.60	100	2	XTCE007B10_	XTOB001BC1	XTAE007B10_001
0.25	0.80	100	4	XTCE007B10_	XTOB001BC1	XTAE007B10_001
0.37	1.10	100	4	XTCE007B10_	XTOB1P6BC1	XTAE007B10_1P6
0.55	1.50	100	4	XTCE007B10_	XTOB1P6BC1	XTAE007B10_1P6
0.75	1.90	100	6	XTCE007B10_	XTOB2P4BC1	XTAE007B10_2P4
1.10	2.60	100	6	XTCE007B10_	XTOB004BC1	XTAE007B10_004
1.50	3.60	100	6	XTCE007B10_	XTOB004BC1	XTAE007B10_004
2.20	5.00	100	10	XTCE007B10_	XTOB006BC1	XTAE007B10_006
3.00	6.60	100	16	XTCE007B10_	XTOB010BC1	XTAE007B10_010
4.00	8.50	100	20	XTCE009B10_	XTOB010BC1	XTAE009B10_010
5.50	11.3	100	25	XTCE018C10_	XTOB016CC1	XTAE018C10_016
7.50	16.0	100	32	XTCE018C10_	XTOB016CC1	XTAE018C10_016
11.0	21.7	100	40	XTCE025C10_	XTOB024CC1	XTAE032C10_024
15.0	29.3	100	63	XTCE032C10_	XTOB032CC1	XTAE032C10_032
18.5	36.0	100	63	XTCE040D00_	XTOB040DC1	XTAE040D00_040
22.0	41.0	100	80	XTCE050D00_	XTOB057DC1	XTAE065D00_057
30.0	55.0	100	100	XTCE065D00_	XTOB057DC1	XTAE065D00_057
37.0	68.0	100	125	XTCE080F00_	XTOB070GC1	XTAE080F00_070
45.0	81.0	100	160	XTCE095F00_	XTOB100GC1	XTAE095F00_100
55.0	99.0	100	200	XTCE115G00_	XTOB100GC1	XTAE115G00_100
75.0	134.0	100	200	XTCE150G00_	XTOB150GC1	XTAE150G00_150
90.0	161.0	100	250	XTCE185L22_	XTOB220LC1	XTAE185L22_220
110.0	196.0	100	315	XTCE225L22_	XTOB220LC1	XTAE225L22_220
132.0	231.0	100	400	XTCE250L22_	XTOB250LC1	XTAE250L22_250
160.0	279.0	100	400	XTCE300M22_	XTOT290C35	XTAE300M22_290
200.0	349.0	100	500	XTCE400M22_	XTOT400C35	XTAE400M22_400
250.0	437.0	100	630	XTCE500M22_	XTOT540C35	XTAE500M22_540

**Notes**

See **Page V5-T1-238** for more information on wye-delta (star delta) applications.

<sup>①</sup> Underscore (\_) indicates magnet coil code required. See **Page V5-T1-238**.



## 500V Type 2 Coordination—Contactor and Overload Relay (Motor Starter) with Fused Disconnect

P (kW)	I <sub>e</sub> (A)	I <sub>q</sub> (kA)	Fuses Class gG/gL	Contactor Catalog Number <sup>①</sup>	Overload Relay Catalog Number	Assembled Starter Catalog Number <sup>①</sup>
0.12	0.33	100	2	XTCE007B10_	XTOBP40BC1	XTAE007B10_P40
0.18	0.48	100	2	XTCE007B10_	XTOBP60BC1	XTAE007B10_P60
0.25	0.70	100	2	XTCE007B10_	XTOB001BC1	XTAE007B10_001
0.37	0.90	100	2	XTCE007B10_	XTOB001BC1	XTAE007B10_001
0.55	1.20	100	4	XTCE007B10_	XTOB1P6BC1	XTAE007B10_1P6
0.75	1.50	100	4	XTCE007B10_	XTOB1P6BC1	XTAE007B10_1P6
1.10	2.10	100	6	XTCE007B10_	XTOB2P4BC1	XTAE007B10_2P4
1.50	2.90	100	6	XTCE007B10_	XTOB004BC1	XTAE007B10_004
2.20	4.00	100	10	XTCE007B10_	XTOB006BC1	XTAE007B10_006
3.00	5.30	100	16	XTCE009B10_	XTOB006BC1	XTAE009B10_006
4.00	6.80	100	16	XTCE009B10_	XTOB010BC1	XTAE009B10_010
5.50	9.00	100	20	XTCE012B10_	XTOB010BC1	XTAE012B10_010
7.50	12.1	100	25	XTCE018C10_	XTOB016CC1	XTAE018C10_016
11.0	17.4	100	32	XTCE025C10_	XTOB024CC1	XTAE025C10_024
15.0	23.4	100	50	XTCE040D00_	XTOB024DC1	XTAE040D00_024
18.5	28.9	100	50	XTCE040D00_	XTOB040DC1	XTAE040D00_040
22.0	33.0	100	63	XTCE050D00_	XTOB040DC1	XTAE050D00_040
30.0	44.0	100	80	XTCE065D00_	XTOB057DC1	XTAE065D00_057
37.0	54.0	100	100	XTCE080F00_	XTOB070GC1	XTAE080F00_070
45.0	65.0	100	125	XTCE095F00_	XTOB070GC1	XTAE095F00_070
55.0	79.0	100	160	XTCE115G00_	XTOB100GC1	XTAE115G00_100
75.0	107.0	100	200	XTCE185L22_	XTOB125LC1	XTAE185L22_125
90.0	129.0	100	200	XTCE185L22_	XTOB125LC1	XTAE185L22_125
110.0	157.0	100	250	XTCE185L22_	XTOB160LC1	XTAE185L22_160
132.0	184.0	100	250	XTCE185L22_	XTOB220LC1	XTAE185L22_220
160.0	224.0	100	315	XTCE225L22_	XTOB250LC1	XTAE225L22_250

**Notes**

See **Page V5-T1-238** for more information on wye-delta (star delta) applications.

① Underscore ( \_ ) indicates magnet coil code required. See **Page V5-T1-238**.

## 690V Type 2 Coordination—Contactor and Overload Relay (Motor Starter) with Fused Disconnect

P (kW)	I <sub>e</sub> (A)	I <sub>q</sub> (kA)	Fuses Class gG/gL	Contactor Catalog Number ①	Overload Relay Catalog Number	Assembled Starter Catalog Number ①
0.12	0.24	100	1	XTCE007B10_	XTOBP40BC1	XTAE007B10_P40
0.18	0.35	100	2	XTCE007B10_	XTOBP40BC1	XTAE007B10_P40
0.25	0.50	100	2	XTCE007B10_	XTOBP60BC1	XTAE007B10_P60
0.37	0.70	100	2	XTCE007B10_	XTOB001BC1	XTAE007B10_001
0.55	0.90	100	4	XTCE007B10_	XTOB001BC1	XTAE007B10_001
0.75	1.10	100	4	XTCE007B10_	XTOB1P6BC1	XTAE007B10_1P6
1.10	1.50	100	4	XTCE007B10_	XTOB1P6BC1	XTAE007B10_1P6
1.50	2.10	100	6	XTCE007B10_	XTOB2P4BC1	XTAE007B10_2P4
2.20	2.90	100	10	XTCE007B10_	XTOB004BC1	XTAE007B10_004
3.00	3.80	100	10	XTCE007B10_	XTOB004BC1	XTAE007B10_004
4.00	4.90	100	16	XTCE009B10_	XTOB006BC1	XTAE009B10_006
5.50	6.50	100	16	XTCE012B10_	XTOB010BC1	XTAE012B10_010
7.50	8.80	100	20	XTCE018C10_	XTOB010CC1	XTAE018C10_010
11.0	12.6	100	25	XTCE025C10_	XTOB016CC1	XTAE025C10_016
15.0	17.0	100	32	XTCE032C10_	XTOB024CC1	XTAE032C10_024
18.5	20.9	100	32	XTCE040D00_	XTOB024DC1	XTAE040D00_024
22.0	23.8	100	50	XTCE040D00_	XTOB040DC1	XTAE040D00_040
30.0	32.0	100	63	XTCE065D00_	XTOB040DC1	XTAE065D00_040
37.0	39.0	100	80	XTCE080F00_	XTOB050GC1	XTAE080F00_050
45.0	47.0	100	80	XTCE080F00_	XTOB050GC1	XTAE080F00_050
55.0	58.0	100	100	XTCE080F00_	XTOB070GC1	XTAE080F00_070
75.0	78.0	100	160	XTCE095F00_	XTOB100GC1	XTAE095F00_100
90.0	93.0	100	160	XTCE115G00_	XTOB100GC1	XTAE115G00_100
110.0	114.0	100	200	XTCE185L22_	XTOB125LC1	XTAE185L22_125
132.0	134.0	100	250	XTCE185L22_	XTOB160LC1	XTAE185L22_160
160.0	162.0	100	250	XTCE185L22_	XTOB220LC1	XTAE185L22_220

**Notes**

See **Page V5-T1-238** for more information on wye-delta (star delta) applications.

① Underscore ( \_ ) indicates magnet coil code required. See **Page V5-T1-238**.

## 400, 415V Type 2 Coordination—Contactor and Overload Relay (Motor Starter) with Fused Disconnect

P (kW)	I <sub>e</sub> (A)	I <sub>q</sub> (kA)	Fuses <sup>①</sup> Class BS88	Contactor Catalog Number <sup>②</sup>	Overload Relay Catalog Number	Assembled Starter Catalog Number <sup>②</sup>
0.12	0.41	80	4	XTCE007B10_	XTOBP60BC1	XTAE007B10_P60
0.18	0.60	80	4	XTCE007B10_	XTOBP60BC1	XTAE007B10_P60
0.25	0.80	80	4	XTCE007B10_	XTOB001BC1	XTAE007B10_001
0.37	1.10	80	6	XTCE007B10_	XTOB1P6BC1	XTAE007B10_1P6
0.55	1.50	80	10	XTCE007B10_	XTOB1P6BC1	XTAE007B10_1P6
0.75	1.90	80	16	XTCE007B10_	XTOB2P4BC1	XTAE007B10_2P4
1.10	2.60	80	16	XTCE007B10_	XTOB004BC1	XTAE007B10_004
1.50	3.60	80	20	XTCE007B10_	XTOB004BC1	XTAE007B10_004
2.20	5.00	80	20	XTCE007B10_	XTOB006BC1	XTAE007B10_006
3.00	6.60	80	20	XTCE007B10_	XTOB010BC1	XTAE007B10_010
4.00	8.50	80	25	XTCE009B10_	XTOB010BC1	XTAE009B10_010
5.50	11.3	80	25	XTCE018C10_	XTOB016CC1	XTAE018C10_016
7.50	16.0	80	25	XTCE018C10_	XTOB016CC1	XTAE018C10_016
11.0	21.7	80	35 and 32M35	XTCE025C10_	XTOB024CC1	XTAE032C10_024
15.0	29.3	80	50	XTCE032C10_	XTOB032CC1	XTAE032C10_032
18.5	36.0	80	63	XTCE040D00_	XTOB040DC1	XTAE040D00_040
22.0	41.0	80	80	XTCE050D00_	XTOB057DC1	XTAE065D00_057
30.0	55.0	80	100	XTCE065D00_	XTOB065DC1	XTAE065D00_065

**Notes**

See **Page V5-T1-238** for more information on wye-delta (star delta) applications.

① GEC/Alstom "Red Spot."

② Underscore ( \_ ) indicates magnet coil code required. See **Page V5-T1-238**.

## 400, 415V Type 2 Coordination—Contactor and Overload Relay (Motor Starter) with Circuit Breaker

P (kW)	I <sub>e</sub> (A)	I <sub>q</sub> (kA)	Circuit Breaker	Contactor Catalog Number ①	Overload Relay Catalog Number	Assembled Starter Catalog Number ①
0.12	0.41	15	②	②	②	②
0.18	0.60	15	②	②	②	②
0.25	0.80	15	②	②	②	②
0.37	1.10	15	②	②	②	②
0.55	1.50	15	②	②	②	②
0.75	1.90	15	②	②	②	②
1.10	2.60	15	②	②	②	②
1.50	3.60	15	②	②	②	②
2.20	5.00	15	②	②	②	②
3.00	6.60	15	②	②	②	②
4.00	8.50	15	HMCPPE015E0C	XTCE018C10_	XTOB010CC1	XTAE018C10_010
5.50	11.3	15	HMCPPE015E0C	XTCE018C10_	XTOB016CC1	XTAE018C10_016
7.50	16.0	15	②	②	②	②
11.0	21.7	15	②	②	②	②
15.0	29.3	15	②	②	②	②
18.5	36.0	50	②	②	②	②
22.0	41.0	50	HMCPPE100R3C	XTCE050D00_	XTOB057DC1	XTAE050D00_057
30.0	55.0	50	HMCPPE100R3C	XTCE065D00_	XTOB065DC1	XTAE065D00_065
37.0	68.0	80	HMCPJ250D5L	XTCE080F00_	XTOB070GC1	XTAE080F00_070
45.0	81.0	80	HMCPJ250F5L	XTCE095F00_	XTOB100GC1	XTAE095F00_100
55.0	99.0	80	HMCPJ250G5L	XTCE115G00_	XTOB125GC1	XTAE115G00_125
75.0	134.0	80	HMCPJ250J5L	XTCE150G00_	XTOB150GC1	XTAE150G00_150
90.0	161.0	80	HMCPJ250W5L	XTCE185L22_	XTOB220LC1	XTAE185L22_220
110.0	196.0	70	HMCPJ250W5L	XTCE225L22_	XTOB220LC1	XTAE225L22_220
132.0	231.0	70	HMCPJ600R6G	XTCE300M22_	XTOT240C3S	XTAE300M22_240
160.0	279.0	70	HMCPJ600X6G	XTCE300M22_	XTOT400C3S	XTAE300M22_400
200.0	349.0	70	HMCPJ600P6G	XTCE400M22_	XTOT400C3S	XTAE400M22_400
250.0	430.0	70	HMCPJ600M	XCE500M22_	XTOT540C3S	XTAE500M22_540

**Notes**

See **Page V5-T1-238** for more information on wye-delta (star delta) applications.

① Underscore (\_) indicates magnet coil code required. See **Page V5-T1-238**.

② Use MMP contactor combination. See **Page V5-T1-230**.

## 525V Type 2 Coordination—Contactor and Overload Relay (Motor Starter) with Circuit Breaker

P (kW)	I <sub>e</sub> (A)	I <sub>q</sub> (kA)	Circuit Breaker	Contactor Catalog Number <sup>①</sup>	Overload Relay Catalog Number	Assembled Starter Catalog Number <sup>①</sup>
0.37	1.02	50	②	②	②	②
0.55	1.22	50	②	②	②	②
0.75	1.66	50	②	②	②	②
1.10	2.22	50	②	②	②	②
1.50	3.16	50	②	②	②	②
2.20	4.25	50	②	②	②	②
3.00	5.60	50	②	②	②	②
4.00	7.50	50	②	②	②	②
5.50	9.90	50	②	②	②	②
7.50	14.1	50	②	②	②	②
11.0	19.3	50	②	②	②	②
15.0	23.5	50	②	②	②	②
18.5	27.2	50	②	②	②	②
22.0	37.0	50	②	②	②	②
30.0	45.0	50	②	②	②	②
37.0	54.0	50	HMCP100R3C	XTCE080F00_	XTOB070GC1	XTAE080F00_070
45.0	66.0	50	HMCPJ250D5L	XTCE080F00_	XTOB070GC1	XTAE080F00_070
55.0	79.0	50	HMCPJ250F5L	XTCE115G00_	XTOB100GC1	XTAE115G00_100
75.0	111.0	50	HMCPJ250J5L	XTCE115G00_	XTOB125GC1	XTAE115G00_125
90.0	130.0	50	HMCPJ250K5L	XTCE185L00_	XTOB160LC1	XTAE185L00_160
110.0	159.0	50	HMCPJ250W5L	XTCE185L00_	XTOB160LC1	XTAE185L00_160
132.0	185.0	50	HMCPJ600N6G	XTCE185L22_	XTOB220LC1	XTAE185L22_220
160.0	225.0	50	HMCPJ600R6G	XTCE225L22_	XTOB250LC1	XTAE225L22_250
200.0	270.0	50	HMCPJ600X6G	XTCE300M22_	XTOT290C3S	XTAE300M22_290

## 480V Type 2 Coordination—Contactor and Overload Relay (Motor Starter) with Circuit Breaker

P (hp)	I <sub>e</sub> (A)	I <sub>q</sub> (kA)	Circuit Breaker	Contactor Catalog Number <sup>①</sup>	Overload Relay Catalog Number	Assembled Starter Catalog Number <sup>①</sup>
50.0	65.0	65	HMCPJ250D5L	XTCE080F00_	XTOB070GC1	XTAE080F00_070
60.0	77.0	65	HMCPJ250G5L	XTCE080F00_	XTOB100GC1	XTAE080F00_100
75.0	96.0	25	HMCPJ250J5L	XTCE115G00_	XTOB125GC1	XTAE115G00_125
100.0	124.0	50	HMCPJ250K5L	XTCE185L22_	XTOB160LC1	XTAE185L22_160
125.0	156.0	50	HMCPJ250W5L	XTCE185L22_	XTOB160LC1	XTAE185L22_160
150.0	180.0	25	HMCPJ600N6G	XTCE225L22_	XTOB220LC1	XTAE225L22_220
200.0	240.0	50	HMCPJ600N	XTCE300M22_	XTOB240C3S	XTAE300M22_240
250.0	290.0	50	HMCPJ600R	XTCE300M22_	XTOB290C3S	XTAE300M22_290
300.0	361.0	50	HMCPJ600Y	XTCE400M22_	XTOB400C3S	XTAE400M22_400
350.0	414.0	50	HMCPJ600M	XTCE500M22_	XTOB540C3S	XTAE500M22_540

**Notes**

See **Page V5-T1-238** for more information on wye-delta (star delta) applications.

① Underscore (\_) indicates magnet coil code required. See **Page V5-T1-238**.

② Use MMP contactor combination.

#### 400, 415V Type 2 Coordination—Contactor with Circuit Breaker <sup>①</sup>

P (kW)	I <sub>e</sub> (A)	I <sub>g</sub> (kA)	Circuit Breaker—MCP	Contactor Catalog Number <sup>②</sup>
1.50	3.60	50	HMCPE015E0C	XTCE018C10_
2.20	5.00	50	HMCPE015E0C	XTCE018C10_
3.00	6.60	50	HMCPE015E0C	XTCE018C10_
4.00	8.50	50	HMCPE015E0C	XTCE018C10_
5.50	11.3	50	HMCPE015E0C	XTCE018C10_
7.50	16.0	50	HMCPE015E0C	XTCE018C10_
11.0	21.7	50	HMCPE100R3C	XTCE040D00_
15.0	29.3	50	HMCPE100R3C	XTCE040D00_
18.5	36.0	50	HMCPE100R3C	XTCE040D00_
22.0	41.0	50	HMCPE100R3C	XTCE050D00_
30.0	55.0	50	HMCPE100R3C	XTCE065D00_
37.0	68.0	80	HMCPJ250D5L	XTCE080F00_
45.0	81.0	80	HMCPJ250F5L	XTCE095F00_
55.0	99.0	80	HMCPJ250G5L	XTCE115G00_
75.0	134.0	80	HMCPJ250J5L	XTCE150G00_
90.0	161.0	80	HMCPJ250W5L	XTCE185L22_
110.0	196.0	80	HMCPJ250W5L	XTCE225L22_
132.0	231.0	70	HMCPL600R	XTCE300M22_
160.0	279.0	70	HMCPL600X	XTCE300M22_
200.0	350.0	70	HMCPL600P	XTCE400M22_
250.0	430.0	70	HMCPL600M	XTCE500M22_

#### Magnet Coil Suffix

##### Frames A–B

Coil Voltage	Suffix Code
110V 50 Hz, 120V 60 Hz	<b>A</b>
220V 50 Hz, 240V 60 Hz	<b>B</b>
230V 50 Hz	<b>F</b>
24V 50/60 Hz	<b>T</b>
24 Vdc	<b>TD</b> <sup>③</sup>
415V 50 Hz, 480V 60 Hz	<b>C</b>
600V 60 Hz	<b>D</b>
208V 60 Hz	<b>E</b>
190V 50 Hz, 220V 60 Hz	<b>G</b>
240V 50 Hz, 277V 60 Hz	<b>H</b>
380V 50 Hz, 440V 60 Hz	<b>L</b>
400V 50 Hz	<b>N</b>
380V 60 Hz	<b>P</b>
12V 50/60 Hz	<b>R</b>
24V 50 Hz	<b>U</b>
42V 50 Hz, 48V 60 Hz	<b>W</b>
48V 50 Hz	<b>Y</b>
120 Vdc	<b>AD</b> <sup>③</sup>
220 Vdc	<b>BD</b> <sup>③</sup>
12 Vdc	<b>RD</b> <sup>③</sup>
48 Vdc	<b>WD</b> <sup>③</sup>

##### Frames C–F

Coil Voltage	Suffix Code
110V 50 Hz, 120V 60 Hz	<b>A</b>
220V 50 Hz, 240V 60 Hz	<b>B</b>
230V 50 Hz	<b>F</b>
24V 50/60 Hz	<b>T</b>
24–27 Vdc	<b>TD</b> <sup>③</sup>
415V 50 Hz, 480V 60 Hz	<b>C</b>
600V 60 Hz	<b>D</b>
208V 60 Hz	<b>E</b>
190V 50 Hz, 220V 60 Hz	<b>G</b>
240V 50 Hz, 277V 60 Hz	<b>H</b>
380V 50 Hz, 440V 60 Hz	<b>L</b>
400V 50 Hz	<b>N</b>
380V 60 Hz	<b>P</b>
12V 50/60 Hz	<b>R</b>
24V 50 Hz	<b>U</b>
42V 50 Hz, 48V 60 Hz	<b>W</b>
48V 50 Hz	<b>Y</b>
110–130 Vdc	<b>AD</b> <sup>③</sup>
200–240 Vdc	<b>BD</b> <sup>③</sup>
12–14 Vdc	<b>RD</b> <sup>③</sup>
48–60 Vdc	<b>WD</b> <sup>③</sup>

#### 480V Type 2 Coordination—Contactor with Circuit Breaker <sup>①</sup>

P (hp)	I <sub>e</sub> (A)	I <sub>g</sub> (kA)	Circuit Breaker—MCP	Contactor Catalog Number <sup>②</sup>
50.0	65.0	65	HMCPJ250G5L	XTCE080F00_
60.0	77.0	65	HMCPJ250G5L	XTCE080F00_
150.0	180.0	50	HMCPL600N	XTCE300M00_
200.0	240.0	50	HMCPL600N	XTCE300M22_
250.0	300.0	50	HMCPL600R	XTCE300M22_
300.0	361.0	50	HMCPL600Y	XTCE400M00_
350.0	414.0	50	HMCPL600M	XTCE500M00_

##### Frame G

Coil Voltage	Suffix Code
100–120V 50/60 Hz	<b>A</b>
190–240V 50/60 Hz	<b>B</b>
24V 50/60 Hz	<b>T</b>
24–27 Vdc	<b>TD</b> <sup>③</sup>
480–500V 50/60 Hz	<b>C</b>
380–440V 50/60 Hz	<b>L</b>
42–48V 50/60 Hz	<b>W</b>
110–130 Vdc	<b>AD</b> <sup>③</sup>
200–240 Vdc	<b>BD</b> <sup>③</sup>
48–60 Vdc	<b>WD</b> <sup>③</sup>

##### Frames L–M

Coil Voltage	Suffix Code
110–250V 40–60 Hz/DC	<b>A</b>
250–500V 40–60 Hz/DC	<b>C</b>
48–110V 40–60 Hz/DC	<b>Y</b> <sup>③</sup>
24–48 Vdc	<b>TD</b> <sup>③</sup>

#### Wye-Delta (Star-Delta) Applications

If Type 2 Coordination is required when using wye-delta starters, the full voltage (direct on-line) test data that is included in this document is valid. To ensure proper

protection, the K1M (main), K3M (star) and K5M (delta) contactors must all be the same size (amperage). For wye-delta starter kits, please see **Page V5-T1-55**.

#### Notes

- ① For use with magnetic sensing means to monitor motor current.
- ② Underscore ( \_ ) indicates magnet coil code required. See magnet coil suffix tables on this page.
- ③ With DC operation: integrated diode-resistor combination, coil rating 2.6W.

## Approvals for World Markets

### Overview

The **XT** line of products is approved for use throughout the world, including the USA and Canada. As such, they can be used without restriction as devices for world markets.

The majority of countries permit the import of devices on the manufacturer's undertaking that they have been constructed in accordance with the pertinent specifications. In the USA and Canada, however, there is a legal obligation to obtain official approval. In these countries, devices and enclosures—sometimes even complete control systems—are tested and approved by independent bodies.

In Europe, there also used to be a legal obligation to obtain official approval for low-voltage switchgear and controlgear. For industrial control gear, this legal obligation has now been abolished, provided the devices have been manufactured and tested in accordance with harmonized European standards (such as IEC/EN 60947). There is then no longer a requirement for them to carry their country's own approval mark.

Since January 1997, all devices must conform to the European Low-Voltage Directive and, where intended for sale within the European Union, must carry the CE mark.

**Europe**  
Conformité Européen (CE)



This mark denotes that the device carrying it conforms to all relevant requirements and specifications. The mandatory application of this mark therefore enables the unrestricted use of marked devices within the European economic area.

Since January 1996, all devices sold within the European union must comply with the Electromagnetic Compatibility (EMC) Directive. **XT** has passed the required tests to these Directives and the devices carry the CE mark, demonstrating compliance with the EMC Directive. *Because devices bearing the CE mark comply with the harmonized standards, approval and the associated marking is no longer required in the following countries:*

**Belgium**  
Comité Electro-technique Belge  
Belgisch Elektro-technisch Comité (CEBEC)



**Denmark**  
Danmarks Elektriske Materielkontrol (DEMKO)



**Finland**  
(FIMKO)



**France**  
Union Technique de l'Electricité (UTE)



**Netherlands**  
Naamloze Vennootschap tot Keuring van Electrotechnische Materialen (KEMA)



**Norway**  
Norges Elektriske Materielkontrol (NEMKO)



**Sweden**  
Svenska Elektriska Materiel-Kontrollanstalten (SEMKO)



**Switzerland**  
Schweizerischer Elektrotechischer Verein (SEV)



Devices in the USA and Canada have UL and CSA approval.

**USA**  
Underwriters Laboratories (UL)



**Listing Recognition**



**Canada**  
Canadian Standards Association (CSA)



Recently introduced is the mandatory approval of electrical products for:

- Slovakia
- Poland
- South Africa
- China
- Russia
- Turkey
- Argentina

Marking is partly mandatory for these countries. The IEC rating data is accepted as in other European countries.

Approval is not mandatory in the Czech Republic and Hungary. The manufacturer's declaration of conformity is sufficient here.

Romania requires that components that are to be used in public buildings must be approved by the Romanian test authority ICECON.

**Russia**  
Devices for Russia must bear the appropriate marking.



**Russia**  
Goststandart (GOST-R)

**South Africa**  
ZA  
SABS



**Argentina**



### Selection of Devices

"Selection appropriate for export" does not mean merely meeting the requisite approvals and conformity to relevant specifications. The meaning of the term goes a great deal further by even including that equipment and installations must be designed to a concept with export in mind.

1 The following are important criteria for selecting switchgear suitable for export:

#### For motor-protective circuit breakers

Use inherently short-circuit proof switches capable of controlling the highest prospective fault levels at the point of installation without the need for back-up protection.

#### Advantage:

- No restrictions whatsoever for installation
- Complete independence from the on-site protective system
- No problems getting spare parts

#### For circuit breakers

Use types with visible contacts, quick-make and quick-break operation as standard. Use current-limiting circuit breakers for high short-circuit levels. Selective switches are recommended for the selective graduation of networks.

#### Advantage:

- Independence from local accident prevention regulations requiring visible contacts and safety faults caused by inexperienced operating personnel.
- The effects of short-circuits are kept to a minimum.
- Fuseless installations offer greater safety and reliability in plant operation. In the event of a fault, only the faulty section of the system is isolated.

#### For contactors

Use contactors whose entire range provides consistently reliable operation in the event of voltage drops (consistently down to 80%  $U_n$  should be aimed for) and whose contact system will not assume an indeterminate position either on closing or on opening in such conditions.

#### Advantage:

- During electrification work in areas such as Africa and the Middle East, an insufficient voltage stability is—at least for a certain time—likely in many applications (for example due to long spur lines or small local generators). The use of devices that fulfill the above requirements will eliminate one of the main failure causes related to contactors.

#### For enclosures

Use insulated enclosures with transparent covers (that is, “totally insulated” enclosures).

#### Advantage:

- Total insulation is the best possible protective measure from the user’s point of view, avoiding reliance on the possibly doubtful skills of unknown installation personnel. Furthermore, protective measures based on earthing are often extremely difficult, if not impossible (in the Middle East, for example, due to the dryness of the ground).
- Insulated enclosures completely eliminate the need for any additional protection against corrosion. The transparent covers contribute significantly to the correct operation of a system, because switchgear operation can be monitored even with the doors or covers closed, thus virtually eliminating the possibility of these being left open through carelessness. The transparent cover is an important contribution to safety, especially where exports to areas of uncertain skills are concerned.

#### For overcurrent protective devices

Always use circuit breakers and motor-protective circuit breakers. Avoid fuses as much as possible.

#### Advantage:

- The operational reliability of a system is especially important for export contracts. Circuit breakers and motor-protective circuit breakers provide this reliability in full measure since they can be immediately reclosed once a fault has been cleared, they disconnect all poles, they have ideal protection through high tripping accuracy and they can be used for selective operation. Because they have no fuses or other consumables, they also greatly reduce the problem of obtaining replacement parts. The advantages of fuseless design for export are especially evident in this case. No complicated investigation is needed to find out which fusing system is used in the respective location and which specifications have to be followed to select the correct fuses. Often several different fuse systems with widely varying characteristics are used side-by-side in the same country. For the uninitiated, it may be almost impossible to find the right fuse in these circumstances. These problems do not arise where a circuit breaker is used.



**For main switches and safety switches**

Use devices with positive contact separation and clear switch position indication.

**Advantage:**

- The mechanical coupling of the actuating element with the contacts ensures that the OFF position is indicated only when all main contacts are separated by the prescribed distance and only in this position can the switch be padlocked. This ensures safety when carrying out maintenance and repair work on the installation or machinery.

**Test Authorities**

<b>USA</b> USA UL	
<b>Canada</b> CDN CSA	 ML PAT
<b>Romania</b> RO ICECON	
<b>Russia</b> RUS GOST-R	
<b>South Africa</b> ZA SABS	
<b>Slovakia</b> SK SKTC	
<b>Poland</b> PL BBJ-SEP	
<b>Turkey</b> TR TSE	
<b>China</b> PRC CCC	
<b>Ukraine</b> UA Ukrain-GOST	

**Shipping Classifications**

<b>Germany</b> Germanischer Lloyd (GL)	
<b>Great Britain</b> Lloyd's Register of Shipping (LR)	
<b>France</b> Bureau Veritas (BV)	
<b>Russia</b> Russian Maritime Register of Shipping (RS)	
<b>Italy</b> Registro Italiano Navale (RINA)	
<b>Norway</b> Det Norske Veritas(DNV)	
<b>Poland</b> Polski Rejestr Statkow (PRS)	

**Approvals for North America**





In the U.S., the legally established OSHA (Occupational Safety and Health Act) and the NEC (National Electrical Code) require the use of approved devices and systems.

In Canada, all electrical apparatus must comply with the CEC (Canadian Electrical Code), which requires that all equipment and installations have CSA approval.

In addition to the normal UL and CSA approvals, the trade regulations originating from the NAFTA agreements allow the application for a joint UL and CSA approval. The devices then carry a logo that is recognized in both countries.

Some local inspectors and end users still refuse to accept the joint listing.

**Approvals for North America**

Type of Approval	Approval Mark
The device is UL- and CSA-approved as discrete device.	
The device is CSA-approved as discrete device.	
The device is UL-approved as discrete device.	
The device contains UL-approved components; its approval conditions must be maintained in use (UL Recognized). The device is CSA-approved as discrete device.	

**IEC Utilization Categories**

(See also IEC/EN 60947-1; 2.1.18/IEV 441-17-19)

A combination of specified requirements relating to the condition in which the switching device or fuse fulfills its purpose and selected to represent a characteristic group of real-life applications. The specified requirements may,

for example, relate to the values of making and breaking capacity and other characteristic values, data concerning associated circuits and the applicable conditions of use and operational behavior.

**Used in Technical Data and Formula**

Code	Description
DF	Duty factory
$I_{Dn}$	Response value of earth-fault release
$I_{cm}$	Rated short-circuit making capacity
$I_{cn}$	Rated short-circuit breaking capacity
$I_{cs}$	Rated service short-circuit breaking capacity
$I_{cu}$	Rated ultimate short-circuit breaking capacity
$I_{cw}$	Rated short-time withstand current
$I_e$	Rated operational current
$I_k$	Transformer initial short-circuit AC current
$I_L$	Load monitoring response value
$I_n$	Rated current
$I_{NT}$	Transformer rated current
$I_{PK}$	Rated peak withstand current
$I_q$	Rated conditional short-circuit current
$I_r$	Overcurrent release set value
$I_{rm}$	Response value of non-delayed short-circuit release
$I_i$	Response value of non-delayed short-circuit release
$I_{rmf}$	Response value of fixed, non-delayed short-circuit release

Code	Description
$I_{mv}$	Response value of short-time delayed short-circuit release
$I_{sd}$	Response value of short-time delayed short-circuit release
$I_T$	Response value of earth-fault release
$I_g$	Response value of earth-fault release
$I_{th}$	Conventional free air thermal current
$I_{the}$	Conventional thermal current of enclosed devices
$I_u$	Rated uninterrupted current
$S_{NT}$	Transformer rating
$t_r$	Time delay of overload release response
$t_T$	Time delay of earth-fault release response
$t_g$	Time delay of earth-fault release response
$t_v$	Time delay of short-circuit release response
$U_c$	Rated actuating voltage
$U_o$	Rated operational voltage
$U_i$	Rated insulation voltage
$U_{imp}$	Rated impulse withstand voltage
$U_k$	Transformer short-circuit voltage
$U_s$	Rated control voltage

**Annex A (informative)****Examples of Utilization Categories for Low Voltage Switchgear and Controlgear** <sup>①</sup>

Category	Typical Application	Relevant IEC Product Standard
<b>Nature of Current—AC</b>		
AC-1	Non-inductive or slightly inductive loads, resistance furnaces	60947-4-1
AC-2	Slip-ring motors: starting, switching off	60947-4-1
AC-3	Squirrel cage motors: starting, switching off motors during running	60947-4-1
AC-4	Squirrel cage motors: starting, plugging <sup>②</sup> , inching <sup>③</sup>	60947-4-1
AC-5a	Switching of electric discharge lamp controls	60947-4-1
AC-5b	Switching of incandescent lamps	60947-4-1
AC-6a	Switching of transformers	60947-4-1
AC-6b	Switching of capacitor banks	60947-4-1
AC-7a	Slightly inductive loads for household appliances and similar applications	61095
AC-7b	Motor-loads for household applications	61095
AC-8a	Hermetic refrigerant compressor motor control with manual resetting of overload releases	60947-4-1
AC-8b	Hermetic refrigerant compressor motor control with automatic resetting of overload releases	60947-4-1
AC-12	Control of resistive loads and solid-state loads with isolation by optocouplers	60947-5-1
AC-12	Control of resistive loads and solid-state loads with optical isolation	60947-5-2
AC-13	Control of solid-state loads with transformer isolation	60947-5-1
AC-14	Control of small electromagnetic loads	60947-5-1
AC-15	Control of AC electromagnetic loads	60947-5-1
AC-20	Connecting and disconnecting under no-load conditions	60947-3
AC-21	Switching of resistive loads, including moderate overloads	60947-3
AC-22	Switching of mixed resistive and inductive loads, including moderate overloads	60947-3
AC-23	Switching of motor loads or other highly inductive loads	60947-3
AC-31	Non-inductive or slightly inductive loads	60947-6-1
AC-33	Motor loads or mixed loads including motors, resistive loads and up to 30% incandescent lamp loads	60947-6-1
AC-35	Electric discharge lamp loads	60947-6-1
AC-36	Incandescent lamp loads	60947-6-1
AC-40	Distribution circuits comprising mixed resistive and reactive loads having a resultant inductive reactance	60947-6-2
AC-41	Non-inductive or slightly inductive loads, resistance furnaces	60947-6-2
AC-42	Slip-ring motors: starting, switching off	60947-6-2
AC-43	Squirrel cage motors: starting, switching off motors during running	60947-6-2
AC-44	Squirrel cage motors: starting, plugging <sup>②</sup> , inching <sup>③</sup>	60947-6-2
AC-45a	Switching of electric discharge lamp controls	60947-6-2
AC-45b	Switching of incandescent lamps	60947-6-2
AC-51	Non-inductive or slightly inductive loads, resistance furnaces	60947-4-3
AC-52a	Control of slip ring motor stators: 8 h duty with on-load currents for start, acceleration, run	60947-4-2
AC-52b	Control of slip ring motor stators: intermittent duty	60947-4-2
AC-53a	Control of squirrel cage motors: 8 h duty with on-load currents for start, acceleration, run	60947-4-2
AC-53b	Control of squirrel cage motors: intermittent duty	60947-4-2
AC-55a	Switching of electric discharge lamp controls	60947-4-3
AC-55b	Switching of incandescent lamps	60947-4-3
AC-56a	Switching of transformers	60947-4-3
AC-56b	Switching of capacitor banks	60947-4-3

**Notes**

① 60947-1 © IEC: 2004.

② Plugging is stopping or reversing the motor rapidly by reversing motor primary connections while the motor is running.

③ Inching (jogging) is energizing a motor once or repeatedly for short periods to obtain small movements of the driven mechanism.

Examples of Utilization Categories for Low-Voltage Switchgear and Controlgear, continued <sup>①</sup>

Category	Typical Application	Relevant IEC Product Standard
<b>Nature of Current—AC, continued</b>		
AC-58a	Control of hermetic refrigerant compressor motors with automatic resetting of overload releases: h duty with on-load currents for start, acceleration, run	60947-4-2
AC-58b	Control of hermetic refrigerant compressor motors with automatic resetting of overload releases: intermittent duty	60947-4-2
AC-140	Control of small electromagnetic loads with holding (closed) current $\leq 0,2$ A, for example, contactor relays	60947-5-2
<b>Nature of Current—AC and DC</b>		
A	Protection of circuits, with no rated short-time withstand current	60947-2
B	Protection of circuits, with a rated short-time withstand current	60947-2
<b>Nature of Current—DC</b>		
DC-1	Non-inductive or slightly inductive loads, resistance furnaces	60947-4-1
DC-3	Shunt-motors: starting, plugging <sup>②</sup> , inching <sup>③</sup> , dynamic breaking of motors	60947-4-1
DC-5	Series-motors: starting, plugging <sup>②</sup> , inching <sup>③</sup> , dynamic breaking of motors	60947-4-1
DC-6	Switching of incandescent lamps	60947-4-1
DC-12	Control of resistive loads and solid-state loads with isolation by optocouplers	60947-5-1
DC-12	Control of resistive loads and solid-state loads with optical isolation	60947-5-2
DC-13	Control of electromagnets	60947-5-1
DC-13	Control of electromagnets	60947-5-2
DC-14	Control of electromagnetic loads having economy resistors in circuit	60947-5-1
DC-20	Connecting and disconnecting under no-load conditions	60947-3
DC-21	Switching of resistive loads, including moderate overloads	60947-3
DC-22	Switching of mixed resistive and inductive loads, including moderate overloads (for example, shunt motors)	60947-3
DC-23	Switching of motor loads or other highly inductive loads (for example, series motors)	60947-3
DC-31	Resistive loads	60947-6-1
DC-33	Motor loads or mixed loads including motors	60947-6-1
DC-36	Incandescent lamp loads	60947-6-1
DC-40	Distribution circuits comprising mixed resistive and reactive loads having a resultant inductive reactance	60947-6-2
DC-41	Non-inductive or slightly inductive loads, resistance furnaces	60947-6-2
DC-43	Shunt-motors: starting, plugging <sup>②</sup> , inching <sup>③</sup> , dynamic breaking of DC	60947-6-2
DC-45	Series-motors: starting, plugging <sup>②</sup> , inching <sup>③</sup> , dynamic breaking of DC	60947-6-2
DC-46	Switching of incandescent lamps	60947-6-2

**Notes**

<sup>①</sup> 60947-1 © IEC: 2004.

<sup>②</sup> Plugging is stopping or reversing the motor rapidly by reversing motor primary connections while the motor is running.

<sup>③</sup> Inching (jogging) is energizing a motor once or repeatedly for short periods to obtain small movements of the driven mechanism.

## Motor Ratings Data

### Ampere Rating of AC and DC Motors

Ampere ratings of motors vary somewhat, depending upon the type of motor. The values given below are for drip-proof, Class B insulated (T Frame) where available, 1.15 service factor, NEMA Design B motors. These values represent an average full load motor current that was calculated from the motor performance data published by several motor manufacturers. In the case of high torque squirrel cage motors, the ampere ratings will be at least 10% greater than the values given below.

**Caution—** These average ratings could be high or low for a specific motor and therefore heater coil selection on this basis always involves risk. For fully reliable motor protection, select heater coils on the basis of full load current rating as shown on the motor nameplate.

### Ampere Ratings of Three-Phase, 60 Hz, AC Induction Motor

hp	Syn. Speed RPM	Current in Amperes				
		200V	230V	380V <sup>①</sup>	460V	575V
1/4	1800	1.09	0.95	0.55	0.48	0.38
	1200	1.61	1.40	0.81	0.70	0.56
	900	1.84	1.60	0.93	0.80	0.64
1/3	1800	1.37	1.19	0.69	0.60	0.48
	1200	1.83	1.59	0.92	0.80	0.64
	900	2.07	1.80	1.04	0.90	0.72
1/2	1800	1.98	1.72	0.99	0.86	0.69
	1200	2.47	2.15	1.24	1.08	0.86
	900	2.74	2.38	1.38	1.19	0.95
3/4	1800	2.83	2.46	1.42	1.23	0.98
	1200	3.36	2.92	1.69	1.46	1.17
	900	3.75	3.26	1.88	1.63	1.30
1	3600	3.22	2.80	1.70	1.40	1.12
	1800	4.09	3.56	2.06	1.78	1.42
	1200	4.32	3.76	2.28	1.88	1.50
	900	4.95	4.30	2.60	2.15	1.72
1-1/2	3600	5.01	4.36	2.64	2.18	1.74
	1800	5.59	4.86	2.94	2.43	1.94
	1200	6.07	5.28	3.20	2.64	2.11
	900	6.44	5.60	3.39	2.80	2.24
2	3600	6.44	5.60	3.39	2.80	2.24
	1800	7.36	6.40	3.87	3.20	2.56
	1200	7.87	6.84	4.14	3.42	2.74
	900	9.09	7.90	4.77	3.95	3.16
3	3600	9.59	8.34	5.02	4.17	3.34
	1800	10.8	9.40	5.70	4.70	3.76
	1200	11.7	10.2	6.20	5.12	4.10
	900	13.1	11.4	6.90	5.70	4.55
5	3600	15.5	13.5	8.20	6.76	5.41
	1800	16.6	14.4	8.74	7.21	5.78
	1200	18.2	15.8	9.59	7.91	6.32
	900	18.3	15.9	9.60	7.92	6.33
7-1/2	3600	22.4	19.5	11.8	9.79	7.81
	1800	24.7	21.5	13.0	10.7	8.55
	1200	25.1	21.8	13.2	10.9	8.70
	900	26.5	23.0	13.9	11.5	9.19
10	3600	29.2	25.4	15.4	12.7	10.1
	1800	30.8	26.8	16.3	13.4	10.7
	1200	32.2	28.0	16.9	14.0	11.2
	900	35.1	30.5	18.5	15.2	12.2

**Note**

① 380V 50 Hz.

### Ampere Ratings of Three-Phase, 60 Hz, AC Induction Motor, continued

hp	Syn. Speed RPM	Current in Amperes				
		200V	230V	380V ①	460V	575V
15	3600	41.9	36.4	22.0	18.2	14.5
	1800	45.1	39.2	23.7	19.6	15.7
	1200	47.6	41.4	25.0	20.7	16.5
	900	51.2	44.5	26.9	22.2	17.8
20	3600	58.0	50.4	30.5	25.2	20.1
	1800	58.9	51.2	31.0	25.6	20.5
	1200	60.7	52.8	31.9	26.4	21.1
	900	63.1	54.9	33.2	27.4	21.9
25	3600	69.9	60.8	36.8	30.4	24.3
	1800	74.5	64.8	39.2	32.4	25.9
	1200	75.4	65.6	39.6	32.8	26.2
	900	77.4	67.3	40.7	33.7	27.0
30	3600	84.8	73.7	44.4	36.8	29.4
	1800	86.9	75.6	45.7	37.8	30.2
	1200	90.6	78.8	47.6	39.4	31.5
	900	94.1	81.8	49.5	40.9	32.7
40	3600	111	96.4	58.2	48.2	38.5
	1800	116	101	61.0	50.4	40.3
	1200	117	102	61.2	50.6	40.4
	900	121	105	63.2	52.2	41.7
50	3600	138	120	72.9	60.1	48.2
	1800	143	124	75.2	62.2	49.7
	1200	145	126	76.2	63.0	50.4
	900	150	130	78.5	65.0	52.0
60	3600	164	143	86.8	71.7	57.3
	1800	171	140	90.0	74.5	59.4
	1200	173	150	91.0	75.0	60.0
	900	177	154	93.1	77.0	61.5

hp	Syn. Speed RPM	Current in Amperes				
		200V	230V	380V ①	460V	575V
75	3600	206	179	108	89.6	71.7
	1800	210	183	111	91.6	73.2
	1200	212	184	112	92.0	73.5
	900	222	193	117	96.5	77.5
100	3600	266	231	140	115	92.2
	1800	271	236	144	118	94.8
	1200	275	239	145	120	95.6
	900	290	252	153	126	101
125	3600	—	292	176	146	116
	1800	—	293	177	147	117
	1200	—	298	180	149	119
	900	—	305	186	153	122
150	3600	—	343	208	171	137
	1800	—	348	210	174	139
	1200	—	350	210	174	139
	900	—	365	211	183	146
200	3600	—	452	257	226	181
	1800	—	458	265	229	184
	1200	—	460	266	230	184
	900	—	482	279	241	193
250	3600	—	559	338	279	223
	1800	—	568	343	284	227
	1200	—	573	345	287	229
	900	—	600	347	300	240
300	1800	—	678	392	339	271
	1200	—	684	395	342	274
400	1800	—	896	518	448	358
500	1800	—	1110	642	555	444

#### Single-Phase AC Motors

The following values of full-load currents are for motors running at usual speeds and motors with normal torque characteristics. Motors built for especially low speeds or high torques may have higher full-load currents and multispeed motors will have full-load current varying with speed, in which case the nameplate current ratings shall be used.

The voltages listed are rated motor voltages. The currents listed shall be permitted for system voltage ranges of 110 to 120 and 220 to 240V.

#### Full-Load Currents in Amperes, Single-Phase Alternating-Current Motor

hp	115V	200V	208V	230V
1/6	4.4	2.5	2.4	2.2
1/4	5.8	3.3	3.2	2.9
1/3	7.2	4.1	4.0	3.6
1/2	9.8	5.6	5.4	4.9
3/4	13.8	7.9	7.6	6.9
1	16	9.2	8.8	8
1-1/2	20	11.5	11	10
2	24	13.8	13.2	12
3	34	19.6	18.7	17
5	56	32.2	30.8	28
7-1/2	80	46	44	40
10	100	57.5	55	50

#### Note

① 380V 50 Hz.

**Three-Phase AC Motors**

The following values of full-load currents are typical for motors running at speeds usual for belted motors and motors with normal torque characteristics.

Motors built for low speeds (1,200 RPM or less) or high torques may require more running current and multi-speed motors will have full-load current varying with speed. In these cases the nameplate current rating shall be used.

The voltages listed are rated motor voltages. The currents listed shall be permitted for system voltage ranges of 110 to 120, 220 to 240, 440 to 480 and 550 to 600V.

**Full-Load Current Three-Phase Alternating-Current Motors**

hp	Induction Type Squirrel Cage and Wound-Rotor Amperes						Synchronous Type Unity Power Factor <sup>①</sup> Amperes		
	115V	200V	208V	230V	460V	575V	230V	460V	575V
1/2	4.4	2.5	2.4	2.2	1.1	.9	—	—	—
3/4	6.4	3.7	3.5	3.2	1.6	1.3	—	—	—
1	8.4	4.8	4.6	4.2	2.1	1.7	—	—	—
1-1/2	12.0	6.9	6.6	6.0	3.0	2.4	—	—	—
2	13.6	7.8	7.5	6.8	3.4	2.7	—	—	—
3	—	11.0	10.6	9.6	4.8	3.9	—	—	—
5	—	17.5	16.7	15.2	7.6	6.1	—	—	—
7-1/2	—	25.3	24.2	22	11	9	—	—	—
10	—	32.2	30.8	28	14	11	—	—	—
15	—	48.3	46.2	42	21	17	—	—	—
20	—	62.1	59.4	54	27	22	—	—	—
25	—	78.2	74.8	68	34	27	53	26	21
30	—	92	88	80	40	32	63	32	26
40	—	120	114	104	52	41	83	41	33
50	—	150	143	130	65	52	104	52	42
60	—	177	169	154	77	62	123	61	49
75	—	221	211	192	96	77	155	78	62
100	—	285	273	248	124	99	202	101	81
125	—	359	343	312	156	125	253	126	101
150	—	414	396	360	180	144	302	151	121
200	—	552	528	480	240	192	400	201	161
250	—	—	—	—	302	242	—	—	—
300	—	—	—	—	361	289	—	—	—
350	—	—	—	—	414	336	—	—	—
400	—	—	—	—	477	382	—	—	—
450	—	—	—	—	515	412	—	—	—
500	—	—	—	—	590	472	—	—	—

**Note**

① For 90 and 80 percent power factor, the above figures shall be multiplied by 1.1 and 1.25 respectively.

## 1

**DC Motors**

The following values of full-load currents are for motors running at base speed.

**Full-Load Current in Amperes, Direct-Current Motors**

hp	Armature Voltage Rating <sup>①</sup>		Ampere Capacity of Fuses for Motors Recommended Values	
	120V	240V	120V	240V
1/4	3.1	1.6	5	3
1/3	4.1	2.0	5	3
1/2	5.4	2.7	7	3
3/4	7.6	3.8	10	5
1	9.5	4.7	15	7
1-1/2	13.2	6.6	20	10
2	17	8.5	25	12
3	25	12.2	30	15
5	40	20	50	25
7-1/2	58	29	80	40
10	76	38	100	50
15	—	55	—	75
20	—	72	—	100
25	—	89	—	125
30	—	106	—	150
40	—	140	—	200
50	—	173	—	250
60	—	206	—	275
75	—	255	—	350
100	—	341	—	500
125	—	425	—	600
150	—	506	—	—
200	—	675	—	—

**Note**

<sup>①</sup> These are average direct-current quantities.



**Ampacities of Insulated Conductors (Based on 2005 NEC)****Table 310.16. Allowable Ampacities of Insulated Conductors Rated 0–2000V, 60°–90°C [140°–194°F], Not More Than Three Current-Carrying Conductors in Raceway or Cable or Earth (Directly Buried), Based on Ambient Temperature of 30°C [86°F] ①**

Temperature Rating of Conductor. See NEC Table 310-13.				Aluminum or Copper-Clad Aluminum			
Copper				Aluminum or Copper-Clad Aluminum			
Size	60°C [140°F]	75°C [167°F]	90°C [194°F]	60°C [140°F]	75°C [167°F]	90°C [194°F]	Size
	Types TW†, UF ②	Types FEPW ②, RH ②, RHW ②, THHW ②, THW ②, THWN ②, XHHW ②, USE ②, ZW ②	Types TBS, SA, SIS, FEP ②, FEPB ②, MI, RHH ②, RHW-2, THHN ②, THHW ②, THW-2 ②, THWN-2 ②, USE-2, XHH, XHHW ②, XHHW-2, ZW-2	Types TW ②, UF ②	Types RH ②, RHW ②, THHW ②, THW ②, THWN ②, XHHW ②, USE ②	Types TBS, SA, SIS, THHN ②, THHW ②, THW-2, THWN-2, RHH ②, RHW-2, USE-2, XHH, XHHW, XHHW-2, ZW-2	
18	—	—	14	—	—	—	—
16	—	—	18	—	—	—	—
14	20†	20†	25†	—	—	—	—
12	25†	25†	30†	20†	20†	25†	12
10	30	35†	40†	25	30†	35†	10
8	40	50	55	30	40	45	8
6	55	65	75	40	50	60	6
70	85	95	55	65	75	4	70
85	100	110	65	75	85	3	85
95	115	130	75	90	100	2	95
110	130	150	85	100	115	1	110
1/0	125	150	170	100	120	135	1/0
2/0	145	175	195	115	135	150	2/0
3/0	165	200	225	130	155	175	3/0
4/0	195	230	260	150	180	205	4/0
250	215	255	290	170	205	230	250
300	240	285	320	190	230	255	300
350	260	310	350	210	250	280	350
400	280	335	380	225	270	305	400
500	320	380	430	260	310	350	500
600	355	420	475	285	340	385	600
700	385	460	520	310	375	420	700
750	400	475	535	320	385	435	750
800	410	490	555	330	395	450	800
600	355	420	475	285	340	385	600
700	385	460	520	310	375	420	700
750	400	475	535	320	385	435	750
800	410	490	555	330	395	450	800
900	435	520	585	355	425	480	900
1000	455	545	615	375	445	500	1000
1250	495	590	665	405	485	545	1250
1500	520	625	705	435	520	585	1500
1750	545	650	735	455	545	615	1750
2000	560	665	750	470	560	630	2000

**Notes**

① Reprinted by permission from NFPA 70-2005. National Electrical Code®, Copyright© 2005. National Fire Protection Association, Batterymarch Park, Quincy, MA 02269.

② Unless otherwise specifically permitted elsewhere in this Code, the overcurrent protection for conductor types marked with an obelisk (†) shall not exceed 15A for No. 14, 20A for No. 12 and 30A for No. 10 copper; or 15A for No. 12 and 25A for No. 10 aluminum and copper-clad aluminum after any correction factors for ambient temperature and number of conductors have been applied.

**Table 310.16. Allowable Ampacities of Insulated Conductors Rated 0–2000V, 60°–90°C [140°–194°F], Not More Than Three Current-Carrying Conductors in Raceway or Cable or Earth (Directly Buried), Based on Ambient Temperature of 30°C [86°F]—Correction Factors ①**

Temperature Rating of Conductor. See NEC Table 310-13.				Aluminum or Copper-Clad Aluminum			
Copper				Aluminum or Copper-Clad Aluminum			
Size	60°C [140°F]	75°C [167°F]	90°C [194°F]	60°C [140°F]	75°C [167°F]	90°C [194°F]	Size
	Types	Types	Types	Types	Types	Types	
AWG	FEPW ②, RH ②, RHW ②, THHW ②, THW ②, THWN ②, XHHW ②, USE ②, ZW ②	TBS, SA, SIS, FEP ②, FEPB ②, MI, RHH ②, RHW-2, THHN ②, THHW ②, THW-2 ②, THWN-2 ②, USE-2, XHH, XHHW ②, XHHW-2, ZW-2		RH ②, RHW ②, THHW ②, THW ②, THWN ②, XHHW ②, USE ②	TBS, SA, SIS, THHN ②, THHW ②, THW-2, THWN-2, RHH ②, RHW-2, USE-2, XHH, XHHW, XHHW-2, ZW-2		AWG
kcmil							kcmil
Ambient Temp. °C	For Ambient Temperatures Other Than 30°C [86°F], Multiply the Allowable Ampacities Shown in the Table on Page V5-T1-249 by the Appropriate Factor Shown Below			For Ambient Temperatures Other Than 30°C [86°F], Multiply the Allowable Ampacities Shown in the Table on Page V5-T1-249 by the Appropriate Factor Shown Below			Ambient Temp. °F
21–25	1.08	1.05	1.04	1.08	1.05	1.04	70–77
26–30	1.00	1.00	1.00	1.00	1.00	1.00	78–86
31–35	0.91	0.94	0.96	0.91	0.94	0.96	87–95
36–40	0.82	0.88	0.91	0.82	0.88	0.91	96–104
41–45	0.71	0.82	0.87	0.71	0.82	0.87	105–113
46–50	0.58	0.75	0.82	0.58	0.75	0.82	114–122
51–55	0.41	0.67	0.76	0.41	0.67	0.76	123–131
56–60	—	0.58	0.71	—	0.58	0.71	132–140
61–70	—	0.33	0.58	—	0.33	0.58	141–158
71–80	—	—	0.41	—	—	0.41	159–176

Where the number of current-carrying conductors in a raceway or cable exceeds three, the allowable ampacities shall be reduced as shown in the following table:

**Table 310.15 (B)(2)(a). Adjustment Factor for More Than Three Current-Carrying Conductors in Raceway or Cable**

Number of Current-Carrying Conductors	Percent of Values in Tables as Adjusted for Ambient Temperature if Necessary
4–6	80
7–9	70
10–20	50
21–30	45
31–40	40
41 and above	35

Where single conductors or multiconductor cables are stacked or bundled longer than 24 in (610 mm) without maintaining spacing and are not installed in raceways, the allowable ampacity of each conductor shall be reduced as shown in the above table.

**Notes**

- ① Reprinted by permission from NFPA 70-2005. National Electrical Code®, Copyright© 2005. National Fire Protection Association, Batterymarch Park, Quincy, MA 02269.
- ② Unless otherwise specifically permitted elsewhere in this Code, the overcurrent protection for conductor types marked with an obelisk (†) shall not exceed 15A for No. 14, 20A for No. 12 and 30A for No. 10 copper; or 15A for No. 12 and 25A for No. 10 aluminum and copper-clad aluminum after any correction factors for ambient temperature and number of conductors have been applied.

**Table 310.18.** Allowable Ampacities of Three Single Insulated Conductors Rated 0–2000V, 150°–250°C [302°–482°F], in Raceway or Cable Based on Ambient Air Temperature of 40°C [104°F] ①

Temperature Rating of Conductor. See NEC Table 310-13.					
Size	150°C [302°F]	200°C [392°F]	250°C [482°F]	150°C [302°F]	Size
AWG kcmil	Type Z Copper	Types FEP, FEPB, PFA	Types PFAH, TFE Nickel or Nickel-Coated Copper	Type Z Aluminum or Copper-Clad Aluminum	AWG kcmil
14	34	36	39	—	14
12	43	45	54	30	12
10	55	60	73	44	10
8	76	83	93	57	8
6	96	110	117	75	6
4	120	125	148	94	4
3	143	152	166	109	3
2	160	171	191	124	2
1	186	197	215	145	1
1/0	215	229	244	169	1/0
2/0	251	260	273	198	2/0
3/0	288	297	308	227	3/0
4/0	332	346	361	260	4/0
250	—	—	—	—	250
300	—	—	—	—	300
350	—	—	—	—	350
400	—	—	—	—	400
500	—	—	—	—	500
600	—	—	—	—	600
700	—	—	—	—	700
750	—	—	—	—	750
800	—	—	—	—	800
1000	—	—	—	—	1000
1500	—	—	—	—	1500
2000	—	—	—	—	2000

**Correction Factors**

Ambient Temp. °C	For Ambient Temperatures Other Than 40°C [104°F], Multiply the Allowable Ampacities Shown Above By the Appropriate Factor Shown Below				Ambient Temp. °F
41–50	0.95	0.97	0.98	0.95	105–122
51–60	0.90	0.94	0.95	0.90	123–140
61–70	0.85	0.90	0.93	0.85	141–158
71–80	0.80	0.87	0.90	0.80	159–176
81–90	0.74	0.83	0.87	0.74	177–194
91–100	0.67	0.79	0.85	0.67	195–212
101–120	0.52	0.71	0.79	0.52	213–248
121–140	0.30	0.61	0.72	0.30	249–284
141–160	—	0.50	0.65	—	285–320
161–180	—	0.35	0.58	—	321–356
181–200	—	—	0.49	—	357–392
201–225	—	—	0.35	—	393–437

**Note**

① Reprinted by permission from NFPA 70-2005. National Electrical Code®, Copyright© 2005. National Fire Protection Association, Batterymarch Park, Quincy, MA 02269.