

# Universal Device Mount Covers

## Single Gang

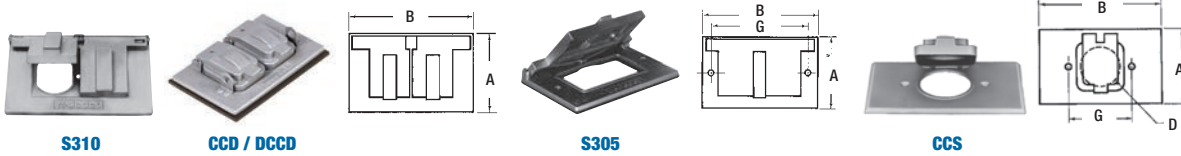

Cat. No.	Description	A (in.)	B (in.)	D (in.)	G (in.)
<b>Single Gang Device Mount Covers – Horizontal (zinc)</b>					
<b>S310BRE</b>	For duplex receptacle – Bronze	2-27/32	4-9/16	-	-
<b>S310E</b>	For duplex receptacle – Silver				
<b>S310WHE</b>	For duplex receptacle – White				
<b>CCD-L</b>	For duplex receptacle with Lock Option				
<b>DCCDSO</b>	For duplex receptacle with Lock Option Stay open – Silver				
<b>DCCDP</b>	For duplex receptacle with Lock Option Stay open – Plastic – Silver				
<b>S305BRE</b>	For GFCI receptacle – Bronze	2-13/16		1-1/2	3-13/16
<b>S305E</b>	For GFCI receptacle – Silver				
<b>S305WHE</b>	For GFCI receptacle – White				
<b>CCS</b>	For single receptacle				

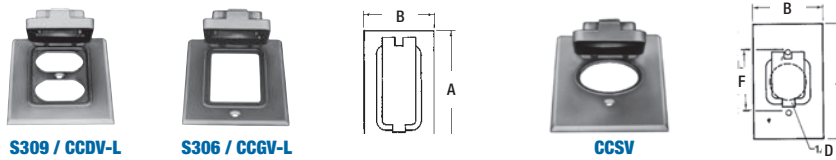

Cat. No.	Description	A (in.)	B (in.)	D (in.)	F (in.)
<b>Single Gang Device Mount Covers – Vertical (zinc)</b>					
<b>S309BRE</b>	For duplex receptacle – Bronze	4-9/16	2-13/16	-	-
<b>S309E</b>	For duplex receptacle – Silver				
<b>S309WHE</b>	For duplex receptacle – White				
<b>CCDV-L</b>	For duplex receptacle with Lock Option				
<b>S306BRE</b>	For GFCI receptacle – Bronze				
<b>S306E</b>	For GFCI receptacle – Silver				
<b>S306WHE</b>	For GFCI receptacle – White				
<b>CCGV-L</b>	For GFCI receptacle with Lock Option				
<b>CCSV</b>	For single receptacle	1-1/2	2-3/8		

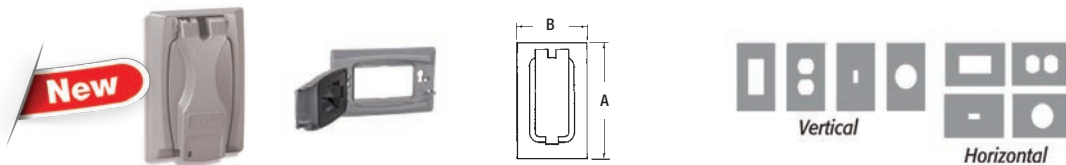

Cat. No.	Description	A (in.)	B (in.)
<b>Single Gang Device Mount Cover – Horizontal and Vertical (zinc)</b>			
<b>CCU'</b>	Flip-lid cover - silver for GFCI, single, duplex or switch configuration supplied with 2 adapters and 2 screws, lockable	4-9/16	2-13/16

Raintight with cover closed and when used with appropriate Red Dot® boxes

† Lock not included

## Universal Device Mount Covers

### Single Gang



S340E

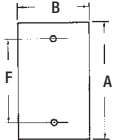

CCMB

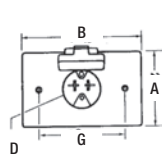

CCPO

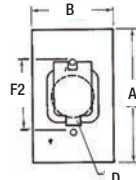

S321E / CCT-1 / SW20-2

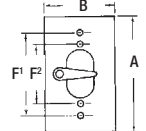

Cat. No.	Description	A (in.)	B (in.)	F (in.)
<b>Single Gang Device Mount Covers (zinc)</b>				
S340E	Blank Cover (Stamped aluminum) – Silver	4-9/16	2-13/16	3-9/32
S340BRE	Blank Cover (Stamped aluminum) – Bronze			
S340WHE	Blank Cover (Stamped aluminum) – White			



Cat. No.	Description	A (in.)	B (in.)	D (in.)	F1 (in.)	F2 (in.)	G (in.)
<b>Single Gang Device Mount Covers (zinc)</b>							
CCMB	Motor Base Cover with 15A, 125V plug	2-3/8	4-9/16	1-35/64	-	-	3-9/32
CCPO	Power outlet cover for 30A and 50A receptacles Box Mount	4-9/16	2-13/16	2-5/32	3-9/32	2-3/8	-
S321E	For switch packed with spacers						
CCT-1	Switch cover with single pole switch 15A, 125V AC						
CCT-1-20	Switch cover with single pole 20A switch, 120V, 277V AC						
SW20-2	Switch cover with double pole 20A switch, 120V, 277V AC (all with spacers and screws)						

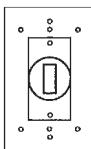

CCK

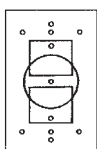

CCSK / S620E



Cat. No.	Description
<b>Single Gang Gaskets</b>	
CCK	Neoprene Gasket
CCSK	Neoprene Gasket
S620E	Neoprene Gasket

## Universal Device Mount Covers

### Two and Three Gang

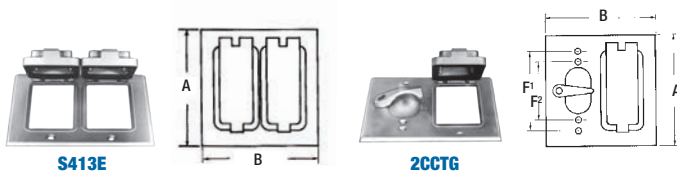

Cat. No.	Description	A (in.)	B (in.)	F1 (in.)	F2 (in.)
<b>Two and Three Gang Device Mount Covers (zinc)</b>					
S413E*	For two GFCI receptacles	4-9/16	4-5/8	—	—
2CCTG*	For switch and GFCI receptacle with spacers			3-9/32	2-3/8

\*Raintight with cover closed and when used with appropriate Red Dot® boxes

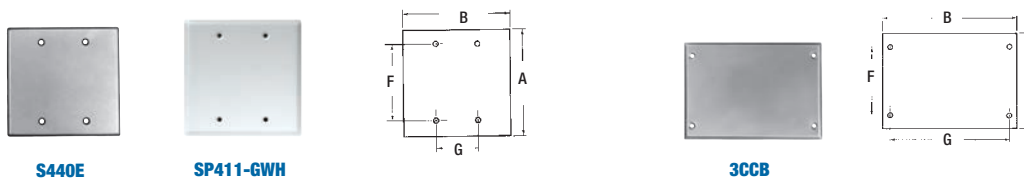

Cat. No.	Description	A (in.)	B (in.)	F (in.)	G (in.)
<b>Two and Three Gang Device Mount Covers (Stamped Aluminum)</b>					
S440E	Blank Cover, Two Gang	4-9/16	4-5/8	3-9/32	1-13/16
SP411-GWH	Blank Cover, Two Gang (Stamped Aluminum) - White	4-1/2	6-3/8	3-1/4	5-5/8
3CCB	Blank Cover, Three Gang	4-9/16	4-5/8	3-9/32	1-13/16



Cat. No.	Colour	Description	A (in.)	B (in.)
<b>Two Gang Covers (zinc)</b>				
2CCU	Silver	Flip-lid cover for GFCI, duplex or single switch configurations supplied with 4 adapters and 4 screws lockable (lock not included)	4-9/16	4-5/8
2CCU-BR	Bronze			
2CCU-WH	White			

## Universal Device Mount Covers

### Two Gang

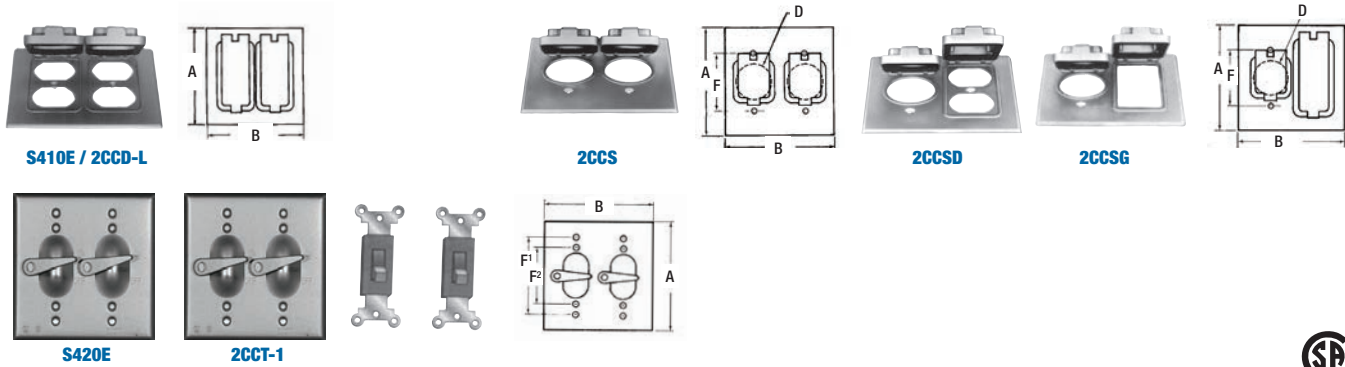

Cat. No.	Description	A (in.)	B (in.)	D (in.)	F (in.)	F1 (in.)	F2 (in.)
<b>Two Gang Device Mount Covers (zinc)</b>							
<b>S410E*</b>	For two duplex receptacles	4-9/16	4-5/8	-	-	-	-
<b>2CCD-L*</b>	For two duplex receptacles with Lock Option (lock not included)						
<b>2CCS*</b>	For two single receptacles						
<b>2CCSD*</b>	For single and duplex receptacles			1-31/64	2-3/8		
<b>2CCSD-L*</b>	For single and duplex receptacles with Lock Option (lock not included)						
<b>2CCSG*</b>	For single and GFCI receptacles						
<b>S420E*</b>	For two switches with spacers			-	-		
<b>2CCT-1*</b>	Switch cover with two single pole switches 15A, 125V AC						

\*Raintight with cover closed and when used with appropriate Red Dot® boxes