



**Ring Terminal  
T&B Catalog Number:**

E6-38  
78621080359  
Active

**UPC Number:  
Status:  
Description:**

Non-Insulated - Brazed Seam Ring Terminal For Wire Range 6 Stud Size 3/8, Metallic

**WEB\_USE**

US Cutsheet PDF Catalog Link <http://www-public.tnb.com/contractor/docs/stakon.pdf>

**Features**

These non-insulated ring terminals are made of electrolytic copper for high conductivity. They can be installed with crimping tools having a single indenter or double indenter (recommended for solid wire). Serrated barrel increases grip on wire.

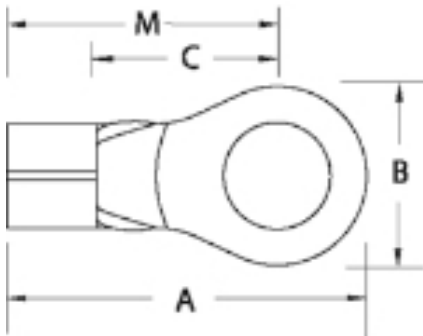

**General**

Insulation Type	Non-Insulated - Brazed Seam
Terminal Series	E
Material	Copper
Finish	Electro -Tin Plated
Color	Metallic
Wire Range	6
Stud Size	3/8

**Dimension Information**

Stock Thickness	.06
A (inches)	1.32
B (inches)	.60
C (inches)	.49
M (inches)	1.03

**Specifications**

Temperature Rating	150°C
Voltage Rating	600V
Flammability Rating	UL 94 V-0

**Tooling**

Tool Charts	Available on Website
Application Tools	WT115A, TBM6, TBM6S, WT3185
Recommended Tool	TBM6S

**Packaging**

T&B Order Multiple	20
T&B Inner Pack	20
Package in Units	100
Package Type	Standard
T&B Sold in UOM	Each
T&B Weight Per UOM	1.75 lbs. per 100
Alternate Package Qty	E73

**Application Support**

Overview	Available on Website
Wire Guide Tables	Available on Website

## Notes

Not available on Mylar Tape.

## Certifications

RoHS Compliance

Yes

## Certifications



File Nbr:

E9809

### For further technical assistance, please contact us...

Thomas & Betts - USA  
8155 T&B Blvd.  
Memphis, TN 38125  
www.tnb.com

T&B Technical Support  
MS 3B-50  
8155 T&B Blvd.  
Memphis, TN 38125

Hours: 7AM - 6PM CDT  
Monday-Friday  
Phone: (888) 862-3289  
Fax: (901) 252-1321  
Email:techsupport@tnb.com