

TERMINATION INSTRUCTIONS

STEP 1

Remove approximately 1" of cable jacket. (CAUTION: Do not damage conductors.) Fan out twisted pairs for termination.

STEP 2

Use the PDT110 Single Wire Punchdown tool to punchdown conductors in the orientation shown.

RCA Module

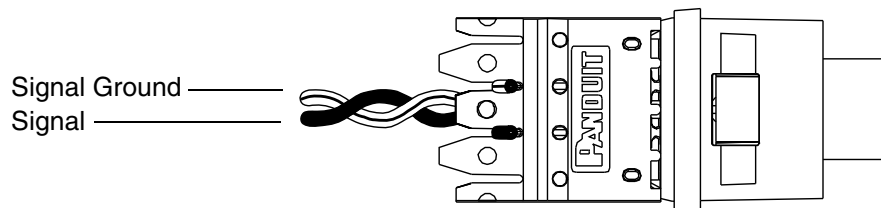

Signal and Signal Ground use one twisted pair

S-Video Module

(UTP Cable)

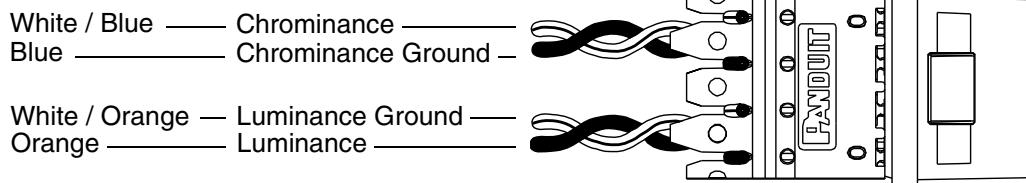

Chrominance and Chrominance Ground use one twisted pair
Luminance and Luminance Ground use one twisted pair

Modules should appear as shown below when terminated.

RCA Module

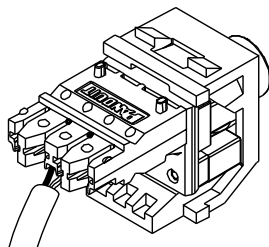

S-Video Module

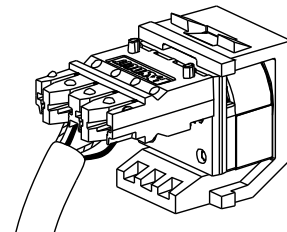

STEP 3

Install the P110RC2 wire retention cap onto the connector block.
 Modules should appear as shown below when completed.

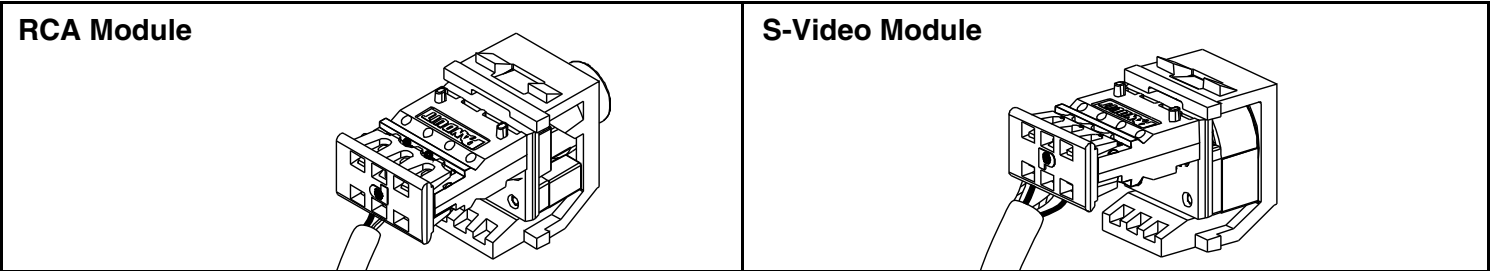

OPTIONAL STEP

Use the optional NKSPB NetKey 110PD Module Puck to align and hold the module for termination to the connector block.

Set fully assembled module into puck, aligning flexible snap on module with screwdriver slot on puck. Snap in place. Do not press on the connector to snap in place.

To remove module from puck, place index finger on the opposite side of the screwdriver slot and thumb on the NetKey housing, not on the punch-down block, otherwise module will be damaged. Apply pressure to module flexible snap, tilt module, and remove. Using a small screwdriver to remove the module is optional.

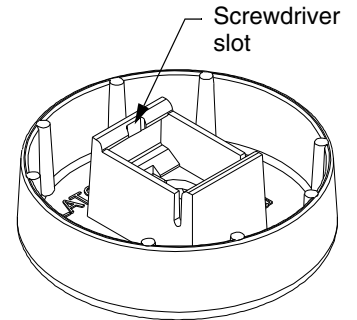

NKSPB

MODULE INSTALLATION

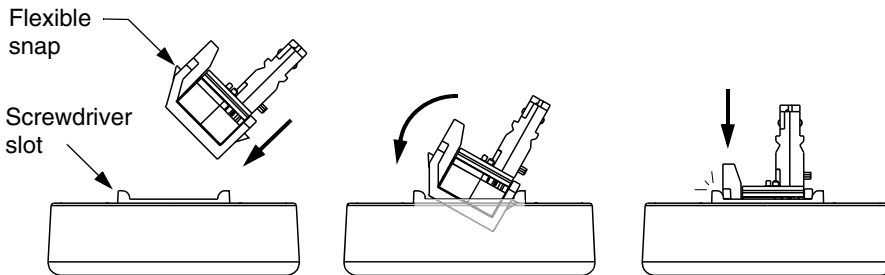

Screwdriver is optional to remove NetKey module from puck.

MODULE REMOVAL

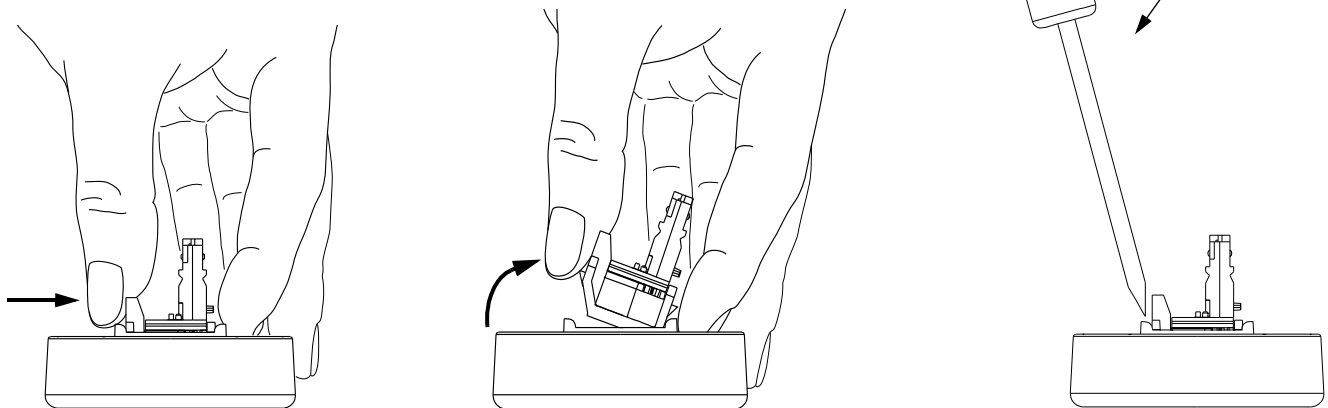

INSTALLATION TIPS:

1. Pan-Punch product terminates most 22-26 AWG solid or stranded IWC wire with a 0.050" (1.27mm) max. o.d., either PVC or plenum rated.
2. Never install wire into a slot previously used for a larger gauge.
3. Be careful to strip back cable jacket only as required for termination.
4. Use care to maintain pair twists to within 0.50 inches (13mm) of the termination strip.
5. When stripping cable jacket, be careful not to cut the insulation on the individual wires.
6. Avoid sharp bends when routing cable.

For Instructions in Local Languages
 and Technical Support:

www.panduit.com/resources/install_maintain.asp



www.panduit.com

E-mail:
techsupport@panduit.com

Phone:
 866-405-6654