

# Powertite® Series Pin and Sleeve Plugs, Connectors and Receptacles

## Applications

- Designed to supply power to portable or fixed electrical equipment such as motor generator units, welders, pumps, compressors, cellular relay stations, and similar apparatus.
- Ideal for use on shipping docks, ports, and other “ship to shore” applications.
- Suitable for use in locations where a weatherproof enclosure is required.
- Rough usage construction.

## Features

- Available in 30, 60, 100, 150, 200, and 400 Amp units.
- Available in two grounding styles: Style 1 (shell only) and Style 2 (shell and extra pole).
- Neoprene bushing compressed by cable collar prevents entrance of water. Bushing is highly resistant to hydrocarbon deterioration and is self-extinguishing.
- Locking screw and slot prevents plug cable collar from “backing off.”
- Contacts exert constant pressure along entire contact surface and provide electrical continuity.
- Suitable for use from -40 °C to 107 °C (-40 °F to 225 °F).
- Insulating blocks provide greatest dielectric and mechanical strength and lowest arc tracking.
- Positive polarization: only plugs and receptacles of same style, number of poles and ampere rating can be used together.
- Circuit breaking: in 30, 60, 100, and 200 Amp units, any arcing created as line and load terminals disengage is safely confined deep within terminal cavities. Plugs may be withdrawn in an emergency under full rated loads without separate disconnect switches (400 Amp plug is for disconnecting use only; not for current rupturing).
- 30, 60, 100, and 150 Amp Powertite® plugs also suitable for classified locations when used with Appleton EBR, EBRH, JBR, MD2SR, or DBR explosionproof interlocking receptacles.
- Controlled length contacts ensure that ground makes first and breaks last for added safety.

## Standard Materials

- Plug, receptacle, connector and mounting box housings: copperfree (4/10 of 1% max.) aluminum
- Insulating blocks: glass filled polyester

## Standard Finishes

- Aluminum plug, receptacle, connector and mounting box housings: epoxy powder coat
- Insulating blocks and contacts: natural finish

## Options

- See Illustrated Options

## NEC/CEC Certifications and Compliances

- UL Standard: UL 1682, UL 1686, UL 50E
- UL Listed: E145916, E145917
- CSA Standard: C22.2 No. 182.1
- CSA Certified: 065179
- NEMA 4X (30, 60, 100, 150, and 200 Amp)
- NEMA Configuration: FB11

## Related Products

- For classified location plugs and receptacles, see *Plugs and Receptacles: Hazardous Location*.



30 and 60 Amp



100 and 150 Amp



200 Amp

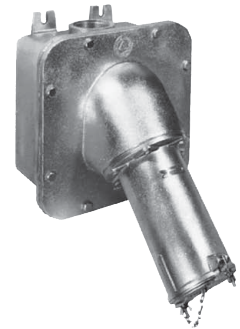

400 Amp

Classified by UL and Certified by CSA for use in specific combinations with Crouse-Hinds Arktite. Arktite is a registered trademark of Cooper Crouse-Hinds.

# Powertite® Series Pin and Sleeve Plugs, Connectors and Receptacles

## Illustrated Features

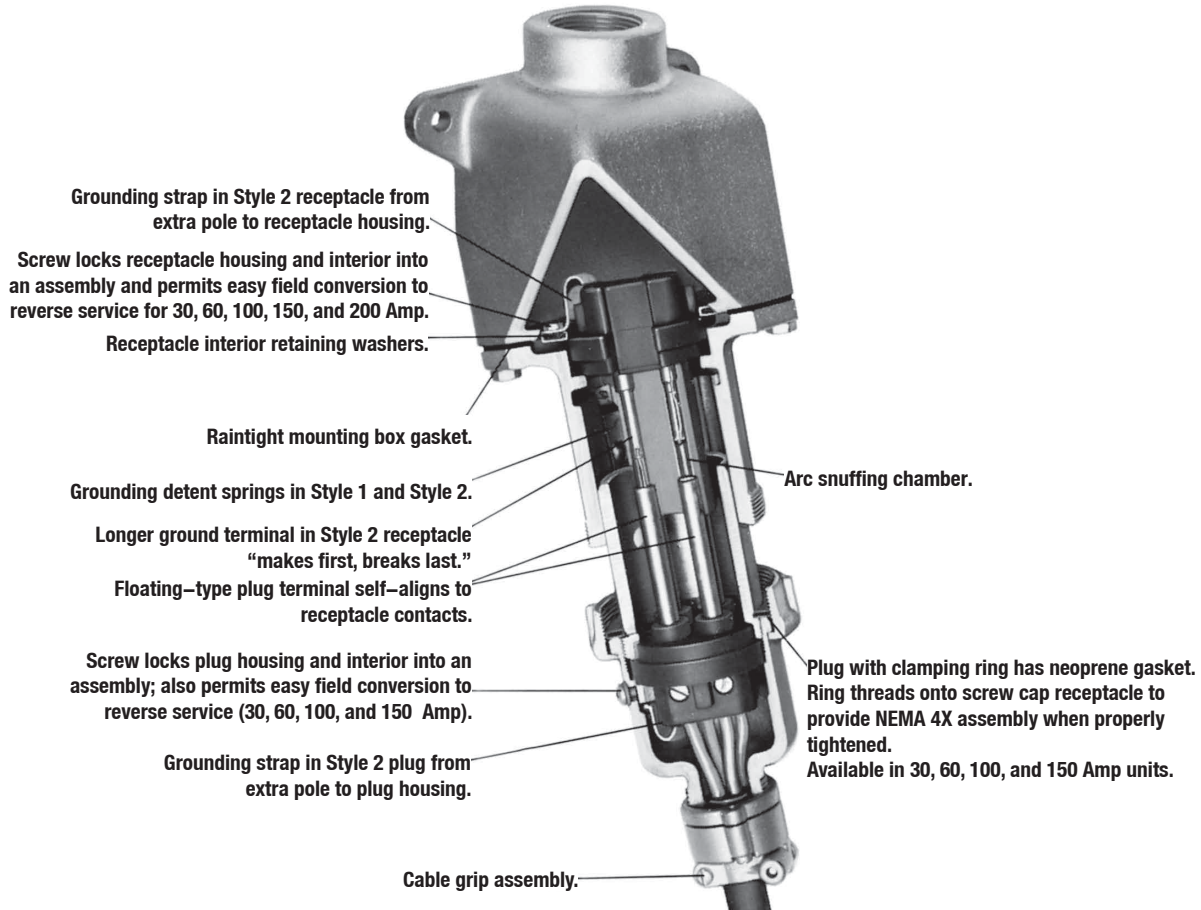

# Powertite® Series Pin and Sleeve Plugs, Connectors and Receptacles

## Illustrated Features

### Grounding Styles

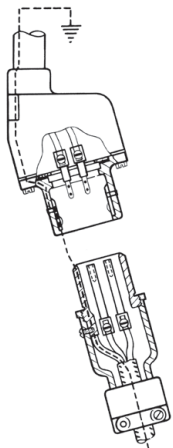

**Style 1  
(Shell Only)**

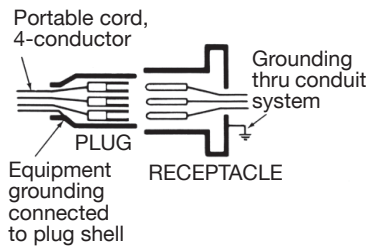

**Plug**—Equipment grounding conductor is wired directly to solderless lug which is connected to the plug housing with a pressure connector. All terminals are “current carrying.”

**Receptacle**—Two detent spring clips engage the grounded plug housing on plug insertion—grounded plug shell makes contact with receptacle ground spring before line and load poles are engaged. Grounding path is maintained until after current-carrying contacts disengage. All terminals are “current carrying.”

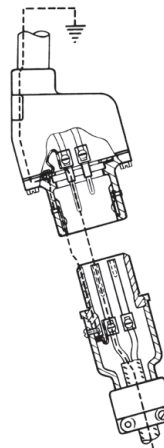

**Style 2  
(Shell and Extra Pole)**

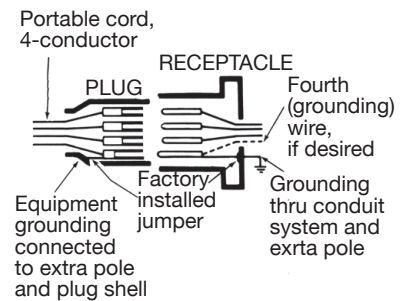

**Plug**—Equipment grounding conductor is not only connected to the solderless lug in the plug housing, but also to an extra grounding pole. Grounding pole has copper alloy grounding jumper strap that connects to plug housing.

**Receptacle**—Two detent spring clips engage grounded plug housing on plug insertion. Jumper from extra grounding pole is electrically connected to a screw on receptacle housing. Longer grounding pole “makes first and breaks last.”

### Pin and Sleeve Design ①



**30, 60, and 100 Amp Pressure Wire Terminals.  
Solid Brass Contacts with Beryllium Copper Springs.**



**150 Amp Pressure Wire Terminals.  
Solid Copper Contacts with Beryllium Copper Springs.**



**200 Amp Pressure Wire Terminals. Solid Copper Split-Type Contact.**



**400 Amp 0.84" Solder Well Wire Terminals. Solid Copper Contacts with Four Spring-Loaded Borosilicate Bearings.**



**400 Amp 1.25" Solder Wire Well Terminals. Solid Copper Contacts with Four Spring-Loaded Borosilicate Bearings.**

① Pins and sleeves are not sold separately. Available on the Replacement Interiors pages.

# Powertite® Series Pin and Sleeve Plugs, Connectors and Receptacles

## Illustrated Features

### Spring Door and Screw Cap

30, 60, 100, and 150 Amp spring door and screw cap receptacles are threaded to accept clamping ring ACP plug. The ring threads onto the receptacle to form a raintight assembly with plug in use-and also to prevent plug fallout. When the plug is withdrawn, the gasketed spring door cover closes tightly against receptacle opening automatically, providing weatherproof protection. Spring door has stainless steel spring and shaft.



### Spring Door Cover

30, 60, 100, and 150 Amp units may be located at any position in a 360° circle by adjusting a setscrew. Set screw also allows complete removal of cover. Spring door available on 200 Amp units.

*NOTE: Spring Door cover in open positions for illustration only.*



### ACP Plugs

Supplied with bushings to accommodate a wide variety of cable diameters. 30 Amp plug clamp used in first position with smallest inside diameter bushing provides positive grip on cables as small as 0.390 inches, such as those that are used in oil rig installations.



### Reversible Cable Clamps

Permits wide cable range (just loosen screws and flip over). Each position accommodates one of two bushings. Convenient in installations having different cable sizes.



## Illustrated Options

### Standard Service

Energized receptacle has recessed male contacts to reduce danger of accidental touching. Plug has female contacts that are energized only upon insertion in receptacle.

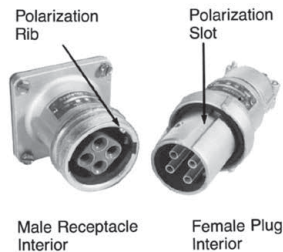

### Reverse Service (Generator Application)

Useful where a "hot" plug feeds a dead receptacle. Reverse service is often used for generator applications where the receptacle houses a dead plug interior. Plug houses an energized receptacle interior, which has recessed male contacts to reduce danger of accidental touching. 30, 60, 100, 150, and 200 Amp units can be easily converted to reverse service in the field when matching plug and receptacle are ordered. 400 Amp unit is only available as a factory assembled item at extra cost. Add suffix **-RS** to receptacle or connector.

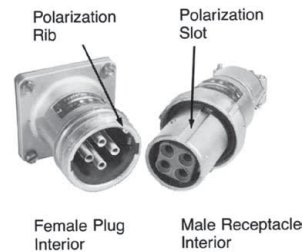

### Special Polarization

Special polarization is available on 30, 60, 100, 200, and 400 Amp units. Prevents plug insertion in a receptacle or connector wired for a different voltage. In installations where there are different line voltages, the special polarization option is desirable. This allows only plugs and receptacles wired for the same line voltage to be mated together. The receptacle or connector interior is positioned 22-1/2°, relative to the polarization rivet, to the right (as specified) of standard, and plug is polarized to correspond. Add suffix **-P4** to the standard or reverse service plug, receptacle or connector.

# Powertite® Series Pin and Sleeve Plugs, Connectors and Receptacles

## Features at a Glance

Amp	Receptacle Types					Contacts		Brass Ground Contacts	Reverse Service	
	Grounding Styles	Weatherproof Spring Door	NEMA 4X Screw Cap	Raintight Clamp Cover	Brass with Beryllium Copper Springs	Copper with Borosilicate Bearings	Split-type Copper Contacts		In Field	Factory Only
30	1 and 2	X	X		X			Style 2	X	
60	1 and 2	X	X		X			Style 2	X	
100	1 and 2	X	X		X			Style 2	X	
150	2	X	X		X ②			Style 2	X	
200	1 and 2	X ▼		X ▼			X	Style 2	X ①	
400	1 and 2					X		Style 2		X

## Application Chart

Grounding Style	Wire/Pole	Single Phase		Grounding Style	Wire/Pole	Three Phase	
		With Neutral	Without Neutral			With Neutral	Without Neutral
Style 1 (Shell Only)	2W, 2P	L1+N+G	L1+L2+G	Style 1 (Shell Only)	2W, 2P		
	3W, 3P	L1+L2+N+G			3W, 3P		L1+L2+L3+G
	4W, 4P				4W, 4P	L1+L2+L3+N+G	
Style 2 (Shell and Extra Pole)	2W, 3P	L1+N+G	L1+L2+G	Style 2 (Shell and Extra Pole)	2W, 3P		
	3W, 4P	L1+L2+N+G			3W, 4P		L1+L2+L3+G

**Powertite® Horsepower Ratings** Plug may be withdrawn in an emergency if within these maximum HP ratings. Not for normal starting/stopping.

Phase Motor	Amps	Motor Horsepower				Phase Motor	Amps	Motor Horsepower			
		115 Vac	230 Vac	480 Vac	600 Vac			115 Vac	230 Vac	480 Vac	600 Vac
<b>For Emergency Disconnect Only</b>						1-Phase	30	2	3	10	10
3-Phase	30	3	7-1/2	15	20	2W, 2P	60	3	10	20	20
3W, 3P;	60	7-1/2	15	30	30	or	100	7-1/2	15	30	30
3W, 4P;	100	10	20	40	40	2W, 3P	200	15	30	40	40
or	150	Do Not Disconnect Under Load									
4W, 4P	200	20	40	50	50						

## Range of Wire Sizes Accommodated in Powertite® Plug and Receptacle Terminals

60 °C/140 °F minimum wire ratings.

30, 60, 100, and 150 Amp				200 Amp			400 Amp		
Amps	Wire Recess Dia. (Inches)	Wire Range Building	Wire Range Extra Flex.	Wire Recess Dia. (Inches)	Conductor Size	Type Conductor	Solder Recess Dia. (Inches)	Conductor Size	Type Conductor
30	.281	#10 – #6	#10 – #8	0.687	250	General Wire	0.84	500 MCM	General Wire
60	.312	#6 – #2	#6 – #4		4/0	General Wire		400 MCM	Flex. Cable
100	.391	#4 – #1	#4 – #2		4/0	Flex. Cable		400 MCM	Extra Flex.
150	.525	#2 – 2/0	#2 – 2/0		3/0	Flex. Cable	1.25	1000 MCM	General wire
					3/0	Extra Flex.		900 MCM	General Wire
					2/0	Flex. Cable		800 MCM	Extra Flex.

▼ NEMA 4X.

① For receptacle only.

② Copper with beryllium copper springs.

# Powerlite® 30 Amp Pin and Sleeve Plugs and Receptacles

600 Vac, 250 Vdc, 50-400 Hz

Pressure Wire Terminals – Wire Recess Diameter: .281". Wire Size Range: #10—#6 Building; #10—#8 Extra Flex.

NEC/CEC:  
NEMA 3, 3R, 4, 4X

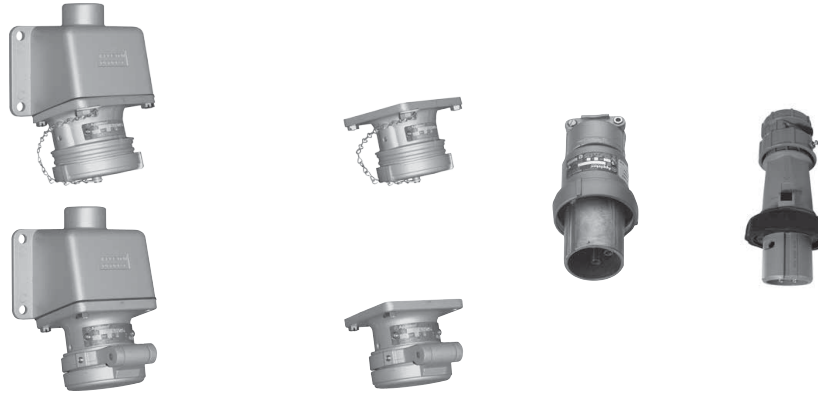

Plugs and Receptacles

NEC/CEC ORDINARY LOCATION PLUGS AND RECEPTACLES

Grounding Style	Wire/Pole	Receptacle with AEE Mounting Box ①	Hub Size (Inches)	Receptacle Only ③	Metallic Clamping Ring Plug ②	Nonmetallic Clamping Ring Plug ②	Plug Cable Dia. (Inches)
Style 1 (Shell Only)	2W, 2P	ADRE3022-50	1/2	ADR3022	ACP3022BC	—	.500 to 1.250
		ADRE3022-75	3/4				
	3W, 3P	ADRE3033-75	3/4	ADR3033	ACP3033BC	—	.500 to 1.250
		ADRE3033-100	1				
4W, 4P	ADRE3044-75	3/4	ADR3044	ACP3044BC	—	.500 to 1.250	
	ADRE3044-100	1					
Style 2 (Shell and Extra Pole)	2W, 3P	ADRE3023-75	3/4	ADR3023	ACP3023BC	—	.500 to 1.250
		ADRE3023-100	1				
	3W, 4P	ADRE3034-75	3/4	ADR3034	ACP3034BC	NMACP3034BC	.500 to 1.250
		ADRE3034-100	1				

Receptacles are provided with spring door and screw cap.  
For Reverse Service, add suffix **-RS** to Catalog Number.  
For Special Polarization, add suffix **-P4** to Catalog Number.

## Horsepower Ratings for Emergency Disconnect Under Load

Plug may be withdrawn in an emergency if within these maximum HP ratings. Not for normal starting and stopping.

Phase Motor	Wire/Pole	Motor Horsepower			
		120 Vac	240 Vac	480 Vac	600 Vac
1-Phase	2W, 2P or 2W, 3P	2HP	3HP	10HP	10HP
3-Phase	3W, 3P; 3W, 4P; or 4W, 4P	3HP	7-1/2HP	15HP	20HP

① For additional mounting boxes, see Aluminum Mounting Boxes.

② Plug and receptacle combination is NEMA 4X rated when clamping ring is fully tightened on receptacle.

③ Receptacle is NEMA 4X rated when screw cap is closed when the receptacle is not in use.



# Powertite® 30 Amp Pin and Sleeve Connectors and Plugs

600 Vac, 250 Vdc, 50-400 Hz

Pressure Wire Terminals – Wire Recess Diameter: .281". Wire Size Range: #10—#6 Building; #10—#8 Extra Flex.

NEC/CEC:  
NEMA 3, 3R, 4, 4X



Grounding Style	Wire/Pole	Connector Body Only	Metallic Clamping Ring Plug ①	Connector/Plug Cable Dia. (Inches)
Style 1 (Shell Only)	2W, 2P	ARC3022BC	ACP3022BC	.500 to 1.250
	3W, 3P	ARC3033BC	ACP3033BC	.500 to 1.250
	4W, 4P	ARC3044BC	ACP3044BC	.500 to 1.250
Style 2 (Shell and Extra Pole)	2W, 3P	ARC3023BC	ACP3023BC	.500 to 1.250
	3W, 4P	ARC3034BC	ACP3034BC	.500 to 1.250

For Reverse Service, add suffix **-RS** to Catalog Number.  
For Special Polarization, add suffix **-P4** to Catalog Number.

## Pin and Sleeve Design

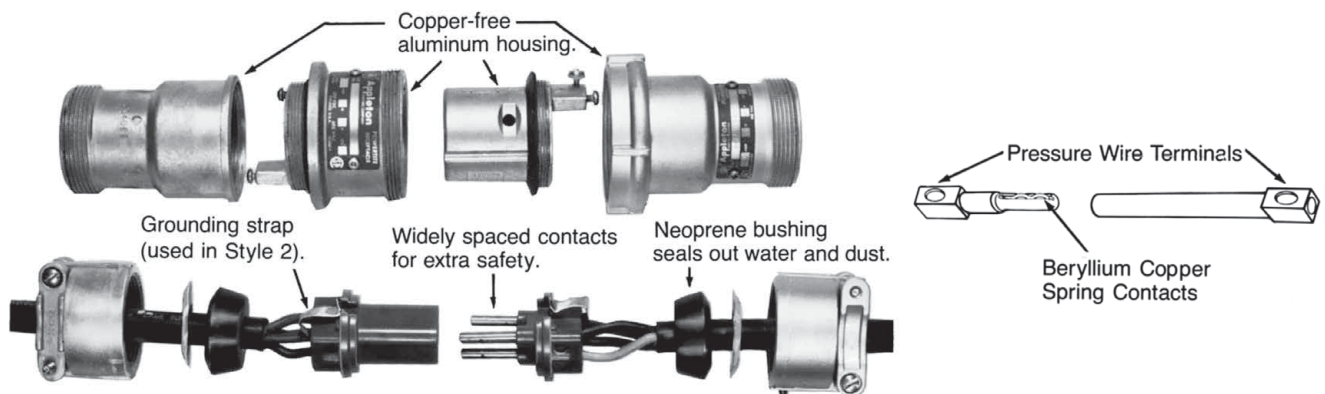

**Energized contacts** deeply recessed to reduce danger of accidental touching, minimize possibility of exposed arcs. Insulator quenches arcing, and is resistant to abnormal heat and to fire.

**Plug mechanical cable clamps** provide strain relief conductor connections, allow easy cable replacement.

**Pressure wire terminals** allow cable to be readily replaced when necessary. Terminal screws grip conductors firmly. Spring contacts provide constant pressure.

① Plug and connector body combination is NEMA 4X rated when clamping ring is fully tightened on connector body.

# Powertite® 60 Amp Pin and Sleeve Plugs and Receptacles

600 Vac, 250 Vdc, 50-400 Hz

Pressure Wire Terminals – Wire Recess Diameter: .312". Wire Size Range: #6—#2 Building; #6—#4 Extra Flex.

NEC/CEC:  
NEMA 3, 3R, 4, 4X

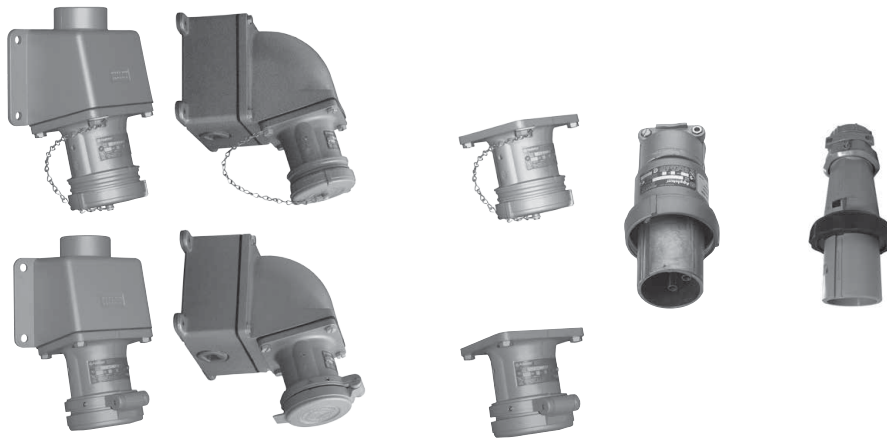

Plugs and Receptacles

NEC/CEC ORDINARY LOCATION PLUGS AND RECEPTACLES

Grounding Style	Wire/Pole	Receptacle with AEE Mounting Box ①	Receptacle with AJA Mounting Box ①	Hub Size (Inches)	Receptacle Only ③	Metallic Clamping Ring Plug ②	Nonmetallic Clamping Ring Plug ②	Plug Cable Dia. (Inches)
Style 1 (Shell Only)	2W, 2P	ADRE6022-100	ADJA6022-100	1	ADR6022	ACP6022BC	—	.500 to 1.250
		ADRE6022-125	ADJA6022-125	1-1/4				
	3W, 3P	ADRE6033-100	ADJA6033-100	1	ADR6033	ACP6033BC	—	.500 to 1.250
		ADRE6033-125	ADJA6033-125	1-1/4				
	4W, 4P	ADRE6044-125	ADJA6044-125	1-1/4	ADR6044	ACP6044BC	—	.500 to 1.250
		ADRE6044-150	ADJA6044-150	1-1/2				
Style 2 (Shell and Extra Pole)	2W, 3P	ADRE6023-100	ADJA6023-100	1	ADR6023	ACP6023BC	—	.500 to 1.250
		ADRE6023-125	ADJA6023-125	1-1/4				
	3W, 4P	ADRE6034-125	ADJA6034-125	1-1/4	ADR6034	ACP6034BC	NMACP6034BC	.500 to 1.250
		ADRE6034-150	ADJA6034-150	1-1/2				

Receptacles are provided with spring door and screw cap.  
For Reverse Service, add suffix **-RS** to Catalog Number.  
For Special Polarization, add suffix **-P4** to Catalog Number.

## Horsepower Ratings for Emergency Disconnect Under Load

Plug may be withdrawn in an emergency if within these maximum HP ratings. Not for normal starting and stopping.

Phase Motor	Wire/Pole	120 Vac	240 Vac	480 Vac	600 Vac
1-Phase	2W, 2P or 2W, 3P	3HP	10HP	20HP	20HP
3-Phase	3W, 3P; 3W, 4P; or 4W, 4P	7-1/2HP	15HP	30HP	30HP

① For additional mounting boxes, see Aluminum Mounting Boxes.

② Plug and receptacle combination is NEMA 4X rated when clamping ring is fully tightened on receptacle.

③ Receptacle is NEMA 4X rated when screw cap is closed when the receptacle is not in use.



# Powertite® 60 Amp Pin and Sleeve Connectors and Plugs

600 Vac, 250 Vdc, 50-400 Hz

Pressure Wire Terminals – Wire Recess Diameter: .312". Wire Size Range: #6—#2 Building; #6—#4 Extra Flex.

NEC/CEC:  
NEMA 3, 3R, 4, 4X



Grounding Style	Wire/Pole	Connector Body Only	Metallic Clamping Ring Plug ①	Connector/Plug Cable Dia. (Inches)
Style 1 (Shell Only)	2W, 2P	ARC6022BC	ACP6022BC	.500 to 1.250
	3W, 3P	ARC6033BC	ACP6033BC	.500 to 1.250
	4W, 4P	ARC6044BC	ACP6044BC	.500 to 1.250
Style 2 (Shell and Extra Pole)	2W, 3P	ARC6023BC	ACP6023BC	.500 to 1.250
	3W, 4P	ARC6034BC	ACP6034BC	.500 to 1.250

For Reverse Service, add suffix **-RS** to Catalog Number.  
For Special Polarization, add suffix **-P4** to Catalog Number.

## Pin and Sleeve Design

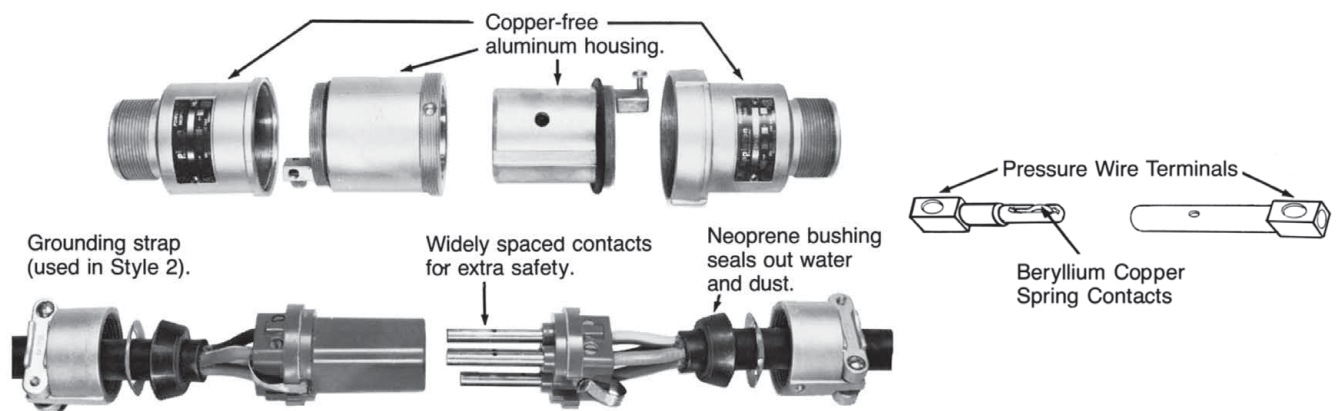

**Energized contacts** deeply recessed to reduce danger of accidental touching, minimize possibility of exposed arcs. Insulator quenches arcing, and is resistant to abnormal heat and to fire.

**Plug mechanical cable clamps** provide strain relief at conductor connections, allow easy cable replacement.

**Pressure wire terminals** allow cable to be readily replaced when necessary. Terminal screws grip conductors firmly. Spring contacts provide constant pressure.

① Plug and connector body combination is NEMA 4X rated when clamping ring is fully tightened on connector body.

# Powertite® 100 and 150 Amp Pin and Sleeve Plugs and Receptacles

600 Vac, 250 Vdc, 50-400 Hz

Pressure Wire Terminals – 100 Amp: Wire Recess Diameter: .391". Wire Size Range: #4—#1 Building; #4—#2 Extra Flex.

150 Amp: Wire Recess Diameter: .525". Wire Size Range: #2—2/0 Building; #2—#2/0 Extra Flex.

NEC/CEC:  
NEMA 3, 3R, 4, 4X

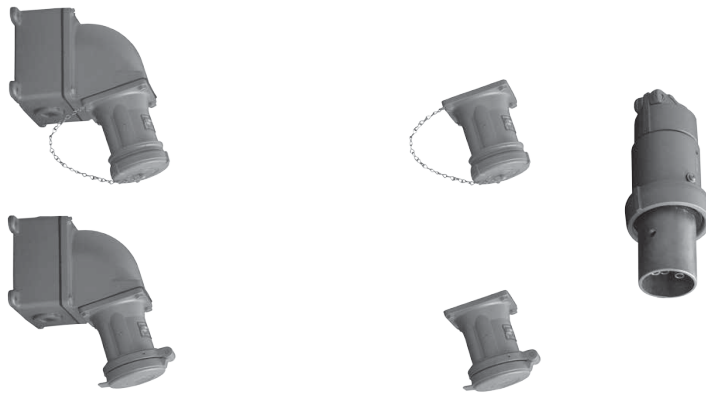

Plugs and Receptacles

NEC/CEC ORDINARY LOCATION PLUGS AND RECEPTACLES

Grounding Style	Wire/Pole	Receptacle with AJA Mounting Box ①	Hub Size (Inches)	Receptacle Only ③	Clamping Ring Plug ②	Plug Cable Dia. (Inches)
100 Amp Style 1 (Shell Only)	2W, 2P	ADJA1022-125	1-1/4	ADR1022	ACP1022CD	.875 to 1.906
		ADJA1022-150	1-1/2			
	3W, 3P	ADJA1033-125	1-1/4	ADR1033	ACP1033CD	.875 to 1.906
		ADJA1033-150	1-1/2			
	4W, 4P	ADJA1044-150	1-1/2	ADR1044	ACP1044CD	.875 to 1.906
		ADJA1044-200	2			
100 Amp Style 2 (Shell and Extra Pole)	2W, 3P	ADJA1023-125	1-1/4	ADR1023	ACP1023CD	.875 to 1.906
		ADJA1023-150	1-1/2			
	3W, 4P	ADJA1034-150	1-1/2	ADR1034	ACP1034CD	.875 to 1.906
		ADJA1034-200	2			
150 Amp Style 2 (Shell and Extra Pole)	3W, 4P	ADJA15034-150	1-1/2	ADR15034	ACP15034CD	.875 to 1.906
		ADJA15034-200	2			

Receptacles are provided with spring door and screw cap.

For Reverse Service, add suffix **-RS** to Catalog Number.

For Special Polarization for 100 amp units, add suffix **-P4** to Catalog Number. (Not available for 150 Amp units.)

## Horsepower Ratings for Emergency Disconnect Under Load

Not for normal starting and stopping, but plug may be withdrawn in an emergency if within these maximum HP ratings.

Amp	Motor Phase	Wire/Pole	Motor Horsepower			
			120 Vac	240 Vac	480 Vac	600 Vac
100	1-Phase	2W, 2P or 2W, 3P	7-1/2HP	15HP	30HP	30HP
	3-Phase	3W, 3P; 3W, 4P; or 4W, 4P	10HP	20HP	40HP	40HP
150	3-Phase	3W, 4P	Do Not Disconnect Under Load			

① For additional mounting boxes, see Aluminum Mounting Boxes.

② Plug and receptacle combination is NEMA 4X rated when clamping ring is fully tightened on receptacle.

③ Receptacle is NEMA 4X rated when screw cap is closed when the receptacle is not in use.

# Powertite® 100 and 150 Amp Pin and Sleeve Connectors and Plugs

600 Vac, 250 Vdc, 50-400 Hz

Pressure Wire Terminals – 100 Amp: Wire Recess Diameter: .391". Wire Size Range: #4—#1 Building; #4—#2 Extra Flex.

150 Amp: Wire Recess Diameter: .525". Wire Size Range: #2—2/0 Building; #2—#2/0 Extra Flex.

NEC/CEC:  
NEMA 3, 3R, 4, 4X



Grounding Style	Wire/Pole	Connector Body Only	Clamping Ring Plug ①	Connector/Plug Cable Dia. (Inches)
100 Amp Style 1 (Shell Only)	2W, 2P	ARC1022CD	ACP1022CD	.875 to 1.906
	3W, 3P	ARC1033CD	ACP1033CD	.875 to 1.906
	4W, 4P	ARC1044CD	ACP1044CD	.875 to 1.906
100 Amp Style 2 (Shell and Extra Pole)	2W, 3P	ARC1023CD	ACP1023CD	.875 to 1.906
	3W, 4P	ARC1034CD	ACP1034CD	.875 to 1.906
150 Amp Style 2 (Shell and Extra Pole)	3W, 4P	ARC15034CD	ACP15034CD	.875 to 1.906
	3W, 4P	ARC15034DE	ACP15034DE	1.250 to 2.187

For Reverse Service, add suffix **-RS** to Catalog Number.

For Special Polarization for 100 amp units, add suffix **-P4** to Catalog Number. (Not available for 150 Amp units.)

## Pin and Sleeve Design

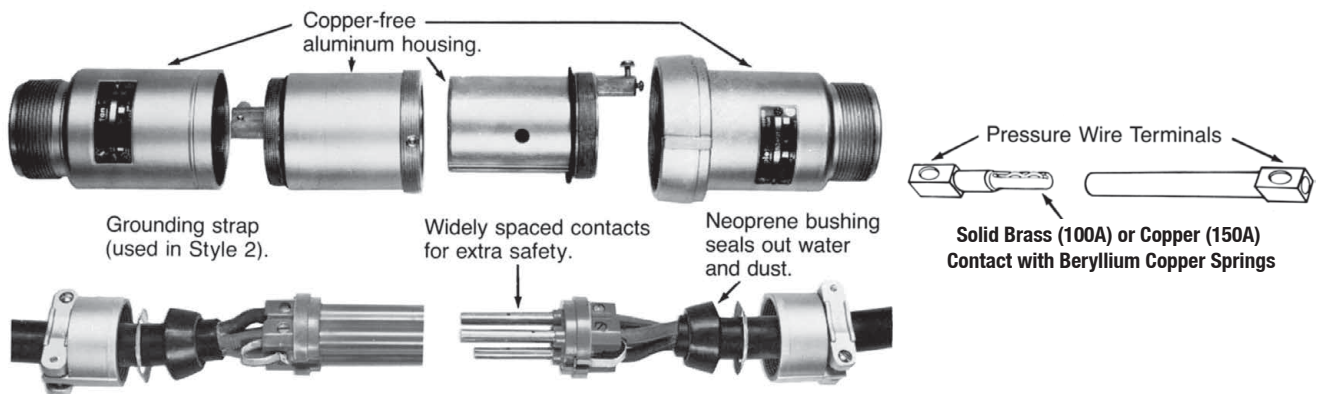

**Energized contacts** deeply recessed to reduce danger of accidental touching, minimize possibility of exposed arcs. Insulator quenches arcing, and is resistant to abnormal heat and to fire.

**Pressure wire terminals** allow cable to be readily replaced when necessary. Terminal screws grip conductors firmly. Spring contacts provide constant pressure.

**Plug mechanical cable clamps** provide strain relief at conductor connections, allow easy cable replacement.

① Plug and receptacle combination is NEMA 4X rated when clamping ring is fully tightened on receptacle.

# Powertite® 30, 60, 100, and 150 Amp Caps For Plug

## Applications

- Protects insulation and plug contacts from excessive moisture, dirt, dust, and corrosion when portable equipment is not in use.
- For use with 30 Amp 3-Pole and 4-Pole, 60 Amp 4-Pole and 100 and 150 Amp 4-Pole plugs.
- Cap is secured to plug by aviation cable. When in use the cap is held in place with standard plug clamping ring.

## Standard Materials

- Cap: blue ABS plastic



## Ordering Information

Catalog Number	Amp	For Use With
ACPCAP3034	30	ACP3023BC
		ACP3033BC
		ACP3034BC
		ACP3044BC
ACPCAP6004	60	ACP6034BC
		ACP6044BC
ACPCAP1004	100	ACP1034CD
		ACP1044CD
	150	ACP15034CD
		ACP15034DE

# Aluminum Mounting Boxes

## For Powertite® 30, 60, 100, and 150 Amp Receptacles

### 30 Amp



Hub Size (Inches)	AEE	AERH	AERC	AERA
1/2	AEE13	AERH13	AERC13	AERA13
3/4	AEE23	AERH23	AERC23	AERA23
1	AEE33	AERH33	AERC33	AERA33

### 60 and 100 Amp



Hub Size (Inches)	AEE	AERH	AERC	AERA
1	AEE36	AERH36	AERC36	AERA36
1-1/4	AEE46	AERH46	AERC46	AERA46
1-1/2	AEE56	AERH56	AERC56	AERA56

### 60, 100, and 150 Amp



Hub Size (Inches)	AJA Back Box and Adapter ①	Angle Adapter Only
1	AJA310	
1-1/4	AJA410	
1-1/2	AJA510	AJA100
2	AJA610	

### Replacement Receptacle Mounting Gasket

Amp	Back Box Type	Part Number
30	AEE, AERH, AERC, AERA	69060871000
60, 100	AEE, AERH, AERC, AERA	69060567000
60, 100, 150	AJA	69009497000

① Feed-Thru box furnished with one close-up plug in bottom recessed hub.

# Powertite® 30, 60, 100, and 150 Amp Replacement Interiors

600 Vac, 250 Vdc, 50-400 Hz

Plugs and Receptacles

NEC/CEC ORDINARY LOCATION PLUGS AND RECEPTACLES

## 30 Amp ①



Grounding Style	Wire/Pole	Receptacle	Plug	Receptacle	Plug
Style 1 (Shell Only)	2W, 2P	ARI-3022	API-3022	—	—
	3W, 3P	ARI-3033	API-3033	—	—
	4W, 4P	ARI-3044	API-3044	—	—
Style 2 (Shell and Extra Pole)	2W, 3P	—	—	ARI-3023	API-3023
	3W, 4P	—	—	ARI-3034	API-3034

## 60 Amp ①



Grounding Style	Wire/Pole	Receptacle	Plug	Receptacle	Plug
Style 1 (Shell Only)	2W, 2P	ARI-6022	API-6022	—	—
	3W, 3P	ARI-6033	API-6033	—	—
	4W, 4P	ARI-6044	API-6044	—	—
Style 2 (Shell and Extra Pole)	2W, 3P	—	—	ARI-6023	API-6023
	3W, 4P	—	—	ARI-6034	API-6034

## 100 and 150 Amp ①









Grounding Style	Wire/Pole	Receptacle	Plug	Receptacle	Plug
Style 1 (Shell Only)	2W, 2P	ARI-1022	API-1022	—	—
	3W, 3P	ARI-1033	API-1033	—	—
	4W, 4P	ARI-1044	API-1044	—	—
Style 2 (Shell and Extra Pole)	2W, 3P	—	—	ARI-1023	API-1023
	3W, 4P	—	—	ARI-1034	API-1034
150 Amp Style 2 (Shell and Extra Pole)	3W, 4P	—	—	ARI-15034	API-15034

① Pins and sleeves are not sold separately.



# Powertite® 30, 60, 100, and 150 Amp Replacement Parts

600 Vac, 250 Vdc, 50-400 Hz

	Description	Catalog Number
<b>ACP Plug Clamping Ring — Includes Gasket</b>		
	30 Amp — 2-, 3- and 4-Pole	CLMPR30
	30 Amp — 3-Wire, 4-Pole	30CRING ①
	60 Amp — 2- and 3-Pole	CLMPR23P60
	60 Amp — 4-Pole	CLMPR4P60
	100 Amp — 2- and 3-Pole	CLMPR23P100
	100 and 150 Amp — 4-Pole	CLMPR4P100
<b>Receptacle Spring Cover — Includes Gasket and Chain</b>		
	30 Amp — 2-, 3- and 4-Pole	PTSC30
	60 Amp — 2- and 3-Pole	PTSC60A
	60 Amp — 4-Pole	PTSC60B
	100 Amp — 2- and 3-Pole	PTSC100A
	100 and 150 Amp — 4-Pole	PTSC100B
<b>Receptacle Threaded Cover — Includes Gasket and Chain</b>		
	30 Amp — 2, 3, and 4-Pole	PTTC30
	30 Amp — 3 Wire, 4-Pole	30SCAP ①
	60 Amp — 2- and 3-Pole	PTTC60A
	60 Amp — 4-Pole	PTTC60B
	100 Amp — 2- and 3-Pole	PTTC100A
	100 and 150 Amp — 4-Pole	PTTC100B
<b>Bushing Bags and Crown Bushings for Plugs and Cable Connectors</b>		
	30 Amp	PTGB30
	60 Amp	PTGB60
	100 Amp and 150 Amp (CD)	PTGBCD
	150 Amp (DE)	PTGBDE
<b>Universal Plug Bushing</b>		
	30 and 60 Amp Cable Range 0.300" – 9.00" Package of 10	PTGBUBC
<b>Receptacle Ground Lug Kit</b>		
	30 Amp Receptacle Ground Lug Kit. Wire Well ID 0.272"	PTRGL30
	60 Amp Receptacle Ground Lug Kit. Wire Well ID 0.312"	PTRGL60
	100 Amp Receptacle Ground Lug Kit. Wire Well ID 0.389" ②	PTRGL100

① For use with 30 Amp Powertite plugs and WSR/WSRD/JBR/EBR/DBR receptacles.

② Ground lug is cast into the housing after 09/2008.

# Powertite® 30, 60, 100, and 150 Amp Mounted Receptacle Dimensions

600 Vac, 250 Vdc, 50-400 Hz

Plugs and Receptacles

NEC/CEC ORDINARY LOCATION PLUGS AND RECEPTACLES

## Receptacle Mounted on AEE Box

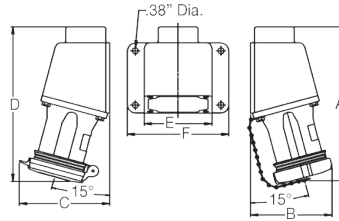

Amp	Dimensions in Millimeters (Inches)					
	A	B	C	D	E	F
30	174.7 (6.88)	89.6 (3.45)	100.3 (3.95)	181.1 (7.13)	107.9 (4.25)	127.0 (5.00)
60	247.6 (9.75)	120.1 (4.73)	126.4 (4.98)	254.0 (10.00)	136.6 (5.38)	162.0 (6.38)

## Receptacle Mounted on AJA Box

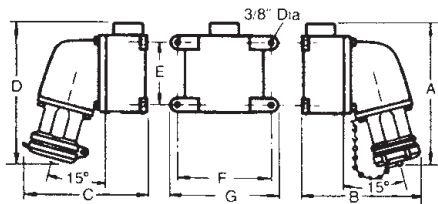

Amp	Dimensions in Millimeters (Inches)						
	A	B	C	D	E	F	G
60	244.6 (9.63)	203.2 (8.00)	223.7 (8.81)	271.5 (10.69)	123.9 (4.88)	174.7 (6.88)	200.15 (7.88)
100 and 150	290.5 (11.44)	228.6 (9.00)	233.4 (9.19)	300.2 (11.82)	123.9 (4.88)	174.7 (6.88)	200.15 (7.88)

## ADR Receptacle

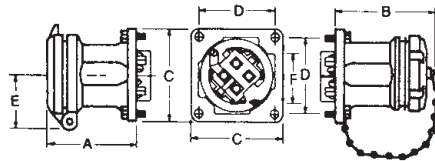

Amp	No. Poles	Dimensions in Millimeters (Inches)					
		A	B	C	D	E	F
30	2,3,4	71.1 (2.80)	81.0 (3.19)	85.8 (3.38)	69.0 (2.72)	52.3 (2.06)	69.8 (2.75)
60	2,3	123.9 (4.88)	117.6 (4.63)	107.9 (4.25)	88.9 (3.50)	58.6 (2.31)	78.7 (3.10)
60	4	123.9 (4.88)	117.6 (4.63)	107.9 (4.25)	88.9 (3.50)	61.9 (2.44)	85.0 (3.35)
100	2,3	129.5 (5.10)	139.7 (5.50)	107.9 (4.25)	88.9 (3.50)	61.9 (2.44)	86.3 (3.40)
100 and 150	4	129.5 (5.10)	139.7 (5.50)	107.9 (4.25)	88.9 (3.50)	65.0 (2.56)	91.4 (3.60)

# Powertite® 30, 60, 100, and 150 Amp Connector and Plug Dimensions

600 Vac, 250 Vdc, 50-400 Hz

## ARC Cable Connector

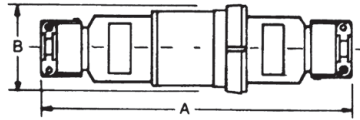

Amp	Dimensions in Millimeters (Inches)	
	A	B
30	266.7 (10.50)	79.5 (3.13)
60	336.5 (13.25)	96.7 (3.81)
100	406.4 (16.00)	107.9 (4.25)

## ACP Plug

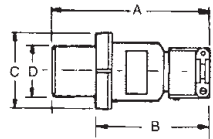

Amp	No. Poles	Dimensions in Millimeters (Inches)			
		A	B	C	D
30	2,3,4	152.4 (6.00)	120.6 (4.75)	79.5 (3.13)	47.2 (1.86)
60	2,3	198.3 (7.81)	125.4 (4.94)	88.9 (3.50)	56.6 (2.23)
60	4	198.3 (7.81)	125.4 (4.94)	96.7 (3.81)	64.7 (2.55)
100	2,3	266.7 (10.50)	168.4 (6.63)	101.6 (4.00)	62.7 (2.47)
100	4	266.7 (10.50)	168.4 (6.63)	107.9 (4.25)	69.0 (2.72)
150 (CD)	4	266.7 (10.50)	168.4 (6.63)	107.9 (4.25)	69.0 (2.72)
150 (DE)	4	340.3 (13.40)	247.1 (9.73)	107.9 (4.25)	69.0 (2.72)

## NMACP Plug

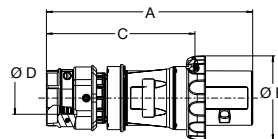

Amp	No. Poles	Dimensions in Millimeters (Inches)			
		A	B	C	D Min — Max
30	4	187.0 (7.36)	63.0 (2.48)	145.0 (5.71)	11.0 - 24.5 (0.43 - 0.97)
60	4	245.0 (9.65)	100.0 (3.94)	174.0 (6.85)	14.5 - 36.0 (0.57 - 1.42)

# Powertite® 30, 60, 100, and 150 Amp Mounting Box Dimensions

600 Vac, 250 Vdc, 50-400 Hz

Plugs and Receptacles

## AJA Mounting Boxes

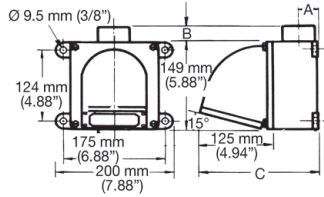

Amp	Hub Size (Inches)	Dimensions in Millimeters (Inches)		
		A	B ①	C
60, 100 and 150	1	28.7 (1.13)	14.2 (0.56)	203.2 (8.0)
	1-1/4	28.7 (1.13)	14.2 (0.56)	203.2 (8.0)
	1-1/2	38.1 (1.50)	14.2 (0.56)	203.2 (8.0)
	2	38.1 (1.50)	14.2 (0.56)	203.2 (8.0)

## AJA100 Angle Adapter

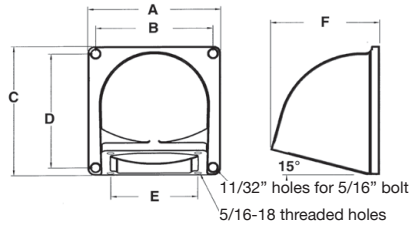

Dimensions in Millimeters (Inches)					
A	B	C	D	E	F
149.0 (5.87)	131.5 (5.18)	149.0 (5.87)	131.5 (5.18)	88.9 (3.50)	122.1 (4.81)

① AJA has two hubs. Close-up plug furnished in bottom recessed hub.

# Powertite® 30, 60, 100, and 150 Amp Mounting Box Dimensions

600 Vac, 250 Vdc, 50-400 Hz

## AERA ①, AERC ② and AERH Mounting Boxes

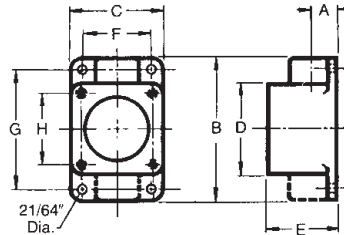

Amp	Hub Size (Inches)	Dimensions in Millimeters (Inches)									
		A ①	B ②	C	D	E	F	G	H	J	
30	1/2	17.5 (0.69)	134.8 (5.31)	85.8 (3.38)	85.8 (3.38)	63.5 (2.50)	66.8 (2.63)	115.8 (4.56)	69.0 (2.72)	23.8 (0.94)	
30	3/4	19.0 (0.75)	134.8 (5.31)	85.8 (3.38)	85.8 (3.38)	63.5 (2.50)	66.8 (2.63)	115.8 (4.56)	69.0 (2.72)	23.8 (0.94)	
30	1	20.5 (0.81)	134.8 (5.31)	85.8 (3.38)	85.8 (3.38)	63.5 (2.50)	66.8 (2.63)	115.8 (4.56)	69.0 (2.72)	23.8 (0.94)	
60	1	20.5 (0.81)	165.1 (6.50)	107.9 (4.25)	107.9 (4.25)	79.5 (3.13)	88.9 (3.50)	149.3 (5.88)	88.9 (3.50)	35.0 (1.38)	
60	1-1/4	23.8 (0.94)	165.1 (6.50)	107.9 (4.25)	107.9 (4.25)	79.5 (3.13)	88.9 (3.50)	149.3 (5.88)	88.9 (3.50)	35.0 (1.38)	
60	1-1/2	25.4 (1.00)	165.1 (6.50)	107.9 (4.25)	107.9 (4.25)	79.5 (3.13)	88.9 (3.50)	149.3 (5.88)	88.9 (3.50)	35.0 (1.38)	

## AEE Mounting Box

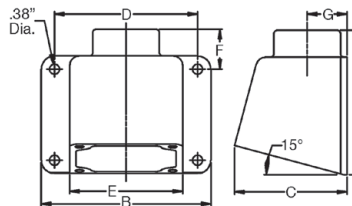

Amp	Hub Size (Inches)	Dimensions in Millimeters (Inches)						
		A	B	C	D	E	F	G
30	1/2, 3/4, 1	104.6 (4.12)	127.0 (5.00)	84.5 (3.33)	107.9 (4.25)	85.8 (3.38)	29.9 (1.18)	27.9 (1.10)
60	1, 1-1/4, 1-1/2	137.4 (5.41)	162.0 (6.38)	107.4 (4.23)	136.6 (5.38)	107.9 (4.25)	38.1 (1.50)	38.1 (1.50)

① Dimension "A" for AERA only.  
 ② Dimension "B" for AERC only.

# Powertite® 200 Amp Pin and Sleeve Spring Door Plugs and Receptacles

600 Vac, 250 Vdc, 50-400 Hz.

Wire Recess Diameter: .687". Wire Size Range: 250 MCM-#2/0. Pressure Wire Terminals ①.

NEC/CEC:  
NEMA 3, 3R, 4, 4X

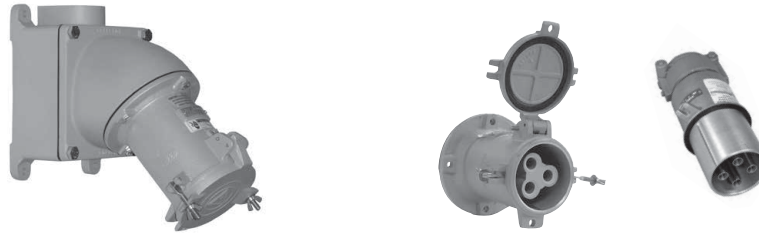

Plugs and Receptacles

NEC/CEC ORDINARY LOCATION PLUGS AND RECEPTACLES

Grounding Style	Wire/Pole	Receptacle with AJA Mounting Box ②	Hub Size (Inches)	Receptacle Only ③	Plug Only	Cable Dia. (Inches)
Style 1 (Shell Only)	3W, 3P	ADJA20033-150	1-1/2	ADR20033	AP20033CD	.875 to 1.906
		ADJA20033-200	2		AP20033E	1.875 to 2.500
	4W, 4P	ADJA20044-200	2	ADR20044	AP20044CD	.875 to 1.906
		ADJA20044-250	2-1/2		AP20044E	1.875 to 2.500
Style 2 (Shell and Extra Pole)	2W, 3P	ADJA20023-150	1-1/2	ADR20023	AP20023CD	.875 to 1.906
		ADJA20023-200	2		AP20023E	1.875 to 2.500
		ADJA20023-250	2-1/2			
	3W, 4P	ADJA20034-150	1-1/2	ADR20034	AP20034CD	.875 to 1.906
		ADJA20034-200	2		AP20034E	1.875 to 2.500
		ADJA20034-250	2-1/2			

For Reverse Service add suffix **-RS** to Catalog Number.  
For Special Polarization, add suffix **-P4** to Catalog Number.

## Maximum Conductor Size

Wire Recess Dia. (Inches)	Conductor Size	Max. Strand	Type Conductor
0.687	250 MCM	37	General Wire
	4/0	19	General Wire
	4/0	259	Flexible Cable
	3/0	427	Extra Flexible Cable
	2/0	259	Flexible Cable
	2/0	259	Flexible Cable

## Horsepower Ratings for Emergency Disconnect Under Load

Plug may be withdrawn in an emergency if within these maximum HP ratings. Not for normal starting and stopping.

Motor Phase	Wire/Pole	Motor Horsepower			
		120 Vac	240 Vac	480 Vac	600 Vac
1-Phase	2W, 3P	15HP	30HP	40HP	40HP
3-Phase	3W, 3P; 3W, 4P; or 4W, 4P	20HP	40HP	50HP	50HP

① Adapters for #4-#1 wire available, see Powertite® 200 and 400 Amp Replacement Parts.

② For additional mounting boxes, see Aluminum Mounting Boxes.

③ Receptacle meets NEMA 3R with spring door closed and NEMA 3, 3R, 4, 4X with plug fully inserted and wing nuts fully tightened or cover closed with wing nuts fully tightened.



# Powertite® 200 Amp Pin and Sleeve Clamp Cover Plugs, Connectors and Receptacles

600 Vac, 250 Vdc, 50-400 Hz.

Wire Recess Diameter: .687". Wire Size Range: 250 MCM-#2/0. Pressure Wire Terminals ①.

NEC/CEC:  
NEMA 3, 3R, 4, 4X



Grounding Style	Wire/Pole	Receptacle with AJA Mounting Box ②	Hub Size (Inches)	Receptacle Only ③	Connector Body Only	Plug Only ④	Cable Dia. (Inches)	
Style 1 (Shell Only)	3W, 3P	AJA20033-150	1-1/2	AR20033	ARC20033CD	AP20033CD	.875 to 1.906	
		AJA20033-200	2		ARC20033E	AP20033E	1.875 to 2.500	
	4W, 4P	AJA20044-200	2	AR20044	ARC20044CD	AP20044CD	.875 to 1.906	
		AJA20044-250	2-1/2		ARC20044E	AP20044E	1.875 to 2.500	
Style 2 (Shell and Extra Pole)	2W, 3P	AJA20023-150	1-1/2	AR20023	ARC20023CD	AP20023CD	.875 to 1.906	
		AJA20023-200	2		ARC20023E	AP20023E	1.875 to 2.500	
	3W, 4P	AJA20034-150	1-1/2	AR20034	ARC20034CD	AP20034CD	.875 to 1.906	
		AJA20034-200	2		ARC20034E	AP20034E	1.875 to 2.500	
			AJA20034-250	2-1/2		ARC20034E	AP20034E	1.875 to 2.500

For Reverse Service add suffix **-RS** to Catalog Number.  
For Special Polarization, add suffix **-P4** to Catalog Number.

## Pin and Sleeve Design

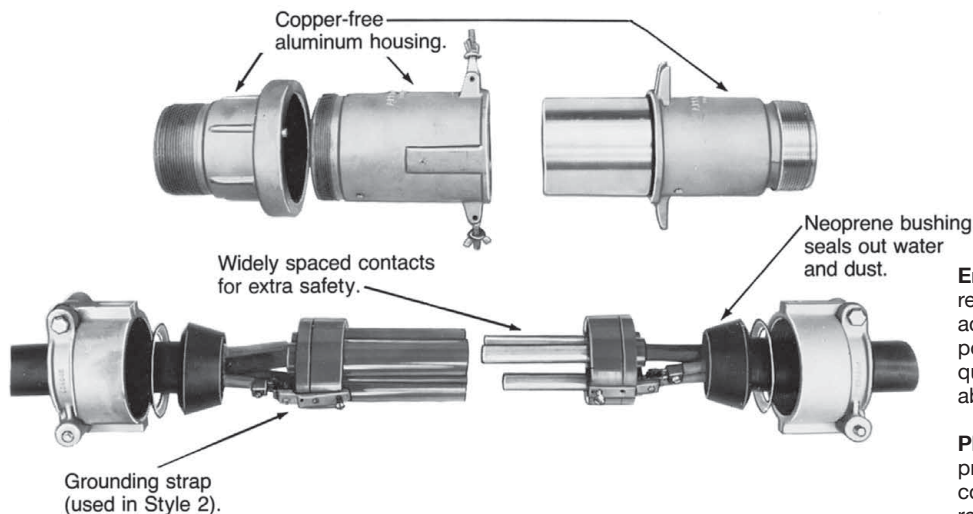

**Energized contacts** deeply recessed to reduce danger of accidental touching, minimize possibility of exposed arcs. Insulator quenches arcing, and is resistant to abnormal heat and to fire.

**Plug mechanical cable clamps** provide strain relief at conductor connections, allow easy cable replacement.

① Adapters for #4-#1 wire available, see Powertite® 200 and 400 Amp Replacement Parts.

② For additional mounting boxes, see Aluminum Mounting Boxes.

③ Receptacle meets NEMA 3, 3R, 4, 4X with plug fully inserted and wing nuts fully tightened or clamp cover installed with wing nuts fully tightened.

④ Plug and connector body combination is NEMA 4X rated when wing nuts are fully tightened on connector body.

# Powertite® 400 Amp Pin and Sleeve Clamp Cover Plugs and Receptacles: Weatherproof

600 Vac, 250 Vdc, 50-400 Hz.

Wire Recess Diameter: .84" or 1.25". Wire Size Range: 400MCM—1000MCM. Solder Wire Terminals.

NEC/CEC:  
NEMA 3, 3R, 4 ③

Plugs and Receptacles

NEC/CEC ORDINARY LOCATION PLUGS AND RECEPTACLES

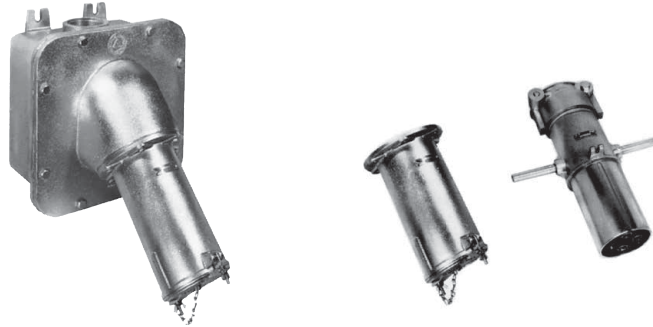

Wire Recess Dia. (Inches)	Grounding Style	Wire/Pole	Receptacle with AJA Mounting Box	Hub Size (Inches) ②	Receptacle Only	Plug Only	Cable Dia. (Inches)
0.84 ①	Style 1 (Shell Only)	3W, 3P	AJA40033-400	4	AR40033	AP40033E	1.875 to 2.500
		4W, 4P	AJA40044-400		AR40044	AP40044E	1.875 to 2.500
		4W, 4P	AJA40044-400N4		AR40044N4	AP40044E	1.875 to 2.500
	Style 2 (Shell and Extra Pole)	2W, 3P	AJA40023-400	4	AR40023	AP40023E	1.875 to 2.500
		3W, 4P	AJA40034-400		AR40034	AP40034E	1.875 to 2.500
		3W, 4P	AJA40034-400N4		AR40034N4	AP40034E	1.875 to 2.500
1.25	Style 1 (Shell Only)	3W, 3P	AJA40133-400	4	AR40133	AP40133F	2.500 to 3.000
					AP40133G	3.000 to 3.500	
		4W, 4P	AJA40144-400		AR40144	AP40144F	2.500 to 3.000
					AP40144G	3.000 to 3.500	
		4W, 4P	AJA40144-400N4	4	AR40144N4	AP40144G	3.000 to 3.500
		2W, 3P	AJA40123-400	4	AR40123	AP40123F	2.500 to 3.000
	Style 2 (Shell and Extra Pole)				AP40123G	3.000 to 3.500	
		3W, 4P	AJA40134-400	4	AR40134	AP40134F	2.500 to 3.000
					AP40134G	3.000 to 3.500	
		3W, 4P	AJA40134-400N4	4	AR40134N4	AP40134G	3.000 to 3.500

**Solder wire terminals standard on all models.**

For Reverse Service add suffix **-RS** to Catalog Number.  
For Special Polarization add suffix **-P4** to Catalog Number.  
Note: Box can be turned for vertical or horizontal mount.

**Maximum Conductor Size**

400 Amp not horsepower rated. Plug is for disconnecting use only — not for current rupturing.

Solder Recess Dia. (Inches)	Conductor Size	Max. Strand	Type Conductor
0.84	500 MCM	37	General Wire
	400 MCM	259	Flexible Cable
	400 MCM	427	Extra Flexible Cable
1.25	1000 MCM	61	General Wire
	900 MCM	427	Flexible Cable
	800 MCM	703	Extra Flexible Cable

① Pressure terminal kits available for .84 wire recess size only to convert solder terminal to pressure terminal. See Replacement Parts page.

② Has feed-thru 4" tapped openings. Supplied with one 4" to 3" reducer and one 4" close-up plug.

③ 400 Amp versions with the **-N4** suffix are NEMA 4 rated.

# Powertite® 400 Amp Pin and Sleeve Connectors and Plugs: Weatherproof

600 Vac, 250 Vdc, 50-400 Hz.

Wire Recess Diameter: .84" or 1.25". Wire Size Range: 400MCM—1000MCM. Solder Wire Terminals.

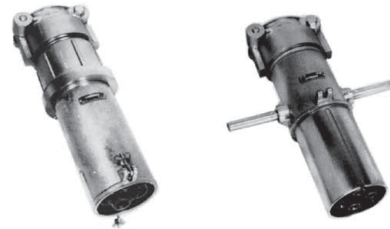

Wire Recess Dia. (Inches)	Grounding Style	Wire/Pole	Connector Body Only	Plug Only	Cable Dia. (Inches)
0.84 ①	Style 1 (Shell Only)	3W, 3P	<b>ARC40033E</b>	<b>AP40033E</b>	1.875 to 2.500
		4W, 4P	<b>ARC40044E</b>	<b>AP40044E</b>	1.875 to 2.500
	Style 2 (Shell and Extra Pole)	2W, 3P	<b>ARC40023E</b>	<b>AP40023E</b>	1.875 to 2.500
		3W, 4P	<b>ARC40034E</b>	<b>AP40034E</b>	1.875 to 2.500
1.25	Style 1 (Shell Only)	3W, 3P	<b>ARC40133F</b>	<b>AP40133F</b>	2.500 to 3.000
			<b>ARC40133G</b>	<b>AP40133G</b>	3.000 to 3.500
		4W, 4P	<b>ARC40144F</b>	<b>AP40144F</b>	2.500 to 3.000
		<b>ARC40144G</b>	<b>AP40144G</b>	3.000 to 3.500	
	Style 2 (Shell and Extra Pole)	2W, 3P	<b>ARC40123F</b>	<b>AP40123F</b>	2.500 to 3.000
			<b>ARC40123G</b>	<b>AP40123G</b>	3.000 to 3.500
		3W, 4P	<b>ARC40134F</b>	<b>AP40134F</b>	2.500 to 3.000
		<b>ARC40134G</b>	<b>AP40134G</b>	3.000 to 3.500	

**Solder wire terminals standard on all models.**  
 For Reverse Service add suffix **-RS** to Catalog Number.  
 For Special Polarization add suffix **-P4** to Catalog Number.

## Pin and Sleeve Design

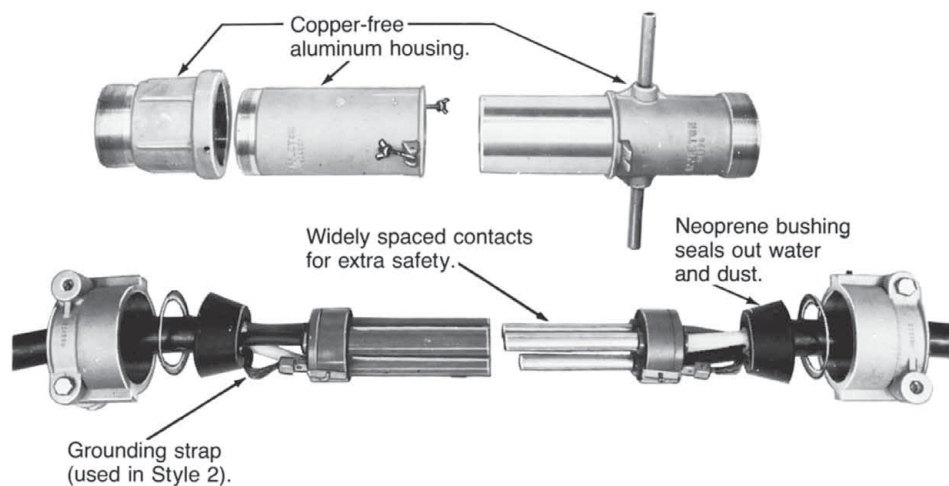

**Energized contacts** deeply recessed to reduce danger of accidental touching, minimize possibility of exposed arcs. Insulator quenches arcing, and is resistant to abnormal heat and to fire.

**Plug mechanical cable clamps** provide strain relief at conductor connections, allow easy cable replacement.

① Pressure terminal kits available for .84 wire recess size only to convert solder terminal to pressure terminal. See Replacement Parts page.

# Powertite® 200 and 400 Amp Mounting Boxes and Replacement Interiors

600 Vac, 250 Vdc, 50-400 Hz.

Plugs and Receptacles

NEC/CEC ORDINARY LOCATION PLUGS AND RECEPTACLES

## 200 Amp Mounting Boxes and Angle Adapter

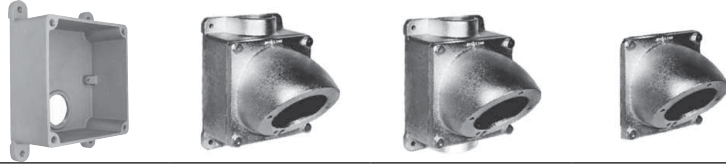

Hub Size (Inches)	AJB	AJA	AJAC (Feed-Thru)	AJA200 (Angle Adapter Only)
1-1/2 NPT	—	AJA520	—	AJA200
2 NPT	AJB620	AJA620	—	AJA200
2-1/2 NPT	—	AJA720	AJAC720	AJA200
2-3/8 (Slip Hole)	AJB238	—	—	—

## 400 Amp Mounting Box and Angle Adapter



Hub Size (Inches)	AJAC ①	AJA400 (Angle Adapter Only)
4	AJAC400	AJA400

## 200 Amp Interiors ②



Grounding Style	Wire/Pole	Receptacle	Plug	Receptacle	Plug
Style 1 (Shell Only)	3W, 3P	ARI20033	API20033	—	—
	4W, 4P	ARI20044	API20044	—	—
Style 2 (Shell and Extra Pole)	2W, 3P	—	—	ARI20023	API20023
	3W, 4P	—	—	ARI20034	API20034

## 400 Amp Interiors ②









Wire Recess Dia. (Inches)	Grounding Style	Wire/Pole	Receptacle	Plug	Receptacle	Plug
.84	Style 1 (Shell Only)	3W, 3P	ARI40033	API40033	—	—
		4W, 4P	ARI40044	API40044	—	—
	Style 2 (Shell and Extra Pole)	2W, 3P	—	—	ARI40023	API40023
		3W, 4P	—	—	ARI40034	API40034
1.25	Style 1 (Shell Only)	3W, 3P	ARI40133	API40133	—	—
		4W, 4P	ARI40144	API40144	—	—
	Style 2 (Shell and Extra Pole)	2W, 3P	—	—	ARI40123	API40123
		3W, 4P	—	—	ARI40134	API40134

① Has feed-thru 4" tapped openings. Supplied with one 4" to 3" reducer and one 4" close-up plug.

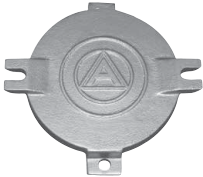
② Pins and sleeves are not sold separately.

# Powertite® 200 and 400 Amp Replacement Parts

600 Vac, 250 Vdc, 50-400 Hz.

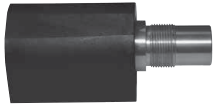
	Description	Catalog Number
<b>Receptacle Covers</b>		
	<b>Spring Cover — Includes Gasket</b>	
	200 Amp — 2- and 3-Pole	PTLC200A
	200 Amp — 4-Pole	PTLC200B
<b>Clamping Cover — Includes Gasket and Chain</b>		
	200 Amp — 2- and 3-Pole	PTBC200A
	200 Amp — 4-Pole	PTBC200B
	400 Amp — 2- and 3-Pole	PTBC400A
	400 Amp — 4-Pole	PTBC400B
<b>Bushing Bags for Plugs and Cable Connectors</b>		
	200 Amp - Suffix CD	PTGBCD
	200 Amp - Suffix E	PTGB200E
	400 Amp - Suffix E	PTGB400E
	400 Amp - Suffix F	PTGB400F
	400 Amp - Suffix G	PTGB400G
<b>Receptacle Lockout Device</b>		
	Lockout, 200 Amp 3- and 4-Pole Models	PTLOCK2004
	Lockout, 400 Amp 4-Pole Models	PTLOCK4004
<b>Optional Accessory for Wire Size #1 to #4</b>		
<i>Check National Electrical Code for proper wire size and application</i>		
	200 Amp, 3-Pole Wire Adapter Kit	PTK200WA3
	200 Amp, 4-Pole Wire Adapter Kit	PTK200WA4
<b>400 Amp Pressure Terminal Kits</b>		
	<b>Use with 400-500 MCM Wire</b> <i>0.84" I.D. Wire Recess</i>	
	3 Adapters	PTK84-3P
	4 Adapters	PTK84-4P
	<b>Use With 750 MCM General Wire or 500-777 MCM Flexible Wire</b> <i>1.18" I.D. Wire Recess</i>	
	3 Adapters	PTK750-3P
	4 Adapters	PTK750-4P

Plugs and Receptacles

NEC/CEC ORDINARY LOCATION PLUGS AND RECEPTACLES

# Powertite® 200 Amp Mounted Receptacle Dimensions

600 Vac, 250 Vdc, 50-400 Hz.

Plugs and Receptacles

## Receptacle Mounted on AJA and AJAC Boxes

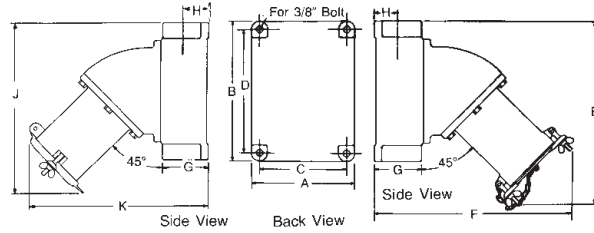

Dimensions in Millimeters (Inches)

A	B	C	D	E	F	G	H	J	K
203.2 (8.00)	273.0 (10.75)	171.4 (6.75)	241.3 (9.50)	355.6 (14.00)	387.3 (15.25)	95.2 (3.75)	47.7 (1.88)	342.9 (13.50)	361.9 (14.25)

## Receptacle

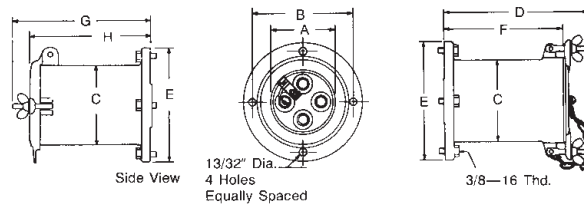

Dimensions in Millimeters (Inches)

No. Poles	A	B	C	D	E	F	G	H
3	82.5 (3.25)	143.0 (5.63)	10.46 (4.19)	203.2 (8.00)	168.4 (6.63)	166.6 (6.56)	170.1 (6.70)	179.0 (7.05)
4	92.2 (3.63)	143.0 (5.63)	115.8 (4.56)	203.2 (8.00)	168.4 (6.63)	166.6 (6.56)	170.1 (6.70)	179.0 (7.05)

NEC/CEC ORDINARY LOCATION PLUGS AND RECEPTACLES



# Powertite® 200 Amp Connector, Plug and Adapter Dimensions

600 Vac, 250 Vdc, 50-400 Hz.

## Connector Body

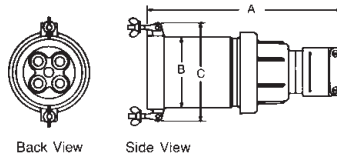

No. Poles	Dimensions in Millimeters (Inches)		
	A	B	C
3	330.2 (13.00)	106.4 (4.19)	136.6 (5.38)
4	330.2 (13.00)	115.8 (4.56)	146.0 (5.75)

## Plug

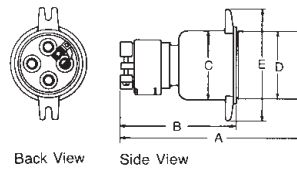

No. Poles	Dimensions in Millimeters (Inches)				
	A	B	C	D	E
3	303.2 (11.94)	198.3 (7.81)	96.7 (3.81)	95.2 (3.75)	163.5 (6.44)
4	303.2 (11.94)	198.3 (7.81)	106.4 (4.19)	104.95 (4.13)	172.9 (6.81)

## AJA200 Angle Adapter

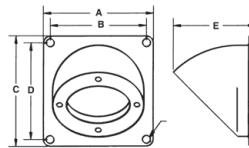

Dimensions in Millimeters (Inches)				
A	B	C	D	E
203.2 (8.0)	177.8 (7.0)	203.2 (8.0)	177.8 (7.0)	152.4 (6.0)

Plugs and Receptacles

NEC/CEC ORDINARY LOCATION PLUGS AND RECEPTACLES

# Powertite® 400 Amp Mounted Receptacle and Receptacle Dimensions

600 Vac, 250 Vdc, 50-400 Hz.

Plugs and Receptacles

NEC/CEC ORDINARY LOCATION PLUGS AND RECEPTACLES

## Receptacle Mounted on AJAC Box

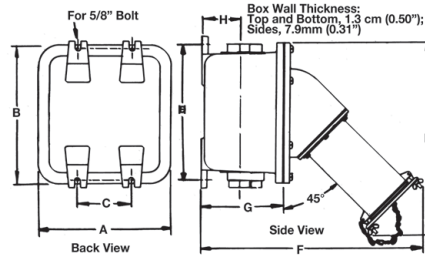

Hub Size ①	Dimensions in Millimeters (Inches)							
	A	B	C	D	E	F	G	H
4.00/10.16	403.3 (15.88)	403.3 (15.88)	165.1 (6.50)	384.3 (15.13)	558.8 (22.00)	615.9 (24.25)	215.9 (8.50)	98.5 (3.88)

## Receptacle

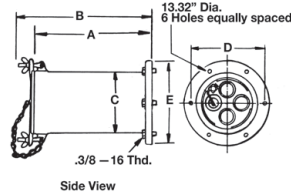

No. Poles	Dimensions in Millimeters (Inches)					
	A	B	C	D	E	F
3	285.7 (11.25)	311.1 (12.25)	130.3 (5.13)	171.4 (6.75)	196.8 (7.75)	106.4 (4.19)
4	285.7 (11.25)	311.1 (12.25)	143.0 (5.63)	171.4 (6.75)	196.8 (7.75)	119.1 (4.69)

① AJAC box has feed-thru 101.6 mm (4") openings. Supplied with one 101.6 mm (4") to 76.2 mm (3") reducer, and one 101.6 mm (4") close-up plug.

# Powertite® 400 Amp Connector and Plug Dimensions

600 Vac, 250 Vdc, 50-400 Hz.

## Plug

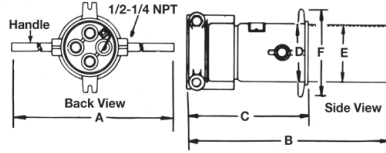

No. Poles	Dimensions in Millimeters (Inches)					
	A	B	C	D	E	F
3	381.0 (15.00)	482.6 (19.00)	285.7 (11.25)	119.3 (4.70)	118.3 (4.66)	190.5 (7.50)
4	393.7 (15.50)	482.6 (19.00)	285.7 (11.25)	131.8 (5.19)	131.0 (5.16)	203.2 (8.00)

## Connector Body

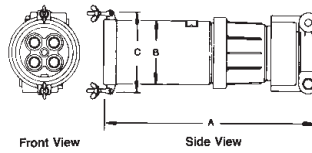

No. Poles	Dimensions in Millimeters (Inches)		
	A	B	C
3	482.6 (19.00)	130.3 (5.13)	184.1 (7.25)
4	482.6 (19.00)	143.0 (5.63)	196.8 (7.75)

Plugs and Receptacles

NEC/CEC ORDINARY LOCATION PLUGS AND RECEPTACLES