

# U-Line® Factory Sealed 15 and 20 Amp Plugs and Receptacles

CSA Certification Only. Explosionproof, Dust-Ignitionproof

Dead-Front Safety Construction – Grounding through Extra Pole and Shell.

Class I, Division 1 and 2 Groups B, C, D  
Class II, Division 1 and 2 Group G and Coal Dust  
Class III  
CSA Type 7BCD, 9G

## Applications

- Locations where receptacles are used with stationary or portable electrically operated devices such as:
  - Lighting systems
  - Conveyors
  - Heaters
  - Motor-generator sets
  - Air conditioners
  - Compressors
  - Pumps
- Locations with damp or corrosive conditions.
- Class I: classified locations where ignitable vapors or gases are present such as:
  - Petrochemical plants
  - Petroleum refineries
  - Paint and chemical plants
- Class II: classified locations such as:
  - Process industries where there are dust hazards from handling such products as flour, grain and starch or any location where ignitable amounts of dust are present or amounts which would adversely affect performance.



## Standard Materials

- Receptacle, cover and mounting box: copperfree (4/10 of 1% max.) aluminum
- ECP plugs: copperfree (4/10 of 1% max.) aluminum housings
- Insulating blocks: glass-filled reinforced polyester

## Standard Finishes

- Receptacles: epoxy powder coat
- Cord connector housings and caps: epoxy powder coat

## Certifications and Compliances

- CSA Standard: C22.2 No. 25, C22.2 No. 30, C22.2 No 42, C22.2 No.159
- CSA Certified: 038644

## Features

- Intermateable with competitor's plugs of like configurations.
- Factory sealed, external seals not required. Arcing is safely confined to receptacle interior.
- Energized receptacle contacts deeply recessed to reduce danger of accidental touching.
- Unique blade-type, brass contacts exert constant pressure along entire contact surface and provide superior electrical contact.
- Insulators provide superior dielectric and mechanical strength and lowest arc tracking.
- ECP plug fits any standard non-explosionproof receptacle (NEMA 5-15R, 5-20R, or 6-20R) as well as U-Line explosionproof receptacles.

## Illustrated Features

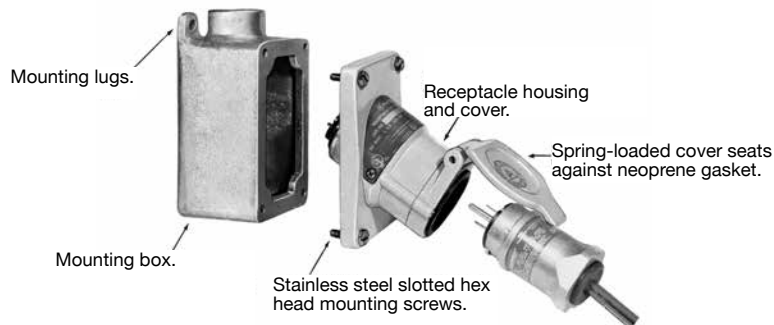

CSA Approved when used with Killark® "UGR" Series and Crouse-Hinds® "ENR" Series receptacles. Crouse-Hinds and ENP are registered trademarks of Cooper Crouse-Hinds. Killark and UGR are registered trademarks of Hubbell Incorporated.

⚡ CSA Certification only.

# U-Line® Factory Sealed 15 and 20 Amp Plugs and Receptacles

CSA Certification Only. Explosionproof, Dust-Ignitionproof

Dead-Front Safety Construction – Grounding through Extra Pole and Shell.

Class I, Division 1 and 2 Groups B, C, D  
Class II, Division 1 and 2 Group G and Coal Dust  
Class III  
CSA Type 7BCD, 9G

## Illustrated Features

**Spring door cover** keeps dust out of receptacle when plug is not in use, which may be rotated 180° or completely removed. Stainless steel cover spring-completely enclosed for protection from corrosive environments. Cover may be used with hinge at top (standard) or rotated 180° to put hinge at bottom.

**Factory sealed receptacle/switch interior.** Switch is an integral part of receptacle interior, contained in an aluminum sleeve. Protective xylan coating on inside of sleeve provides smooth “rotating” action of internal switch, which is activated by rotating plug in receptacle. Entire aluminum sleeve is sealed at both ends with neoprene O-rings to protect receptacle/switch interior against moisture.

**ECP Interchanger™ plug** fits ordinary location receptacles (NEMA 5-20R or 15R and NEMA 6-20R) and explosionproof U-Line receptacle as well competitors comparable NEMA blade configured receptacles.

**Solderless lugs**—all terminals are pressure type to facilitate wiring.

**Longer plug housing** for better gripping and easier plug insertion and withdrawal.

**Knock-out in plug** insulator permits “potting” of terminations for positive protection in severe environments.

**A twist of the plug** produces audible “click” to indicate fast make and break of built-in switch contacts. Twisting plug locks it in place—cannot be accidentally pulled out.

**With plug in use,** neoprene gasket in throat of receptacle “seals” around plug keeping out dirt, water, dust and other foreign matter.

**With plug not in use,** spring-loaded door seats against neoprene gasket to seal receptacle from corrosive atmospheres.



**For safety...** Ordinary location plug will NOT activate explosionproof U-Line receptacle.

**Plug mechanical cable clamps** on the plug prevent strain on cables and meet or exceed UL 150 lb. strain relief pull-out test for classified locations.



**Special neoprene watertight plug bushing** accommodates flexible cord ranging from .538” to .639” in diameter.



Plugs and Receptacles

PLUGS AND RECEPTACLES: HAZARDOUS LOCATION

CSA Certification only.



# U-Line® Factory Sealed 15 and 20 Amp Plugs and Receptacles

CSA Certification Only. Explosionproof, Dust-Ignitionproof



Dead-Front Safety Construction – Grounding through Extra Pole and Shell.

Class I, Division 1 and 2 Groups B, C, D  
 Class II, Division 1 and 2 Group G and Coal Dust  
 Class III  
 CSA Type 7BCD, 9G

## Receptacle and Cover Assembly

Description	Catalog Number	
	125 Vac, 1 HP 	250 Vac, 2 HP 
 20 Amp	ECSK-2023	ECSK-20232

## Mounting Box – Complete with 1 Close-Up Plug

	Hub Size	Catalog Number
<b>Single Gang</b>		
	3/4"	ECS-175
	1"	ECS-110
<b>Two Gang</b>		
	3/4"	ECS-275
	1"	ECS-210

## Dimensions

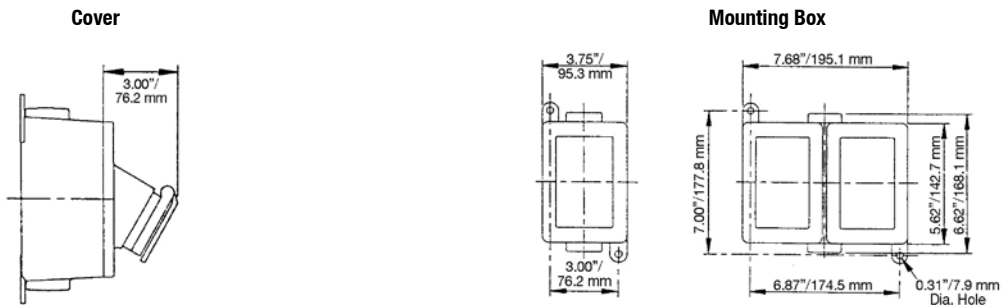

 CSA Certification only.

# U-Line® Factory Sealed 15 and 20 Amp Plugs

## Explosionproof, Dust-Ignitionproof

These watertight plugs also fit NEMA 5-15R, 5-20R or 6-20R receptacles in nonclassified areas. Choice of Aluminum or Thermoplastic Polyester Plug.

Class I, Division 1 and 2 Groups B, C, D  
 Class II, Division 1 and 2 Group G and Coal Dust  
 Class III  
 CSA Type 7BCD, 9G

### Applications

- U-Line® Interchanger™ ECP plug: suitable for use in such areas as refineries, petrochemical plants, and other areas subject to where ignitable gases are present.
- NCP Plug: ideal where moisture or corrosion is a constant problem, such as production facilities on marine platforms, and pipeline transportation facilities.











### Features

- Unique blade-type, brass contacts exert constant pressure along entire contact surface and provide superior electrical contact.
- Insulators provide superior dielectric and mechanical strength and lowest arc tracking.
- Longer plug housing for better gripping and easier plug insertion and withdrawal.

- Plugs fits any standard non-explosionproof receptacle (NEMA 5-15R, 5-20R, or 6-20R) as well as U-Line explosionproof receptacles.
- 15 Amp ECP1523 125 Vac and 20 Amp ECP2023 125 Vac U-Line plugs are for use in the T-slot configured 20 Amp U-Line receptacle. ie ECSK-2023.
- ECP plug: a twist of the plug produces audible “click” to indicate fast make and break of built-in switch contacts. Twisting plug locks it in place and cannot be accidentally pulled out.
- NCP plug: special neoprene watertight plug bushing accommodates flexible cord ranging from .538” to .639” diameter.

### Standard Materials

- ECP plug: copperfree (less than 4/10ths of 1%) aluminum
- NCP plug: 30% glass-reinforced thermoplastic polyester

	Amp	Diagram	Wire/ Pole	Cable Dia., (Inches)	Catalog Number	
					125 Vac 	250 Vac 
<b>U-Line® Interchanger™ ECP Standard Plug</b>						
	15		2W, 3P	.538 to .639	<b>ECP-1523</b>	—
	20		2W, 3P	.538 to .639	<b>ECP-2023</b>	—
	20		2W, 3P	.538 to .639	—	<b>ECP-20232</b>
<b>NCP Plug</b>						
	15		2W, 3P	.538 to .639	<b>NCP-1523</b>	—
	20		2W, 3P	.538 to .639	<b>NCP-2023</b>	—
	20		2W, 3P	.538 to .639	—	<b>NCP-20232</b>

### Dimensions

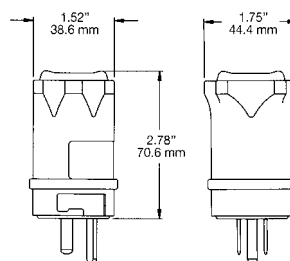

 CSA Certification only.

# U-Line® 20 Amp ECK-GFI Ground Fault Circuit Interrupter and Receptacle

CSA Certification Only. Explosionproof, Dust-Ignitionproof

Dead-Front Safety Construction – Grounding through Extra Pole and Shell.

Class I, Division 1 and 2, Groups B, C, D  
Class I Zone 1 and 2, IIB + H<sub>2</sub> T6  
Class II, Division 1 and 2, Groups E, F, G  
Class III, Encl. 3R, weatherproof  
CSA Type 3R, 7BCD, 9EFG  
CSA Approved

Class I, Division 1 and 2 Groups B, C, D  
Class II, Division 1 and 2 Group G and Coal Dust  
Class III  
CSA Type 7BCD, 9G

## Applications

- Provides required ground fault protection for portable electrically-operated devices. Meets all CSA requirements for ground fault protection in hazardous locations.
- Well suited for use in highly corrosive atmospheres and wet locations.
- Can be used in conjunction with U-Line factory sealed receptacle on 20 Amp, 125 Vac branch circuits.

## Features

- Rated 20 Amp, 125 Vac, 5 mA trip setting. 0.075 second trip time.
- Smooth-operating test and reset buttons.
- Can be installed in standard ECS Series mounting boxes.

## Standard Materials

- Cover: cast copperfree (less than 4/10ths of 1%) aluminum
- Push Buttons: Aluminum Upper Barrel and phelonic lower barrel (Dust cap models have neoprene buttons)

## Standard Finish

- Cover: baked gray epoxy clad finish

## Options

- Securing rod for push button factory sealed units. Add suffix — **S153**.
- CSA Type 4X enclosure and cover. Add suffix — **4X**.
- Flush mounted single LED trip indicator light. Add suffix **-LED**.

## Certifications and Compliances

- CSA Standard: C22.2 No. 25, C22.2 No. 30, C22.2 No.42, C22.2 No. 159
- CSA Certified: 038644



Ground Fault Circuit Interrupter Cover Assembly



2-Gang — GFCI and Receptacle

# U-Line® 20 Amp ECK-GFI Ground Fault Circuit Interrupter and Receptacle

CSA Certification Only. Explosionproof, Dust-Ignitionproof

Dead-Front Safety Construction – Grounding through Extra Pole and Shell.

Class I, Division 1 and 2, Groups B, C, D  
 Class I Zone 1 and 2, IIB + H<sub>2</sub> T6  
 Class II, Division 1 and 2, Groups E, F, G  
 Class III, Encl. 3R, weatherproof  
 CSA Type 3R, 7BCD, 9EFG  
 CSA Approved

Class I, Division 1 and 2 Groups B, C, D  
 Class II, Division 1 and 2 Group G and Coal Dust  
 Class III  
 CSA Type 7BCD, 9G

	Hub Size (Inches)	Electrical Rating	Catalog Number
<b>Ground Fault Circuit Interrupter – 1-Gang – Non-Factory Sealed Devices</b>			
	1/2 – 3/4	20 Amp 120 Vac, 5 mA Trip 0.075 Sec. Trip Time	<b>ECS2GFI</b>
	1	20 Amp 120 Vac, 5 mA Trip 0.075 Sec. Trip Time	<b>ECS4GFI</b>

## U-Line Receptacles – Factory Sealed Device. Not approved for Group E \*

	Hub Size (Inches)	Electrical Rating	Catalog Number
<b>1-Gang</b>			
	1/2 – 3/4	20 Amp 125 Vac, 1 HP	<b>ECS32023</b>
	1	20 Amp 125 Vac, 1 HP	<b>ECS52023</b>
	1/2 – 3/4	20 Amp 250 Vac, 2 HP	<b>ECS320232</b>
	1	20 Amp 250 Vac, 2 HP	<b>ECS520232</b>
<b>2-Gang with two, single receptacle covers</b>			
	1/2 – 3/4	15/20 Amp 125 Vac, 1 HP	<b>ECS72023</b>
	1	15/20 Amp 125 Vac, 1 HP	<b>ECS92023</b>
	1/2 – 3/4	15/20 Amp 250 Vac, 2 HP	<b>ECS720232</b>
	1	15/20 Amp 250 Vac, 2 HP	<b>ECS920232</b>

## U-Line Plugs and Receptacles with Ground Fault Protection – 2-Gang – Non-Factory Sealed Devices

	Hub Size (Inches)	Electrical Rating	Catalog Number
	1/2 – 3/4	20 Amp 125 Vac, 1 HP	<b>ECS6GFI2023</b>
	1	20 Amp 125 Vac, 1 HP	<b>ECS8GFI2023</b>

	Description	Catalog Number Single Gang
<b>Ground Fault Circuit Interrupter Cover Assembly</b>		
	Ground Fault Circuit Interrupter (Cover Assembly)	<b>ECSK-GFI</b>
	Receptacle and Cover Assembly	<b>ECSK-2023</b>



\* Approved for Group F with non-electrically conductive dusts.  
 ❖ CSA Certification only.

Plugs and Receptacles

PLUGS AND RECEPTACLES: HAZARDOUS LOCATION