

Industrial controls

Limit switches Foot switches

AC 1300

Limit switches - plastic



Limit switches - metal



Footswitches



ABB Limit switches Foot Switches

General information	II - VI
----------------------------------	---------

Limit Switches – Plastic casing, 30mm & 40mm

• Selection guide	1.2 – 1.3
• Description, implementation	1.4 – 1.5
• Selection	
30mm	1.6 – 1.8
40mm	1.9 – 1.12
• Technical data	
30mm	1.13 – 1.17
40mm	1.18 – 1.22

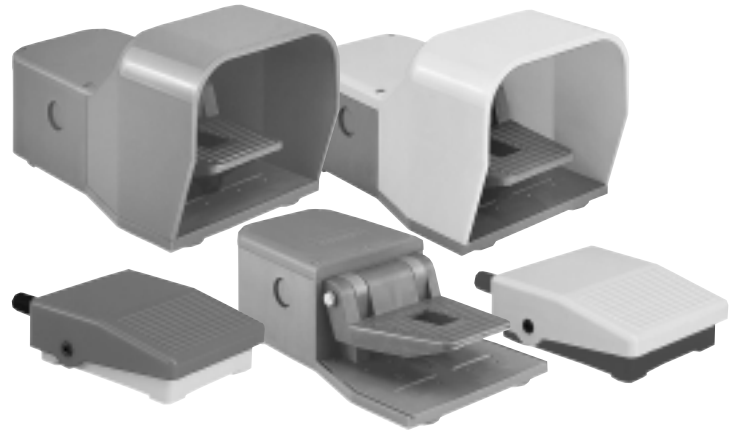
Limit Switches – Metal casing, 40mm & 60mm

• Selection guide	2.2 – 2.3
• Description, implementation	2.4 – 2.5
• Selection	
40mm	2.6 – 2.9
60mm	2.10 – 2.13
• Technical data	
40mm	2.14 – 2.20
60mm	2.21 – 2.28

Footswitches

• General information	3.2
• Mini-foot switches	3.3
• Footswitches with covers	3.4
• Technical data & approximate dimensions	3.5 - 3.7

Terms & conditions

• Information	4.1 – 4.2
• Standard compliance and approvals	4.8

Plastic limit switches

Metal limit switches

Footswitches

General information

Terminology

Plastic & metal casing types

Double insulation

Class II materials, according to IEC 536, are designed with double insulation. This measure consists in doubling the functional insulation with an additional layer of insulation so as to eliminate the risk of electric shock and thus not having to protect elsewhere. No conductive part of "double insulated" material should be connected to a protective conductor.

Positive opening operation

A control switch, with one or more break-contact elements, has a positive opening operation when the switch actuator ensures full contact opening of the break-contact. For the part of travel that separates the contacts, there must be a positive drive, with no resilient member (e.g. springs), between the moving contacts and the point of the actuator to which the actuating force is applied.

The positive opening operation does not deal with N.O. contacts.

Control switches with positive opening operation may be provided with either snap action or slow action contact elements. To use several contacts on the same control switch with positive opening operation, they must be electrically separated from each other, if not, only one may be used.

Every control switch with positive opening operation must be indelibly marked on the outside with the symbol: .

Snap action

Snap action contacts are characterized by a release position that is distinct from the operating position (differential travel). Snap breaking of moving contacts is independent of the switch actuator's speed and contributes to regular electric performance even for slow switch actuator speeds.

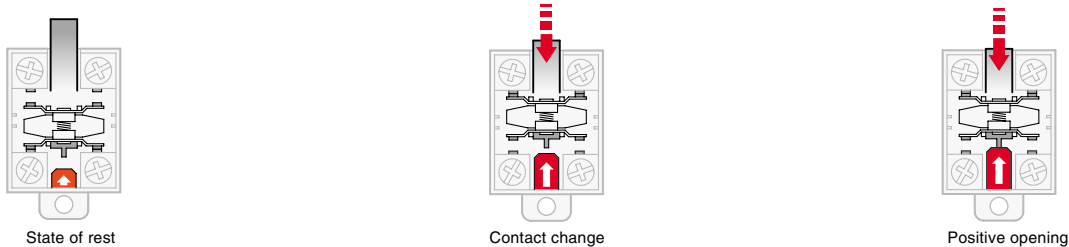

Slow action

Slow action contacts are characterized by a release position that is the same as the operating position. The switch actuator's speed directly conditions the travel speed of contacts.



Contact shape according to IEC 947-5-1.

Change-over contact elements with 4 terminals must be indelibly marked with the corresponding **Za** or **Zb** symbol as in the diagrams below.

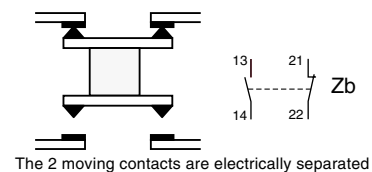
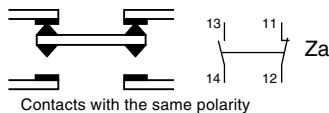

Utilization category

AC-15: switching of electromagnetic loads of electromagnets using an alternating current (>72 VA).

DC-13: switching of electromagnets using a direct current.

Terminals

Limit switches with metal casings must have a terminal, for a protective conductor, that is placed inside the casing very close to the cable inlet and must be indelibly marked.

Minimum actuation force/torque

The minimum amount of force/torque that is to be applied to the switch actuator to produce a change in contact position.

Minimum force/torque to achieve positive opening operation

The minimum amount of force/torque that is to be applied to the switch actuator to ensure positive opening operation of the N.C. contact.

General information

Travel and Operation Diagrams

Plastic & metal casing types

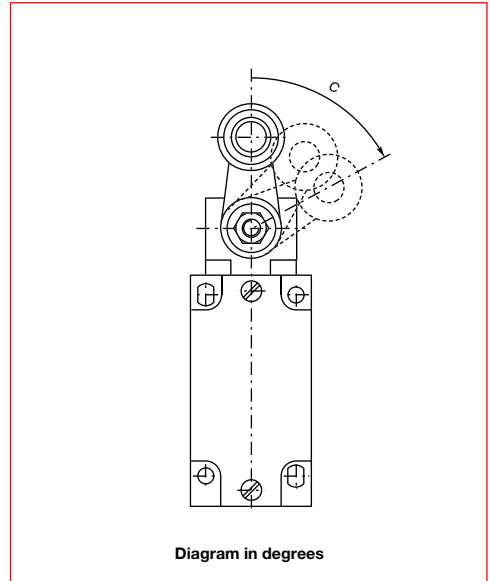
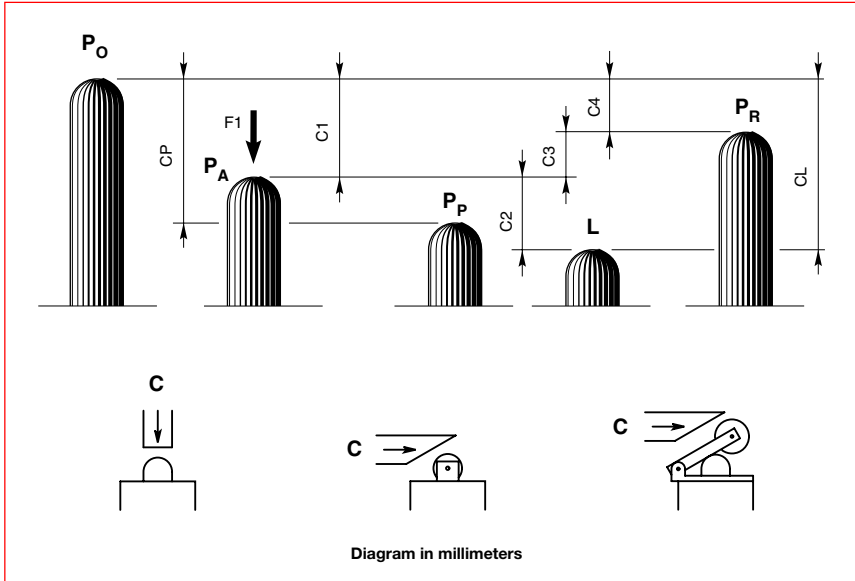

P_O Free position

position of the switch actuator when no external force is exerted on it.

P_A Operating position

position of the switch actuator, under the effect of force F₁, when the contacts leave their initial free position.

P_P Positive opening position

position of the switch actuator from which positive opening is ensured.

L Max. travel position

maximum acceptable travel position of the switch actuator under the effect of a force F₁.

P_R Release position

position of the switch actuator when the contacts return to their initial free position.

C₁ Pre-travel

distance between the free position P_O and the operating position P_A.

C_P Positive opening travel

minimum travel of the switch actuator, from the free position, to ensure positive opening operation of the normally closed contact.

C₂ Over-travel

distance between the operating position P_A and the max. travel position L.

C_L Max. travel

distance between the free position P_O and the max. travel position L.

C₃ Differential travel (C₁-C₄)

travel difference of the switch actuator between the operating position P_A and the release position P_R.

C₄ Release travel

distance between the release position P_R and the free position P_O.

Diagram for snap action contacts:

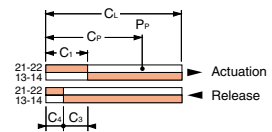
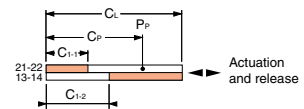

Diagram for non-overlapping slow action contacts:



Note: for slow action contacts, C₃ = 0, C₁₋₁ = pre-travel of contact 21-22, C₁₋₂ = pre-travel of contact 13-14.

Examples:

LS45M13B11
(snap action contacts)

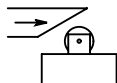
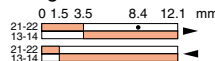

Diagram in millimetres/cam travel



LS45M41B11
(snap action contacts)

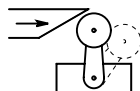
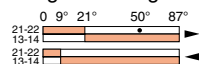

Diagram in degrees/lever rotation



LS45M11D11
(non-overlapping slow action contacts)

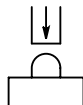
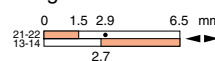

Diagram in millimetres/plunger travel



General information

Utilization precautions

Plain plunger

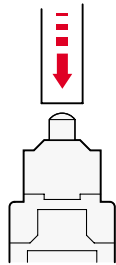

Correct

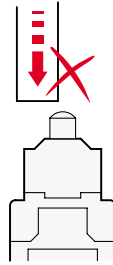

Incorrect

Roller plunger or roller lever

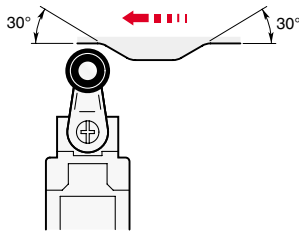

Correct

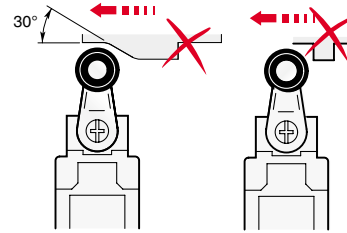

Incorrect

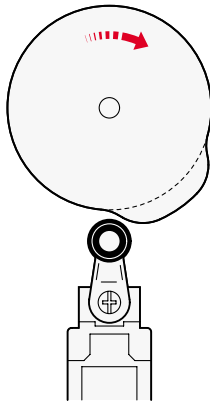

Correct

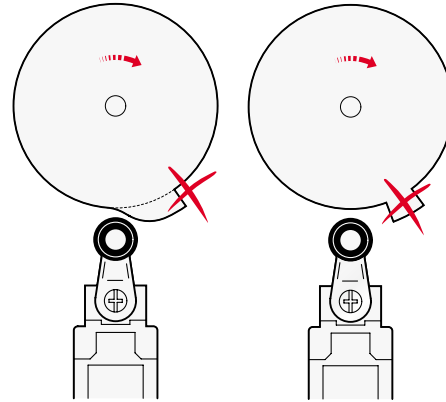

Incorrect

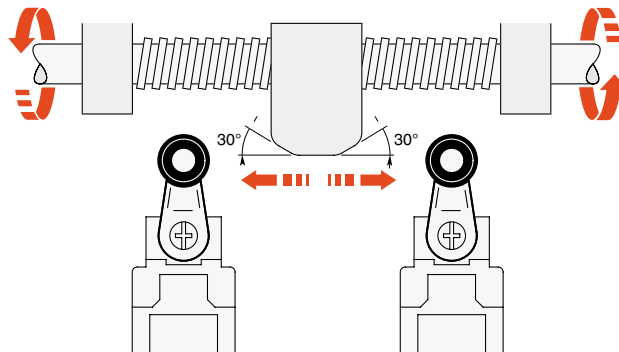

For a relatively slow movement of the switch actuator, a limit switch with a snap action contact block is preferred.

General information

EN 50047 standard

The European Committee for Electrotechnical Standardization (CENELEC), which groups together 18 European countries, publishes EN standards.

The present standard defines dimensions and mechanical data for limit switches (30 x 55mm).

A Shape

Roller lever operating heads

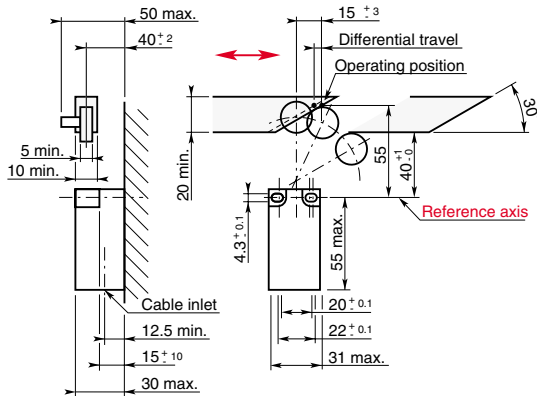

B Shape

Rounded plunger operating heads

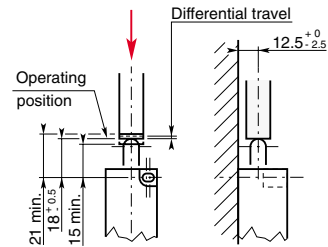

C Shape

Roller plunger operating heads

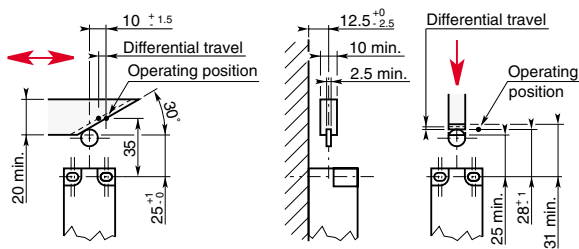

E Shape

Roller lever operating heads

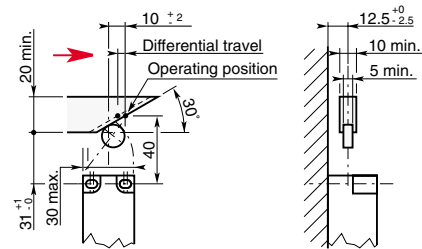

General information

EN 50041 standard

The European Committee for Electrotechnical Standardization (CENELEC), which groups together 18 European countries, publishes EN standards.

The present standard defines dimensions and mechanical data for limit switches (42.5 x 80 mm).

A Shape

Roller lever operating heads

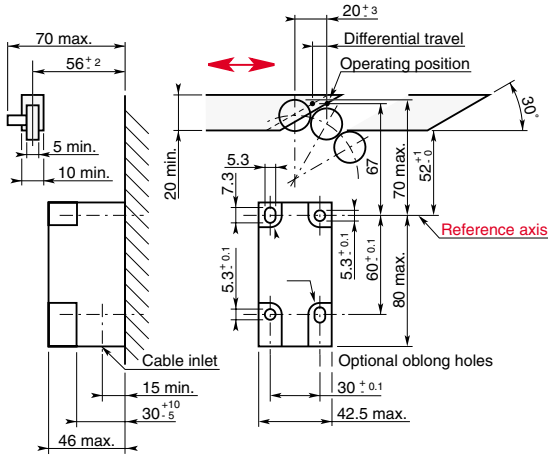

B Shape

Rounded plunger operating heads

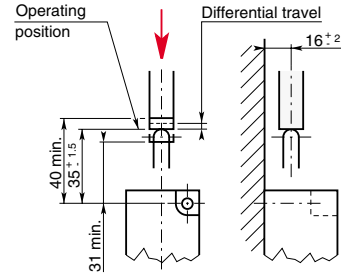

C Shape

Roller plunger operating heads

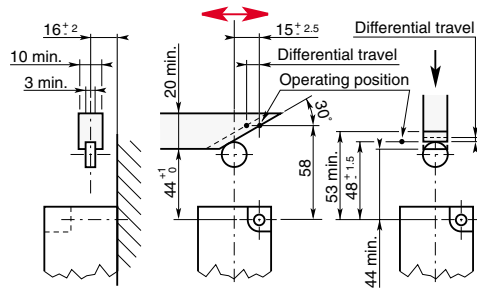

D Shape

Rod operating heads

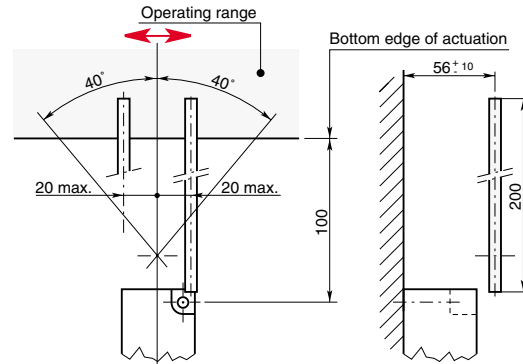

F Shape

Rounded lateral plunger operating heads

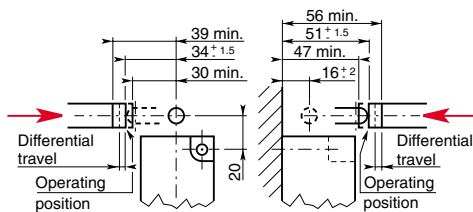

G Shape

Lateral roller plunger operating heads - Lateral actuation

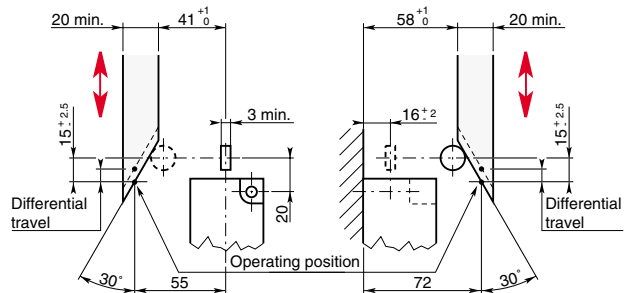

Lateral roller plunger operating heads - Front actuation

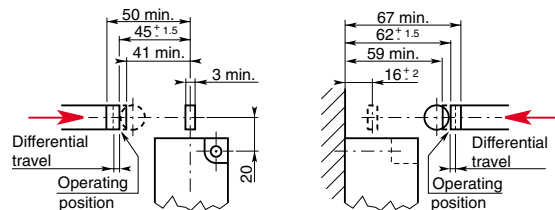



Limit Switches

Plastic casing, 30mm & 40mm

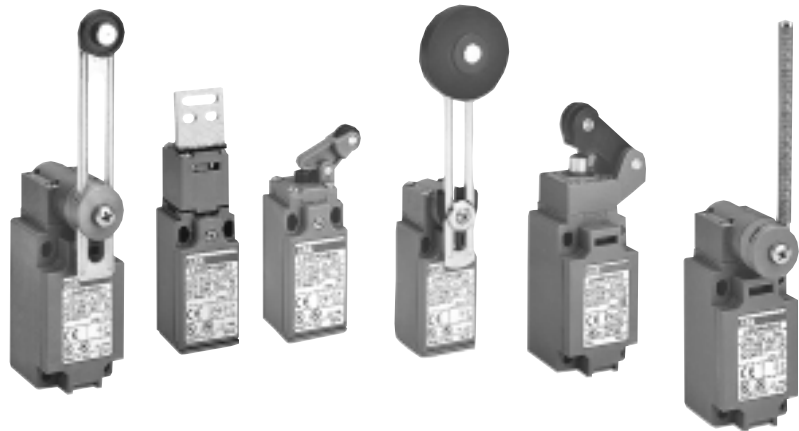

Plastic limit switches

Description

Limit switches are made of reinforced UL-V0 thermoplastic fiberglass, offer double insulation \square and a degree of protection of IP 65.

Casings come in 2 dimensions:

- 30mm width
 - LS31P
 - LS30P
 - LS35P
- 40mm width
 - LS40P
 - LS45P

UL Listed file #E191693

Applications

Easy to use, electromechanical limit switches offer specific qualities:

- Visible operation
- Able to switch strong currents (10 A conventional thermal current)
- Electrically separated contacts
- Precise operating points (consistency)
- Immune to electromagnetic disturbances

Limit switches used for these mechanical applications:

- Presence/absence
- Positioning and travel limit
- Objects passing/counting

Selection guide

Double insulation – plastic casing, IP65

30mm & 40mm

30mm width — LS30P, LS31P, LS35P

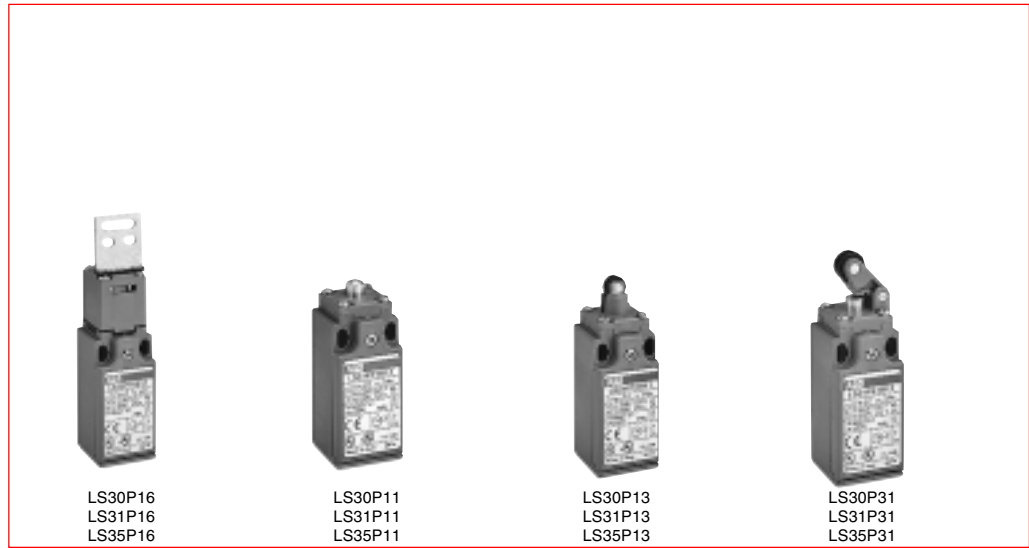

CENELEC conformity

—

EN 50 047

EN 50 047

EN 50 047

Actuating device and actuation type

Key translation movement

Plain plunger

Roller plunger

Roller lever

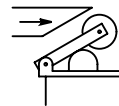
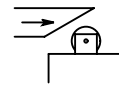
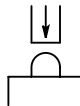
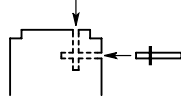

Positive contact opening



40mm width — LS40P, LS45P



CENELEC conformity

EN 50 041

EN 50 041

—

EN 50 041

Actuating device and actuation type

Plain plunger

Roller plunger

Roller lever

Roller lever

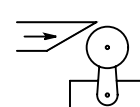
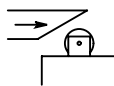
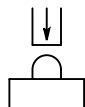

Positive contact opening



Selection guide

Double insulation — plastic casing IP65

30mm & 40mm

Plastic limit switches

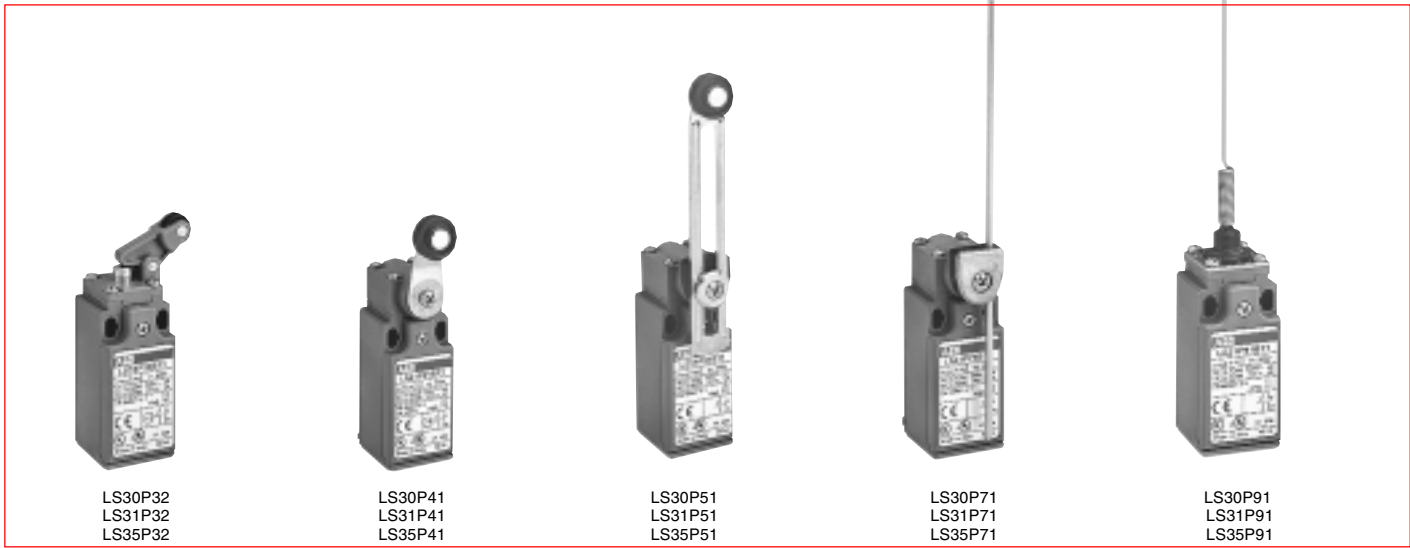

LS30P32
LS31P32
LS35P32

LS30P41
LS31P41
LS35P41

LS30P51
LS31P51
LS35P51

LS30P71
LS31P71
LS35P71

LS30P91
LS31P91
LS35P91

—
Roller lever

EN 50 047
Roller lever

—
Adjustable roller lever

—
Adjustable rod lever

—
Flexible rod

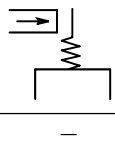
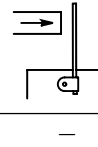
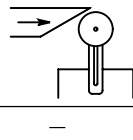
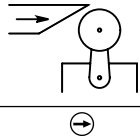
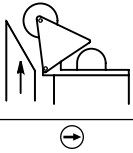

LS40P44
LS45P44

LS40P51
LS45P51

LS40P54
LS45P54

LS40P61
LS45P61

LS40P72
LS45P72

LS40P91
LS45P91

—
Roller lever

—
Adjustable roller levers

—
Adjustable flexible and rigid rod levers

EN 50 041

—
Flexible rod

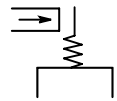
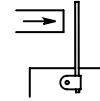
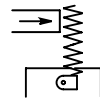
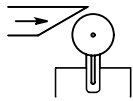
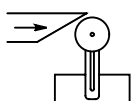
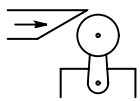

Description

LS30P, LS31P, LS35P, LS40P, LS45P Limit switches

Double insulation — plastic casing, IP65

Applications

Easy to use, electromechanical limit switches offer specific qualities:

- Visible operation
- Able to switch strong currents (10 A conventional thermal current)
- Electrically separated contacts
- Precise operating points (consistency)
- Immune to electromagnetic disturbances

Limit switches used for these mechanical applications:

- Presence/absence
- Positioning and travel limit
- Objects passing/counting

Description

Limit switches, which are made of reinforced UL-V0 thermoplastic fiberglass, offer double insulation \square and a degree of protection of IP 65. Casings come in 2 dimensions:

- 30mm width
 - LS31P
 - LS30P
 - LS35P
- 40mm width
 - LS40P
 - LS45P

Plastic limit switches

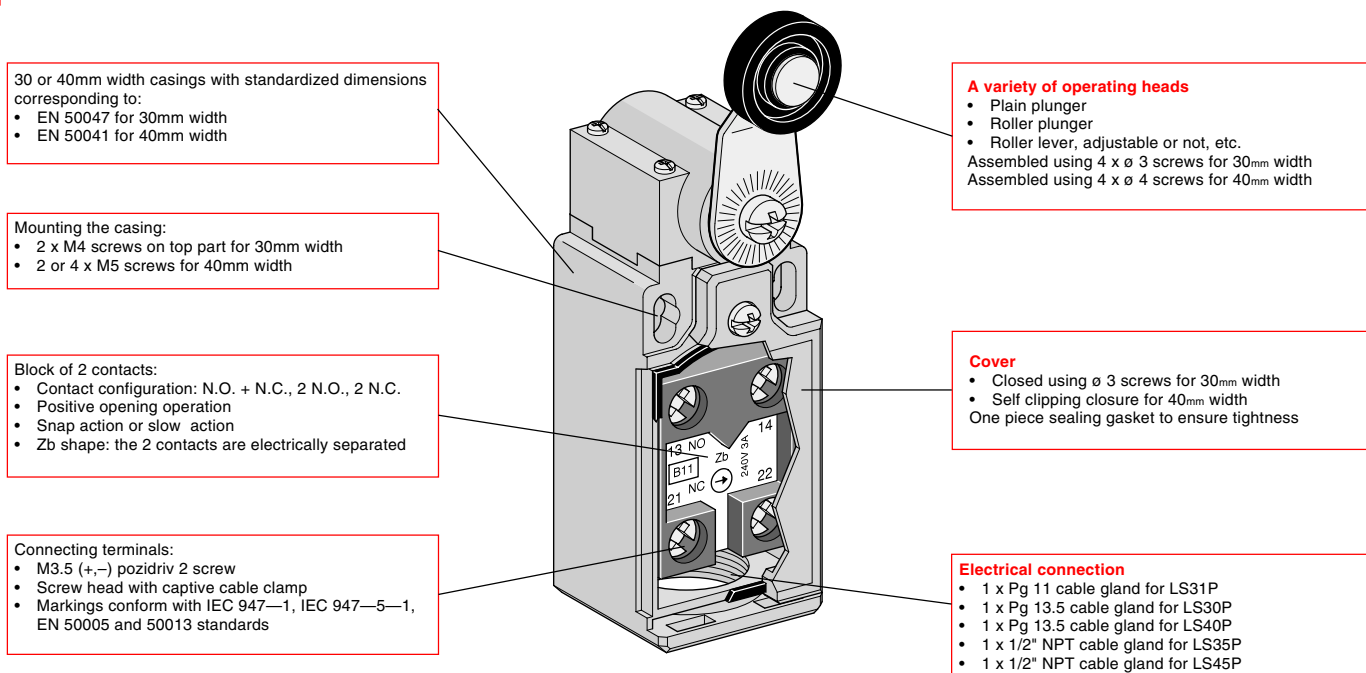

Catalog number explanation

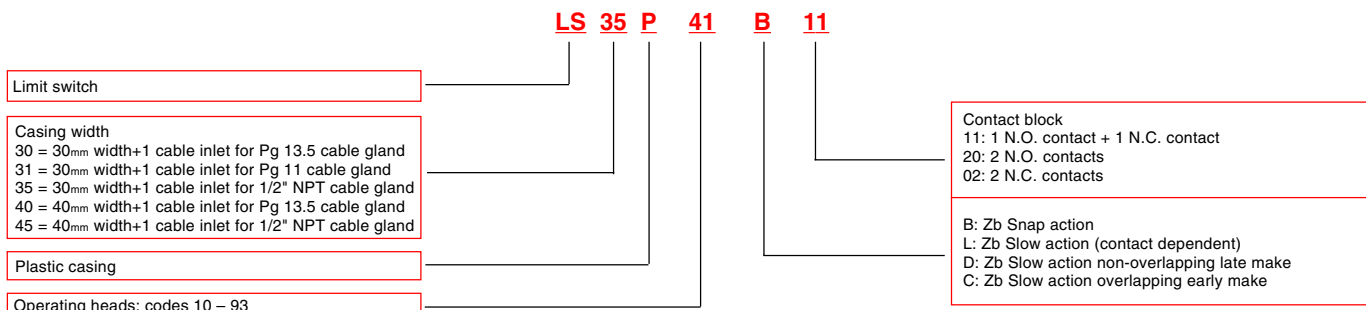

Implementation

LS30P, LS31P, LS35P, LS40P, LS45P limit switches
Double insulation — plastic casing, IP65

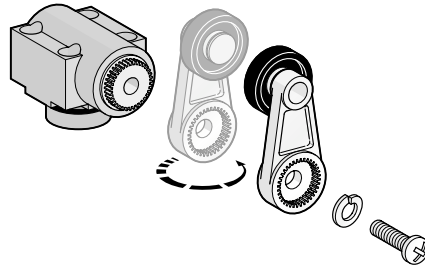

Lever round turning:
LS30P, LS31P, LS35P, LS40P & LS45P

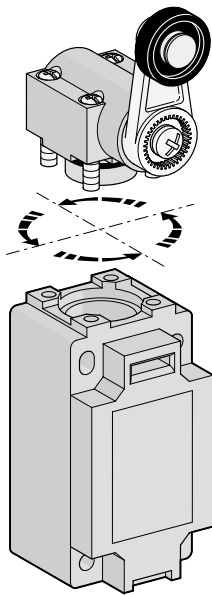

Head orientation:
LS30P, LS31P, LS35P, LS40P & LS45P

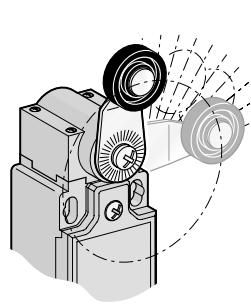

Free position adjustment
10 in 10° of lever:
LS30P, LS31P & LS35P

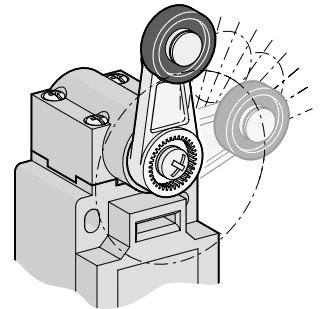

Free position adjustment
9 in 9° of lever:
LS40P, LS45P

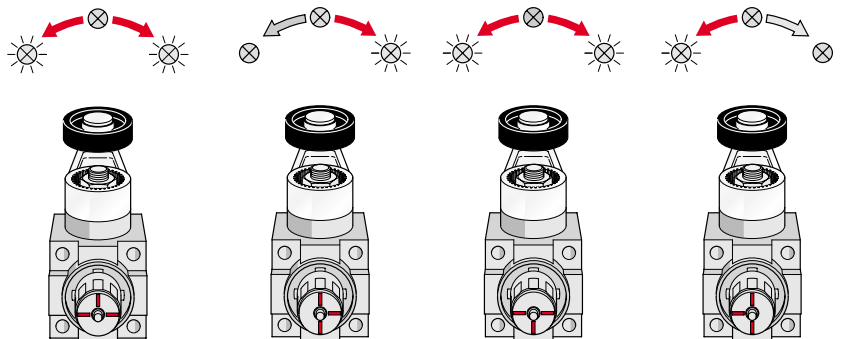
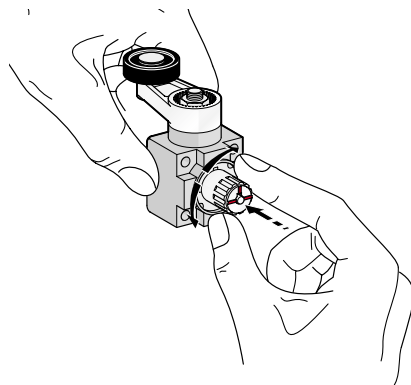

Operating mode selection only, LS40P & LS45P

Plastic casing, 30mm Double insulation, IP65



LS35P15B11



LS35P16B11



LS35P10B11



LS35P11B11









LS35P13B11



LS35P30B11

Plastic limit switches

LS35P

Contact blocks						Unit weight in kg Packing 1 piece	Catalog number	List price
Snap action 	Non-overlapping slow action 	Overlapping slow action 	Slow action 	Slow action 	Snap action 			
Right angle key								
1	—	—	—	—	—	0.085	LS35P15B11	\$ 31
—	1	—	—	—	—	0.085	LS35P15D11	33
—	—	1	—	—	—	0.085	LS35P15C11	34
—	—	—	1	—	—	0.085	LS35P15L02	34
—	—	—	—	1	—	0.085	LS35P15L20	34
—	—	—	—	—	1	0.085	LS35P15B02	34
Straight key								
1	—	—	—	—	—	0.085	LS35P16B11	33
—	1	—	—	—	—	0.085	LS35P16D11	35
—	—	1	—	—	—	0.085	LS35P16C11	36
—	—	—	1	—	—	0.085	LS35P16L02	36
—	—	—	—	1	—	0.085	LS35P16L20	36
—	—	—	—	—	1	0.085	LS35P16B02	36
Thermoplastic plain plunger								
1	—	—	—	—	—	0.065	LS35P10B11	22
—	1	—	—	—	—	0.065	LS35P10D11	23
—	—	1	—	—	—	0.065	LS35P10C11	24
—	—	—	1	—	—	0.065	LS35P10L02	24
—	—	—	—	1	—	0.065	LS35P10L20	24
—	—	—	—	—	1	0.065	LS35P10B02	24
Steel plain plunger								
1	—	—	—	—	—	0.070	LS35P11B11	22
—	1	—	—	—	—	0.070	LS35P11D11	23
—	—	1	—	—	—	0.070	LS35P11C11	24
—	—	—	1	—	—	0.070	LS35P11L02	24
—	—	—	—	1	—	0.070	LS35P11L20	24
—	—	—	—	—	1	0.070	LS35P11B02	24
Plastic roller plunger								
1	—	—	—	—	—	0.070	LS35P13B11	25
—	1	—	—	—	—	0.070	LS35P13D11	26
—	—	1	—	—	—	0.070	LS35P13C11	27
—	—	—	1	—	—	0.070	LS35P13L02	27
—	—	—	—	1	—	0.070	LS35P13L20	27
—	—	—	—	—	1	0.070	LS35P13B02	27
Plastic roller lever on plastic plunger								
1	—	—	—	—	—	0.065	LS35P30B11	24
—	1	—	—	—	—	0.065	LS35P30D11	25
—	—	1	—	—	—	0.065	LS35P30C11	26
—	—	—	1	—	—	0.065	LS35P30L02	26
—	—	—	—	1	—	0.065	LS35P30L20	26
—	—	—	—	—	1	0.065	LS35P30B02	26





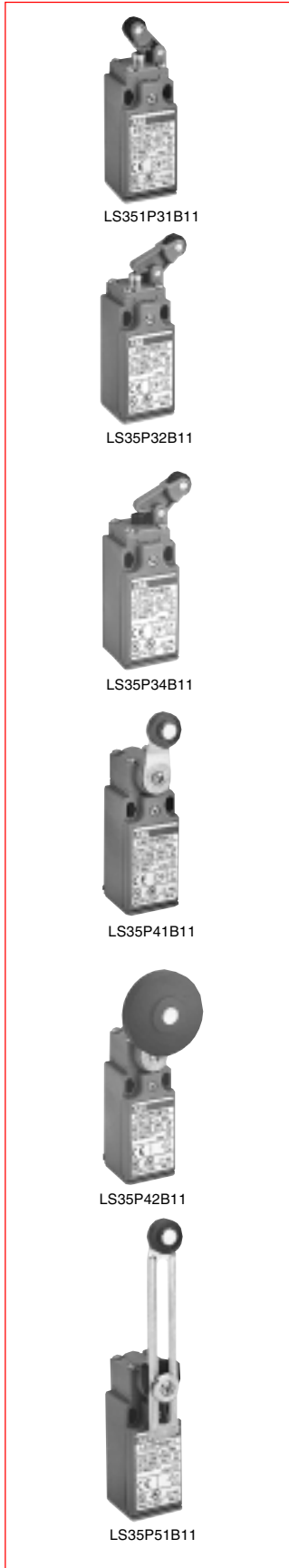

Alternative threads

- For pg.11 cable gland, replace "35" with "31" in the catalog number.
- For pg.13.5 cable gland, replace "35" with "30" in the catalog number.

Plastic casing, 30mm Double insulation, IP65



LS35P

Contact blocks						Unit weight in kg Packing 1 piece	Catalog number	List price
Snap action  Zb	Non-overlapping slow action  Zb	Overlapping slow action  Zb	Slow action  Zb	Slow action  Zb	Snap action  Zb			
Plastic roller lever on steel plunger								
1	—	—	—	—	—	0.070	LS35P31B11	\$ 25
—	1	—	—	—	—	0.070	LS35P31D11	
—	—	1	—	—	—	0.070	LS35P31C11	
—	—	—	1	—	—	0.070	LS35P31L02	
—	—	—	—	1	—	0.070	LS35P31L20	
—	—	—	—	—	1	0.070	LS35P31B02	
Plastic roller lever on steel plunger								
1	—	—	—	—	—	0.075	LS35P32B11	24
—	1	—	—	—	—	0.075	LS35P32D11	
—	—	1	—	—	—	0.075	LS35P32C11	
—	—	—	1	—	—	0.075	LS35P32L02	
—	—	—	—	1	—	0.075	LS35P32L20	
—	—	—	—	—	1	0.075	LS35P32B02	
Plastic roller lever on plastic plunger								
1	—	—	—	—	—	0.070	LS35P34B11	25
—	1	—	—	—	—	0.070	LS35P34D11	
—	—	1	—	—	—	0.070	LS35P34C11	
—	—	—	1	—	—	0.070	LS35P34L02	
—	—	—	—	1	—	0.070	LS35P34L20	
—	—	—	—	—	1	0.070	LS35P34B02	
ø 18 polyamide roller lever								
1	—	—	—	—	—	0.090	LS35P41B11	26
—	1	—	—	—	—	0.090	LS35P41D11	
—	—	1	—	—	—	0.090	LS35P41C11	
—	—	—	1	—	—	0.090	LS35P41L02	
—	—	—	—	1	—	0.090	LS35P41L20	
—	—	—	—	—	1	0.090	LS35P41B02	
ø 45 rubber roller lever								
1	—	—	—	—	—	0.120	LS35P42B11	27
—	1	—	—	—	—	0.120	LS35P42D11	
—	—	1	—	—	—	0.120	LS35P42C11	
—	—	—	1	—	—	0.120	LS35P42L02	
—	—	—	—	1	—	0.120	LS35P42L20	
—	—	—	—	—	1	0.120	LS35P42B02	
Adjustable ø 18 polyamide roller lever								
1	—	—	—	—	—	0.100	LS35P51B11	27
—	1	—	—	—	—	0.100	LS35P51D11	
—	—	1	—	—	—	0.100	LS35P51C11	
—	—	—	1	—	—	0.100	LS35P51L02	
—	—	—	—	1	—	0.100	LS35P51L20	
—	—	—	—	—	1	0.100	LS35P51B02	

Alternative threads

- For pg.11 cable gland, replace "35" with "31" in the catalog number.
- For pg.13.5 cable gland, replace "35" with "30" in the catalog number.

Plastic casing, 30mm Double insulation, IP65

Plastic limit switches



LS35P52B11



LS35P71B11



LS35P72B11









LS35P91B11



LS35P92B11

LS35P

Contact blocks						Unit weight in kg Packing 1 piece	Catalog number	List price
Snap action 	Non-overlapping slow action 	Overlapping slow action 	Slow action 	Slow action 	Snap action 			
Adjustable ø 45 rubber roller lever								
1	—	—	—	—	—	0.130	LS35P52B11	\$ 28
—	1	—	—	—	—	0.130	LS35P52D11	30
—	—	1	—	—	—	0.130	LS35P52C11	30
—	—	—	1	—	—	0.130	LS35P52L02	30
—	—	—	—	1	—	0.130	LS35P52L20	30
—	—	—	—	—	1	0.130	LS35P52B02	30
Adjustable ø 3 stainless steel rod lever								
1	—	—	—	—	—	0.100	LS35P71B11	27
—	1	—	—	—	—	0.100	LS35P71D11	28
—	—	1	—	—	—	0.100	LS35P71C11	29
—	—	—	1	—	—	0.100	LS35P71L02	29
—	—	—	—	1	—	0.100	LS35P71L20	29
—	—	—	—	—	1	0.100	LS35P71B02	29
Adjustable ø 3 fiberglass rod lever								
1	—	—	—	—	—	0.100	LS35P72B11	27
—	1	—	—	—	—	0.100	LS35P72D11	28
—	—	1	—	—	—	0.100	LS35P72C11	29
—	—	—	1	—	—	0.100	LS35P72L02	29
—	—	—	—	1	—	0.100	LS35P72L20	29
—	—	—	—	—	1	0.100	LS35P72B02	29
Spring rod								
1	—	—	—	—	—	0.080	LS35P91B11	25
—	1	—	—	—	—	0.080	LS35P91D11	27
—	—	1	—	—	—	0.080	LS35P91C11	27
—	—	—	1	—	—	0.080	LS35P91L02	27
—	—	—	—	1	—	0.080	LS35P91L20	27
—	—	—	—	—	1	0.080	LS35P91B02	27
Flexible rod with insulated end								
1	—	—	—	—	—	0.080	LS35P92B11	25
—	1	—	—	—	—	0.080	LS35P92D11	27
—	—	1	—	—	—	0.080	LS35P92C11	27
—	—	—	1	—	—	0.080	LS35P92L02	27
—	—	—	—	1	—	0.080	LS35P92L20	27
—	—	—	—	—	1	0.080	LS35P92B02	27

Alternative threads

- For pg.11 cable gland, replace "35" with "31" in the catalog number.
- For pg.13.5 cable gland, replace "35" with "30" in the catalog number.

Plastic casing, 40mm
Double insulation, IP 65
1 Cable inlet for 1/2" NPT cable gland

LS45P



LS45P11B11



LS45P12B11









LS45P13B11



LS45P31B11



LS45P33B11

Contact blocks						Unit weight in kg Packing 1 piece	Catalog number	List price
Snap action  Zb	Non-overlapping slow action  Zb	Overlapping slow action  Zb	Slow action  Zb	Slow action  Zb	Snap action  Zb			
Steel plain plunger								
1	—	—	—	—	—	0.140	LS45P11B11	\$ 30
—	1	—	—	—	—	0.140	LS45P11D11	32
—	—	1	—	—	—	0.140	LS45P11C11	33
—	—	—	1	—	—	0.140	LS45P11L02	33
—	—	—	—	1	—	0.140	LS45P11L20	33
—	—	—	—	—	1	0.140	LS45P11B02	33
Steel ball plunger								
1	—	—	—	—	—	0.140	LS45P12B11	32
—	1	—	—	—	—	0.140	LS45P12D11	34
—	—	1	—	—	—	0.140	LS45P12C11	35
—	—	—	1	—	—	0.140	LS45P12L02	35
—	—	—	—	1	—	0.140	LS45P12L20	35
—	—	—	—	—	1	0.140	LS45P12B02	35
Steel roller plunger								
1	—	—	—	—	—	0.145	LS45P13B11	37
—	1	—	—	—	—	0.145	LS45P13D11	39
—	—	1	—	—	—	0.145	LS45P13C11	40
—	—	—	1	—	—	0.145	LS45P13L02	40
—	—	—	—	1	—	0.145	LS45P13L20	40
—	—	—	—	—	1	0.145	LS45P13B02	40
Polyamide roller lever								
1	—	—	—	—	—	0.175	LS45P31B11	34
—	1	—	—	—	—	0.175	LS45P31D11	36
—	—	1	—	—	—	0.175	LS45P31C11	37
—	—	—	1	—	—	0.175	LS45P31L02	37
—	—	—	—	1	—	0.175	LS45P31L20	37
—	—	—	—	—	1	0.175	LS45P31B02	37
Stainless steel roller lever								
1	—	—	—	—	—	0.185	LS45P32B11	39
—	1	—	—	—	—	0.185	LS45P32D11	42
—	—	1	—	—	—	0.185	LS45P32C11	43
—	—	—	1	—	—	0.185	LS45P32L02	43
—	—	—	—	1	—	0.185	LS45P32L20	43
—	—	—	—	—	1	0.185	LS45P32B02	43
Ball bearing roller lever								
1	—	—	—	—	—	0.185	LS45P33B11	36
—	1	—	—	—	—	0.185	LS45P33D11	38
—	—	1	—	—	—	0.185	LS45P33C11	39
—	—	—	1	—	—	0.185	LS45P33L02	39
—	—	—	—	1	—	0.185	LS45P33L20	39
—	—	—	—	—	1	0.185	LS45P33B02	39

Alternative threads

- For pg.13.5 cable gland, replace "45" with "40" in the catalog number.

Plastic limit switches

Plastic casing, 40mm
Double insulation, IP 65,
1 Cable inlet for 1/2" NPT cable gland



LS45P41B11



LS45P43B11



LS45P44B11

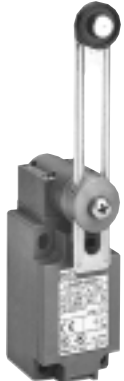

LS45P51B11

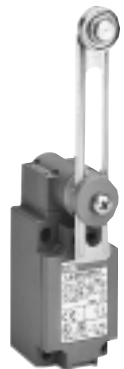

LS45P52B11

LS45P

Contact blocks						Unit weight in kg Packing 1 piece	Catalog number	List price
Snap action	Non-overlapping slow action	Overlapping slow action	Slow action	Slow action	Snap action			
Zb	Zb	Zb	Zb	Zb	Zb			
ø 22 polyamide roller lever								
1	—	—	—	—	—	0.185	LS45P41B11	\$ 39
—	1	—	—	—	—	0.185	LS45P41D11	42
—	—	1	—	—	—	0.185	LS45P41C11	43
—	—	—	1	—	—	0.185	LS45P41L02	43
—	—	—	—	1	—	0.185	LS45P41L20	43
—	—	—	—	—	1	0.185	LS45P41B02	43
ø 22 stainless steel roller lever								
1	—	—	—	—	—	0.195	LS45P42B11	47
—	1	—	—	—	—	0.195	LS45P42D11	50
—	—	1	—	—	—	0.195	LS45P42C11	52
—	—	—	1	—	—	0.195	LS45P42L02	52
—	—	—	—	1	—	0.195	LS45P42L20	52
—	—	—	—	—	1	0.195	LS45P42B02	52
ø 22 ball – bearing roller lever								
1	—	—	—	—	—	0.195	LS45P43B11	42
—	1	—	—	—	—	0.195	LS45P43D11	45
—	—	1	—	—	—	0.195	LS45P43C11	47
—	—	—	1	—	—	0.195	LS45P43L02	47
—	—	—	—	1	—	0.195	LS45P43L20	47
—	—	—	—	—	1	0.195	LS45P43B02	47
ø 45 rubber roller lever								
1	—	—	—	—	—	0.205	LS45P44B11	41
—	1	—	—	—	—	0.205	LS45P44D11	44
—	—	1	—	—	—	0.205	LS45P44C11	45
—	—	—	1	—	—	0.205	LS45P44L02	45
—	—	—	—	1	—	0.205	LS45P44L20	45
—	—	—	—	—	1	0.205	LS45P44B02	45
Adjustable ø 22 polyamide roller lever								
1	—	—	—	—	—	0.190	LS45P51B11	39
—	1	—	—	—	—	0.190	LS45P51D11	42
—	—	1	—	—	—	0.190	LS45P51C11	43
—	—	—	1	—	—	0.190	LS45P51L02	43
—	—	—	—	1	—	0.190	LS45P51L20	43
—	—	—	—	—	1	0.190	LS45P51B02	43
Adjustable ø 22 stainless steel roller lever								
1	—	—	—	—	—	0.200	LS45P52B11	47
—	1	—	—	—	—	0.200	LS45P52D11	50
—	—	1	—	—	—	0.200	LS45P52C11	52
—	—	—	1	—	—	0.200	LS45P52L02	52
—	—	—	—	1	—	0.200	LS45P52L20	52
—	—	—	—	—	1	0.200	LS45P52B02	52

Alternative threads

- For pg.13.5 cable gland, replace "45" with "40" in the catalog number.

Plastic limit switches

Plastic casing, 40mm
Double insulation, IP 65
1 Cable inlet for 1/2" NPT cable gland



LS45P

Contact blocks						Unit weight in kg Packing 1 piece	Catalog number	List price
Snap action Zb I	Non-overlapping slow action Zb I	Overlapping slow action Zb I	Slow action Zb I	Slow action Zb I	Snap action Zb I			
Adjustable ø 22 ball – bearing roller lever								
1	—	—	—	—	—	0.200	LS45P53B11	\$ 43
—	1	—	—	—	—	0.200	LS45P53D11	46
—	—	1	—	—	—	0.200	LS45P53C11	47
—	—	—	1	—	—	0.200	LS45P53L02	47
—	—	—	—	1	—	0.200	LS45P53L20	47
—	—	—	—	—	1	0.200	LS45P53B02	47
Adjustable ø 45 rubber roller lever								
1	—	—	—	—	—	0.200	LS45P54B11	41
—	1	—	—	—	—	0.200	LS45P54D11	44
—	—	1	—	—	—	0.200	LS45P54C11	45
—	—	—	1	—	—	0.200	LS45P54L02	45
—	—	—	—	1	—	0.200	LS45P54L20	45
—	—	—	—	—	1	0.200	LS45P54B02	45
Flexible lever with insulated end								
1	—	—	—	—	—	0.190	LS45P61B11	41
—	1	—	—	—	—	0.190	LS45P61D11	44
—	—	1	—	—	—	0.190	LS45P61C11	46
—	—	—	1	—	—	0.190	LS45P61L02	46
—	—	—	—	1	—	0.190	LS45P61L20	46
—	—	—	—	—	1	0.190	LS45P61B02	46
Coil spring lever								
1	—	—	—	—	—	0.190	LS45P62B11	41
—	1	—	—	—	—	0.190	LS45P62D11	44
—	—	1	—	—	—	0.190	LS45P62C11	45
—	—	—	1	—	—	0.190	LS45P62L02	45
—	—	—	—	1	—	0.190	LS45P62L20	45
—	—	—	—	—	1	0.190	LS45P62B02	45
Adjustable ø 3 stainless steel rod lever								
1	—	—	—	—	—	0.185	LS45P71B11	38
—	1	—	—	—	—	0.185	LS45P71D11	41
—	—	1	—	—	—	0.185	LS45P71C11	43
—	—	—	1	—	—	0.185	LS45P71L02	43
—	—	—	—	1	—	0.185	LS45P71L20	43
—	—	—	—	—	1	0.185	LS45P71B02	43
Adjustable ø 6 polyamide rod lever								
1	—	—	—	—	—	0.185	LS45P72B11	38
—	1	—	—	—	—	0.185	LS45P72D11	41
—	—	1	—	—	—	0.185	LS45P72C11	42
—	—	—	1	—	—	0.185	LS45P72L02	42
—	—	—	—	1	—	0.185	LS45P72L20	42
—	—	—	—	—	1	0.185	LS45P72B02	42

Alternative threads

- For pg.13.5 cable gland, replace "45" with "40" in the catalog number.

Plastic limit switches

Plastic casing, 40mm
Double insulation, IP 65
1 Cable inlet for 1/2" NPT cable gland

Plastic limit switches



LS45P91B11









LS45P92B11



LS45P93B11

LS45P

Contact blocks						Unit weight in kg Packing 1 piece	Catalog number	List price
Snap action 	Non-overlapping slow action 	Overlapping slow action 	Slow action 	Slow action 	Snap action 			
Spring rod								
1	—	—	—	—	—	0.135	LS45P91B11	\$ 32
—	1	—	—	—	—	0.135	LS45P91D11	34
—	—	1	—	—	—	0.135	LS45P91C11	35
—	—	—	1	—	—	0.135	LS45P91L02	35
—	—	—	—	1	—	0.135	LS45P91L20	35
—	—	—	—	—	1	0.135	LS45P91B02	35
Flexible rod with insulated end								
1	—	—	—	—	—	0.140	LS45P92B11	35
—	1	—	—	—	—	0.140	LS45P92D11	37
—	—	1	—	—	—	0.140	LS45P92C11	38
—	—	—	1	—	—	0.140	LS45P92L02	38
—	—	—	—	1	—	0.140	LS45P92L20	38
—	—	—	—	—	1	0.140	LS45P92B02	38
Coil spring rod								
1	—	—	—	—	—	0.145	LS45P93B11	33
—	1	—	—	—	—	0.145	LS45P93D11	35
—	—	1	—	—	—	0.145	LS45P93C11	37
—	—	—	1	—	—	0.145	LS45P93L02	37
—	—	—	—	1	—	0.145	LS45P93L20	37
—	—	—	—	—	1	0.145	LS45P93B02	37

Alternative threads

- For pg.13.5 cable gland, replace "45" with "40" in the catalog number.

Technical data

Plastic casing

Plastic limit switches

General technical data

		Plastic casing	Metal casing
Standards		Devices conform with international IEC 947-5-1 and European EN 60 947-5-1 standards	
Certifications - Approvals		UL & CSA	
Air temperature near the device (IEC)			
– during operation	°C	– 25 ... + 70	– 25 ... + 70
– for storage	°C	– 30 ... + 80	– 30 ... + 80
Climatic withstand		According to IEC 68-2-3 and salty mist according to IEC 68-2-11	
Mounting positions		All positions are authorized	
Shock withstand (according to IEC 68-2-27 and EN 60 068-2-27)		50g [Ⓢ] (1/2 sinusoidal shock for 11 ms) no change in contact position	
Resistance to vibrations (acc. to IEC 68-2-6 and EN 60 068-2-6)		25g (10 – 500 Hz) no change in position of contacts greater than 100μs	
Protection against electrical shocks (acc. to IEC 536)		Class II	Class I
Degree of protection (according to IEC 529 and EN 60 529)		IP 65	IP 66
Consistency (measured over 1 million operations)		0.1 mm (upon closing point)	0.05 mm (upon closing point)
Minimum actuation speed	m/s	Slow action contacts 0.060 / Snap action contacts 0.001	
Electrical Data			
Rated insulation voltage U_i - according to IEC 947-1 and EN 60-947-1 - according to UL 508 and CSA C22-2 n° 14		500 V (degree of pollution 3) A 600, Q 600	
Rated impulse withstand voltage U_{imp} (according to IEC 947-1 and EN 60 947-1)	kV	6	
Conventional free air thermal current I_{th} (according to IEC 947-5-1) $q \leq 40$ °C	A	10	
Short-circuit protection $U_e \leq 500$ V a.c. - gG (gl) type fuses	A	10	
Rated operational current I_e / AC-15 (according to IEC 947-5-1)			
	24 V - 50/60 Hz	A	10
	130 V - 50/60 Hz	A	5.5
	230 V - 50/60 Hz	A	3.1
	240 V - 50/60 Hz	A	3
	400 V - 50/60 Hz	A	1.8
I_e / DC-13 (according to IEC 947-5-1)			
	24 V - d.c.	A	2.8
	110 V - d.c.	A	0.6
	250 V - d.c.	A	0.27
Switching frequency	Cycles/h	3600	
Load factor		0.5	
Resistance between contacts	mW	25	
Connecting terminals		M3.5 (+, -) pozidriv 2 screw with cable clamp	
Terminal for protective conductor		-	M3.5 (+, -) pozidriv 2 screw with cable clamp
Connecting capacity	1 or 2 x mm ²	0.5 ... 2.5	
Terminal marking		According to EN 50 013	
Mechanical durability	Millions of operations	$\left. \begin{matrix} 15 \\ 10 \\ 5 \\ > 1 \end{matrix} \right\} \text{LS} \left \begin{matrix} 30 \\ 31 \\ 40 \end{matrix} \right. \text{P} \left\{ \begin{matrix} 10 - 12; 30 - 34 \\ 13; 41 - 44; 51 - 54; 61 - 72 \\ 91 - 93 \\ 15; 16 \end{matrix} \right.$	$\left. \begin{matrix} 30 \\ 25 \\ 10 \end{matrix} \right\} \text{LS} \left \begin{matrix} 40 \\ 60 \end{matrix} \right. \text{M} \left\{ \begin{matrix} 11 - 13; 21 - 23; 31 - 33 \\ 41 - 44; 51 - 54; 61 - 72 \\ 91 - 93 \end{matrix} \right.$
Electrical durability (according to IEC 947-5-1)		Utilization categories AC-15 and DC-13 (Load factor of 0.5 according to curves below)	

AC-15 — Snap action

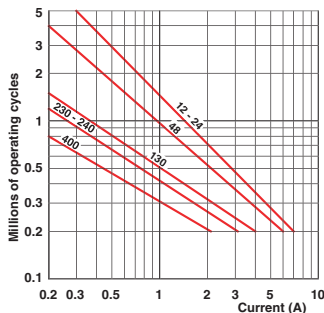

AC-15 — Slow action

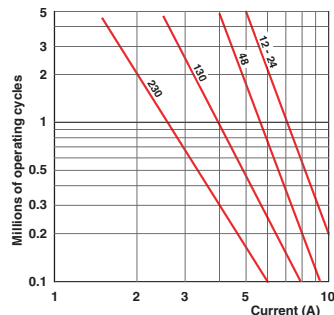

DC-13	Snap action	Slow action
	Power breaking for a durability of 5 million operating cycles	
Voltage	24 V	12 W
Voltage	48 V	9 W
Voltage	110 V	6 W

[Ⓢ] except for LS30/31/35 (P42): 25g

Technical data, 30mm

Double insulation, plastic casing IP 65

1 Cable inlet for 1/2" NPT cable gland

30° Cam Translat.

30° Unidirectional Cam Translation Movement

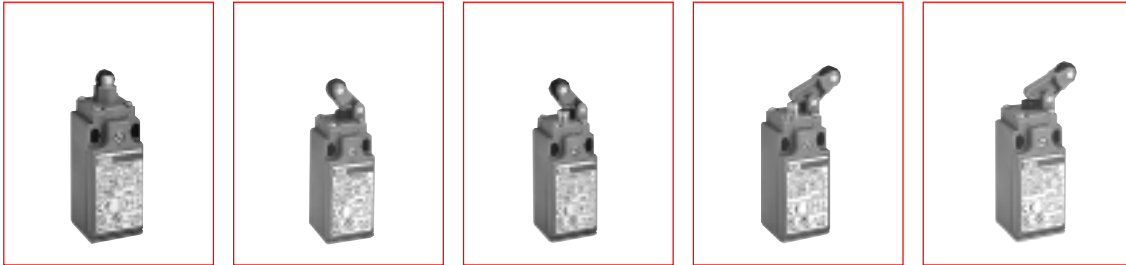

Plastic roller plunger	Plastic roller lever on plastic plunger	Plastic roller lever on steel plunger	Plastic roller lever on steel plunger	Plastic roller lever on plastic plunger
EN 50 047	EN 50 047	EN 50 047		
0.3	1	1	1	1
12	7	7	3	3
41	24	24	24	24

LS35P13B11 21-22, 13-14, 13-14	LS35P30B11 21-22, 13-14, 21-22, 13-14	LS35P31B11 21-22, 13-14, 21-22, 13-14	LS35P32B11 21-22, 13-14, 21-22, 13-14	LS35P34B11 21-22, 13-14, 21-22, 13-14
LS35P13D11 21-22, 13-14, 4.7	LS35P30D11 21-22, 13-14, 10.1	LS35P31D11 21-22, 13-14, 10.1	LS35P32D11 21-22, 13-14, 8.8	LS35P34D11 21-22, 13-14, 8.8
LS35P13C11 21-22, 13-14, 2.6	LS35P30C11 21-22, 13-14, 5.6	LS35P31C11 21-22, 13-14, 5.6	LS35P32C11 21-22, 13-14, 4.9	LS35P34C11 21-22, 13-14, 4.9
LS35P13L02 11-12, 21-22	LS35P30L02 11-12, 21-22	LS35P31L02 11-12, 21-22	LS35P32L02 11-12, 21-22	LS35P34L02 11-12, 21-22
LS35P13L20 13-14, 23-24	LS35P30L20 13-14, 23-24	LS35P31L20 13-14, 23-24	LS35P32L20 13-14, 23-24	LS35P34L20 13-14, 23-24
LS35P13B02 11-12, 21-22, 11-12, 21-22	LS35P30B02 11-12, 21-22, 11-12, 21-22	LS35P31B02 11-12, 21-22, 11-12, 21-22	LS35P32B02 11-12, 21-22, 11-12, 21-22	LS35P34B02 11-12, 21-22, 11-12, 21-22
0.070	0.065	0.070	0.075	0.070

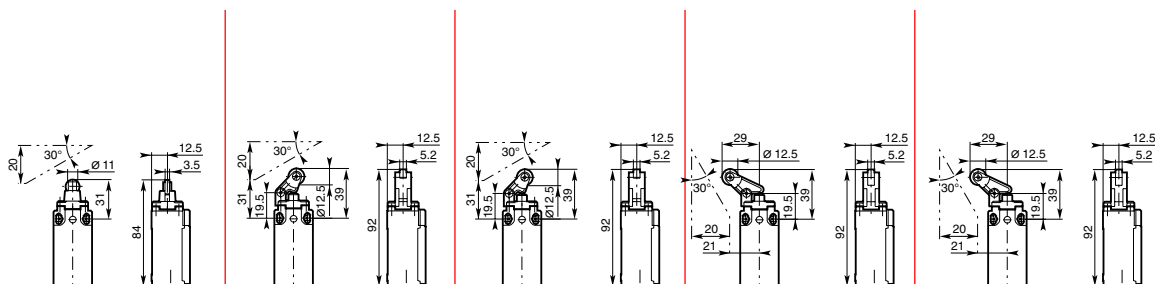

Technical data, 30mm

Double insulation, plastic casing, IP 65

1 Cable inlet for 1/2" NPT cable gland

Movement to be detected

30° Cam translation movement

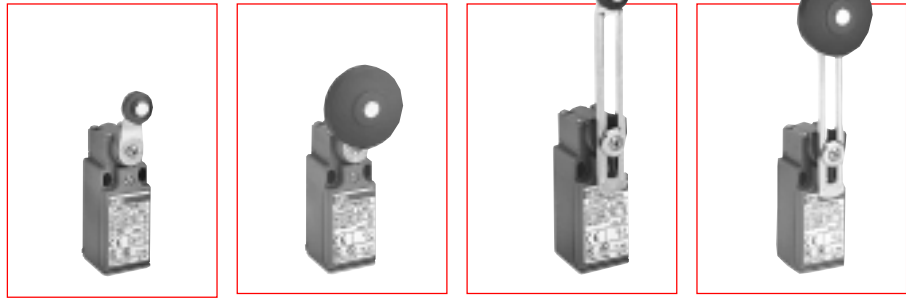

Operating head type

	Ø 18 Polyamide roller lever	Ø 45 Rubber roller lever	Adjustable Ø 18 polyamide roller lever	Adjustable Ø 45 rubber roller lever
Conformity / ⊕ (N.C. contact with positive opening operation)	EN 50 047			
Maximum actuation speed	m/s 1.5	1.5	1.5	1.5
Min. torque: - actuation	N.m 0.10	0.10	0.10	0.10
- positive opening operation	N.m 0.32	—	—	—

Additional technical data

Snap action contacts	Catalog number	LS35P41B11	LS35P42B11	LS35P51B11	LS35P52B11
	Operation diagram				
Non-overlapping slow action contacts	Catalog number	LS35P41D11	LS35P42D11	LS35P51D11	LS35P52D11
	Operation diagram				
Overlapping slow action contacts	Catalog number	LS35P41C11	LS35P42C11	LS35P51C11	LS35P52C11
	Operation diagram				
Slow action contacts	Catalog number	LS35P41L02	LS35P42L02	LS35P51L02	LS35P52L02
	Operation diagram				
Slow action contacts	Catalog number	LS35P41L20	LS35P42L20	LS35P51L20	LS35P52L20
	Operation diagram				
Snap action contacts	Catalog number	LS35P41B02	LS35P42B02	LS35P51B02	LS35P52B02
	Operation diagram				
Weight (packing per unit)	kg	0.090	0.120	0.100	0.130

Dimensions (mm)

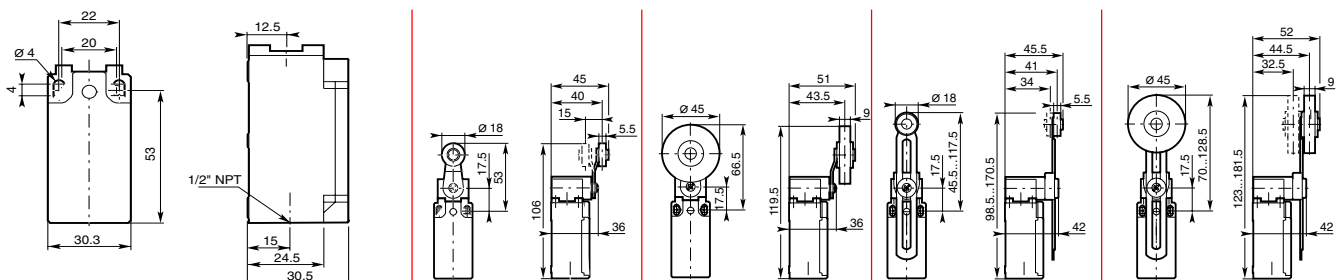

Technical data, 30mm

Double insulation, plastic casing, IP 65

1 Cable inlet for 1/2" NPT cable gland



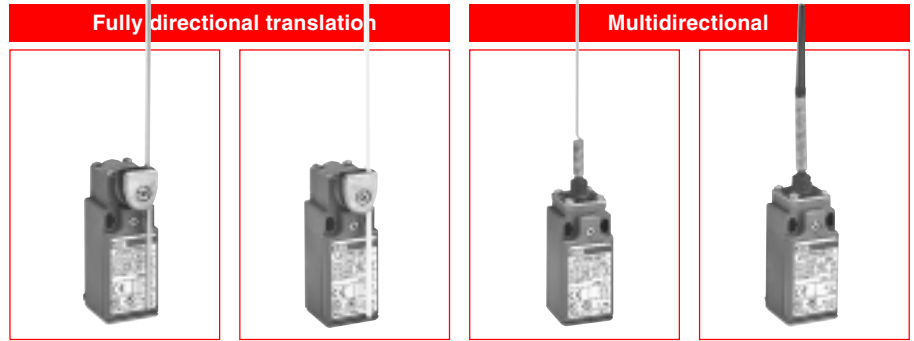



Movement to be detected

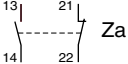
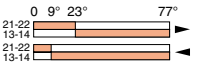
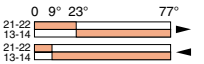
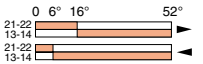
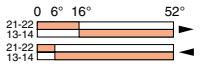
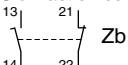
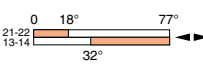
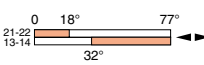
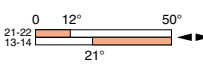
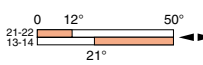
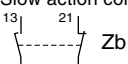
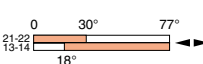
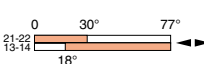
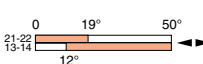
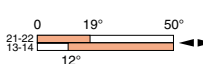
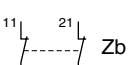
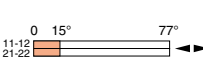
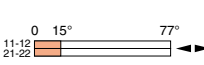

Operating head type

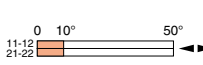
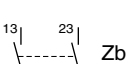
	Adjustable ø 3 stainless steel rod lever	Adjustable ø 3 fiber-glass rod lever	Spring rod	Flexible rod with insulated end
Conformity / \ominus (N.C. contact with positive opening operation)	■	■	■	■
Maximum actuation speed	1.5	1.5	1	1
Min. torque: - actuation	0.10	0.10	0.12	0.12
- positive opening operation	—	—	—	—

Additional technical data

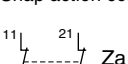
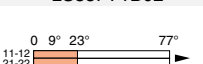
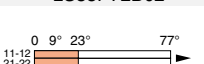
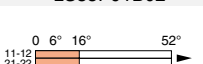
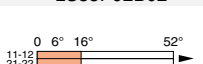
	Catalog number	LS35P71B11	LS35P72B11	LS35P91B11	LS35P92B11
Snap action contacts	Catalog number	LS35P71B11	LS35P72B11	LS35P91B11	LS35P92B11
	Operation diagram				
Non-overlapping Slow action contacts	Catalog number	LS35P71D11	LS35P72D11	LS35P91D11	LS35P92D11
	Operation diagram				
Overlapping Slow action contacts	Catalog number	LS35P71C11	LS35P72C11	LS35P91C11	LS35P92C11
	Operation diagram				
Slow action contacts	Catalog number	LS35P71L02	LS35P72L02	LS35P91L02	LS35P92L02
	Operation diagram				
Slow action contacts	Catalog number	LS35P71L20	LS35P72L20	LS35P91L20	LS35P92L20
	Operation diagram				
Snap action contacts	Catalog number	LS35P71B02	LS35P72B02	LS35P91B02	LS35P92B02
	Operation diagram				
Weight (packing per unit)	kg	0.100	0.100	0.080	0.080

Dimensions (mm)

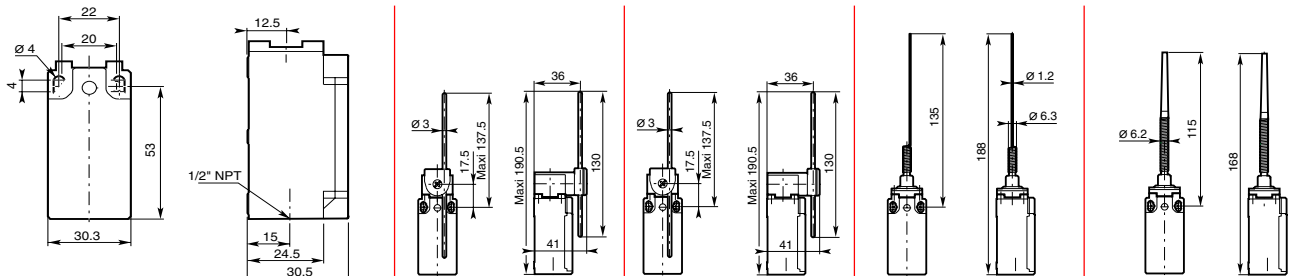

Technical data, 40mm

Double insulation, plastic casing, IP 65

1 Cable inlet for 1/2" NPT cable gland

Movement to be detected

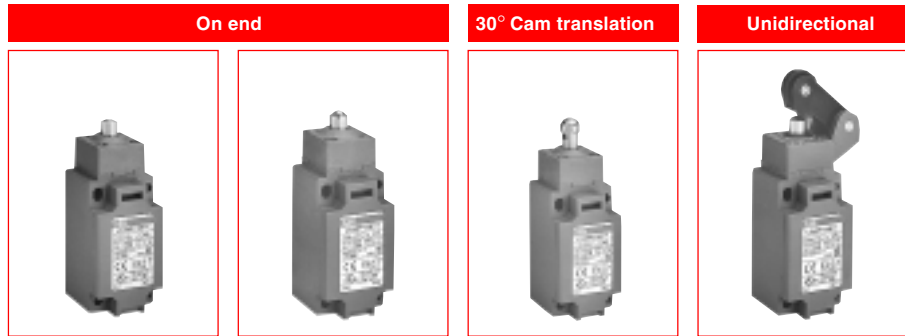

Operating head type

	Steel plain plunger	Steel ball plunger	Steel roller plunger	Polyamide roller lever
Conformity / \oplus (N.C. contact with positive opening operation)	EN 50 041 \oplus	EN 50 041 \oplus	EN 50 041 \oplus	\oplus
Maximum actuation speed m/s	0.5	0.5	0.5	1
Min. force/torque:				
- actuation	22 N	22 N	16 N	12 N
- positive opening operation	66 N	66 N	48 N	40 N

Additional technical data

Snap action contacts	Catalog number	LS45P11B11	LS45P12B11	LS45P13B11	LS45P31B11
	Operation diagram				
Non-overlapping Slow action contacts	Catalog number	LS45P11D11	LS45P12D11	LS45P13D11	LS45P31D11
	Operation diagram				
Overlapping Slow action contacts	Catalog number	LS45P11C11	LS45P12C11	LS45P13C11	LS45P31C11
	Operation diagram				
Slow action contacts	Catalog number	LS45P11L02	LS45P12L02	LS45P13L02	LS45P31L02
	Operation diagram				
Slow action contacts	Catalog number	LS45P11L20	LS45P12L20	LS45P13L20	LS45P31L20
	Operation diagram				
Snap action contacts	Catalog number	LS45P11B02	LS45P12B02	LS45P13B02	LS45P31B02
	Operation diagram				
Weight (packing per unit)	kg	0.140	0.140	0.145	0.175



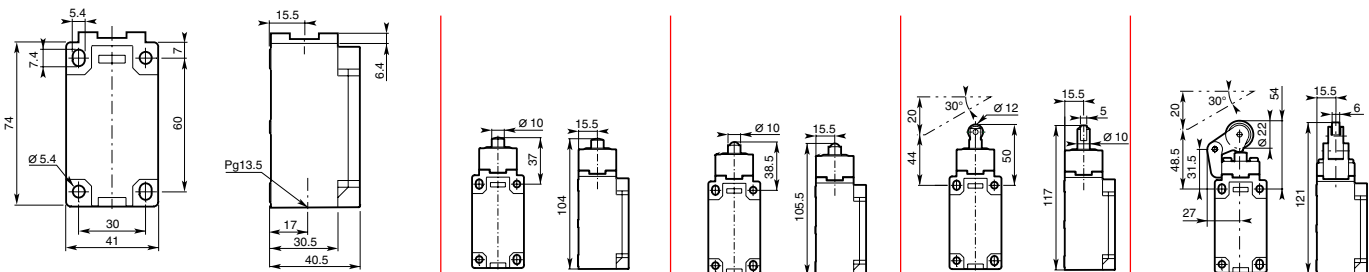









Dimensions (mm)



Technical data, 40mm

Double insulation, plastic casing, IP 65

1 Cable inlet for 1/2" NPT cable gland

30° Cam transl.		30° Cam translation movement			
					
Stainless steel roller lever	Ball-bearing roller lever	Ø 22 Polyamide roller lever	Ø 22 Stainless steel roller lever	Ø 22 Ball-bearing roller lever	Ø 45 Rubber roller lever
 1	 1	EN 50 041  1.5	EN 50 041  1.5	EN 50 041  1.5	 1.5
12 N 40 N	12 N 40 N	0.15 N.m 0.44 N.m	0.15 N.m 0.44 N.m	0.15 N.m 0.44 N.m	0.15 N.m -

Plastic limit switches

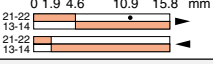
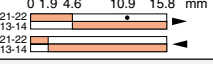
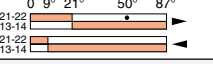
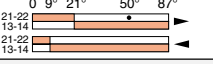
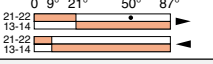
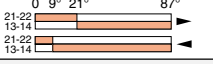
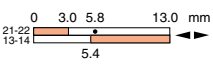
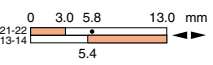
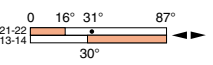
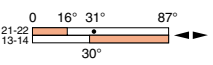
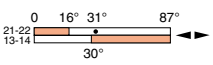
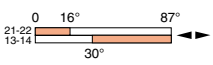
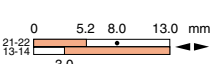
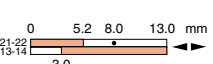
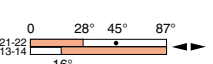
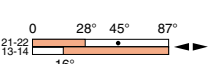
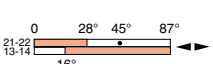
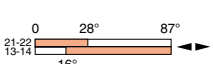
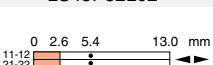
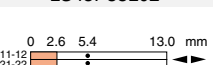
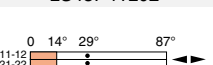
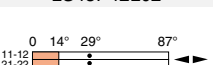
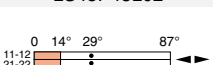
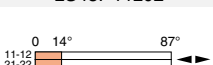
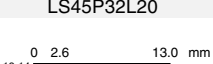
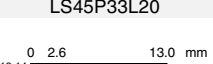
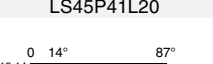
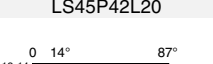
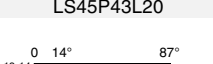
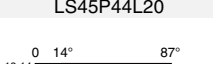
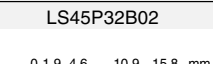
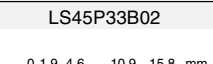
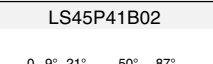
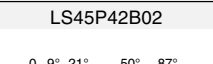
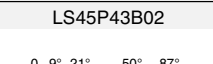
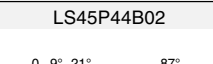
LS45P32B11 	LS45P33B11 	LS45P41B11 	LS45P42B11 	LS45P43B11 	LS45P44B11 
LS45P32D11 	LS45P33D11 	LS45P41D11 	LS45P42D11 	LS45P43D11 	LS45P44D11 
LS45P32C11 	LS45P33C11 	LS45P41C11 	LS45P42C11 	LS45P43C11 	LS45P44C11 
LS45P32L02 	LS45P33L02 	LS45P41L02 	LS45P42L02 	LS45P43L02 	LS45P44L02 
LS45P32L20 	LS45P33L20 	LS45P41L20 	LS45P42L20 	LS45P43L20 	LS45P44L20 
LS45P32B02 	LS45P33B02 	LS45P41B02 	LS45P42B02 	LS45P43B02 	LS45P44B02 
0.185	0.185	0.185	0.195	0.195	0.205

Dimensions (in mm)

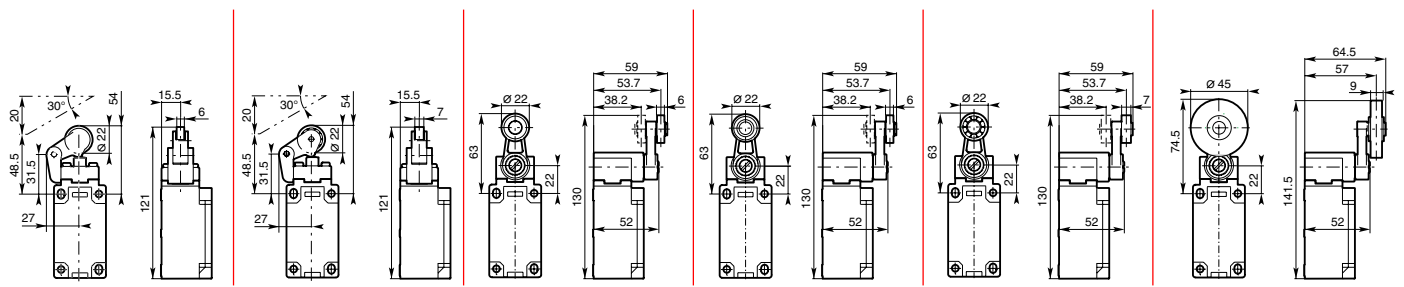

Technical data, 40mm

Double insulation, plastic casing, IP 65

1 Cable inlet for 1/2" NPT cable gland

Movement to be detected

30° Cam translation movement

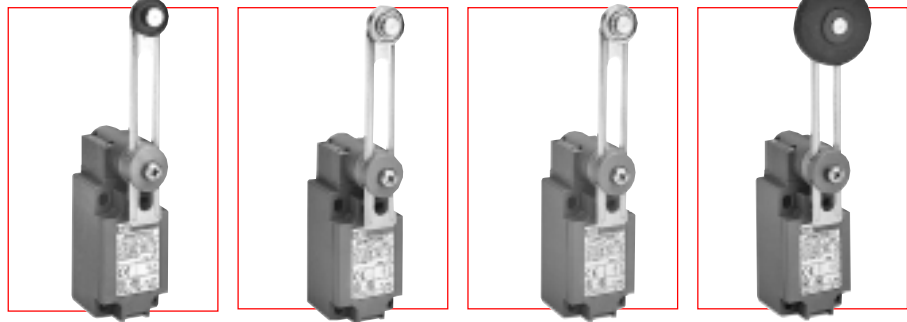

Operating head Catalog number

	Adjustable Ø 22 polyamide roller lever	Adjustable Ø 22 stainless steel roller lever	Adjustable Ø 22 stainless steel ball-bearing roller lever	Adjustable Ø 45 rubber roller lever
Conformity / \ominus (N.C. contact with positive opening operation)	<input type="checkbox"/>	<input type="checkbox"/>	<input type="checkbox"/>	<input type="checkbox"/>
Maximum actuation speed	1.5 m/s	1.5 m/s	1.5 m/s	1.5 m/s
Min. torque: - actuation	0.15 N.m	0.15 N.m	0.15 N.m	0.15 N.m
- positive opening operation	—	—	—	—

Additional technical data

Snap action contacts	Catalog number	LS45P51B11	LS45P52B11	LS45P53B11	LS45P54B11
	Operation diagram				
Non-overlapping Slow action contacts	Catalog number	LS45P51D11	LS45P52D11	LS45P53D11	LS45P54D11
	Operation diagram				
Overlapping Slow action contacts	Catalog number	LS45P51C11	LS45P52C11	LS45P53C11	LS45P54C11
	Operation diagram				
Slow action contacts	Catalog number	LS45P51L02	LS45P52L02	LS45P53L02	LS45P54L02
	Operation diagram				
Slow action contacts	Catalog number	LS45P51L20	LS45P52L20	LS45P53L20	LS45P54L20
	Operation diagram				
Snap action contacts	Catalog number	LS45P51B02	LS45P52B02	LS45P53B02	LS45P54B02
	Operation diagram				
Weight (packing per unit)	kg	0.190	0.200	0.200	0.200

Dimensions (in mm)

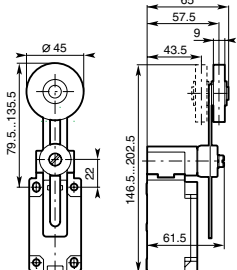
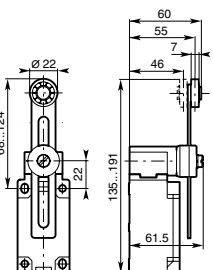
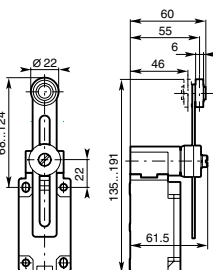
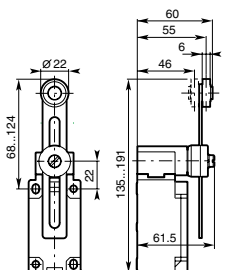
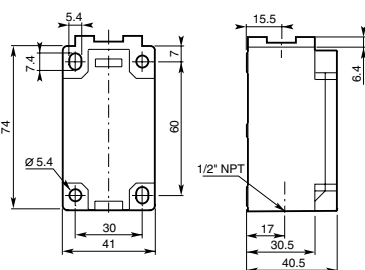

Technical data, 40mm

Double insulation, plastic casing, IP 65

1 Cable inlet for 1/2" NPT cable gland

Movement to be detected

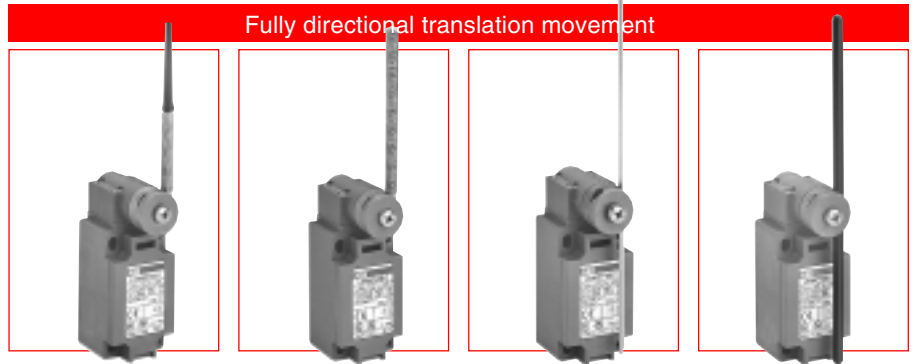

Operating head type

	Flexible lever with insulated end	Coil spring lever	Adjustable Ø 3 stainless steel rod lever	Adjustable ø 6 polyamide rod lever
Conformity / \oplus (N.C. contact with positive opening operation)			EN 50 041	EN 50 041
Maximum actuation speed	1.5 m/s	1.5 m/s	1.5 m/s	1.5 m/s
Min. torque: - actuation	0.15 N.m	0.15 N.m	0.15 N.m	0.15 N.m
- positive opening operation	- N.m	- N.m	- N.m	- N.m

Additional technical data

	Catalog number	LS45P61B11	LS45P62B11	LS45P71B11	LS45P72B11
Snap action contacts					
	Operation diagram				
Non-overlapping Slow action contacts					
	Operation diagram				
Overlapping Slow action contacts					
	Operation diagram				
Slow action contacts					
	Operation diagram				
Slow action contacts					
	Operation diagram				
Snap action contacts					
	Operation diagram				
Weight (packing per unit)	kg	0.190	0.190	0.185	0.185

Dimensions (in mm)

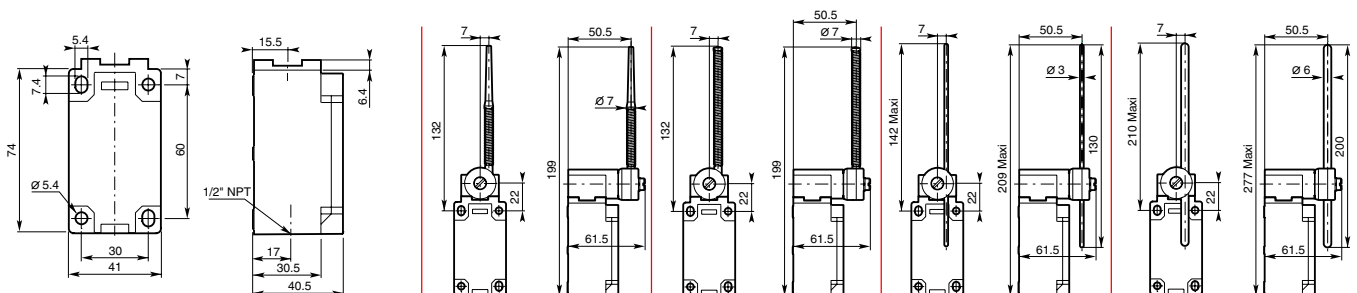

Technical data, 40mm

Double insulation, plastic casing, IP 65
1 Cable inlet for 1/2" NPT cable gland

Movement to be detected

Multidirectional

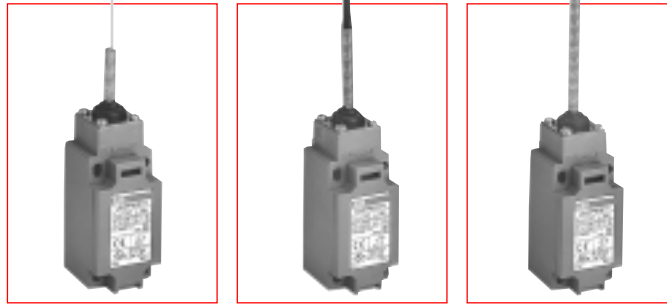

Operating head type

	Spring rod	Flexible rod with insulated end	Coil spring rod
Conformity / ⊕ (N.C. contact with positive opening operation)	■	■	■
Maximum actuation speed	1	1	1
Min. torque: - actuation	0.18	0.18	0.18
- positive opening operation	-	-	-

Additional technical data

Snap action contacts	Catalog number	LS45P91B11	LS45P92B11	LS45P93B11
	Operation diagram			
Non-overlapping Slow action contacts	Catalog number	LS45P91D11	LS45P92D11	LS45P93D11
	Operation diagram			
Overlapping Slow action contacts	Catalog number	LS45P91C11	LS45P92C11	LS45P93C11
	Operation diagram			
Slow action contacts	Catalog number	LS45P91L02	LS45P92L02	LS45P93L02
	Operation diagram			
Slow action contacts	Catalog number	LS45P91L20	LS45P92L20	LS45P93L20
	Operation diagram			
Snap action contacts	Catalog number	LS45P91B02	LS45P92B02	LS45P93B02
	Operation diagram			
Weight (packing per unit)	kg	0.135	0.140	0.145

Dimensions (in mm)

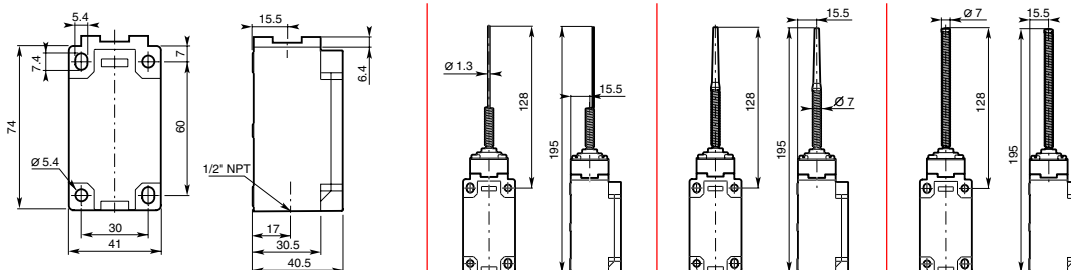



Limit Switches Metal casing, 40mm & 60mm



Description

Limit switches are made of aluminum alloy and have a degree of protection of IP 66.

The casings come in 2 dimensions:

- LS40M, 40mm width.
- LS45M, 40mm width.
- LS60M, 60mm width.
- LS60M, 60mm width.

UL Listed #E191693

Applications

Easy to use, electromechanical limit switches offer specific qualities:

- Visible operation.
- Able to switch strong currents (10 A conventional thermal current).
- Electrically separated contacts.
- Precise operating points (consistency).
- Immune to electromagnetic disturbances.

Limit switches used for these mechanical applications:

- Presence/absence.
- Positioning and travel limit.
- Objects passing/counting.

Selection guide

Metal casing, IP 66

40mm & 60mm

40mm width — LS40M, LS45M

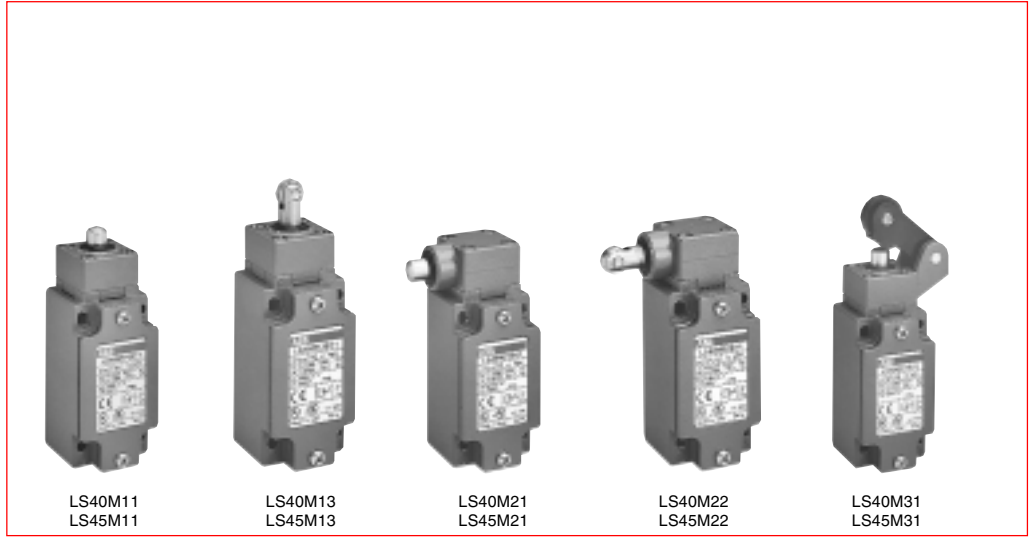

CENELEC conformity	EN 50 041	EN 50 041	EN 50 041	EN 50 041	—
Actuating device and actuation type	Plain plunger	Roller plunger	Plain plunger	Roller plunger	Roller lever
Positive contact opening					

Metal limit switches

60mm width — LS60M, LS65M

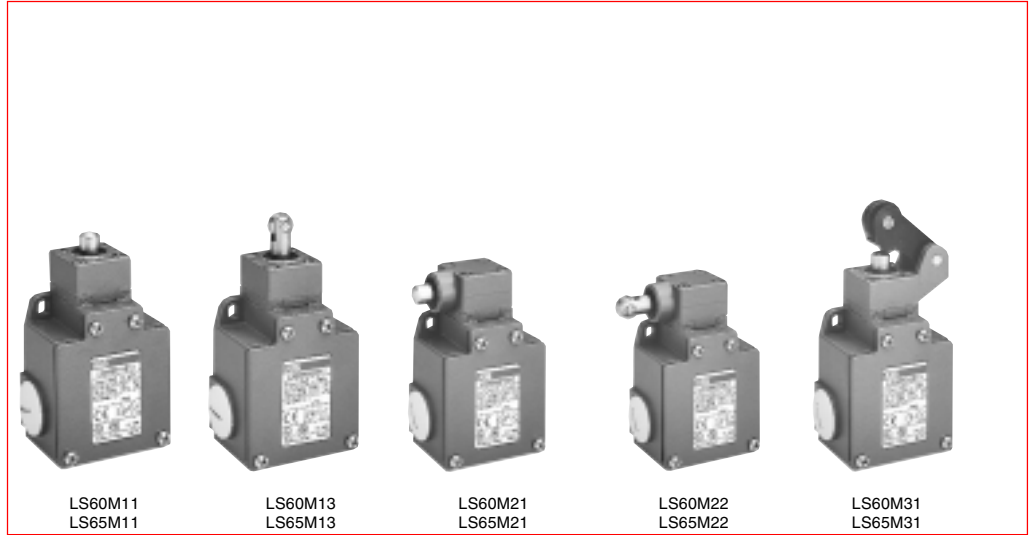

Actuating device and actuation type	Plain plunger	Roller plunger	Plain plunger	Roller plunger	Roller lever
Positive contact opening					

Selection guide
Metal casing, IP 66
40mm & 60mm



LS40M41
LS45M41

LS40M51
LS45M51

LS40M54
LS45M54

LS40M61
LS45M61

LS40M72
LS45M72

LS40M91
LS45M91

EN 50 041

EN 50 041

Roller lever

Adjustable roller levers

Adjustable flexible and rigid rod levers

Flexible rod

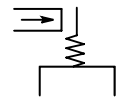
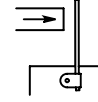
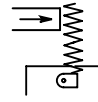
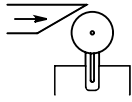
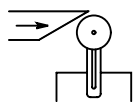
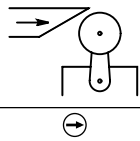

LS60M41
LS65M41

LS60M51
LS65M51

LS60M54
LS65M54

LS60M61
LS65M61

LS60M72
LS65M72

LS60M91
LS65M91

Roller lever

Adjustable roller levers

Adjustable flexible and rigid rod levers

Flexible rod

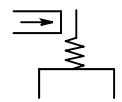
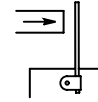
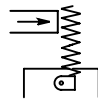
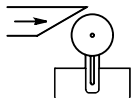
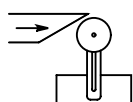
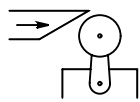

Metal limit switches

Description

LS40M, LS45M, LS60M and LS65M limit switches

Metal casing, IP66

Applications

Easy to use, electromechanical limit switches offer specific qualities:

- Visible operation.
- Able to switch strong currents (10 A conventional thermal current).
- Electrically separated contacts.
- Precise operating points (consistency).
- Immune to electromagnetic disturbances.

Limit switches used for these mechanical applications:

- Presence/absence.
- Positioning and travel limit.
- Objects passing/counting.

Description

Limit switches, which are made of aluminum alloy, have a degree of protection of IP 66.

The casings come in 2 dimensions:

- 40mm width
 - LS40M
 - LS45M
- 60mm width
 - LS60M
 - LS65M

Metal limit switches

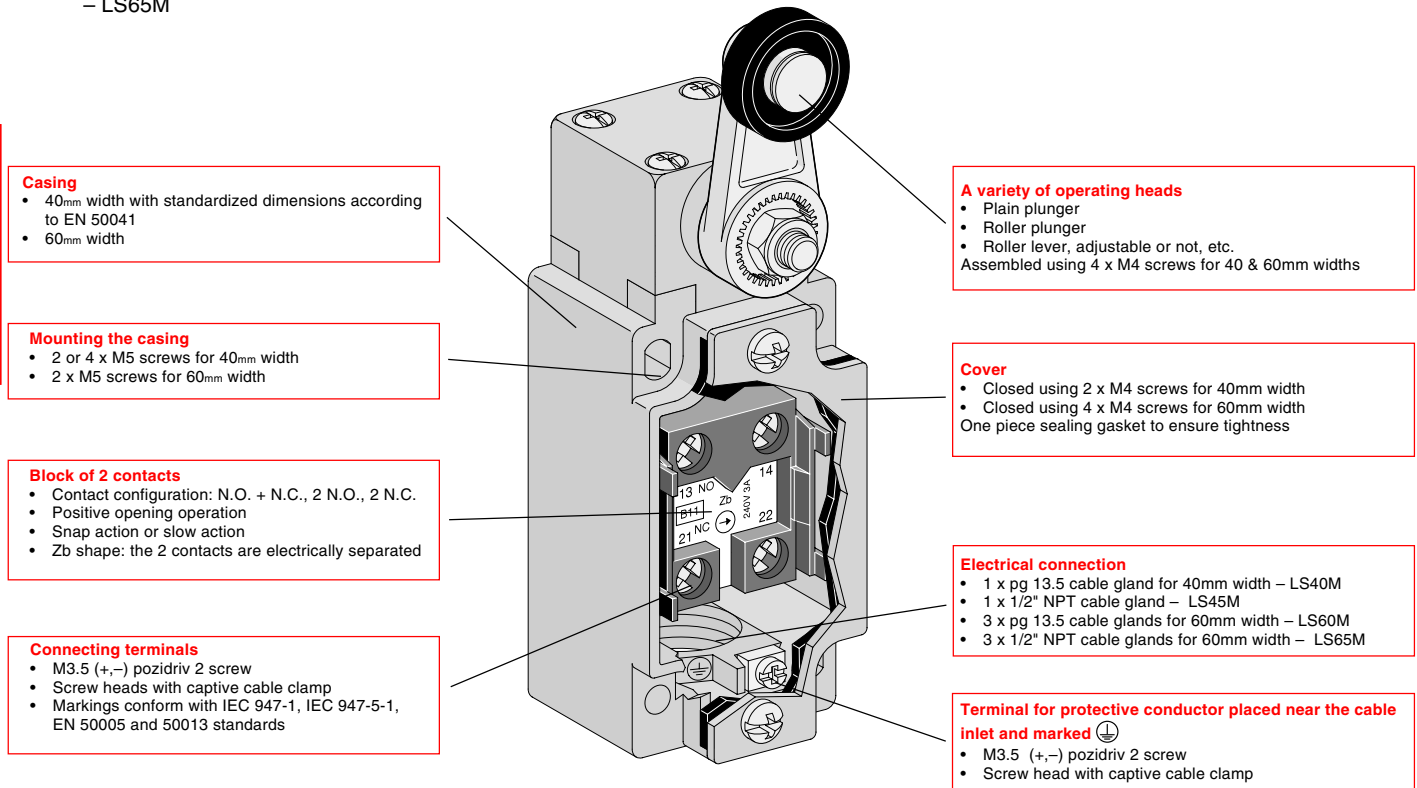

Catalog number explanation

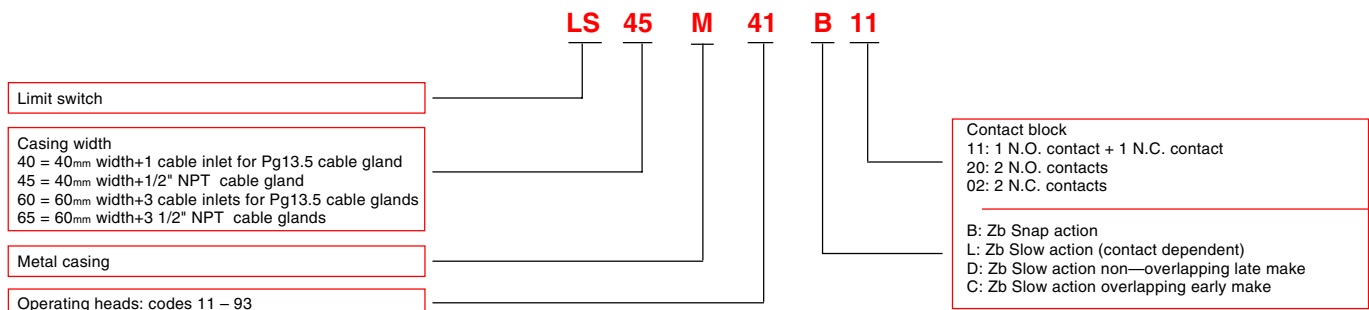

Implementation
LS40M, LS45M, LS60M and LS65M limit switches
Metal casing, IP66

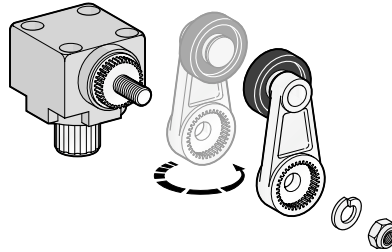

Lever round turning
 LS40M, LS45M, LS60M & LS65M

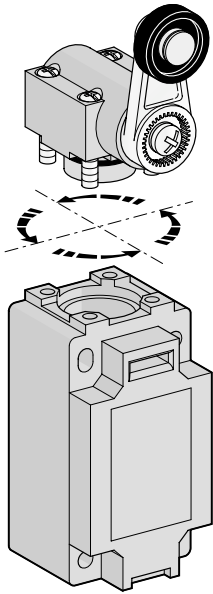

Head orientation

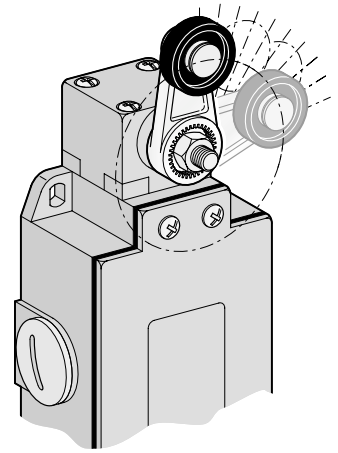

Free position adjustment 9 in 9° of lever



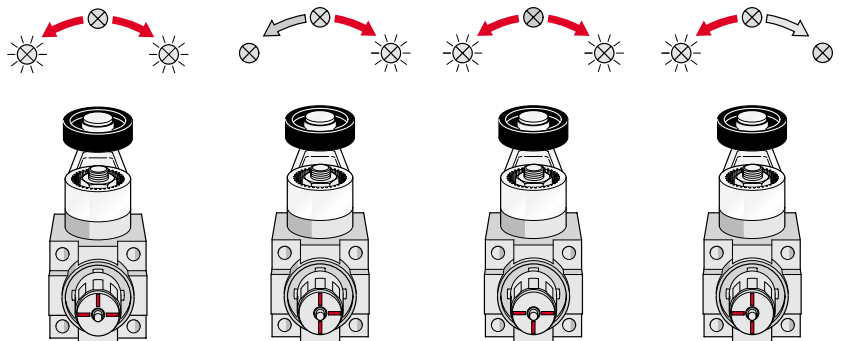
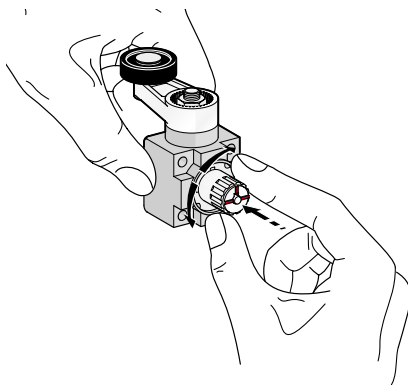



Metal limit switches



Operating mode selection

Metal casing, 40mm
IP 66
1 Cable inlet for 1/2" NPT cable gland

LS45M

Contact blocks						Unit weight in kg Packing 1 piece	Catalog number	List price
Snap action 	Non-overlapping slow action 	Overlapping slow action 	Slow action 	Slow action 	Snap action 			
Stainless steel plain plunger								
1	—	—	—	—	—	0.240	LS45M11B11	\$ 38
—	1	—	—	—	—	0.240	LS45M11D11	41
—	—	1	—	—	—	0.240	LS45M11C11	42
—	—	—	1	—	—	0.240	LS45M11L02	42
—	—	—	—	1	—	0.240	LS45M11L20	42
—	—	—	—	—	1	0.240	LS45M11B02	42
Stainless steel ball plunger								
1	—	—	—	—	—	0.240	LS45M12B11	41
—	1	—	—	—	—	0.240	LS45M12D11	44
—	—	1	—	—	—	0.240	LS45M12C11	45
—	—	—	1	—	—	0.240	LS45M12L02	45
—	—	—	—	1	—	0.240	LS45M12L20	45
—	—	—	—	—	1	0.240	LS45M12B02	45
Stainless steel lateral plain plunger								
1	—	—	—	—	—	0.260	LS45M21B11	41
—	1	—	—	—	—	0.260	LS45M21D11	44
—	—	1	—	—	—	0.260	LS45M21C11	45
—	—	—	1	—	—	0.260	LS45M21L02	45
—	—	—	—	1	—	0.260	LS45M21L20	45
—	—	—	—	—	1	0.260	LS45M21B02	45
Stainless steel roller plunger								
1	—	—	—	—	—	0.240	LS45M13B11	44
—	1	—	—	—	—	0.240	LS45M13D11	48
—	—	1	—	—	—	0.240	LS45M13C11	49
—	—	—	1	—	—	0.240	LS45M13L02	49
—	—	—	—	1	—	0.240	LS45M13L20	49
—	—	—	—	—	1	0.240	LS45M13B02	49
Lateral plunger with vertical roller								
1	—	—	—	—	—	0.265	LS45M22B11	45
—	1	—	—	—	—	0.265	LS45M22D11	48
—	—	1	—	—	—	0.265	LS45M22C11	50
—	—	—	1	—	—	0.265	LS45M22L02	50
—	—	—	—	1	—	0.265	LS45M22L20	50
—	—	—	—	—	1	0.265	LS45M22B02	50
Lateral plunger with horizontal roller								
1	—	—	—	—	—	0.265	LS45M23B11	45
—	1	—	—	—	—	0.265	LS45M23D11	48
—	—	1	—	—	—	0.265	LS45M23C11	50
—	—	—	1	—	—	0.265	LS45M23L02	50
—	—	—	—	1	—	0.265	LS45M23L20	50
—	—	—	—	—	1	0.265	LS45M23B02	50

Alternative threads

- For pg.13.5 cable gland, replace "45" with "40" in the catalog number.



LS45M11B11



LS45M12B11



LS45M13B11



LS45M21B11



LS45M23B11

Metal limit switches

Metal casing, 40mm
IP 66
1 Cable inlet for 1/2" NPT cable gland

LS45M



LS45M31B11



LS45M33B11



LS45M41B11



LS45M42B11



LS45M43B11

Contact blocks						Unit weight in kg Packing 1 piece	Catalog number	List price
Snap action Zb	Non-overlapping slow action Zb	Overlapping slow action Zb	Slow action Zb	Slow action Zb	Snap action Zb			
ø 22 polyamide roller lever								
1	—	—	—	—	—	0.275	LS45M31B11	\$ 43
—	1	—	—	—	—	0.275	LS45M31D11	46
—	—	1	—	—	—	0.275	LS45M31C11	47
—	—	—	1	—	—	0.275	LS45M31L02	47
—	—	—	—	1	—	0.275	LS45M31L20	47
—	—	—	—	—	1	0.275	LS45M31B02	47
ø 22 stainless steel roller lever								
1	—	—	—	—	—	0.280	LS45M32B11	50
—	1	—	—	—	—	0.280	LS45M32D11	53
—	—	1	—	—	—	0.280	LS45M32C11	55
—	—	—	1	—	—	0.280	LS45M32L02	55
—	—	—	—	1	—	0.280	LS45M32L20	55
—	—	—	—	—	1	0.280	LS45M32B02	55
ø 22 ball – bearing roller lever								
1	—	—	—	—	—	0.280	LS45M33B11	45
—	1	—	—	—	—	0.280	LS45M33D11	49
—	—	1	—	—	—	0.280	LS45M33C11	50
—	—	—	1	—	—	0.280	LS45M33L02	50
—	—	—	—	1	—	0.280	LS45M33L20	50
—	—	—	—	—	1	0.280	LS45M33B02	50
ø 22 polyamide roller lever								
1	—	—	—	—	—	0.280	LS45M41B11	50
—	1	—	—	—	—	0.280	LS45M41D11	53
—	—	1	—	—	—	0.280	LS45M41C11	55
—	—	—	1	—	—	0.280	LS45M41L02	55
—	—	—	—	1	—	0.280	LS45M41L20	55
—	—	—	—	—	1	0.280	LS45M41B02	55
ø 22 stainless steel roller lever								
1	—	—	—	—	—	0.280	LS45M42B11	57
—	1	—	—	—	—	0.280	LS45M42D11	61
—	—	1	—	—	—	0.280	LS45M42C11	63
—	—	—	1	—	—	0.280	LS45M42L02	63
—	—	—	—	1	—	0.280	LS45M42L20	63
—	—	—	—	—	1	0.280	LS45M42B02	63
ø 22 ball – bearing roller lever								
1	—	—	—	—	—	0.280	LS45M43B11	53
—	1	—	—	—	—	0.280	LS45M43D11	57
—	—	1	—	—	—	0.280	LS45M43C11	58
—	—	—	1	—	—	0.280	LS45M43L02	58
—	—	—	—	1	—	0.280	LS45M43L20	58
—	—	—	—	—	1	0.280	LS45M43B02	58







Alternative threads

- For pg.13.5 cable gland, replace "45" with "40" in the catalog number.

Metal limit switches

Metal casing, 40mm
IP 66
1 Cable inlet for 1/2" NPT cable gland

LS45M

Contact blocks						Unit weight in kg Packing 1 piece	Catalog number	List price
Snap action 	Non-overlapping slow action 	Overlapping slow action 	Slow action 	Slow action 	Snap action 			
ø 45 rubber roller lever								
1	—	—	—	—	—	0.310	LS45M44B11	\$ 51
—	1	—	—	—	—	0.310	LS45M44D11	55
—	—	1	—	—	—	0.310	LS45M44C11	57
—	—	—	1	—	—	0.310	LS45M44L02	57
—	—	—	—	1	—	0.310	LS45M44L20	57
—	—	—	—	—	1	0.310	LS45M44B02	57
Adjustable ø 22 polyamide roller lever								
1	—	—	—	—	—	0.290	LS45M51B11	51
—	1	—	—	—	—	0.290	LS45M51D11	55
—	—	1	—	—	—	0.290	LS45M51C11	57
—	—	—	1	—	—	0.290	LS45M51L02	57
—	—	—	—	1	—	0.290	LS45M51L20	57
—	—	—	—	—	1	0.290	LS45M51B02	57
Adjustable ø 22 stainless steel roller lever								
1	—	—	—	—	—	0.300	LS45M52B11	59
—	1	—	—	—	—	0.300	LS45M52D11	63
—	—	1	—	—	—	0.300	LS45M52C11	65
—	—	—	1	—	—	0.300	LS45M52L02	65
—	—	—	—	1	—	0.300	LS45M52L20	65
—	—	—	—	—	1	0.300	LS45M52B02	65
Adjustable ø 22 ball-bearing roller lever								
1	—	—	—	—	—	0.300	LS45M53B11	55
—	1	—	—	—	—	0.300	LS45M53D11	59
—	—	1	—	—	—	0.300	LS45M53C11	61
—	—	—	1	—	—	0.300	LS45M53L02	61
—	—	—	—	1	—	0.300	LS45M53L20	61
—	—	—	—	—	1	0.300	LS45M53B02	61
Adjustable ø 45 rubber roller lever								
1	—	—	—	—	—	0.315	LS45M54B11	53
—	1	—	—	—	—	0.315	LS45M54D11	57
—	—	1	—	—	—	0.315	LS45M54C11	58
—	—	—	1	—	—	0.315	LS45M54L02	58
—	—	—	—	1	—	0.315	LS45M54L20	58
—	—	—	—	—	1	0.315	LS45M54B02	58
Flexible lever with insulated end								
1	—	—	—	—	—	0.290	LS45M61B11	50
—	1	—	—	—	—	0.290	LS45M61D11	53
—	—	1	—	—	—	0.290	LS45M61C11	55
—	—	—	1	—	—	0.290	LS45M61L02	55
—	—	—	—	1	—	0.290	LS45M61L20	55
—	—	—	—	—	1	0.290	LS45M61B02	55

Alternative threads

- For pg.13.5 cable gland, replace "45" with "40" in the catalog number.



LS45M44B11



LS45M51B11



LS45M53B11



LS45M54B11



LS45M61B11

Metal casing, 40mm
IP 66
1 Cable inlet for 1/2" NPT cable gland

LS45M

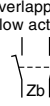
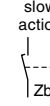
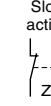
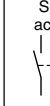
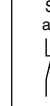
Contact blocks						Unit weight in kg Packing 1 piece	Catalog number	List price
Snap action  Zb	Non-overlapping slow action  Zb	Overlapping slow action  Zb	Slow action  Zb	Slow action  Zb	Snap action  Zb			
Coil spring lever								
1	—	—	—	—	—	0.295	LS45M62B11	\$ 50
—	1	—	—	—	—	0.295	LS45M62D11	53
—	—	1	—	—	—	0.295	LS45M62C11	55
—	—	—	1	—	—	0.295	LS45M62L02	55
—	—	—	—	1	—	0.295	LS45M62L20	55
—	—	—	—	—	1	0.295	LS45M62B02	55
Adjustable ø 3 mm stainless steel rod lever								
1	—	—	—	—	—	0.285	LS45M71B11	47
—	1	—	—	—	—	0.285	LS45M71D11	51
—	—	1	—	—	—	0.285	LS45M71C11	53
—	—	—	1	—	—	0.285	LS45M71L02	53
—	—	—	—	1	—	0.285	LS45M71L20	53
—	—	—	—	—	1	0.285	LS45M71B02	53
Adjustable ø 6 mm polyamide rod lever								
1	—	—	—	—	—	0.285	LS45M72B11	47
—	1	—	—	—	—	0.285	LS45M72D11	50
—	—	1	—	—	—	0.285	LS45M72C11	52
—	—	—	1	—	—	0.285	LS45M72L02	52
—	—	—	—	1	—	0.285	LS45M72L20	52
—	—	—	—	—	1	0.285	LS45M72B02	52
Spring rod								
1	—	—	—	—	—	0.235	LS45M91B11	41
—	1	—	—	—	—	0.235	LS45M91D11	43
—	—	1	—	—	—	0.235	LS45M91C11	45
—	—	—	1	—	—	0.235	LS45M91L02	45
—	—	—	—	1	—	0.235	LS45M91L20	45
—	—	—	—	—	1	0.235	LS45M91B02	45
Flexible rod with insulated end								
1	—	—	—	—	—	0.235	LS45M92B11	43
—	1	—	—	—	—	0.235	LS45M92D11	46
—	—	1	—	—	—	0.235	LS45M92C11	47
—	—	—	1	—	—	0.235	LS45M92L02	47
—	—	—	—	1	—	0.235	LS45M92L20	47
—	—	—	—	—	1	0.235	LS45M92B02	47
Coil spring rod								
1	—	—	—	—	—	0.235	LS45M93B11	42
—	1	—	—	—	—	0.235	LS45M93D11	45
—	—	1	—	—	—	0.235	LS45M93C11	47
—	—	—	1	—	—	0.235	LS45M93L02	47
—	—	—	—	1	—	0.235	LS45M93L20	47
—	—	—	—	—	1	0.235	LS45M93B02	47

Alternative threads

- For pg.13.5 cable gland, replace "45" with "40" in the catalog number.

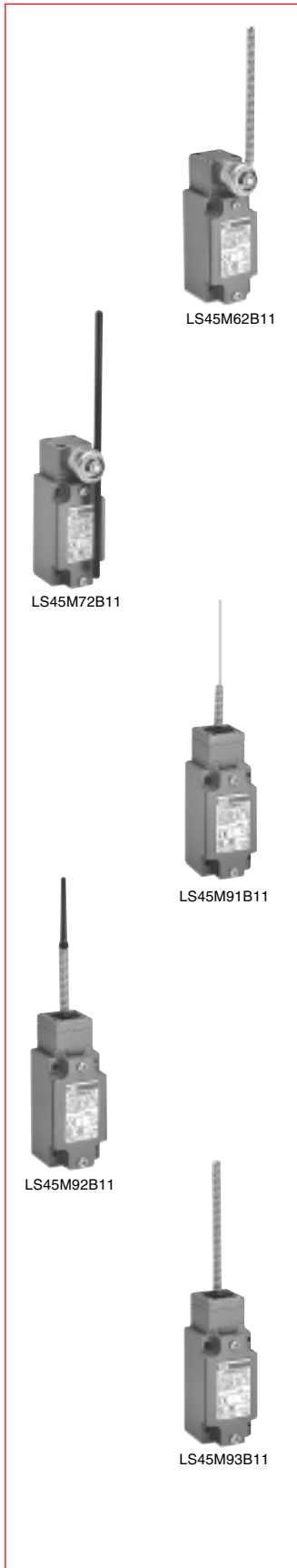

Metal limit switches

Metal casing, 60mm
IP 66
3 Cable inlets for 1/2" NPT cable gland



LS65M11B11



LS65M12B11



LS65M21B11









LS65M22B11



LS65M23B11

Metal limit switches

LS65M

Contact blocks						Unit weight in kg Packing 1 piece	Catalog number	List price
Snap action 	Non-overlapping slow action 	Overlapping slow action 	Slow action 	Slow action 	Snap action 			
Stainless steel plain plunger								
1	—	—	—	—	—	0.265	LS65M11B11	\$ 40
—	1	—	—	—	—	0.265	LS65M11D11	43
—	—	1	—	—	—	0.265	LS65M11C11	44
—	—	—	1	—	—	0.265	LS65M11L02	44
—	—	—	—	1	—	0.265	LS65M11L20	44
—	—	—	—	—	1	0.265	LS65M11B02	44
Stainless steel ball plunger								
1	—	—	—	—	—	0.265	LS65M12B11	42
—	1	—	—	—	—	0.265	LS65M12D11	45
—	—	1	—	—	—	0.265	LS65M12C11	47
—	—	—	1	—	—	0.265	LS65M12L02	47
—	—	—	—	1	—	0.265	LS65M12L20	47
—	—	—	—	—	1	0.265	LS65M12B02	47
Stainless steel lateral plain plunger								
1	—	—	—	—	—	0.280	LS65M21B11	42
—	1	—	—	—	—	0.280	LS65M21D11	45
—	—	1	—	—	—	0.280	LS65M21C11	47
—	—	—	1	—	—	0.280	LS65M21L02	47
—	—	—	—	1	—	0.280	LS65M21L20	47
—	—	—	—	—	1	0.280	LS65M21B02	47
Stainless steel roller plunger								
1	—	—	—	—	—	0.270	LS65M13B11	46
—	1	—	—	—	—	0.270	LS65M13D11	49
—	—	1	—	—	—	0.270	LS65M13C11	51
—	—	—	1	—	—	0.270	LS65M13L02	51
—	—	—	—	1	—	0.270	LS65M13L20	51
—	—	—	—	—	1	0.270	LS65M13B02	51
Lateral plunger with vertical roller								
1	—	—	—	—	—	0.280	LS65M22B11	47
—	1	—	—	—	—	0.280	LS65M22D11	50
—	—	1	—	—	—	0.280	LS65M22C11	52
—	—	—	1	—	—	0.280	LS65M22L02	52
—	—	—	—	1	—	0.280	LS65M22L20	52
—	—	—	—	—	1	0.280	LS65M22B02	52
Lateral plunger with horizontal roller								
1	—	—	—	—	—	0.280	LS65M23B11	47
—	1	—	—	—	—	0.280	LS65M23D11	50
—	—	1	—	—	—	0.280	LS65M23C11	52
—	—	—	1	—	—	0.280	LS65M23L02	52
—	—	—	—	1	—	0.280	LS65M23L20	52
—	—	—	—	—	1	0.280	LS65M23B02	52

Alternative threads

- For pg.13.5 cable gland, replace "65" with "60" in the catalog number.

Metal casing, 60mm
IP 66
3 Cable inlets for 1/2" NPT cable gland

LS65M

Contact blocks						Unit weight in kg Packing 1 piece	Catalog number	List price
Snap action Zb	Non-overlapping slow action Zb	Overlapping slow action Zb	Slow action Zb	Slow action Zb	Snap action Zb			
ø 22 polyamide roller lever								
1	—	—	—	—	—	0.290	LS65M31B11	\$ 44
—	1	—	—	—	—	0.290	LS65M31D11	47
—	—	1	—	—	—	0.290	LS65M31C11	49
—	—	—	1	—	—	0.290	LS65M31L02	49
—	—	—	—	1	—	0.290	LS65M31L20	49
—	—	—	—	—	1	0.290	LS65M31B02	49
ø 22 stainless steel roller lever								
1	—	—	—	—	—	0.300	LS65M32B11	51
—	1	—	—	—	—	0.300	LS65M32D11	55
—	—	1	—	—	—	0.300	LS65M32C11	57
—	—	—	1	—	—	0.300	LS65M32L02	57
—	—	—	—	1	—	0.300	LS65M32L20	57
—	—	—	—	—	1	0.300	LS65M32B02	57
Ball—bearing roller lever								
1	—	—	—	—	—	0.300	LS65M33B11	47
—	1	—	—	—	—	0.300	LS65M33D11	51
—	—	1	—	—	—	0.300	LS65M33C11	52
—	—	—	1	—	—	0.300	LS65M33L02	52
—	—	—	—	1	—	0.300	LS65M33L20	52
—	—	—	—	—	1	0.300	LS65M33B02	52
ø 22 polyamide roller lever								
1	—	—	—	—	—	0.300	LS65M41B11	51
—	1	—	—	—	—	0.300	LS65M41D11	55
—	—	1	—	—	—	0.300	LS65M41C11	57
—	—	—	1	—	—	0.300	LS65M41L02	57
—	—	—	—	1	—	0.300	LS65M41L20	57
—	—	—	—	—	1	0.300	LS65M41B02	57
ø 22 stainless steel roller lever								
1	—	—	—	—	—	0.305	LS65M42B11	58
—	1	—	—	—	—	0.305	LS65M42D11	63
—	—	1	—	—	—	0.305	LS65M42C11	65
—	—	—	1	—	—	0.305	LS65M42L02	65
—	—	—	—	1	—	0.305	LS65M42L20	65
—	—	—	—	—	1	0.305	LS65M42B02	65
ø 22 ball-bearing roller lever								
1	—	—	—	—	—	0.305	LS65M43B11	54
—	1	—	—	—	—	0.305	LS65M43D11	58
—	—	1	—	—	—	0.305	LS65M43C11	60
—	—	—	1	—	—	0.305	LS65M43L02	60
—	—	—	—	1	—	0.305	LS65M43L20	60
—	—	—	—	—	1	0.305	LS65M43B02	60

Alternative threads

- For pg.13.5 cable gland, replace "65" with "60" in the catalog number.



LS65M31B11



LS65M33B11



LS65M41B11



LS65M42B11



LS65M43B11

Metal limit switches

Metal casing, 60mm
IP 66
3 Cable inlets for 1/2" NPT cable gland



LS65M44B11



LS65M51B11



LS65M53B11



LS65M54B11



LS65M61B11

LS65M

Contact blocks						Unit weight in kg Packing 1 piece	Catalog number	List price
Snap action Zb	Non-overlapping slow action Zb	Overlapping slow action Zb	Slow action Zb	Slow action Zb	Snap action Zb			
ø 45 rubber roller lever								
1	—	—	—	—	—	0.330	LS65M44B11	\$ 53
—	1	—	—	—	—	0.330	LS65M44D11	56
—	—	1	—	—	—	0.330	LS65M44C11	58
—	—	—	1	—	—	0.330	LS65M44L02	58
—	—	—	—	1	—	0.330	LS65M44L20	58
—	—	—	—	—	1	0.330	LS65M44B02	58
Adjustable ø 22 polyamide roller lever								
1	—	—	—	—	—	0.315	LS65M51B11	53
—	1	—	—	—	—	0.315	LS65M51D11	57
—	—	1	—	—	—	0.315	LS65M51C11	59
—	—	—	1	—	—	0.315	LS65M51L02	59
—	—	—	—	1	—	0.315	LS65M51L20	59
—	—	—	—	—	1	0.315	LS65M51B02	59
Adjustable ø 22 stainless steel roller lever								
1	—	—	—	—	—	0.325	LS65M52B11	60
—	1	—	—	—	—	0.325	LS65M52D11	65
—	—	1	—	—	—	0.325	LS65M52C11	67
—	—	—	1	—	—	0.325	LS65M52L02	67
—	—	—	—	1	—	0.325	LS65M52L20	67
—	—	—	—	—	1	0.325	LS65M52B02	67
Adjustable ø 22 stainless steel ball-bearing roller lever								
1	—	—	—	—	—	0.325	LS65M53B11	56
—	1	—	—	—	—	0.325	LS65M53D11	60
—	—	1	—	—	—	0.325	LS65M53C11	62
—	—	—	1	—	—	0.325	LS65M53L02	62
—	—	—	—	1	—	0.325	LS65M53L20	62
—	—	—	—	—	1	0.325	LS65M53B02	62
Adjustable ø 45 rubber roller lever								
1	—	—	—	—	—	0.335	LS65M54B11	54
—	1	—	—	—	—	0.335	LS65M54D11	58
—	—	1	—	—	—	0.335	LS65M54C11	60
—	—	—	1	—	—	0.335	LS65M54L02	60
—	—	—	—	1	—	0.335	LS65M54L20	60
—	—	—	—	—	1	0.335	LS65M54B02	60
Flexible lever with insulated end								
1	—	—	—	—	—	0.320	LS65M61B11	52
—	1	—	—	—	—	0.320	LS65M61D11	55
—	—	1	—	—	—	0.320	LS65M61C11	57
—	—	—	1	—	—	0.320	LS65M61L02	57
—	—	—	—	1	—	0.320	LS65M61L20	57
—	—	—	—	—	1	0.320	LS65M61B02	57

Alternative threads

- For pg.13.5 cable gland, replace "65" with "60" in the catalog number.

Metal casing, 60mm
IP 66
3 Cable inlets for 1/2" NPT cable gland



LS65M

Contact blocks						Unit weight in kg Packing 1 piece	Catalog number	List price
Snap action Zb	Non-overlapping slow action Zb	Overlapping slow action Zb	Slow action Zb	Slow action Zb	Snap action Zb			
Coil spring lever								
1	—	—	—	—	—	0.325	LS65M62B11	\$ 51
—	1	—	—	—	—	0.325	LS65M62D11	55
—	—	1	—	—	—	0.325	LS65M62C11	57
—	—	—	1	—	—	0.325	LS65M62L02	57
—	—	—	—	1	—	0.325	LS65M62L20	57
—	—	—	—	—	1	0.325	LS65M62B02	57
Adjustable ø 3 mm stainless steel rod lever								
1	—	—	—	—	—	0.315	LS65M71B11	49
—	1	—	—	—	—	0.315	LS65M71D11	53
—	—	1	—	—	—	0.315	LS65M71C11	54
—	—	—	1	—	—	0.315	LS65M71L02	54
—	—	—	—	1	—	0.315	LS65M71L20	54
—	—	—	—	—	1	0.315	LS65M71B02	54
Adjustable ø 6 mm polyamide rod lever								
1	—	—	—	—	—	0.315	LS65M72B11	49
—	1	—	—	—	—	0.315	LS65M72D11	52
—	—	1	—	—	—	0.315	LS65M72C11	54
—	—	—	1	—	—	0.315	LS65M72L02	54
—	—	—	—	1	—	0.315	LS65M72L20	54
—	—	—	—	—	1	0.315	LS65M72B02	54
Spring rod								
1	—	—	—	—	—	0.255	LS65M91B11	42
—	1	—	—	—	—	0.255	LS65M91D11	45
—	—	1	—	—	—	0.255	LS65M91C11	47
—	—	—	1	—	—	0.255	LS65M91L02	47
—	—	—	—	1	—	0.255	LS65M91L20	47
—	—	—	—	—	1	0.255	LS65M91B02	47
Flexible rod with insulated end								
1	—	—	—	—	—	0.260	LS65M92B11	44
—	1	—	—	—	—	0.260	LS65M92D11	47
—	—	1	—	—	—	0.260	LS65M92C11	49
—	—	—	1	—	—	0.260	LS65M92L02	49
—	—	—	—	1	—	0.260	LS65M92L20	49
—	—	—	—	—	1	0.260	LS65M92B02	49
Coil spring rod								
1	—	—	—	—	—	0.255	LS65M93B11	44
—	1	—	—	—	—	0.255	LS65M93D11	47
—	—	1	—	—	—	0.255	LS65M93C11	48
—	—	—	1	—	—	0.255	LS65M93L02	48
—	—	—	—	1	—	0.255	LS65M93L20	48
—	—	—	—	—	1	0.255	LS65M93B02	48

Alternative threads

- For pg.13.5 cable gland, replace "65" with "60" in the catalog number.

Metal limit switches

Technical data

Metal casing, IP 66

General technical data

		Plastic casing	Metal casing
Standards		Devices conform with international IEC 947-5-1 and European EN 60 947-5-1 standards	
Certifications - Approvals		UL & CSA	
Air temperature near the device (IEC)			
- during operation	°C	- 25 ... + 70	- 25 ... + 70
- for storage	°C	- 30 ... + 80	- 30 ... + 80
Climatic withstand		According to IEC 68-2-3 and salty mist according to IEC 68-2-11	
Mounting positions		All positions are authorized	
Shock withstand (according to IEC 68-2-27 and EN 60 068-2-27)		50g ^① (1/2 sinusoidal shock for 11 ms) no change in contact position	
Resistance to vibrations (acc. to IEC 68-2-6 and EN 60 068-2-6)		25g (10 – 500 Hz) no change in position of contacts greater than 100μs	
Protection against electrical shocks (acc. to IEC 536)		Class II	Class I
Degree of protection (according to IEC 529 and EN 60 529)		IP 65	IP 66
Consistency (measured over 1 million operations)		0.1 mm (upon closing point)	0.05 mm (upon closing point)
Minimum actuation speed		m/s Slow action contacts 0.060 / Snap action contacts 0.001	

Electrical Data

Rated insulation voltage U_i		500 V (degree of pollution 3)			
- according to IEC 947-1 and EN 60-947-1		A 600, Q 600			
- according to UL 508 and CSA C22-2 n° 14					
Rated impulse withstand voltage U _{imp} (according to IEC 947-1 and EN 60 947-1)	kV	6			
Conventional free air thermal current I _{th} (according to IEC 947-5-1) q ≤ 40 °C	A	10			
Short-circuit protection U _o ≤ 500 V a.c. - gG (gl) type fuses	A	10			
Rated operational current I _e / AC-15 (according to IEC 947-5-1)	24 V - 50/60 Hz	A	10		
	130 V - 50/60 Hz	A	5.5		
	230 V - 50/60 Hz	A	3.1		
	240 V - 50/60 Hz	A	3		
	400 V - 50/60 Hz	A	1.8		
I _e / DC-13 (according to IEC 947-5-1)	24 V - d.c.	A	2.8		
	110 V - d.c.	A	0.6		
	250 V - d.c.	A	0.27		
Switching frequency	Cycles/h	3600			
Load factor		0.5			
Resistance between contacts	mW	25			
Connecting terminals		M3.5 (+, -) pozidriv 2 screw with cable clamp			
Terminal for protective conductor		-	M3.5 (+, -) pozidriv 2 screw with cable clamp		
Connecting capacity	1 or 2 x mm ²	0.5 ... 2.5			
Terminal marking		According to EN 50 013			
Mechanical durability	Millions of operations	15 } 10 } 5 } > 1 }	30 } 25 } 10 }	LS 30 P { 10 - 12; 30 - 34 31 { 13; 41 - 44; 51 - 54; 61 - 72 40 { 91 - 93 40 { 15; 16	M { 11 - 13; 21 - 23; 31 - 33 40 { 41 - 44; 51 - 54; 61 - 72 60 { 91 - 93
Electrical durability (according to IEC 947-5-1)		Utilization categories AC-15 and DC-13 (Load factor of 0.5 according to curves below)			

Metal limit switches

AC-15 — Snap action

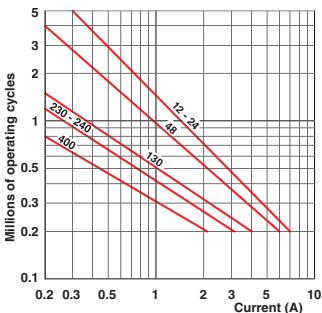

AC-15 — Slow action

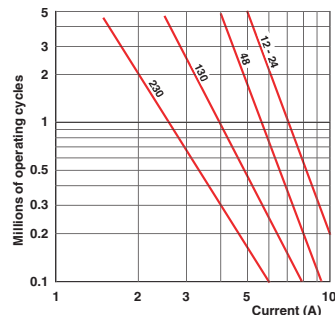

DC-13	Snap action	Slow action
	Power breaking for a durability of 5 million operating cycles	
Voltage	24 V	12 W
Voltage	48 V	9 W
Voltage	110 V	6 W

^① except for LS30/31/35 (P42): 25g

Technical data, 40mm

Metal casing, IP 66

1 Cable inlet for 1/2" NPT cable gland

Movement to be detected

On end

30° Cam

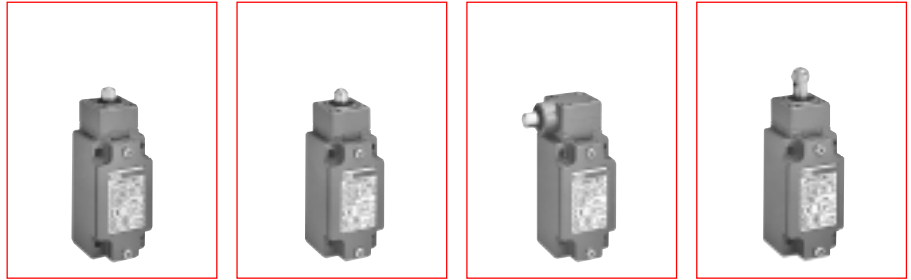

Operating head type

	Stainless steel plain plunger	Stainless steel ball plunger	Stainless steel lateral plain plunger	Stainless steel roller plunger
Conformity / \ominus (N.C. contact with positive opening operation)	EN 50 041 \ominus	EN 50 041 \ominus	EN 50 041 \ominus	EN 50 041 \ominus
Maximum actuation speed m/s	0.5	0.5	0.5	0.5
Min. force: - actuation	N 22	N 22	N 30	N 16
- positive opening operation	N 66	N 66	N 70	N 48

Additional technical data

Snap action contacts	Catalog number	LS45M11B11	LS45M12B11	LS45M21B11	LS45M13B11
Za	Operation diagram				
Non-overlapping Slow action contacts	Catalog number	LS45M11D11	LS45M12D11	LS45M21D11	LS45M13D11
Zb	Operation diagram				
Overlapping Slow action contacts	Catalog number	LS45M11C11	LS45M12C11	LS45M21C11	LS45M13C11
Zb	Operation diagram				
Slow action contacts	Catalog number	LS45M11L02	LS45M12L02	LS45M21L02	LS45M13L02
Zb	Operation diagram				
Slow action contacts	Catalog number	LS45M11L20	LS45M12L20	LS45M21L20	LS45M13L20
Zb	Operation diagram				
Snap action contacts	Catalog number	LS45M11B02	LS45M12B02	LS45M21B02	LS45M13B02
Za	Operation diagram				
Weight (packing per unit)	kg	0.240	0.240	0.260	0.240

Metal limit switches

Dimensions (mm)

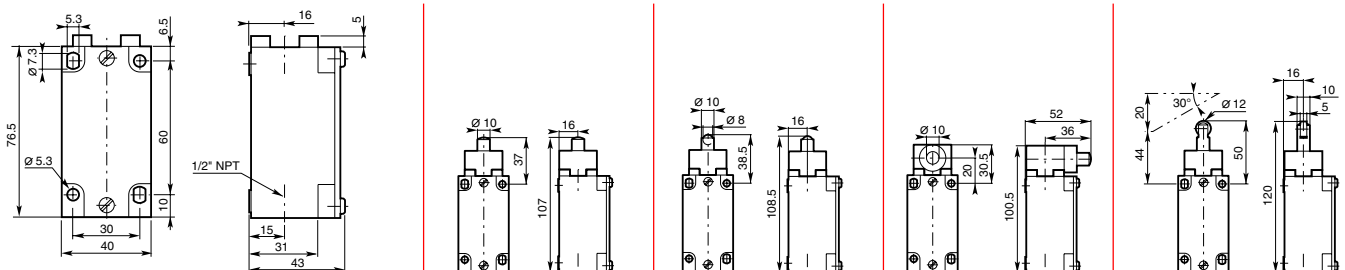

Technical data, 40mm

Metal casing, IP 66

1 Cable inlet for 1/2" NPT cable gland

Movement to be detected

30° Cam translation movement

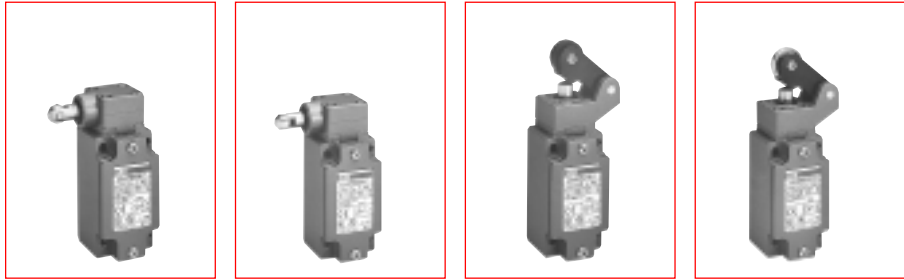

Operating head type

	Lateral plunger with vertical roller	Lateral plunger with horizontal roller	ø 22 Polyamide roller lever	ø 22 Stainless steel roller lever
Conformity / (N.C. contact with positive opening operation)	EN 50 041	EN 50 041		
Maximum actuation speed	0.5 m/s	0.5	1.5	1.5
Min. force: - actuation	N 30	30	12	12
- positive opening operation	N 70	70	40	40

Additional technical data

Metal limit switches

Snap action contacts	Catalog number	LS45M22B11	LS45M23B11	LS45M31B11	LS45M32B11
	Operation diagram				
Non-overlapping Slow action contacts	Catalog number	LS45M22D11	LS45M23D11	LS45M31D11	LS45M32D11
	Operation diagram				
Overlapping Slow action contacts	Catalog number	LS45M22C11	LS45M23C11	LS45M31C11	LS45M32C11
	Operation diagram				
Slow action contacts	Catalog number	LS45M22L02	LS45M23L02	LS45M31L02	LS45M32L02
	Operation diagram				
Slow action contacts	Catalog number	LS45M22L20	LS45M23L20	LS45M31L20	LS45M32L20
	Operation diagram				
Snap action contacts	Catalog number	LS45M22B02	LS45M23B02	LS45M31B02	LS45M32B02
	Operation diagram				
Weight (packing per unit)	kg	0.265	0.265	0.275	0.280

Dimensions (mm)

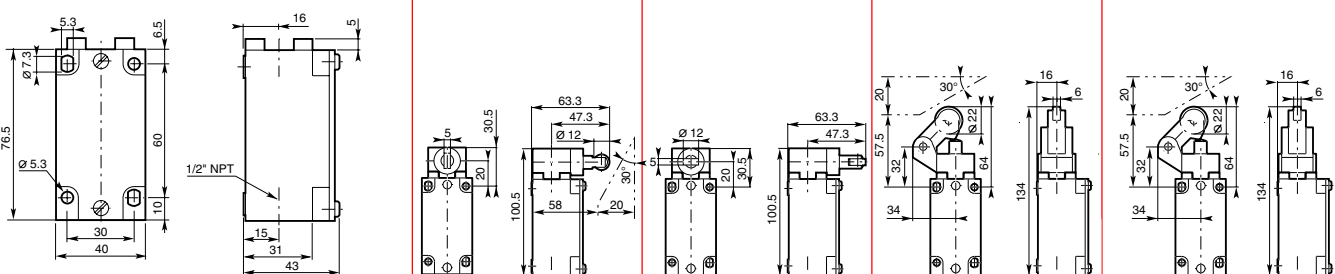

Technical data, 40mm

Metal casing, IP 66

1 Cable inlet for 1/2" NPT cable gland

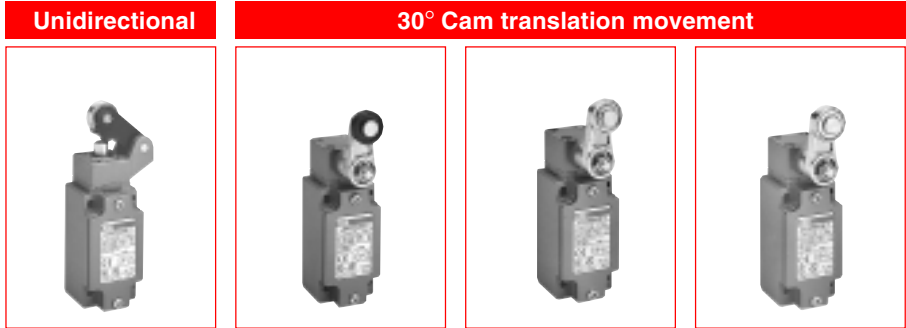

Movement to be detected



Operating head type

	ø 22 Ball-bearing roller lever	ø 22 Polyamide roller lever	ø 22 Stainless steel roller lever	ø 22 Ball-bearing roller lever
Conformity / \ominus (N.C. contact with positive opening operation)	EN 50 041 \ominus	EN 50 041 \ominus	EN 50 041 \ominus	EN 50 041 \ominus
Maximum actuation speed m/s	1.5	1.5	1.5	1.5
Min. force/torque: - actuation	12 N	0.15 N.m	0.15 N.m	0.15 N.m
- positive opening operation	40 N	0.44 N.m	0.44 N.m	0.44 N.m

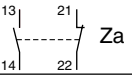
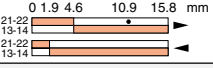
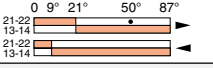
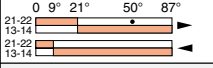
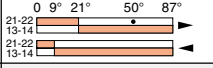
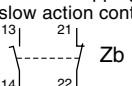
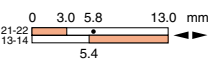
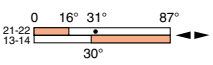
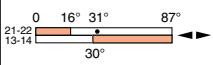
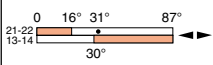
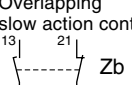
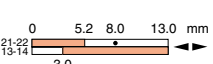
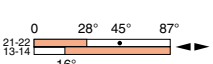
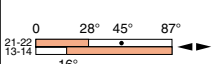
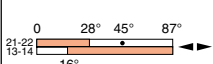
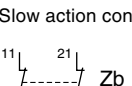
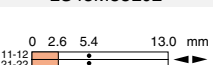
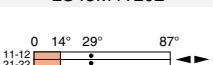
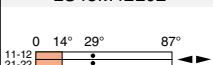
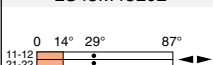
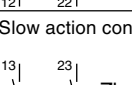
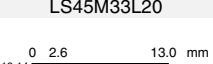
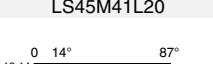
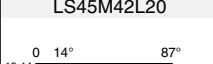
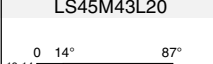
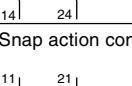
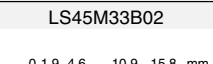
Additional technical data

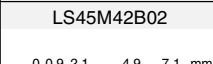
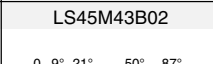
	Catalog number	LS45M33B11	LS45M41B11	LS45M42B11	LS45M43B11
Snap action contacts 	Operation diagram				
Non-overlapping slow action contacts 	Catalog number	LS45M33D11	LS45M41D11	LS45M42D11	LS45M43D11
Operation diagram					
Overlapping slow action contacts 	Catalog number	LS45M33C11	LS45M41C11	LS45M42C11	LS45M43C11
Operation diagram					
Slow action contacts 	Catalog number	LS45M33L02	LS45M41L02	LS45M42L02	LS45M43L02
Operation diagram					
Slow action contacts 	Catalog number	LS45M33L20	LS45M41L20	LS45M42L20	LS45M43L20
Operation diagram					
Snap action contacts 	Catalog number	LS45M33B02	LS45M41B02	LS45M42B02	LS45M43B02
Operation diagram					
Weight (packing per unit) kg		0.280	0.280	0.280	0.280

Metal limit switches

Dimensions (mm)

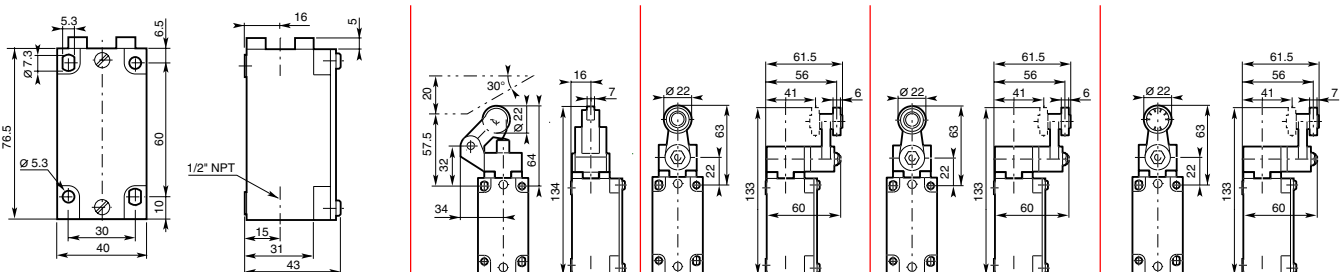

Technical data, 40mm

Metal casing, IP 66

1 Cable inlet for 1/2" NPT cable gland

Movement to be detected

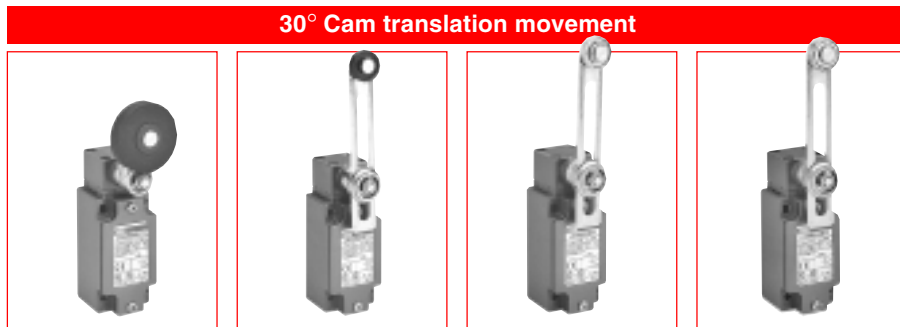

Operating head type

	ø 45 Rubber roller lever	Adjustable ø 22 polyamide roller lever	Adjustable ø 22 stainless steel roller lever	Adjustable ø 22 stainless steel ball-bearing roller lever
Conformity / ⊕ (N.C. contact with positive opening operation)	■	■	■	■
Maximum actuation speed	m/s 1.5	1.5	1.5	1.5
Min. torque: - actuation	N.m 0.15	0.15	0.15	0.15
- positive opening operation	N.m -	-	-	-

Additional technical data

Metal limit switches

Snap action contacts	Catalog number	LS45M44B11	LS45M51B11	LS45M52B11	LS45M53B11
	Operation diagram				
Non-overlapping slow action contacts	Catalog number	LS45M44D11	LS45M51D11	LS45M52D11	LS45M53D11
	Operation diagram				
Overlapping slow action contacts	Catalog number	LS45M44C11	LS45M51C11	LS45M52C11	LS45M53C11
	Operation diagram				
Slow action contacts	Catalog number	LS45M44L02	LS45M51L02	LS45M52L02	LS45M53L02
	Operation diagram				
Slow action contacts	Catalog number	LS45M44L20	LS45M51L20	LS45M52L20	LS45M53L20
	Operation diagram				
Snap action contacts	Catalog number	LS45M44B02	LS45M51B02	LS45M52B02	LS45M53B02
	Operation diagram				
Weight (packing per unit)	kg	0.310	0.290	0.300	0.300

Dimensions (mm)

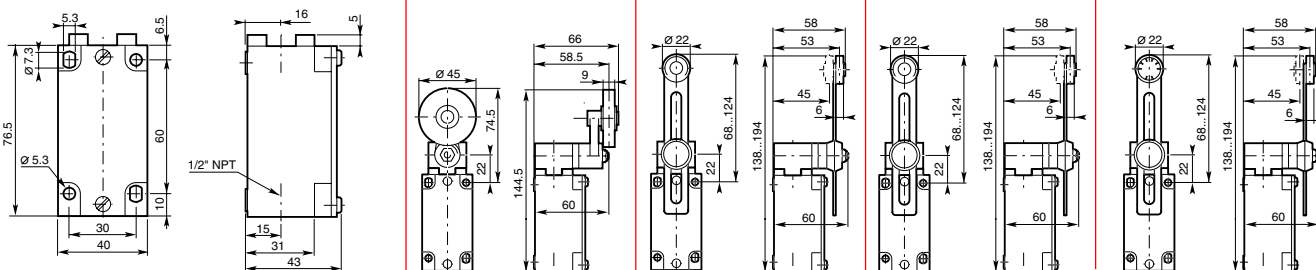

Technical data, 40mm

Metal casing, IP 66

1 Cable inlet for 1/2" NPT cable gland

Movement to be detected

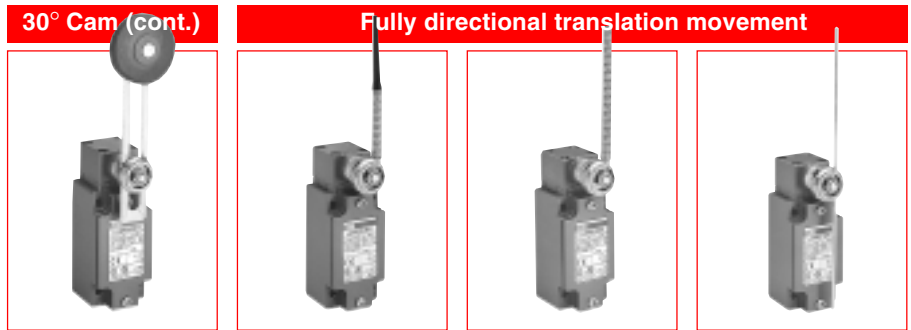

Operating head type

	Adjustable \varnothing 45 rubber roller lever	Flexible lever with insulated end	Coil spring lever	Adjustable \varnothing 3 stainless steel rod lever
Conformity / \ominus (N.C. contact with positive opening operation)				EN 50 041
Maximum actuation speed	m/s 1.5	1.5	1.5	0.5
Min. torque: - actuation	N.m 0.15	0.15	0.15	0.15
- positive opening operation	N.m -	-	-	-

Additional technical data

Snap action contacts	Catalog number	LS45M54B11	LS45M61B11	LS45M62B11	LS45M71B11
	Operation diagram				
Non-overlapping Slow action contacts	Catalog number	LS45M54D11	LS45M61D11	LS45M62D11	LS45M71D11
	Operation diagram				
Overlapping Slow action contacts	Catalog number	LS45M54C11	LS45M61C11	LS45M62C11	LS45M71C11
	Operation diagram				
Slow action contacts	Catalog number	LS45M54L02	LS45M61L02	LS45M62L02	LS45M71L02
	Operation diagram				
Slow action contacts	Catalog number	LS45M54L20	LS45M61L20	LS45M62L20	LS45M71L20
	Operation diagram				
Snap action contacts	Catalog number	LS45M54B02	LS45M61B02	LS45M62B02	LS45M71B02
	Operation diagram				
Weight (packing per unit)	kg	0.315	0.290	0.295	0.285

Dimensions (mm)

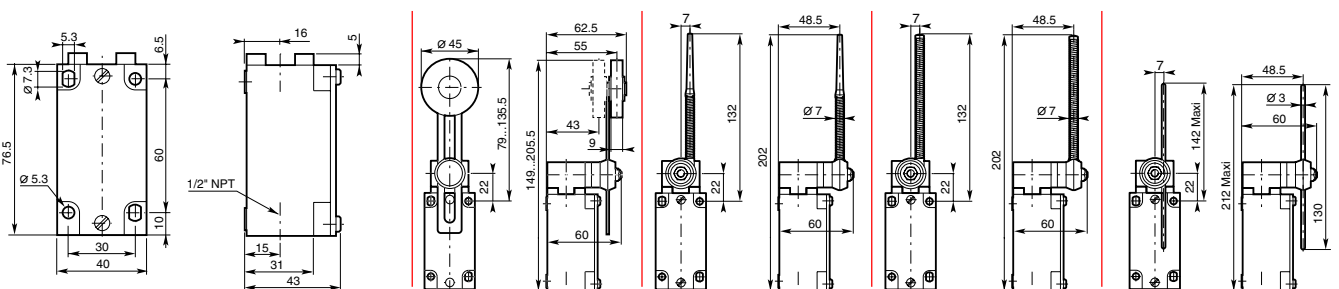

Technical data, 40mm

Metal casing, IP 66

1 Cable inlet for 1/2" NPT cable gland

Movement to be detected

Translation (cont.)

Multidirectional



Operating head type

	Adjustable Ø 6 polyamide rod lever	Spring rod	Flexible rod with insulated end	Coil spring rod
Conformity / \ominus (N.C. contact with positive opening operation)	EN 50 041			
Maximum actuation speed	1.5 m/s	1	1	1
Min. torque: - actuation	0.15 N.m	0.18	0.18	0.18
- positive opening operation	-	-	-	-

Additional technical data

	Catalog number	LS45M72B11	LS45M91B11	LS45M92B11	LS45M93B11
Snap action contacts 13 21 14 22 Za	Operation diagram				
Non-overlapping Slow action contacts 13 21 14 22 Zb	Catalog number	LS45M72D11	LS45M91D11	LS45M92D11	LS45M93D11
	Operation diagram				
Overlapping Slow action contacts 13 21 14 22 Zb	Catalog number	LS45M72C11	LS45M91C11	LS45M92C11	LS45M93C11
	Operation diagram				
Slow action contacts 11 21 12 22 Zb	Catalog number	LS45M72L02	LS45M91L02	LS45M92L02	LS45M93L02
	Operation diagram				
Slow action contacts 13 23 14 24 Zb	Catalog number	LS45M72L20	LS45M91L20	LS45M92L20	LS45M93L20
	Operation diagram				
Snap action contacts 11 21 12 22 Za	Catalog number	LS45M72B02	LS45M91B02	LS45M92B02	LS45M93B02
	Operation diagram				
Weight (packing per unit)	kg	0.285	0.235	0.235	0.235

Dimensions (mm)

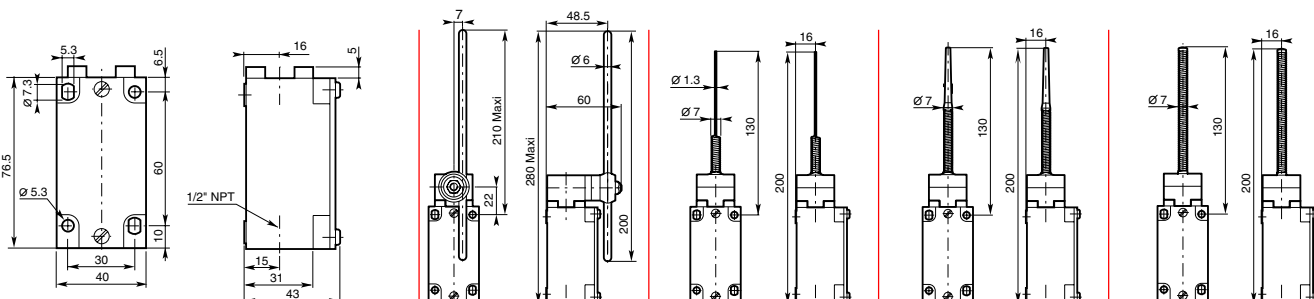



Limit Switches
Metal casing, 60mm
Technical data

Technical data, 60mm

Metal casing, IP 66

3 Cable inlets for 1/2" NPT cable gland

Movement to be detected

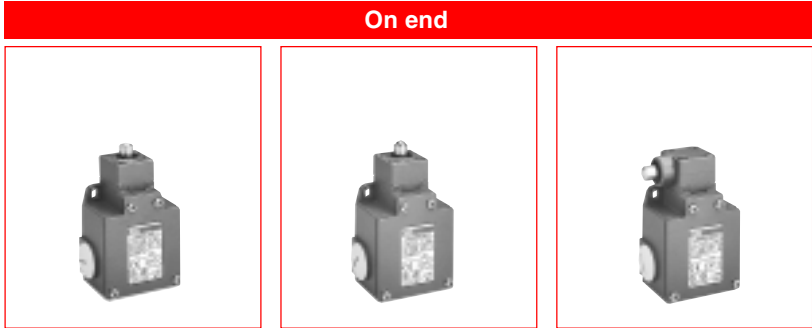

Operating head type

	Stainless steel plain plunger	Stainless steel ball plunger	Stainless steel lateral plain plunger
Conformity / ⊕ (N.C. contact with positive opening operation)	⊕	⊕	⊕
Maximum actuation speed m/s	0.5	0.5	0.5
Min. force: - actuation	22 N	22 N	30 N
- positive opening operation	66 N	66 N	70 N

Additional technical data

Metal limit switches



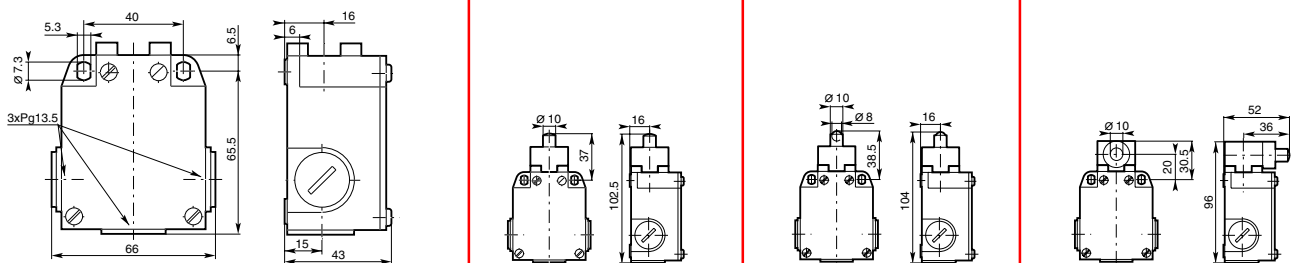

Snap action contacts 	Catalog number	LS65M11B11	LS65M12B11	LS65M21B11
Operation diagram				
Non-overlapping Slow action contacts 	Catalog number	LS65M11D11	LS65M12D11	LS65M21D11
Operation diagram				
Overlapping Slow action contacts 	Catalog number	LS65M11C11	LS65M12C11	LS65M21C11
Operation diagram				
Slow action contacts 	Catalog number	LS65M11L02	LS65M12L02	LS65M21L02
Operation diagram				
Slow action contacts 	Catalog number	LS65M11L20	LS65M12L20	LS65M21L20
Operation diagram				
Snap action contacts 	Catalog number	LS65M11B02	LS65M12B02	LS65M21B02
Operation diagram				
Weight (packing per unit)	kg	0.265	0.265	0.280



Dimensions (mm)



Technical data, 60mm
Metal casing, IP 66
3 Cable inlets for 1/2" NPT cable gland

30° Cam translation movement

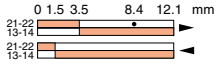
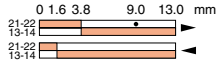
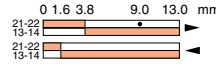
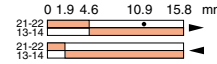
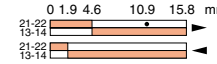
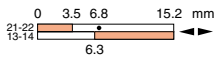
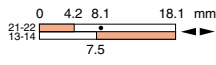
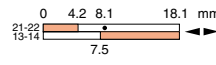
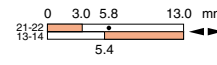
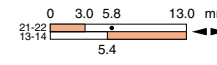
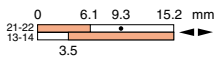
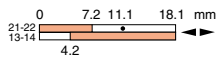
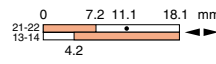
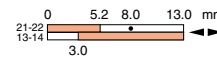
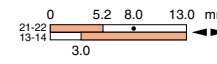
				
Stainless steel roller plunger	Lateral plunger with vertical roller	Lateral plunger with horizontal roller	ø 22 Polyamide roller lever	ø 22 Stainless steel roller lever
0.5 16 48	0.5 30 70	0.5 30 70	1.5 12 40	1.5 12 40

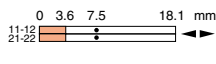
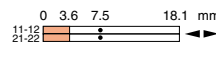
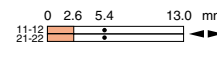
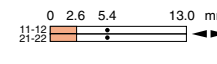
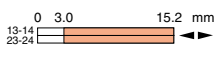
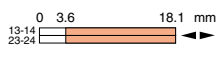
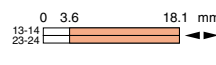
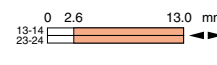
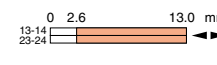
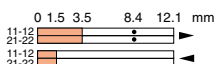
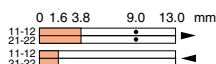
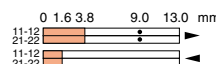
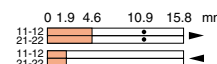
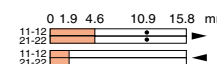
LS65M13B11  0 1.5 3.5 8.4 12.1 mm	LS65M22B11  0 1.6 3.8 9.0 13.0 mm	LS65M23B11  0 1.6 3.8 9.0 13.0 mm	LS65M31B11  0 1.9 4.6 10.9 15.8 mm	LS65M32B11  0 1.9 4.6 10.9 15.8 mm
LS65M13D11  0 3.5 6.8 15.2 mm 6.3	LS65M22D11  0 4.2 8.1 18.1 mm 7.5	LS65M23D11  0 4.2 8.1 18.1 mm 7.5	LS65M31D11  0 3.0 5.8 13.0 mm 5.4	LS65M32D11  0 3.0 5.8 13.0 mm 5.4
LS65M13C11  0 6.1 9.3 15.2 mm 3.5	LS65M22C11  0 7.2 11.1 18.1 mm 4.2	LS65M23C11  0 7.2 11.1 18.1 mm 4.2	LS65M31C11  0 5.2 8.0 13.0 mm 3.0	LS65M32C11  0 5.2 8.0 13.0 mm 3.0
LS65M13L02  0 3.0 6.3 15.2 mm	LS65M22L02  0 3.6 7.5 18.1 mm	LS65M23L02  0 3.6 7.5 18.1 mm	LS65M31L02  0 2.6 5.4 13.0 mm	LS65M32L02  0 2.6 5.4 13.0 mm
LS65M13L20  0 3.0 15.2 mm	LS65M22L20  0 3.6 18.1 mm	LS65M23L20  0 3.6 18.1 mm	LS65M31L20  0 2.6 13.0 mm	LS65M32L20  0 2.6 13.0 mm
LS65M13B02  0 1.5 3.5 8.4 12.1 mm	LS65M22B02  0 1.6 3.8 9.0 13.0 mm	LS65M23B02  0 1.6 3.8 9.0 13.0 mm	LS65M31B02  0 1.9 4.6 10.9 15.8 mm	LS65M32B02  0 1.9 4.6 10.9 15.8 mm
0.270	0.280	0.280	0.290	0.300

Metal limit switches

Dimensions (mm)

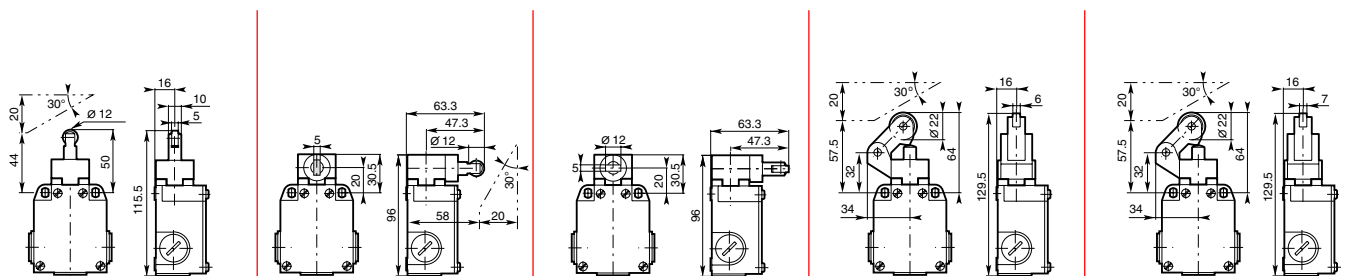

Technical data, 60mm

Metal casing, IP 66

3 Cable inlets for 1/2" NPT cable gland

30° Cam translation movement

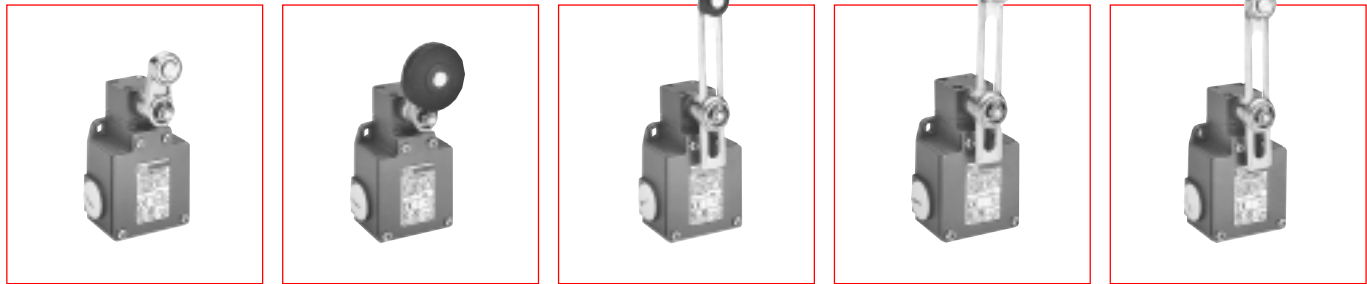

ø 22 Ball-bearing roller lever	ø 45 Rubber roller lever	Adjustable ø 22 polyamide roller lever	Adjustable ø 22 stainless steel roller lever	Adjustable ø 22 stainless steel ball-bearing roller lever
1.5 0.15 N.m 0.44 N.m	1.5 0.15 N.m -	1.5 0.15 N.m -	1.5 0.15 N.m -	1.5 0.15 N.m -

LS65M43B11 0 9° 21° 50° 87° 	LS65M44B11 0 9° 21° 87° 	LS65M51B11 0 9° 21° 87° 	LS65M52B11 0 9° 21° 87° 	LS65M53B11 0 9° 21° 87°
LS65M43D11 0 16° 31° 87° 30° 	LS65M44D11 0 16° 87° 30° 	LS65M51D11 0 16° 87° 30° 	LS65M52D11 0 16° 87° 30° 	LS65M53D11 0 16° 87° 30°
LS65M43C11 0 28° 45° 87° 16° 	LS65M44C11 0 28° 87° 16° 	LS65M51C11 0 28° 87° 16° 	LS65M52C11 0 28° 87° 16° 	LS65M53C11 0 28° 87° 16°
LS65M43L02 0 14° 29° 87° 	LS65M44L02 0 14° 87° 	LS65M51L02 0 14° 87° 	LS65M52L02 0 14° 87° 	LS65M53L02 0 14° 87°
LS65M43L20 0 14° 87° 	LS65M44L20 0 14° 87° 	LS65M51L20 0 14° 87° 	LS65M52L20 0 14° 87° 	LS65M53L20 0 14° 87°
LS65M43B02 0 9° 21° 50° 87° 	LS65M44B02 0 9° 21° 87° 	LS65M51B02 0 9° 21° 87° 	LS65M52B02 0 9° 21° 87° 	LS65M53B02 0 9° 21° 87°
0.305	0.330	0.315	0.325	0.325

Metal limit switches

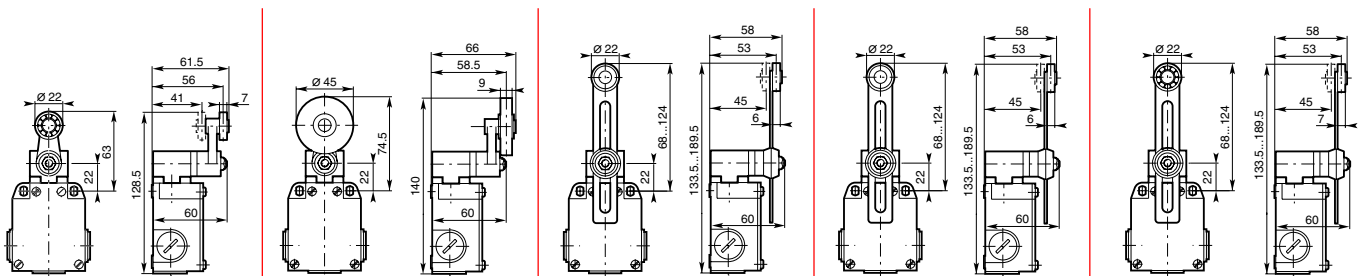

Technical data, 60mm

Metal casing, IP 66

3 Cable inlets for 1/2" NPT cable gland

Movement to be detected



Operating head type

		Adjustable \varnothing 45 rubber roller lever	Flexible lever with insulated end	Coil spring lever
Conformity / \ominus (N.C. contact with positive opening operation)				
Maximum actuation speed	m/s	1.5	1.5	1.5
Min. torque: - actuation	N.m	0.15	0.15	0.15
- positive opening operation	N.m	-	-	-

Additional technical data

	Catalog number	LS65M54B11	LS65M61B11	LS65M62B11
Snap action contacts 13 21 14 22 Za	Operation diagram			
Non-overlapping Slow action contacts 13 21 14 22 Zb	Catalog number	LS65M54D11	LS65M61D11	LS65M62D11
	Operation diagram			
Overlapping Slow action contacts 13 21 14 22 Zb	Catalog number	LS65M54C11	LS65M61C11	LS65M62C11
	Operation diagram			
Slow action contacts 11 21 12 22 Zb	Catalog number	LS65M54L02	LS65M61L02	LS65M62L02
	Operation diagram			
Slow action contacts 13 23 14 24 Zb	Catalog number	LS65M54L20	LS65M61L20	LS65M62L20
	Operation diagram			
Snap action contacts 11 21 12 22 Za	Catalog number	LS65M54B02	LS65M61B02	LS65M62B02
	Operation diagram			
Weight (packing per unit)	kg	0.335	0.320	0.325



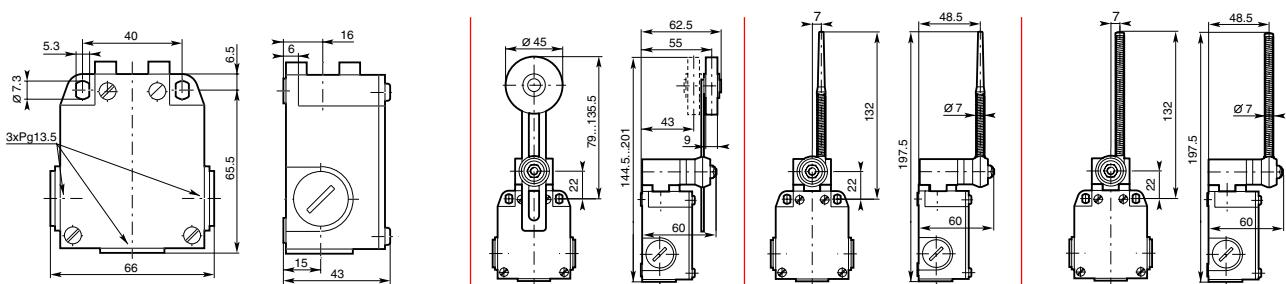

Dimensions (mm)







Technical data, 60mm

Metal casing, IP 66

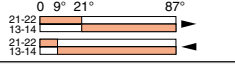
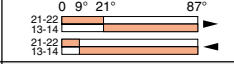
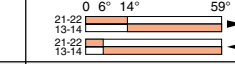
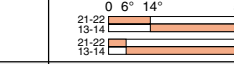
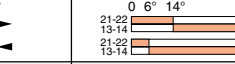
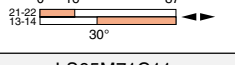
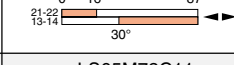
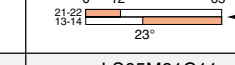
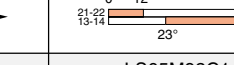
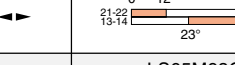
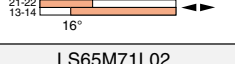
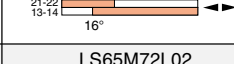
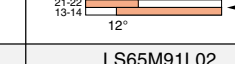
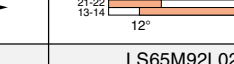
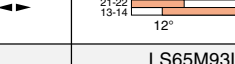
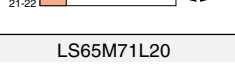
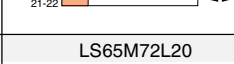
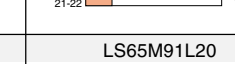
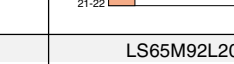
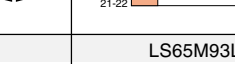
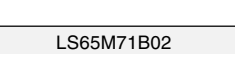
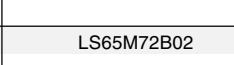
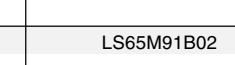
3 Cable inlets for 1/2" NPT cable gland

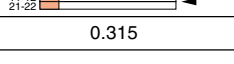
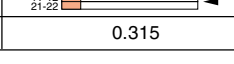
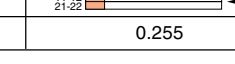
Fully directional translation movement		Multidirectional		
				
Adjustable \varnothing 3 stainless steel rod lever	Adjustable \varnothing 6 polyamide rod lever	Spring rod	Flexible rod with insulated end	Coil spring rod
1.5 0.15 -	1 0.15 -	1 0.18 -	1 0.18 -	1 0.18 -

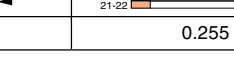
LS65M71B11  0 9° 21° 87° 21-22 13-14 13-14	LS65M72B11  0 9° 21° 87° 21-22 13-14 13-14	LS65M91B11  0 6° 14° 59° 21-22 13-14 13-14	LS65M92B11  0 6° 14° 59° 21-22 13-14 13-14	LS65M93B11  0 6° 14° 59° 21-22 13-14 13-14
LS65M71D11  0 16° 87° 21-22 13-14 30°	LS65M72D11  0 16° 87° 21-22 13-14 30°	LS65M91D11  0 12° 65° 21-22 13-14 23°	LS65M92D11  0 12° 65° 21-22 13-14 23°	LS65M93D11  0 12° 65° 21-22 13-14 23°
LS65M71C11  0 28° 87° 21-22 13-14 16°	LS65M72C11  0 28° 87° 21-22 13-14 16°	LS65M91C11  0 21° 65° 21-22 13-14 12°	LS65M92C11  0 21° 65° 21-22 13-14 12°	LS65M93C11  0 21° 65° 21-22 13-14 12°
LS65M71L02  0 14° 87° 11-12 21-22	LS65M72L02  0 14° 87° 11-12 21-22	LS65M91L02  0 11° 65° 11-12 21-22	LS65M92L02  0 11° 65° 11-12 21-22	LS65M93L02  0 11° 65° 11-12 21-22
LS65M71L20  0 14° 87° 13-14 23-24	LS65M72L20  0 14° 87° 13-14 23-24	LS65M91L20  0 11° 65° 13-14 23-24	LS65M92L20  0 11° 65° 13-14 23-24	LS65M93L20  0 11° 65° 13-14 23-24
LS65M71B02  0 9° 21° 87° 11-12 21-22 11-12 21-22	LS65M72B02  0 9° 21° 87° 11-12 21-22 11-12 21-22	LS65M91B02  0 6° 14° 59° 11-12 21-22 11-12 21-22	LS65M92B02  0 6° 14° 59° 11-12 21-22 11-12 21-22	LS65M93B02  0 6° 14° 59° 11-12 21-22 11-12 21-22
0.315	0.315	0.255	0.260	0.255

Metal limit switches

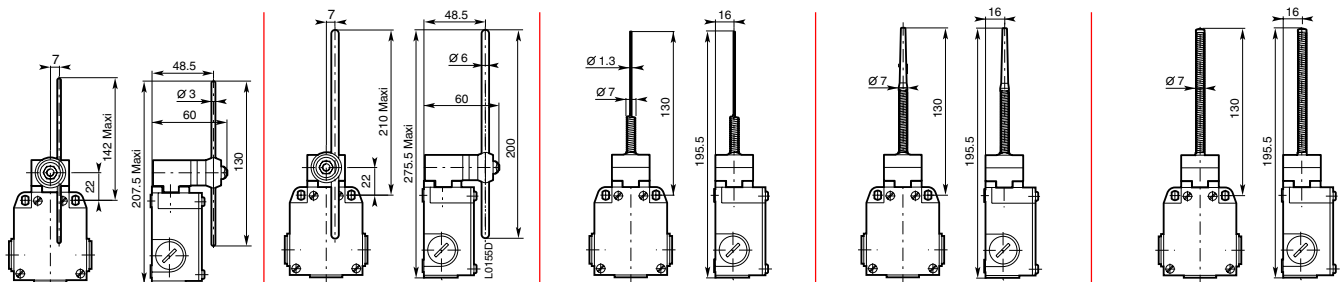

Notes



Foot switches

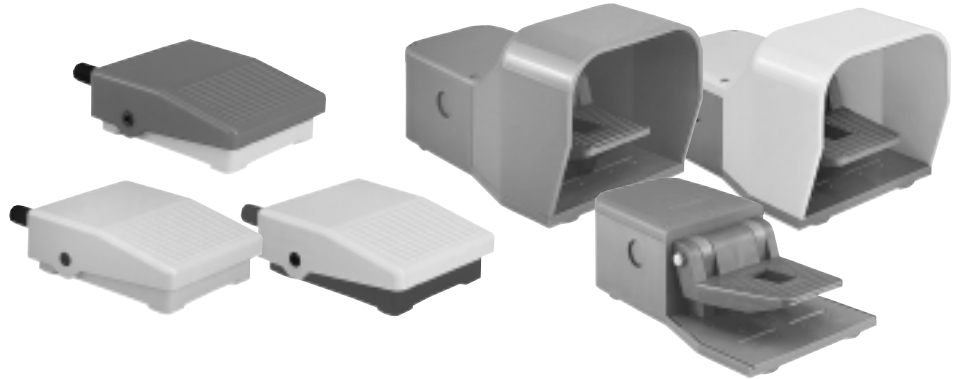

Description of Mini foot switches

- Reduced dimensions: 100 x 75 x 34 mm.
- Materials: cover and base made of self-extinguishing ABS.
- Color choice: black or grey base; black, grey, yellow or red cover.

Description of foot switches with covers

- Dimensions: 285 x 140 x 145.
- Materials: base, cover and pedal made of shock resistant Bayblend® FR 90 material (alloyed polycarbonate and ABS).
- Color choice: grey base; grey, yellow or red cover.
- Variations: grey base, half-red cover. Especially used for emergency stop function.

Note: this emergency stop function must never contain the «locked in neutral position» device.

UL Listed file #E191693

Application

Foot switch-operated machines such as: shearing machines, folding machines, spinning lathes, machine tools, wrapping machines, riveting presses, etc.

Foot switches with covers come in three operation formats:

- **Free movement:** contact position follows pedal movement: actuated when the pedal is pushed down, released when pedal is in a state of rest.
- **Foot switch locked in neutral position:** same operation as above, after unlocking the pedal with the end of the foot.
- **Foot switch latched in low position:** same operation as free movement, except that a state of rest is obtained only after having unlatched the pedal with the end of the foot.

Foot switches

IPM Mini foot switches, IPS Foot switches with covers

Description

Application

Foot switch-operated machines such as: shearing machines, folding machines, spinning lathes, machine tools, wrapping machines, riveting presses, etc.

Foot switches with covers come in three operation formats:

- **Free movement:** contact position follows pedal movement: actuated when the pedal is pushed down, released when pedal is in a state of rest.
- **Foot switch locked in neutral position:** same operation as above, after unlocking the pedal with the end of the foot.
- **Foot switch latched in low position:** same operation as free movement, except that a state of rest is obtained only after having unlatched the pedal with the end of the foot.

Description of Mini foot switches

- Reduced dimensions: 100 x 75 x 34 mm.
- Materials: cover and base made of self-extinguishing ABS.
- Color choice: black or grey base; black, grey, yellow or red cover.

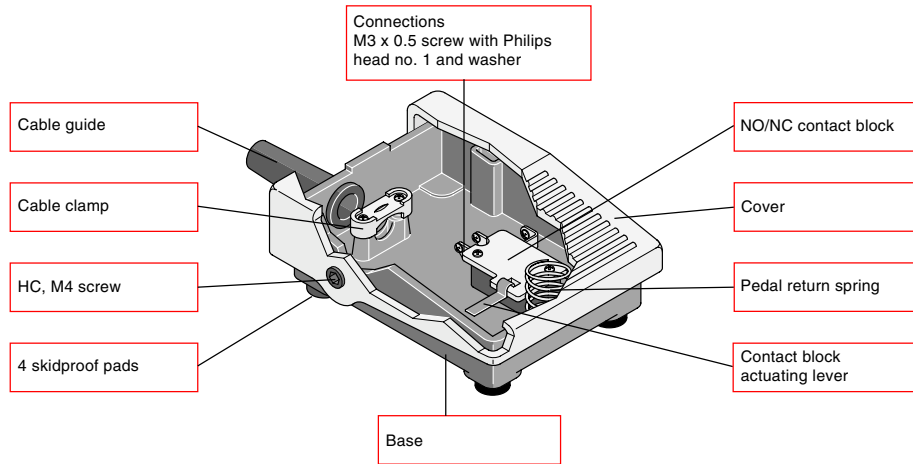

Description of foot switches with covers

- Dimensions: 285 x 140 x 145.
- Materials: base, cover and pedal made of shock resistant Bayblend® FR 90 material (alloyed polycarbonate and ABS).
- Color choice: grey base; grey, yellow or red cover.
- Variations: grey base, half-red cover. Especially used for emergency stop function.

Note: this emergency stop function must never contain the «locked in neutral position» device.

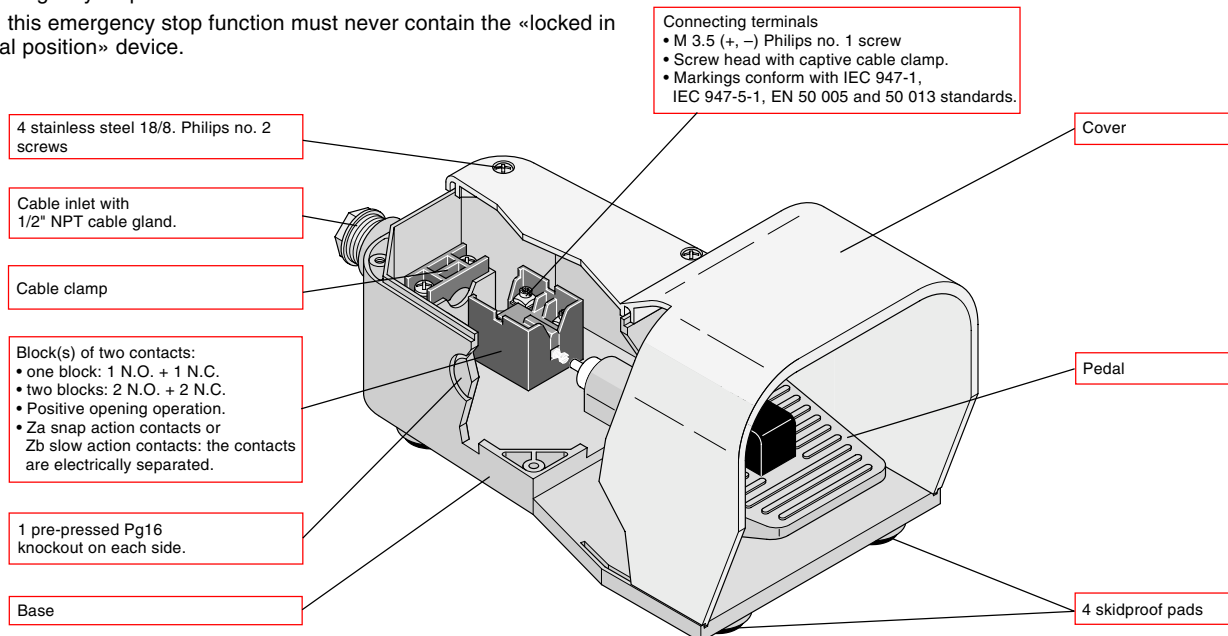

Comment: Foot switches with covers can be assembled on a plate and equipped with a transportation handle. Upon request, instead of the handle an emergency stop button can be installed above a tube that allows for connection cable passage.

Foot switches

Mini foot switches

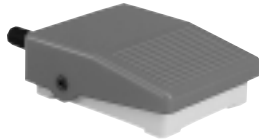

IPM1R

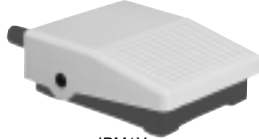

IPM1Y



IPM1G

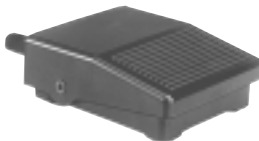

IPM1B

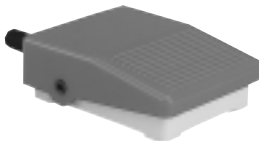

IPM1R

IPM Mini foot switches

		Cover color	Unit weight in kg Packing 1 piece	Catalog number	List price
Black base					
1		Yellow	0.130	IPM1Y	\$ 28
1		Grey	0.130	IPM1G	
1		Black	0.130	IPM1B	
1		Red	0.130	IPM1R	
Grey base					
1		Yellow	0.130	IPM2Y	28
1		Grey	0.130	IPM2G	
1		Black	0.130	IPM2B	
1		Red	0.130	IPM2R	

Catalog number explanation

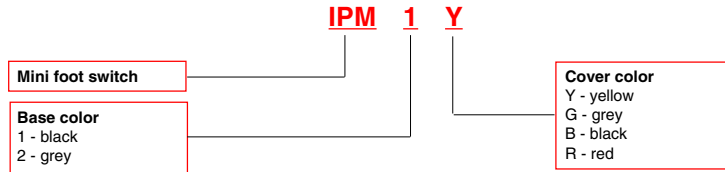

Foot switches

Foot switches with covers



IPSY1A11



IPSR1A11



IPSG1A11

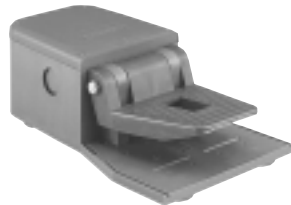

IPSZ1A11

IPS foot switches

Contact blocks				Unit weight in kg	Catalog number	List price
Snap action		Non-overlapping slow action				
Za	Za	Zb	Zb	Packing 1 piece		
Free movement						
1	—	—	—	1.100	IPS★1A11	\$ 76
—	—	1	—	1.100	IPS★1D11	76
—	1 + 1	—	—	1.100	IPS★1A22	88
—	—	—	1 + 1	1.100	IPS★1D22	88
Locked in neutral position						
1	—	—	—	1.100	IPS★2A11	83
—	—	1	—	1.100	IPS★2D11	83
—	1 + 1	—	—	1.100	IPS★2A22	91
—	—	—	1 + 1	1.100	IPS★2D22	91
Latched in low position						
1	—	—	—	1.100	IPS★3A11	81
—	—	1	—	1.100	IPS★3D11	81
—	1 + 1	—	—	1.100	IPS★3A22	93
—	—	—	1 + 1	1.100	IPS★3D22	93
Free movement foot switch with half-red cover						
1	—	—	—	0.800	IPSZ1A11	85
—	—	1	—	0.800	IPSZ1D11	85
—	1 + 1	—	—	0.800	IPSZ1A22	97
—	—	—	1 + 1	0.800	IPSZ1D22	97
Foot switch latched in low position with half-red cover						
1	—	—	—	0.800	IPSZ3A11	90
—	—	1	—	0.800	IPSZ3D11	90
—	1 + 1	—	—	0.800	IPSZ3A22	102
—	—	—	1 + 1	0.800	IPSZ3D22	102

Color code

To select a foot switch color, substitute the appropriate color code for the ★ in the catalog number

Yellow	Y
Grey	G
Red	R

Catalog number explanation

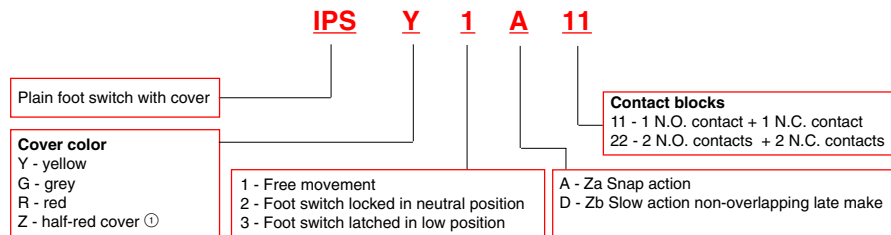

① Incompatible with locked in neutral position function.

Technical data

General technical data

		Mini foot switch	Foot switch with cover
Standards		IEC 1058-1	IEC 947-5-1
Certifications & Approvals		—	UL - CSA - BG
Air temperature near the device			
– during operation	°C	– 10 ... + 70	– 10 ... + 70
– for storage	°C	– 25 ... + 80	– 30 ... + 80
Climatic withstand		—	according to IEC 68-2-3 and salty mist according to IEC 68-2-11
Shock withstand (according to IEC 68-2-27 and EN 60 068-2-27)		g	50g (1/2 sinusoidal shock for 11 ms) no change in contact position
Degree of protection (according to IEC 529 and EN 60 529)		IP 40	IP 65
Actuation torque		N.m	1.2
Operating angle		Degree	2 to 4
Cable inlet		Cable guide ø min. 6mm; ø max. 8.5 mm	Pg 16

Electrical data

Rated insulation voltage U_i		V	250	500 (according to IEC 947-1 and EN 60-947-1) Degree of pollution 3
Rated impulse withstand voltage U_{imp} (according to IEC 947-1 and EN 60 947-1)		kV	1	6
Conventional free air thermal current I_{th} ($q < 40$ °C)		A	15	10 (according to IEC 947-1)
Short-circuit protection $U_o < 500$ V a.c. - gG (gl) type fuses		A	10	10
Rated operational current		A	3 (250 V a.c.) 0.06 (230 V d.c.)	A 600 (according to UL 508 and CSA C22-2 n° 14) Q 600 (according to UL 508 and CSA C22-2 n° 14)
AC-15 acc. to IEC 947-5-1	24 V	A	—	10
	130 V	A	—	5.5
	230 V	A	—	3.1
	240 V	A	—	3
	400 V	A	—	1.8
DC-13 acc. to IEC 947-5-1	24 V	A	—	2.8
	110 V	A	—	0.6
	250 V	A	—	0.27
Resistance between contacts		mΩ	30	25
Connecting terminals			M3 x 0.5 screw with Philips head no. 1 and washer	M3.5 (+, -) screw with Philips head no. 1 with cable clamp
Positive opening operation (according to IEC 947-5-1)			—	⊕
Connecting capacity		1 or 2 x mm ²	—	0.5 – 2.5
Terminal marking			(Refer to contact blocks page 66)	According to EN 50 013
Mechanical durability		Millions of operations	10	30
Electrical durability		Operations	100,000	According to IEC 947-5-1, utilization categories AC-15 and DC-13 (Load factor of 0.5 according to curves below)

AC-15 — Snap action

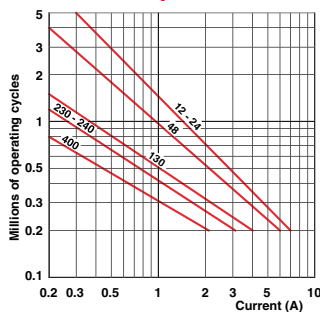

AC-15 — Slow action

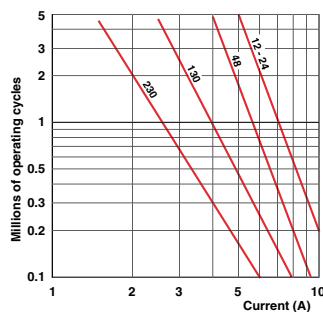

DC-13	Snap action	Slow action
Power breaking for a durability of 5 million operating cycles		
Voltage	24 V	12 W
Voltage	48 V	9 W
Voltage	110 V	6 W

Technical data

Mini-footswitches

IPM Mini foot switches

Base color		Yellow cover	Grey cover	Black cover	Red cover
Black base	Catalog number	IPM1Y	IPM1G	IPM1B	IPM1R
Grey base	Catalog number	IPM2Y	IPM2G	IPM2B	IPM2R
Weight (packing per unit)	kg	0.130	0.130	0.130	0.130

N.O. + N.C. Contact block

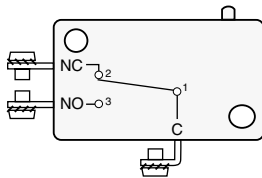

Dimensions (mm)

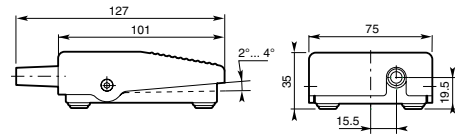

Technical data

Foot switches with covers

IPS Foot switches

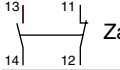
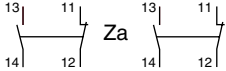
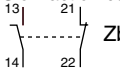
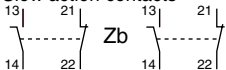
		Free movement	Locked in neutral position	Latched in low position
Snap action contacts	Catalog number	IPS★1A11	IPS★2A11	IPS ★3A11
	⊖ (Positive opening operation of the N.C. contact)	⊖	⊖	⊖
Snap action contacts	Catalog number	IPS★1A22	IPS★2A22	IPS★3A22
	⊖ (Positive opening operation of the N.C. contact)	⊖	⊖	⊖
Non-overlapping Slow action contacts	Catalog number	IPS★1D11	IPS★2D11	IPS★3D11
	⊖ (Positive opening operation of the N.C. contact)	⊖	⊖	⊖
Non-overlapping Slow action contacts	Catalog number	IPS★1D22	IPS★2D22	IPS★3D22
	⊖ (Positive opening operation of the N.C. contact)	⊖	⊖	⊖
Weight (packing per unit)	kg	1.10	1.10	1.10

Dimensions (mm)

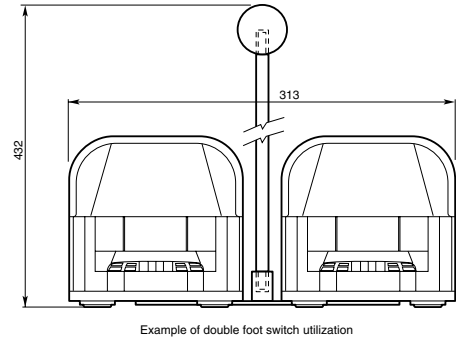
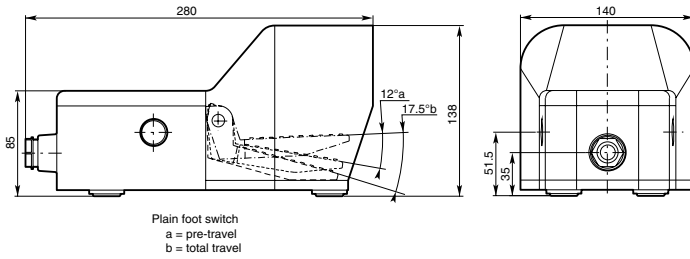

Notes

Terms & conditions

These terms and conditions govern all sales and shipments of control equipment products (including parts and accessories).

ABB Control Inc. hereby gives notice of its objection to any different or additional terms and conditions except for such as may be expressly accepted by it in writing.

Prices

Prices are subject to change without notice. Prices will be the prices in effect at the time of shipment by ABB Control Inc. and include freight, prepaid and allowed to first destination in the continental United States. In the event of a price change, the effective date of the change will be the date shown on the new price discount sheets. However, where a price change is made by letter or telegram, the effective date will be given as part of the announcement.

Taxes

The price does not include any Federal, state or local property, license, privilege, sales, use, excise, gross receipts or other like taxes which may now or hereafter be applicable. Payment by ABB Control Inc. of any such taxes shall be for the account of purchaser.

Standard Terms of Payment

Standard terms of payment are according to the appropriate discount schedule (AC 5000 - AC 5002).

Payment and Late Charges

ABB Control Inc. may require full or partial payment in advance if, in its sole judgement, the financial condition of the purchaser, at any time prior to delivery, does not merit the terms of payment specified.

If shipments are delayed by the purchaser or by reason of any of the causes referred to in the paragraph entitled "Excusable Delay", payments shall become due from the date when ABB Control Inc. is prepared to make shipment. Products held for the purchaser as a result of such delay shall be at the risk and expense of the purchaser.

If the purchaser fails to pay any invoice when due, ABB Control Inc. may defer deliveries under this or any other contract with purchaser, except upon prior receipt of satisfactory security for or cash in payment of any such invoice. Failure on the part of purchaser to pay invoices when due shall at the option of ABB Control Inc. constitute a default under this contract.

A service charge, the lesser of the highest rate allowed by law or 11/2% per month, or fraction thereof, for a maximum charge of 18% per annum will be charged on all overdue accounts.

Delivery

Delivery of products shall be FOB point of shipment regardless of transportation costs being "allowed", "prepaid" or "collect". Where the scheduled delivery of products and parts is delayed by the purchaser or by reason of any of the causes referred to in the paragraph entitled Excusable Delay, ABB Control Inc. may deliver such products by moving them to storage for the account of and at the risk of the purchaser. Shipping dates are approximate and are based upon prompt receipt of all necessary information from purchaser. ABB Control Inc. reserves the right to make delivery in installments.

Purchaser Pick-up

No allowance will be made in lieu of transportation charges if the purchaser accepts shipment at the factory, warehouse or freight station. Transportation charges will not be deducted from the purchase price.

Origin, Method of Shipment and Routing

ABB Control Inc. shall determine the point of origin of shipment, the method of transportation and the routing of shipment. Costs for shipment by means requested by purchaser different from ABB Control Inc.'s standard means of shipment are invoiced to the purchaser as a separate charge.

Freight charges will be added to the price of any order under \$100.

Excusable Delay

ABB Control Inc. shall not be liable for loss, damage, detention or delay, nor be deemed to be in default from causes beyond its reasonable control, including without limitation, fire, flood, strike or other labor difficulty, act or omission of any governmental authority or of the purchaser, insurrection or riot, embargo, delays or shortage in transportation or inability to obtain necessary labor, materials or manufacturing facilities from usual sources.

In the event of delay in performance due to any such cause, the date of delivery will be postponed by such length of time as may be reasonably necessary to compensate for the delay.

Warranty

ABB Control Inc. warrants that on date of shipment to purchaser, the goods will be the kind and quality described herein, merchantable and free of defects in

workmanship and material.

If within one year from date of initial operation, but not more than eighteen months from date of shipment, should any failure to conform with this warranty appear within such time, ABB Control Inc. shall, if given prompt notice by purchaser, correct such nonconformity, at its option, either by repair or replacement F.O.B. repair facility or by refund of the purchase price of the nonconforming product or part. Return of products to ABB Control Inc. pursuant to this paragraph shall be at purchaser's risk and expense. *The foregoing warranty is exclusive and in lieu of all other warranties of quality, expressed or implied, and all other warranties, including any warranty of merchantability or fitness for a particular purpose are hereby disclaimed.*

Correction of nonconformities in the manner and for the period of time provided above shall be purchaser's exclusive remedy and shall constitute fulfillment of all liabilities of ABB Control Inc. whether in warranty, strict liability, contract, negligence, tort or otherwise with respect to any nonconformance or defect in the product.

The foregoing warranty shall not apply to any product which has been: a) improperly repaired or altered, b) subjected to misuse, misapplication, negligence or accident, c) used in a manner contrary to manufacturer's directions.

Limitation of Liability

ABB Control Inc.'s liability to purchaser on any claim in connection with the product shall not exceed the purchase price of the product which gives rise to the claim.

IN NO EVENT SHALL ABB CONTROL INC. BE LIABLE FOR SPECIAL, INCIDENTAL OR CONSEQUENTIAL DAMAGES whether in warranty, contract, strict liability, tort, negligence or otherwise including but not limited to loss of profits or revenue, loss of use of the product or any associated product, cost of capital, cost of substitute products, facilities or services, downtime costs or claims of customers of the purchaser for such or other damages.

Except as prohibited by law, all causes of action against ABB Control Inc. shall expire unless brought within one year of the time of accrual thereof. *ABB CONTROL INC. NEITHER ASSUMES NOR AUTHORIZES ANYONE TO ASSUME FOR IT ANY OTHER OR FURTHER LIABILITY THAN AS SET OUT ABOVE.*

Patent Indemnity

ABB Control Inc. will at its own expense defend any suit which may be brought against the Purchaser based on a claim that any apparatus or part furnished under contract constitutes an infringement of any United States letter patent (provided ABB Control Inc. is notified promptly of such suit and copies of all papers therein are delivered to ABB Control Inc.), and ABB Control Inc. agrees to pay all judgements and costs recovered in any such suit and to reimburse the Purchaser for costs of expenses incurred in the defense of any such claim or suit. In case said apparatus or any part is held to constitute infringement and the use of the apparatus or part is enjoined, ABB Control Inc. shall at its own expense, either procure for the Purchaser the right to continue using the apparatus or part or replace it with non-infringing apparatus; or modify it so it becomes non-infringing, or remove the apparatus and refund the purchase price and the transportation and installation cost thereof. The foregoing states the entire liability of ABB Control Inc. for patent infringement by apparatus or any part thereof.

Shipping loss or damage

In the event of shipping loss or damage: 1) Notification must be given to ABB Control Inc. within 72 hours of delivery; 2) Written notice of apparent loss or damage must be made on the carrier's delivery receipt; and 3) Concealed damage must be immediately reported to the delivering carrier with a request for inspection. Purchaser shall comply with the foregoing procedure whether or not ABB Control Inc. has the risk of loss at the point of loss or damage to the shipment.

Title – risk of loss

The products sold hereunder shall remain the property of ABB Control Inc. and shall remain personal property until fully paid for in cash, and purchaser agrees, if requested by ABB Control Inc. to execute a further security agreement covering the products sold, and to perform all acts which may be necessary to perfect and assure retention of title to such products by ABB Control Inc. Notwithstanding any agreement with respect to delivery terms, risk of loss or damage shall pass to the purchaser and delivery shall be deemed to be complete upon delivery to a private or common carrier or upon moving into storage, whichever occurs first, at the point of shipment.

Termination

Any order or contract may be terminated by the purchaser only on written notice and upon payment of reasonable and proper termination charges, including without limitation, all costs identified to the order of contract incurred by ABB Control Inc. up to the date of notice of termination and all charges incurred by ABB Control Inc. in respect of the termination.

Terms & conditions

Returns

In no event will ABB Control Inc. be responsible for unauthorized return of products. Returns will be accepted only at ABB Control Inc.'s option and subject to terms specified by ABB Control Inc. Authorization and shipping instructions for return of products must be obtained from ABB Control Inc. prior to return shipment. Product must be returned with proper identification. When a purchaser requests authorization to return for his own reasons, the return is subject to a minimum restocking charge of 20% for standard inventoried product and for any transportation paid by ABB Control Inc., both out and ingoing. Returns will be accepted up to 60 days after invoice date. Goods returned for purchaser's reason are subject to inspection and must be in good working condition, as new, and in original cartons.

Purchase orders

Except as provided below, all orders must be in writing and show quantities and prices, complete description (including catalog numbers) of products requested and mutually agreed delivery dates.

Verbal orders received via telephone or otherwise must be confirmed within 5 days either by mail, telex or the equivalent. Verbal orders with a purchase price over \$5,000 will not be processed until such written confirmation is received.

Unless otherwise agreed in writing, an addition to a previously entered order will be accepted only at then applicable prices, discount schedules, conditions of sale, etc.

Special quotations

Special quotations will automatically expire 30 days from issuance unless renewed in writing by ABB Control Inc.

Assignment

Any assignment of this contract, or any rights hereunder, without prior written consent of ABB Control Inc. by a duly authorized representative thereof shall be void.

Partial invalidity

If any provisions herein or portions thereof conflict with any statute or rule of law of the jurisdiction of applicable law or wherein the contract may be sought to be enforced, then such provisions or portions thereof shall be deemed void to the extent that they may so conflict, but without invalidating the remaining portions of such provisions or other provisions hereof.

Remedies

The remedies expressly provided for in the Conditions of Sale shall be in addition to any other remedies which ABB Control Inc. may have under the Uniform Commercial Code or other applicable law.

Choice of law

The construction and performance of this contract and the rights and remedies of the parties hereto shall be governed by the laws of the State of Texas.

Notes



Notes

Notes



Notes

Notes



Standard compliance and approvals

The CE Mark

Worldwide approvals^①



The CE Mark

Within the European Union, EU, conformity of products and the proper application of the CE marking to machines and control equipment is necessary for marketing electrical equipment. The intent is to ensure compliance with all relevant EU Directives.

ABB Low Voltage Apparatus

ABB is a global group serving customers in electric power generation, transmission and distribution, industrial building systems, and rail transportation. ABB Low Voltage Apparatus develops, produces and markets low voltage products such as disconnect switches, contactors, starters, pushbuttons, soft starters, arc guard systems, relays, mini-contactors, manual motor starters, Isomax MCCBs, and

MCCBs. With six manufacturing units within the European Union, we are ideally located to develop, manufacture and provide low voltage equipment to comply with the EU directive.

Background

The guarantee of free trade of goods within the Community is the most important objective. This will eliminate trade restrictions that result from different technical regulations in each individual member country. Harmonization of existing European standards and regulations, is being accomplished and already partially realized. Based on this goal, a new concept for creating directives was formed in 1985 by the European Community (EC) Commission to produce directives with a wide range of application which contain only the most basic safety requirements.

The CE Mark

The CE mark is prescribed by law and assures the European free trade of goods. It is short for "Communauté Européen", and is displayed on goods and/or packaging which acts as an external symbol for the inspection of products. It also illustrates the manufacturer's responsibility to uphold the community's directives.

ABB's commitment to the directives

ABB Low Voltage Apparatus producing companies will attach the CE mark in accordance with the product directives. Our products will conform as follows:

- Declarations of conformity for ABB products will be available when required by the relevant EU directives.
- Those products required to do so will bear CE marking as specified by the relevant EU directives and CE marking regulations.
- Necessary technical documentation will be on file and made available to authorized organizations upon written request.

^① Approvals listed may not apply to products listed in this publication.



ABB Control Inc.
Low Voltage Products and Systems
1206 Hatton Road
Wichita Falls, TX 76302
Tel. 888-385-1221
940-397-7000
Fax 940-397-7085

AC 1300
August, 2000