

Project: \_\_\_\_\_

Fixture Type: \_\_\_\_\_

Location: \_\_\_\_\_

Contact/Phone: \_\_\_\_\_

# 4" IC AND TC 1000 LUMEN INTERNALLY ADJUSTABLE LED DOWNLIGHT NEW CONSTRUCTION

IC4AL, TC4AL (10LM) RECESSED HOUSING



## SQUARE TRIMS

### PRODUCT DESCRIPTION

Patent pending dedicated LED, Air-Loc® sealed new construction housing with integral internally adjustable light engine • Double wall, shallow housing construction • IC4AL series can be completely covered with insulation and installs in 2 x 6 construction • TC4AL series for use in non-insulated areas (If installed where insulation is present, the insulation must be pulled back 3" from all sides of the TC housing) • Fully sealed housing stops infiltration and exfiltration of air, reducing heating and cooling costs without the use of additional gaskets • LED housing is designed to provide 50,000 hours of life • 5 year limited warranty on LED components.

### ENVIRONMENTALLY FRIENDLY, ENERGY EFFICIENT

- No harmful ultraviolet or infrared wavelengths
- No lead or mercury, RoHS compliant
- Comparable light output to 75W incandescent

### PRODUCT SPECIFICATIONS

**LED Light Engine** LED array attached to cast aluminum sliding heatsink integrated directly with housing provides superior heat transfer to ensure long life of the LED • Replaceable light engine mounts directly to inner housing assembly and incorporates the latest generation, high lumen output LED array • LEDs are binned within a 3-step MacAdam Ellipse exceeding ENERGY STAR® requirements for superior fixture to fixture color uniformity • 2700K, 3000K, 3500K, or 4000K color temperatures available • 90 CRI minimum.

**Optics** Three field interchangeable, TIR optics available in 18°, 30° and 40° beam angles • Module can accommodate one 2-inch diameter beam control lens or filter • Adjustable light engine module provides up to 35° vertical adjustment and 360° rotation.

**Aesthetic Trim Selections** Die cast aluminum square angle cut downlight, downlight only and lensed trim options • Downlights feature black insert to minimize glare at the aperture • Lensed trim 41LSQ is wet location approved for covered ceiling applications.

**LED Driver** Choice of dedicated 120 volt (120) driver or universal voltage driver (MVOLT) that accommodates input voltages from 120-277 volts AC at 50/60Hz • Power factor > 0.9 at 120V input • 120 volt only driver is dimmable with the use of most incandescent, magnetic low voltage and electronic low voltage wall box dimmers • Universal voltage driver is dimmable with the use of most 0-10V wall box dimmers • For a list of compatible dimmers, see [JUNOICLED-DIM](#).

**Life** Rated for 50,000 hours at 70% lumen maintenance.

**Labels** IC4AL is ENERGY STAR® certified • IC4AL is certified to the high efficacy requirements of California T24 JA8-2016 • UL listed for U.S. and Canada for through-branch wiring, damp locations (41LSQ listed for wet locations, covered ceilings) • Union made • UL and cUL.

**Testing** All reports are based on published industry procedures; field performance may differ from laboratory performance.

Specifications subject to change without notice.

### HOUSING FEATURES

**Housing** IC4AL designed for use in IC (insulated ceiling) or non-IC construction • TC4AL designed for use in non-IC construction • Aluminum housing sealed for Air-Loc® compliance • Housing is vertically adjustable to accommodate up to a 1 1/2" ceiling thickness.

**Junction Box** Pre-wired junction box provided with (6) 1/2" and (1) 3/4" knockouts, (4) knockouts for 12/2 or 14/2 NM cable and ground wire • UL listed and cUL listed for through-branch wiring, maximum 4 #12 branch circuit conductors • Junction box provided with removable access plates • Knockouts equipped with pryout slots • Quick connect electrical connectors supplied as standard for fast, secure installation.

**Mounting Frame** 22-gauge die-formed galvanized steel mounting frame • Rough-in section (junction box, mounting frame, housing and bar hangers) fully assembled for ease of installation.

**Real Nail 3 Bar Hangers** Patented (US Patent D552,969) Real Nail® 3 bar hangers: telescoping system permits quick placement of housing anywhere within 24" O.C. joists or suspended ceilings • Includes removable nail for repositioning of fixture in wood joist construction • Integral T-bar notch and clip for suspended ceilings.



### DIMENSIONS

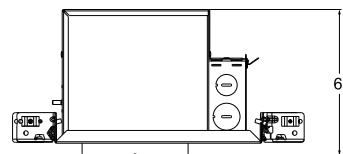
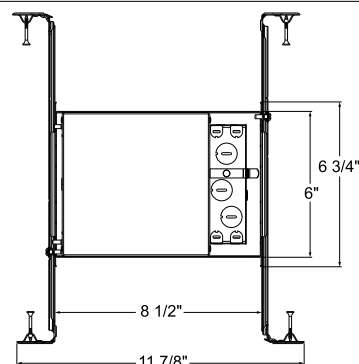

4 1/2" CEILING CUTOUT

### ELECTRICAL DATA

#### Dedicated 120V Only Driver Option (120) 120V

Input Power	16.4W (+/-5%)	
Input Current	0.15A	
Frequency	50/60Hz	
EMI/RFI	FCC Title 47 CFR, Part 15, Class B (Residential)	
Minimum starting temp	-25°C (-13°F)	

#### Universal Voltage Driver (MVOLT ZT)

	120V	277V
Input Power	16.0W (+/-5%)	16.0W (+/-5%)
Input Current	0.15A	0.06A
Frequency	50/60Hz	50/60Hz
EMI/RFI	FCC Title 47 CFR, Part 15, Class A (Commercial)	FCC Title 47 CFR, Part 15, Class A (Commercial)
Minimum starting temp	-20°C (-4°F)	-20°C (-4°F)

#### Lutron Hi-Lume® LED Driver (MVOLT ECOS3)

	120V	277V
Input Power	16.4W (+/-5%)	16.6W (+/-5%)
Input Current	0.15A	0.07A
Frequency	50/60Hz	50/60Hz
EMI/RFI	FCC Title 47 CFR, Part 15, Class A (Commercial)	FCC Title 47 CFR, Part 15, Class A (Commercial)
Minimum starting temp	0°C (32°F)	0°C (32°F)

# 4" IC AND TC 1000 LUMEN INTERNALLY ADJUSTABLE LED DOWNLIGHT NEW CONSTRUCTION

IC4AL, TC4AL (10LM) RECESSED HOUSING  
SQUARE TRIMS

**ORDERING INFORMATION** Housing and trim can be ordered together or separate, but will always ship separately.

Example: IC4AL 10LM 27K 90CRI FL 120 FRPC

Series	Lumens	Color Temperature	CRI	Distribution	Voltage	Driver
IC4AL 4" LED Internally Adjustable New Const. IC Downlight	10LM 1000 Nominal Lumens	27K 2700K	90CRI 90+ CRI	FL Flood	120 120V	FRPC Forward/Reverse Phase Cut
		30K 3000K		NFL Narrow Flood	MVOLT Multi-Volt (120-277V)	ZT 0 - 10V Dimming Driver
		35K 3500K		SP Spot		
		40K 4000K				

Notes: 120 must be ordered with FRPC. MVOLT must be ordered with ZT

Example: TC4AL 10LM 27K 90CRI FL MVOLT ECOS3

Series	Lumens	Color Temperature	CRI	Distribution	Voltage	Driver
TC4AL 4" LED Internally Adjustable New Const. Non IC Downlight	10LM 1000 Nominal Lumens	27K 2700K	90CRI 90+ CRI	FL Flood	MVOLT Multi-Volt	ECOS3 Lumen Hi - Lume A Series, 3-wire fluorescent controls & Lutron Ecosystem
		30K 3000K		NFL Narrow Flood		
		35K 3500K		SP Spot		
		40K 4000K				

TC4AL is not ENERGY STAR® or T24 compliant

## Trim/Description



- 47LSQ BWH** 4" Square Adjustable Angle Cut Reflector Trim - Black, White Trim Ring  
**47LSQ HZWH** 4" Square Adjustable Angle Cut Reflector Trim - Haze, White Trim Ring  
**47LSQ WHZWH** 4" Square Adjustable Angle Cut Reflector Trim - Wheat Haze, White Trim Ring  
**47LSQ WWH** 4" Square Adjustable Angle Cut Reflector Trim - White, White Trim Ring

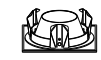

- 42LSQ BWH** 4" Square Downlight Reflector Trim - Black, White Trim Ring  
**42LSQ HZWH** 4" Square Downlight Reflector Trim - Haze, White Trim Ring  
**42LSQ WHZWH** 4" Square Downlight Reflector Trim - Wheat Haze, White Trim Ring  
**42LSQ WWH** 4" Square Downlight Reflector Trim - White, White Trim Ring



- 41LSQ WH\*** 4" Square Adjustable Lens Shower Trim - White Trim Ring



Trim Size: 5" O.D.

Note: In Canada when insulation is present, Type IC fixtures must be used.

\*Wet Location

## Accessories (ordered separately)

Catalog Number	Description
<b>CGF 200 MPINK</b>	Color Glass Filter - 2" Diameter - Medium Pink
<b>CGF 200 WRED</b>	Color Glass Filter - 2" Diameter - Warm Red
<b>CGF 200 DLTBLUE</b>	Color Glass Filter - 2" Diameter - Daylight Blue
<b>CGF 200 MBLU</b>	Color Glass Filter - 2" Diameter - Medium Blue
<b>CGF 200 MAMB</b>	Color Glass Filter - 2" Diameter - Medium Amber
<b>CGF 200 MGRN</b>	Color Glass Filter - 2" Diameter - Medium Green
<b>DGF 200 DRED</b>	Dichroic Glass Filter - 2" Diameter Red
<b>DGF 200 MGRN</b>	Dichroic Glass Filter - 2" Diameter Medium Green
<b>DGF 200 MBLU</b>	Dichroic Glass Filter - 2" Diameter Medium Blue
<b>DGF 200 DYEL</b>	Dichroic Glass Filter - 2" Diameter Yellow (Dichroic)
<b>DGF 200 MAGEN</b>	Dichroic Glass Filter - 2" Diameter Magenta
<b>DGF 200 CYAN</b>	Dichroic Glass Filter - 2" Diameter Cyan
<b>DCCF 200 HL4250</b>	Dichroic Color Correction Filter - 2" Diameter - Halogen - to - Daylight
<b>DIFF 200</b>	Diffusion Glass Lens - 2" Diameter
<b>UVF 200</b>	UV Filter Lens - 2" Diameter
<b>HCLBL 200</b>	Hexagonal Cell Louver - Black - 2" Diameter
<b>LSPREAD 200</b>	Linear Spread Glass Lens - 2" Diameter
<b>PRISM 200</b>	Prismatic Glass Lens - 2" Diameter
<b>TIR2 SPT</b>	TIR Optic - Spot
<b>TIR2 NFLD</b>	TIR Optic - Narrow Flood
<b>TIR2 FLD</b>	TIR Optic - Flood

# 4" IC AND TC 1000 LUMEN INTERNALLY ADJUSTABLE LED DOWNLIGHT NEW CONSTRUCTION

## IC4AL, TC4AL (10LM) RECESSED HOUSING SQUARE TRIMS

### PHOTOMETRICS

#### PHOTOMETRIC REPORT

Test Report#: PTO9152802R  
Catalog No: IC4AL 10LM 35K 90CRI SP 120  
FRPC with 42LSQ HZWH, Downlight Cone Haze  
Finish Square Trim and Spot Optic  
Luminaire Spacing Criteria: 0.30  
Luminaire LPW: 56

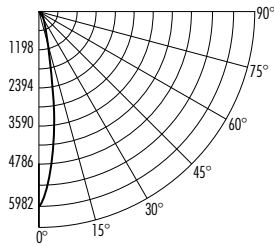

#### CANDLEPOWER DISTRIBUTION (Candelas)

Degrees Vertical	0°
0	5982
5	4561
15	1241
25	221
35	31
45	4
55	0
65	0
75	0
85	0
90	0

Multipliers:  
27K - 0.93 35K - 1.00  
30K - 0.96 40K - 1.03

#### AVERAGE INITIAL FOOTCANDLES

Multiple Units (Square Array, 60'x60' room)  
Ceiling 80%, Wall 50%, Floor 20%

Spacing	RCR1	RCR3	RCR5
4.0'	64	59	55
5.0'	41	38	35
6.0'	29	26	24
7.0'	23	21	20
8.0'	18	17	16
9.0'	14	13	12
10.0'	10	9	9

#### ZONAL LUMEN SUMMARY

Zone	Lumens	%Lamp	%Fixture
0-30°	875	N/A	96.0
0-40°	905	N/A	99.4
0-60°	911	N/A	100.0
0-90°	911	N/A	100.0

#### INITIAL FOOTCANDLES

(One Unit, 16.4W, 17.0° Beam)

Distance to Illuminated Plane (Feet)	Footcandles Beam Center	Beam Diameter
4	373.9	1.2
6	166.2	1.8
8	93.5	2.4
10	59.8	3.0

#### LUMINANCE (Average cd/m²)

Degrees	Average 0° Luminance
45	850
55	0
65	0
75	0
85	0

#### PHOTOMETRIC REPORT

Test Report#: PTO9152804R  
Catalog No: IC4AL 10LM 35K 90CRI NFL 120  
FRPC with 42LSQ HZWH, Downlight Cone Haze  
Finish Square Trim and Narrow Flood Optic  
Luminaire Spacing Criteria: 0.48  
Luminaire LPW: 53

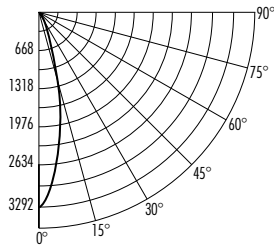

#### CANDLEPOWER DISTRIBUTION (Candelas)

Degrees Vertical	0°
0	3292
5	3101
15	1467
25	213
35	58
45	6
55	0
65	0
75	0
85	0
90	0

Multipliers:  
27K - 0.93 35K - 1.00  
30K - 0.96 40K - 1.03

#### AVERAGE INITIAL FOOTCANDLES

Multiple Units (Square Array, 60'x60' room)  
Ceiling 80%, Wall 50%, Floor 20%

Spacing	RCR1	RCR3	RCR5
4.0'	61	56	51
5.0'	39	36	33
6.0'	27	25	23
7.0'	22	20	19
8.0'	17	16	15
9.0'	13	12	11
10.0'	10	9	8

#### ZONAL LUMEN SUMMARY

Zone	Lumens	%Lamp	%Fixture
0-30°	813	N/A	93.8
0-40°	858	N/A	98.9
0-60°	867	N/A	100.0
0-90°	867	N/A	100.0

#### INITIAL FOOTCANDLES

(One Unit, 16.4W, 27.7° Beam)

Distance to Illuminated Plane (Feet)	Footcandles Beam Center	Beam Diameter
4	205.8	2.0
6	91.4	3.0
8	51.4	3.9
10	32.9	4.9

#### LUMINANCE (Average cd/m²)

Degrees	Average 0° Luminance
45	1264
55	0
65	0
75	0
85	0

#### PHOTOMETRIC REPORT

Test Report#: PTO9152806R  
Catalog No: IC4AL 10LM 35K 90CRI FL 120  
FRPC with 42LSQ HZWH, Downlight Cone Haze  
Finish Square Trim and Flood Optic  
Luminaire Spacing Criteria: 0.60  
Luminaire LPW: 61

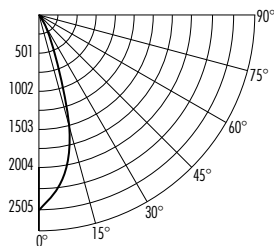

#### CANDLEPOWER DISTRIBUTION (Candelas)

Degrees Vertical	0°
0	2505
5	2408
15	1597
25	498
35	106
45	9
55	0
65	0
75	0
85	0
90	0

Multipliers:  
27K - 0.93 35K - 1.00  
30K - 0.96 40K - 1.03

#### AVERAGE INITIAL FOOTCANDLES

Multiple Units (Square Array, 60'x60' room)  
Ceiling 80%, Wall 50%, Floor 20%

Spacing	RCR1	RCR3	RCR5
4.0'	70	63	57
5.0'	45	40	36
6.0'	31	28	25
7.0'	25	23	20
8.0'	20	18	16
9.0'	15	14	12
10.0'	11	10	9

#### ZONAL LUMEN SUMMARY

Zone	Lumens	%Lamp	%Fixture
0-30°	906	N/A	90.6
0-40°	986	N/A	98.6
0-60°	1000	N/A	100.0
0-90°	1000	N/A	100.0

#### INITIAL FOOTCANDLES

(One Unit, 16.4W, 34.7° Beam)

Distance to Illuminated Plane (Feet)	Footcandles Beam Center	Beam Diameter
4	156.6	2.5
6	69.6	3.7
8	39.1	5.0
10	25.1	6.2

#### LUMINANCE (Average cd/m²)

Degrees	Average 0° Luminance
45	1853
55	0
65	0
75	0
85	0

Fixtures tested to IES recommended standard for solid state lighting per LM-79-08. Photometric performance on a single unit represents a baseline of performance for the fixture. Results may vary in the field.

# 4" IC AND TC 1000 LUMEN INTERNALLY ADJUSTABLE LED DOWNLIGHT NEW CONSTRUCTION

IC4AL, TC4AL (10LM) RECESSED HOUSING  
**SQUARE TRIMS**

**PHOTOMETRICS**

**PHOTOMETRIC REPORT**  
Test Report: PT09153002R  
Catalog No: IC4AL 10LM 35K 90CRI  
SP 120 FRPC with 47LSQ HZWH and Spot Optic  
Watts: 16.4  
Lumens: 983  
Luminaire LPW: 60

Candlepower Distribution (Candelas)	
Degrees Vertical	Candela
0°	85
5°	164
10°	365
15°	709
20°	1229
25°	2351
30°	4494
35°	6059
40°	4676
45°	2416
50°	1133
55°	370
60°	96
65°	32
70°	14
75°	4
80°	0
85°	0
90°	0

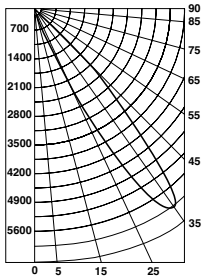

**PHOTOMETRIC REPORT**  
Test Report: PT09152922R  
Catalog No: IC4AL 10LM 35K 90CRI  
NFL 120 FRPC with 47LSQ HZWH and Narrow Flood Optic  
Watts: 16.4  
Lumens: 990  
Luminaire LPW: 60

Candlepower Distribution (Candelas)	
Degrees Vertical	Candela
0°	85
5°	145
10°	280
15°	655
20°	1510
25°	2571
30°	3241
35°	3465
40°	3231
45°	2596
50°	1642
55°	604
60°	143
65°	73
70°	32
75°	8
80°	0
85°	0
90°	0

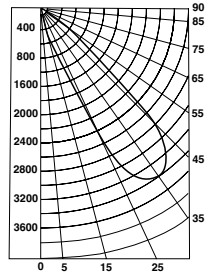

**PHOTOMETRIC REPORT**  
Test Report: PT09152902R  
Catalog No: IC4AL 10LM 35K 90CRI  
FL 120 FRPC with 47LSQ HZWH and Flood Optic  
Watts: 16.4  
Lumens: 1050  
Luminaire LPW: 64

Candlepower Distribution (Candelas)	
Degrees Vertical	Candela
0°	159
5°	321
10°	628
15°	1072
20°	1621
25°	2129
30°	2452
35°	2537
40°	2356
45°	1970
50°	1406
55°	729
60°	378
65°	188
70°	72
75°	12
80°	0
85°	0
90°	0

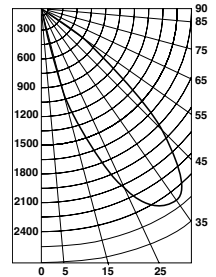

**CBCP** - Centerbeam candlepower  
**FC** - Footcandles at beam center (aim point)

In vertical aiming applications, aim point (X) is determined by dividing distance from the wall (D) by the tangent of the desired aim angle (A) (0.5774 for 30°, 1.0 for 45°).

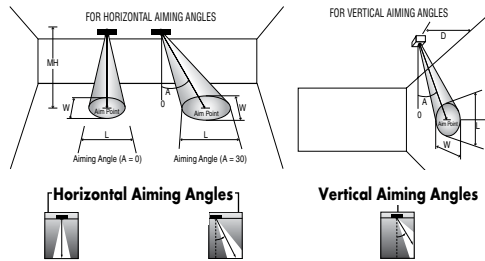

FIXTURE	Beam Type	Beam Spread°	CBCP	0°			30°			30°					
				MH	FC	L	W	FC	L	W	D	FC	X	L	W
IC4AL (10LM) LED, 3500K Spot	SP	18°	6059	4	379	1.3	1.3	246	1.7	1.5	2	189	3.5	2.7	1.3
				6	168	1.9	1.9	109	2.6	2.2	3	84	5.2	4.1	1.9
				8	95	2.5	2.5	61	3.4	2.9	4	47	6.9	5.5	2.5
				10	61	3.2	3.2	39	4.3	3.7	5	30	8.7	6.9	3.2
IC4AL (10LM) LED, 3500K Narrow Flood	NFL	30°	3465	4	217	2.1	2.1	141	2.9	2.5	2	108	3.5	5.5	2.1
				6	96	3.2	3.2	63	4.4	3.7	3	48	5.2	8.2	3.2
				8	54	4.3	4.3	35	5.9	5.0	4	27	6.9	10.9	4.3
				10	35	5.4	5.4	23	7.3	6.2	5	17	8.7	13.7	5.4
IC4AL (10LM) LED, 3500K Flood	FL	40°	2537	4	159	2.9	2.9	103	4.1	3.4	2	79	3.5	9.7	2.9
				6	70	4.4	4.4	46	6.1	5.0	3	35	5.2	14.5	4.4
				8	40	5.8	5.8	26	8.1	6.7	4	20	6.9	19.3	5.8
				10	25	7.3	7.3	16	10.2	8.4	5	13	8.7	24.2	7.3
				12	18	8.7	8.7	11	12.2	10.1	6	9	10.4	29.0	8.7

Multipliers: 27K - 0.93  
30K - 0.96  
35K - 1.00  
40K - 1.03