

Technical Information Bulletin

LED Downlight Accessories



Date: _____ Name of distributor: _____
 In hands date of project: _____ Client #: _____
 Project name/Number: _____ Name of end user: _____

ORDERING INFORMATION

Order code: 66819
Description: ACC/MPLATE/2.75IN/HANG.BARS/STD
UPC: 69549668195
Case quantity: 25



SPECIFICATIONS

Type: Mounting Plate with Hanger Bars
Material: Steel
Length: 8 1/4" (210 mm)
Width: 6 5/16" (160 mm)
Height: 9 13/16" (250 mm)
Opening diameter: 2 3/4" (70 mm)

TECHNICAL DRAWING

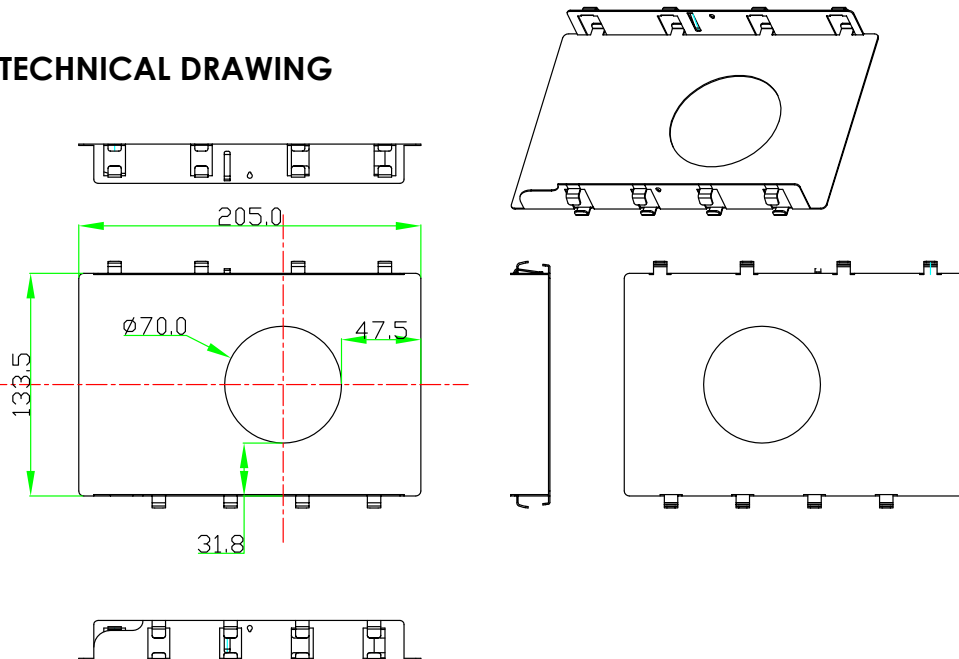

Qty	Description	Price

I accept the specifications of the luminaire configuration mentioned above.

Name: _____
 Company: _____
 Signature: _____

Date: _____