

Maestro RF 0–10 V Sensor Dimmer/ RF Sensor Switch

Lutron Maestro RF 0–10 V Sensor Dimmer/RF Sensor Switches are lighting controls with passive infrared sensors that automatically control the lights in an area. These sensors detect heat from occupants moving within an area to determine when the space is occupied.

Features Lutron Clear Connect RF technology, which enables wireless communication with Radio Powr Savr sensors, and Pico remote controls for light control and general switched loads.

These products are also compatible with the Vive hub which enables a simple setup process using a standard web browser on any Wi-Fi enabled phone, tablet or computer. It also enables control and monitoring of all Vive devices. The Vive hub can be added at any time, however system reprogramming will be required. For a complete list of features supported with the Vive hub, see specification submittal 369902 at www.lutron.com

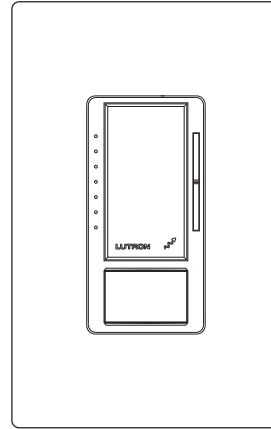

Dimmer

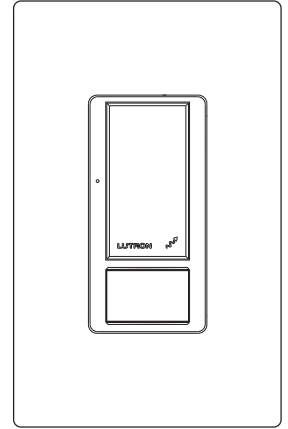

Switch

Features

- Controls 0–10 V_{AC} electronic fluorescent ballasts or LED driver load types¹
- Passive infrared motion detection with exclusive Lutron XCT Technology for fine motion detection
- 180° sensor field-of-view
- Up to 30 ft × 30 ft (9 m × 9 m) [900 ft² (81 m²)] major motion coverage and 20 ft × 20 ft (6 m × 6 m) [400 ft² (36 m²)] minor motion coverage
- Occupancy version can be set to auto-on/auto-off or manual-on/auto-off
- Adjustable timeout (1, 5, 15, or 30 minutes)
- Adjustable settings for auto-on light level (occupied level): Fully adjustable from 1%–100%
- Adjustable settings for auto-off light level (occupied level): Fully adjustable from 0%–100%
- Adjustable sensitivity level: High, Med, Low, Min
- Off warning fades lights to off over a period of 10 seconds¹
- Adaptive switching algorithm for extended relay life
- Smart ambient light detection (ALD)
- Works with up to 10 Pico remote controls, 1 daylight, and 10 Radio Powr Savr PIR sensors
- High-end trim and low-end trim to adjust maximum and minimum light levels

¹ Only available with the sensor dimmer. Not available with the sensor switch.

<p>Job Name:</p> <p>Job Number:</p>	<p>Model Numbers:</p>
--	------------------------------

Models Available

Model Number	Description	Sensor Operation	Load Types
MRF2S-8SD010-XX ¹	Occupancy/vacancy single-pole/multi-location sensor dimmer	Auto-On/Auto-Off or Manual-On/Auto-Off	For use with permanently installed electronic fluorescent ballast or LED driver lighting loads
MRF2S-8SS-XX ¹	Occupancy/vacancy single-pole/multi-location sensor switch	Auto-On/Auto-Off or Manual-On/Auto-Off	For use with all lighting loads
MRF2S-8SDV010-XX ¹	Vacancy single-pole/multi-location sensor dimmer	Manual-On/Auto-Off	For use with permanently installed electronic fluorescent ballast or LED driver lighting loads
MRF2S-8SSV-XX ¹	Vacancy single-pole/multi-location sensor switch	Manual-On/Auto-Off	For use with all lighting loads

¹ XX in model number represents color/finish code. See **Colors and Finishes** on page 10.

Notes:

- Neutral is required for product to function. If a neutral wire is not present, consult a licensed electrician.
- When power is applied, the sensor dimmer/switch can be manually turned on or off after the first 10 seconds and will automatically control the load after 2 minutes.
- The sensor dimmer works with all ballasts and drivers that provide a current source compliant to IEC 60929 Annex E.2.
- The 0–10 V_{AC} control wires are not to exceed 250 ft (76.2 m) in length, and must have a size of no less than 20 AWG (0.75 mm²).
- The 0–10 V_{AC} wires may be installed as Class 1 or Class 2 per NEC® or local jurisdiction.
- Do not install dimmers/switches to control receptacles or motor-operated appliances.

Job Name:	Model Numbers:
Job Number:	

Specifications

Regulatory Approvals

- UL® Listed to U.S. and Canadian safety requirements
- Complies with Title 20 and Title 24 Section 110.9

Power

- Operating voltage: 120/277 V~ 50/60 Hz, 8 A (USA), 120 V~ 50/60 Hz, 8 A (Canada) of 0–10 V== electronic fluorescent ballasts or LED drivers for sensor dimmer, and all lighting loads for sensor switch

Loads

- **Sensor Dimmer**
 - Works with all ballasts and drivers that provide a current source compliant to IEC 60929 Annex E.2, and whose inrush current does not exceed NEMA 410 standards for electronic ballast/driver loads of 8 A steady state current
 - Supports Electronic Off functionality for voltages less than 0.5 V
 - 50 mA max sink current
 - Controls up to 25 ballasts or drivers (IEC 60929 Annex E.2 requires the ballast/driver to limit the current to 2.0 mA maximum)
 - No minimum load
- **Sensor Switch**
 - Works with all lighting loads

Environment

- Ambient operating temperature: 32 °F to 104 °F (0 °C to 40 °C), 0%–90% humidity, non-condensing; indoor use only

Warranty

- 5 Year Limited Warranty
For additional Warranty information, please visit:
www.lutron.com/TechnicalDocumentLibrary/Sensor_Warranty.pdf

Key Design Features

Dimmer

- On a single-tap, lights fade On or Off to previous level
- On a double-tap, lights go to full On
- Light levels can be fine-tuned by pressing and holding the dimming rocker until the desired light level is reached
- High-end trim (adjust maximum light level that can be achieved, for energy savings)
- Low-end trim (adjust minimum light level that can be dimmed down, to prevent flickering lights)

Vive System Communications and Capacity

- Maestro Wireless controls communicate with the Pico remote controls and Radio Powr Savr sensors through radio frequency (RF).
- Receives wireless inputs from up to 10 Pico remote controls, 10 Radio Powr Savr occupancy/vacancy sensors, and 1 Radio Powr Savr daylight sensor.
- Maestro Wireless local controls must be located within 60 ft (18 m) line-of-sight or 30 ft (9 m) through walls, of Radio Powr Savr sensors and Pico remote controls. The 60 ft (18 m) range is not reduced by a ceiling tile obstruction.

Additional Information on Sensors

- For more information, please see www.lutron.com/occvacsensors
- Lutron Customer Assistance: 1.844.LUTRON1

Job Name: Job Number:	Model Numbers:
--	-----------------------

Custom Settings (default settings shown in **bold**)

Note: This is how to program these settings in standalone applications (not part of the Vive system). For a complete list and description of available settings for standalone applications, refer to Application Note #687 (048687) at www.lutron.com. For set-up, programming, and troubleshooting with a Vive system, please refer to the installation instructions included with the Vive hub or at www.lutron.com.

Timeout

- 30 min
- **15 min**
- 5 min
- 1 min

Mode: Sensor Modes¹

Lights automatically turn off in all sensor modes

- **Occ: Occupancy mode (Auto-On/ Auto-Off)**
- Lrn: Occupancy with learning ALD mode
- Fixd: Occupancy with fixed ALD mode
- Vac: Vacancy mode (Manual-On/ Auto-Off)

PIR: Passive Infrared Sensitivity

- **High**
- Med
- Low
- Min

Fixed ALD Light Level^{2,3}

- High
- Med
- **Low⁴**
- Min

Walk-Thru Mode (MRF2S-8SD010 and MRF2S-8SS only)²

- Enabled
- **Disabled**

Occupied Level^{5,6}

A programmable setting that determines the light level the sensor dimmer will turn on to, once occupancy has been detected

Vacancy Light Level⁶

The level to which the sensor dimmer dims or turns off when motion has not been detected for the timeout period

Electronic Off^{2,6,7}

- Enabled
- **Disabled**

Low-End Trim^{6,8}

- Fully adjustable from 1% to 45%

High-End Trim^{6,8}

- Fully adjustable from 55% to 100%

¹ Sensor Mode is locked as "Vacancy" in vacancy only models (MRF2S-8SDV010 and MRF2S-8SSV), in standalone applications. This restriction is removed in the Vive system.

² Setting not available once device is configured in the Vive system.

³ ALD is when the sensor determines how much ambient light is enough, based on a fixed level you select. If there is enough light, it will NOT turn the lights On.

⁴ Low is the default setting for any sensor that is set by the user to "Occupancy with fixed ALD mode".

⁵ Fully adjustable from 1% to 100% within the adjustable range of low-end and high-end trim.

⁶ Only available with the sensor dimmer. Not available with sensor switch.

⁷ When enabled, electronic off keeps the product relay closed and dims to the low-end the loads that support electronic off. When disabled, it uses the product relay to turn the load On and Off.

⁸ Setting is fully variable within each range.



Job Name:	Model Numbers:
Job Number:	

Placement and Operation

- The ability of the sensor dimmer/switch to detect motion requires line-of-sight of room occupants and must have an unobstructed view.
- Hot objects and moving air currents can affect the performance of the sensor dimmer/switch. For best performance, the sensor dimmer/switch should be mounted at least 4 ft (1.2 m) away from HVAC vents and light bulbs.
- The performance of the sensor dimmer/switch depends on a temperature differential between the ambient room temperature and that of room occupants. Warmer rooms may reduce the ability of the sensor dimmer/switch to detect occupants.

NEMA WD7 Test Grid Coverage

(High Sensitivity Setting)

-  Major motion coverage: 900 ft² (81 m²)
-  Minor motion coverage: 400 ft² (36 m²)

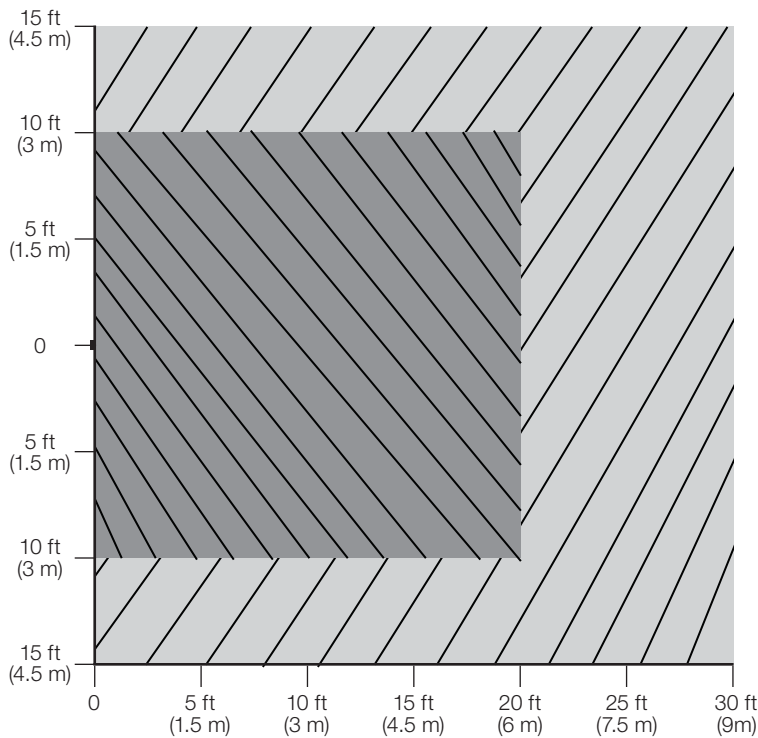

Horizontal Beam Diagram

(For Reference Only)

-  Beam 1
-  Beam 2

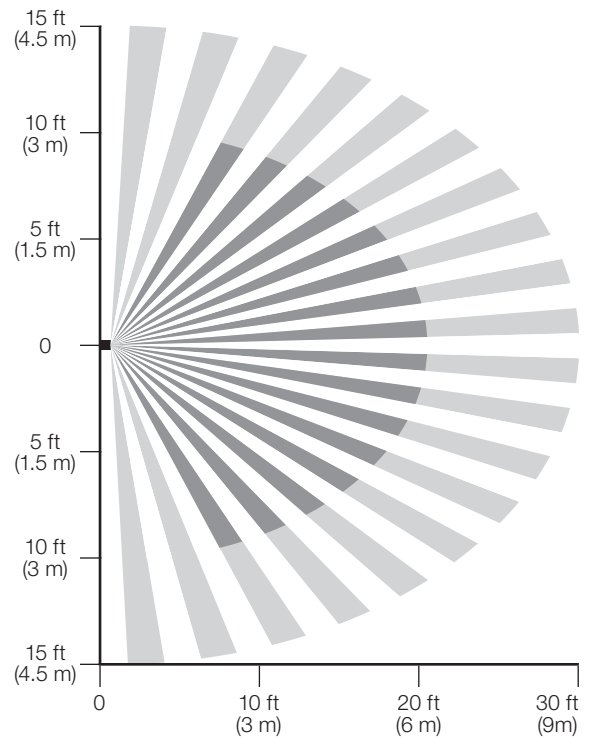

Vertical Beam Diagram

(For Reference Only)

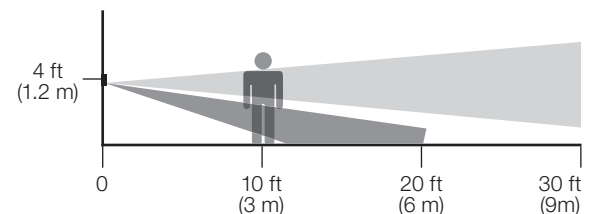

Job Name:	Model Numbers:
Job Number:	

Dimensions

Measurements shown as: in (mm)

Dimmer

Front View

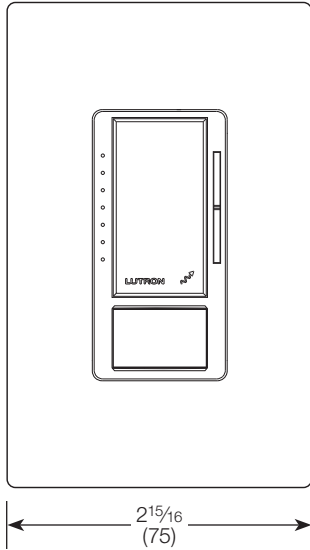

Side View

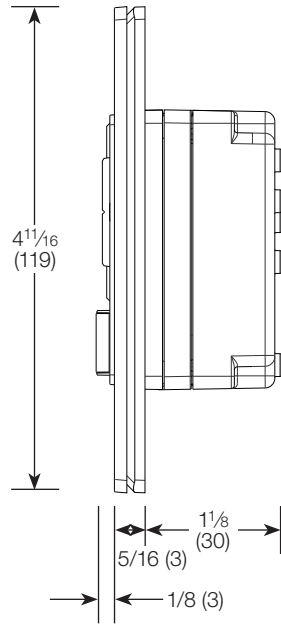

Operation

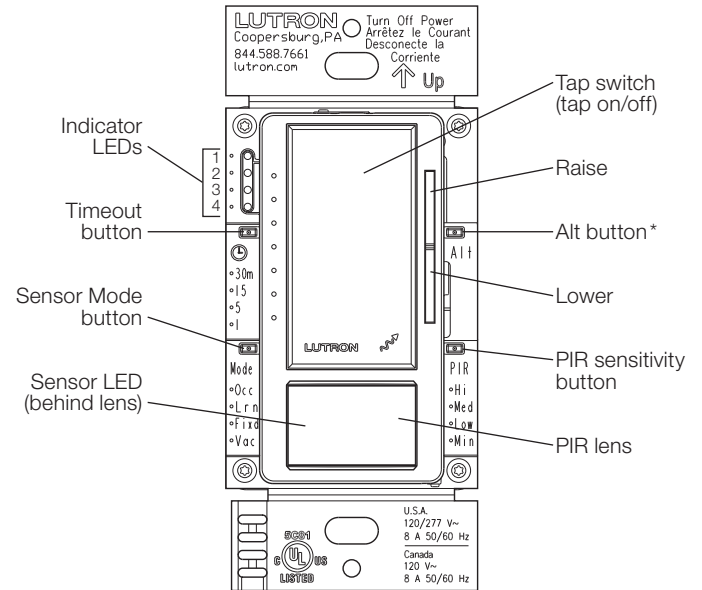

Switch

Front View

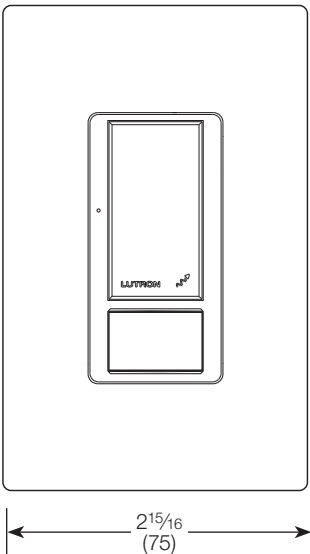

Side View

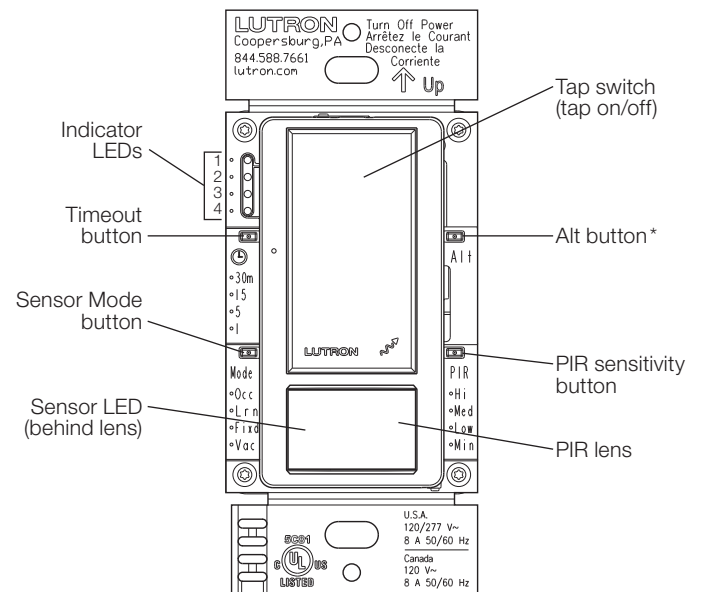
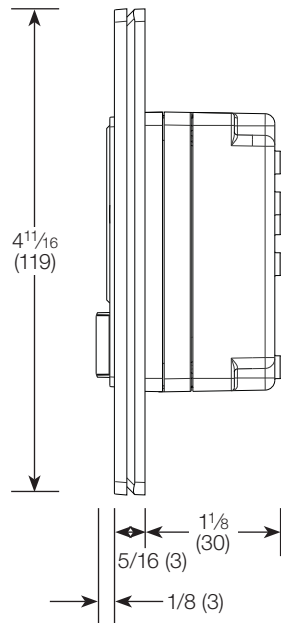

* Alt button is always used in conjunction with another button.

Job Name:	Model Numbers:
Job Number:	

Mounting*

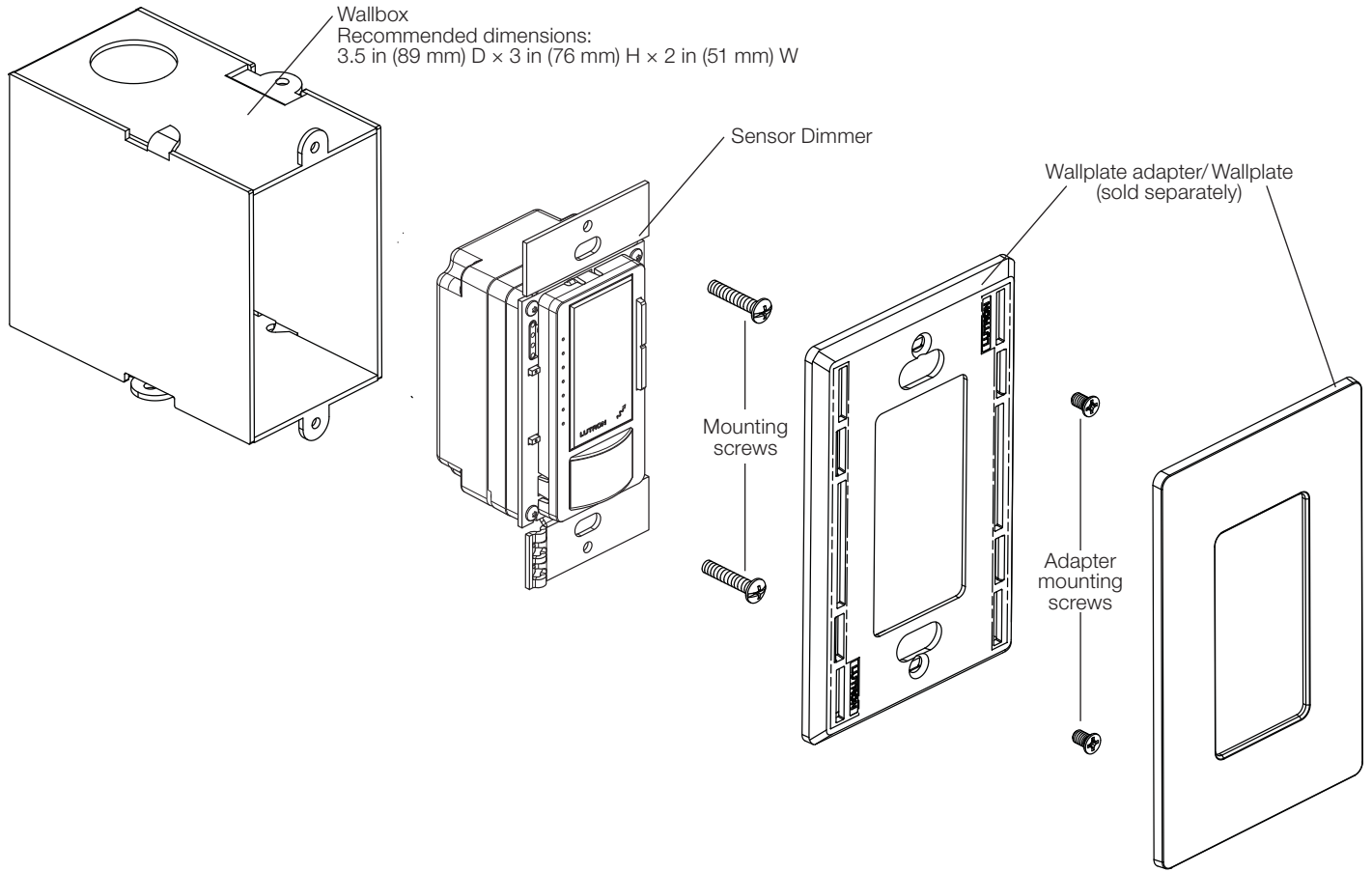

* Mounting is the same for the dimmer and the switch.

Job Name: Job Number:	Model Numbers:
------------------------------	----------------

Wiring Connections

In order to function all wires must be connected. Before installing wallplate, program all desired settings.

Dimmer

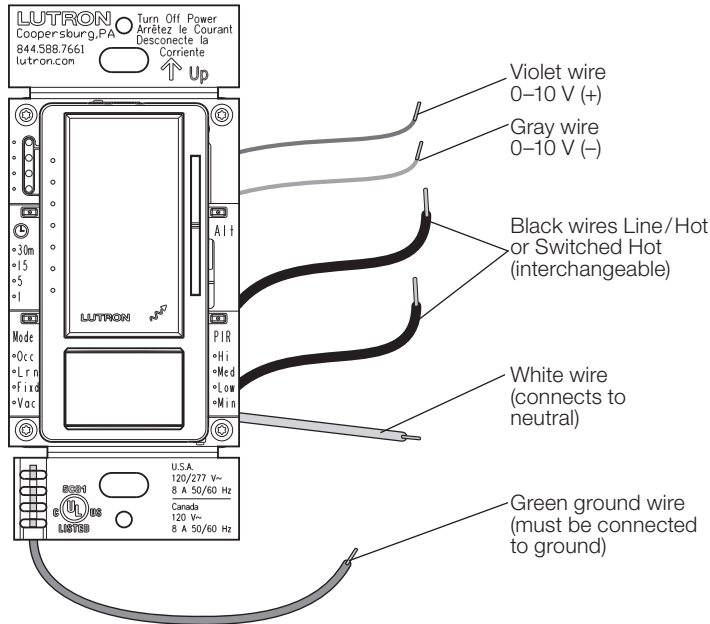

Switch

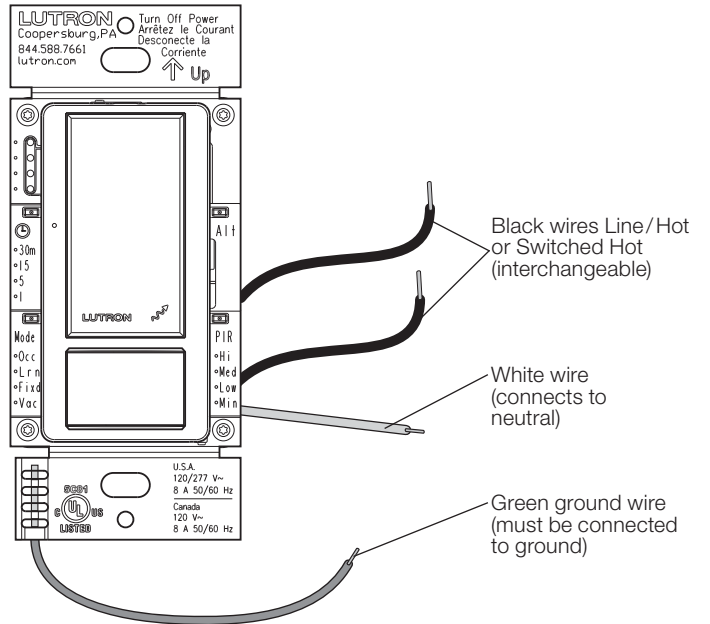

Job Name:	Model Numbers:
Job Number:	

Wiring: Single-Pole Dimmer Installation

With Neutral

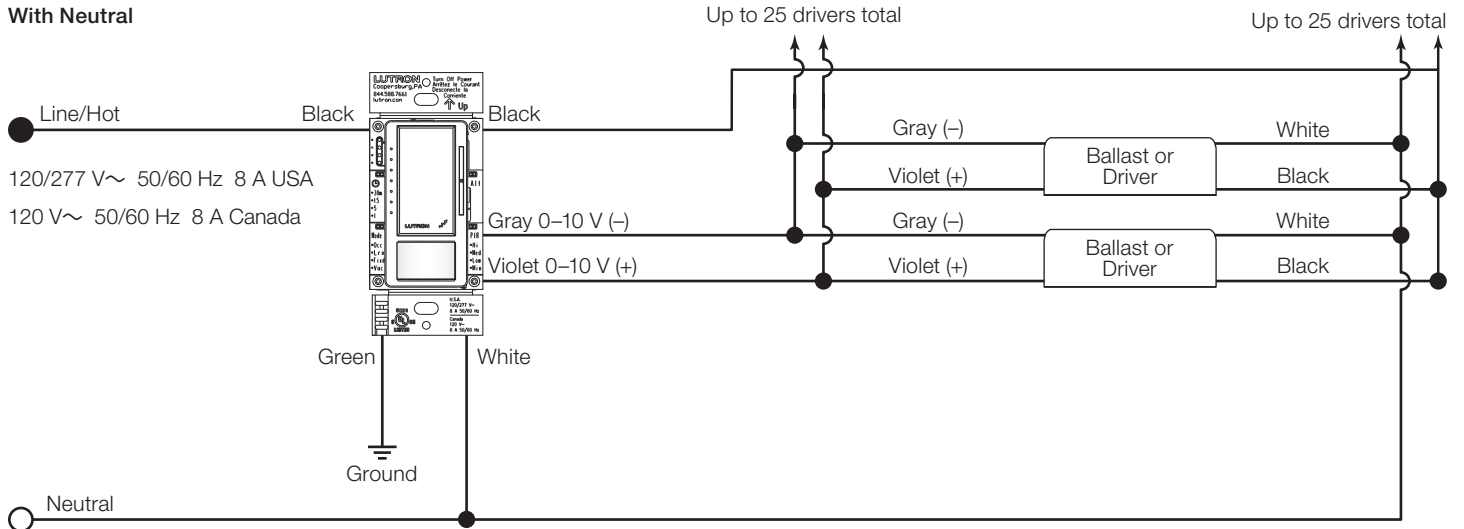

Wiring: Single-Pole Switch Installation

With Neutral

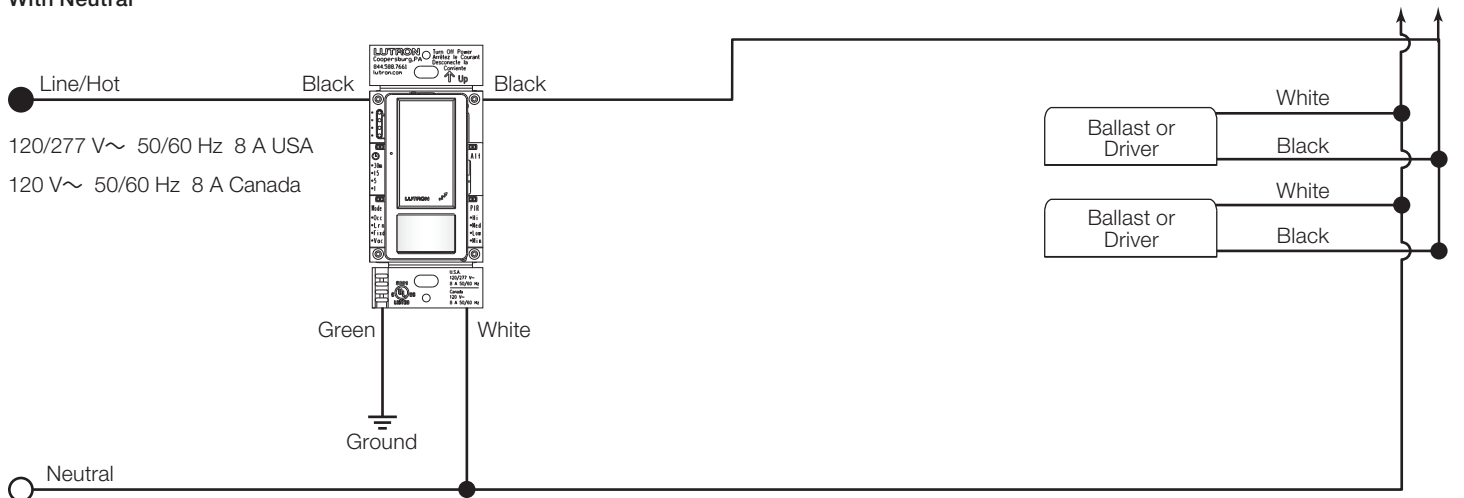

<p>Job Name:</p> <p>Job Number:</p>	<p>Model Numbers:</p>
-------------------------------------	-----------------------

Colors and Finishes

Gloss Finishes

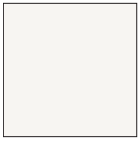

White
WH



Ivory
IV

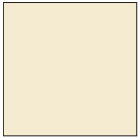

Almond
AL



Light Almond
LA

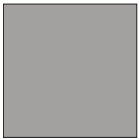

Gray
GR



Brown
BR



Black
BL

- Due to printing limitations, colors and finishes shown cannot be guaranteed to perfectly match actual product colors.
- Color chip keychains are available for more precise color matching:
 - Gloss Finishes: DG-CK-1

☼Lutron, Lutron, Maestro, Clear Connect, Vive, Pico, and C•L are trademarks of Lutron Electronics Co., Inc., registered in the U.S. and other countries. Radio Powr Savr and XCT are trademarks of Lutron Electronics Co., Inc.

UL is a trademark of UL LLC.

<p>Job Name:</p> <p>Job Number:</p>	<p>Model Numbers:</p>
--	------------------------------