

## 2-025

### Square Non-Insulated MR16

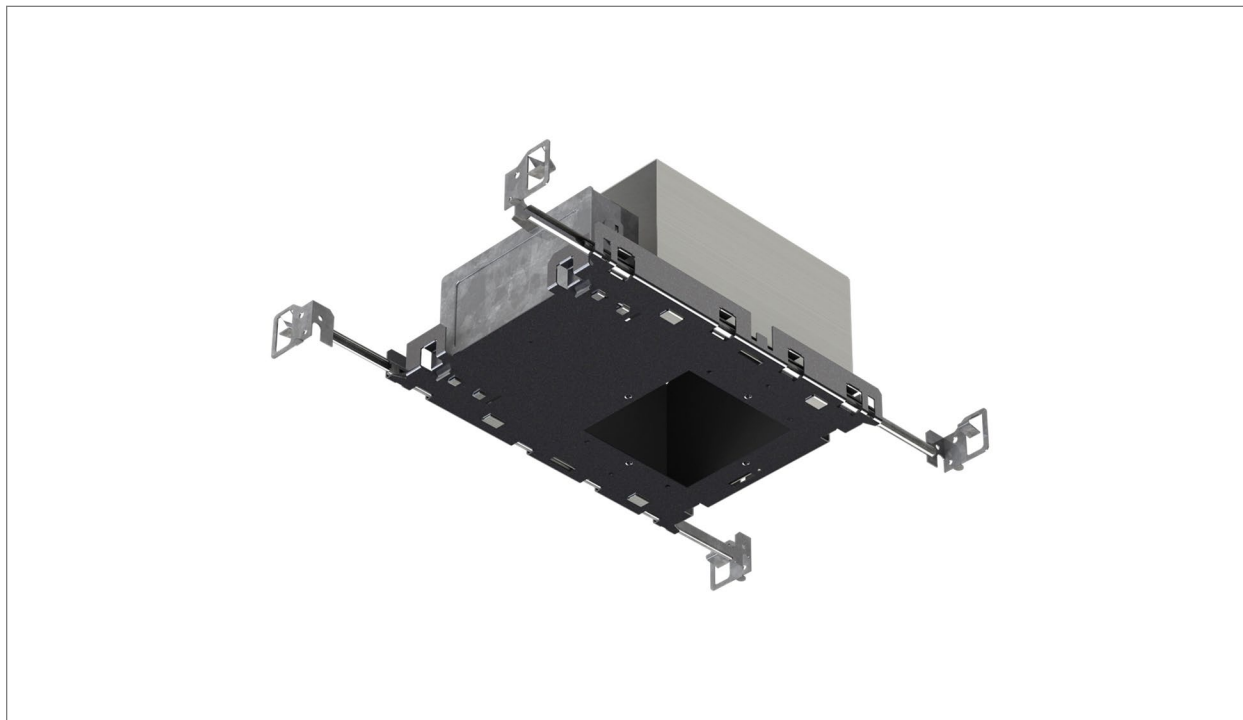

The 2-025 series housing is designed for non-insulated ceilings, allowing for installation of very shallow plenums, as low as 4". It's sleek footprint allows for compatibility with most ceiling applications.

#### FEATURES

- Rated for non-insulated ceilings
- Low voltage (12V) MR16 lamp (sold separately)
- Porcelain Bi Pin socket type GX5.3
- MR16 LED lamp is compatible with E15 electronic transformer option
- 16" hanger bars standard
- 20 Ga. cold rolled steel baseplate
- 18 Ga. galvanized steel junction box
- 5 junction box knock outs
- Approved for branch circuit wiring
- Transformer accessible through the ceiling









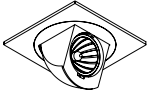
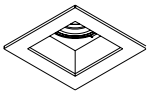
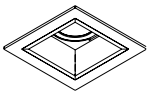

#### DETAILS

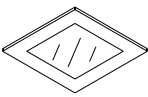
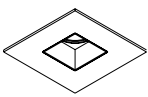
Aperture: 4"  
Shape: Square  
Ceiling: Non-Insulated

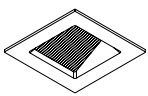
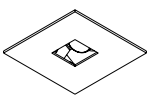

2-025-MR16-Specs • Subject to change without notice • Rev 2016.12.19 • 1/4

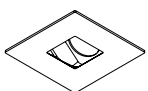
# Compatible Trims

Trim	Trim Type	
	Trimmed	Trimless
2-250 Quadra Split		—
2-500 Quadra		—
2-520 Miro		
2-550 Nemo		—
2-580 Forte		
2-582 Quadra Wall Wash		—
2-585 Quadra Pinhole		
2-587 Forte Wall Wash		
2-597 Quadra Linover		

# 2-025

## Square Non-Insulated MR16

---

Project

Type

Notes

Product Code

1 2 3 4 5

### 1. Housing

**2-025** Square

### 2. Housing Type

**F-Q** Non-Insulated

**F-Q-TL** Trimless Non-Insulated

### 3. Transformer

**E** Electronic

**E15** 15W Electronic <sup>1</sup>

**M** Magnetic

**MPT** Magnetic Potted <sup>2</sup>

### 4. Voltage

**120**

**277**

**347** <sup>3</sup>

### 5. Options

**BPHI** Black Painted Housing Interior

**WPHI** White Painted Housing Interior

### Notes

<sup>1</sup> **E15** transformer option is only compatible with Sora MR16 LED lamp.

<sup>2</sup> **MPT** transformer option is available in 120V and increases housing height to 4.5".

<sup>3</sup> **347** voltage is only available with **M** magnetic transformer.

---

2-025-MR16-Specs • Subject to change without notice • Rev 2016.12.19 • 4/4

---