

PLEASE CHECK WWW.MOLEX.COM FOR LATEST PART INFORMATION

Part Number: [1300130493](#)
Status: **Active**
Overview: Brad Mini-Change Connectors
Description: Mini-Change A-Size Receptacle, 5 Poles, 1/2" - 14 NPT Threads, Male (Straight) to 16 AWG Leads, 0.305m (1.0') Length

Documents:

[Drawing \(PDF\)](#) [RoHS Certificate of Compliance \(PDF\)](#)

Agency Certification

CSA LR6837
 UL E152210

General

Product Family Industrial Receptacles
 Series [130013](#)
 IP Rating IP67
 NEMA Rating NEMA 6
 Overview [Brad Mini-Change Connectors](#)
 Product Name Mini-Change
 Type Single Ended (pigtail)
 UPC 78172553228

Physical

Coupling Type External Thread
 Gender Male
 Keyway Single
 Length 0.305m
 Material - Component Zinc Die-Cast with Black Epoxy
 Mounting Thread Size 1/2" - 14 NPT
 Net Weight 63.502g
 Orientation Straight
 Panel Mount N/A
 Poles 5
 Temperature Range - Operating -20°C to +105°C
 Wire Size AWG 16
 Wire/Cable Type UL 1015

Electrical

Current - Maximum per Contact 8.0A
 Voltage - Maximum 600V AC/DC

Material Info

Engineering Number 1R5006A20A120

Reference - Drawing Numbers

Sales Drawing SD-130013-120-001

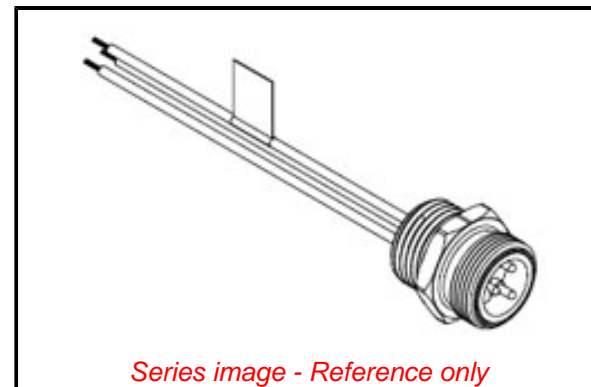

Series image - Reference only

EU ELV

Not Relevant

EU RoHS

Compliant with Exemption 6(c)

REACH SVHC

Contained Per - D(2020)4578-DC (25 June 2020)
 lead

Halogen-Free

Status

Not Low-Halogen

For more information, please visit [Contact US](#)

China ROHS

50 Image

ELV

Not Relevant

RoHS Phthalates

Not Contained

Search Parts in this Series

[130013 Series](#)