



Series Spec Sheet

LUMEINA

Small architectural LED downlight

Lumeina™ Series is the perfect combination of state of the art technology and aesthetic design. The quality of light of this series is comparable to an halogen lamp offering crisp, directional light which perfectly highlights surroundings. It offers a CRI of 90 and glare-control reflector design. Lumeina offers style, discretion and flexibility with a wide selection of interchangeable trims and accessories.

FEATURES AND SPECIFICATIONS

• Construction

Finition

- Powder loaded die-cast aluminium trim
- Available shapes and sizes Round and Square
- Clear glass lense

• Installation

- Torsion clips
- The module is intended for mounting in an indoor application only

• Technical specifications

- 90 CRI
- Glare-control reflector design
- The luminaire includes an LED module and an LED driver
- Suitable for dry location

- 6 W module only - Suitable for IC installation
- 9 W module only - Do not cover the module with insulation material
- Forward and reverse phase dimming
- Available color temperature: 2 700, 3 000, 3 500 and 4 000 K
- Estimated lifespan of 50 000 hours to L70
- Ambient temperature: -20°C to 45°C
- Air tight for shower trims only
- 22°, 36° and 60° beam angles

• Compliances

- ETL

5¹
warranty

3²
warranty

dimmable
fixture

dry
location

airtight

IP
65

ETL
US

¹ Applicable on modules

² Applicable on shower trim 64732 only

OVERVIEW

Light source	LED
Watts (W)	6, 9
Lumen output (lm/ft)	750, 950
Efficiency (lm/W)	106, 125
Color temperature (K)	2 700, 3 000, 3 500, 4 000
CRI	90+

QUICK SHIP TECHNICAL SPECIFICATION TABLE LED MODULES ☎️¹

Order code	Part number	Watts	Volt	Color temp.	Lumen	Efficiency	CRI	Life L70	Beam angle	CBCP	Power factor	THD	Traditionnal equivalent (W)	Case qty
		(W)	(VAC)	(K) ²	(lm) ³	(lm/W)	(hrs) ⁴	(°)	(cd)		(%)		(master)	
IC (can be used in insulated ceiling)														
66695	LUMEINA/MOD/IC/6W/27K/22/STD	6	120	2 700	750	125	90+	50 000	22	2 998	>0.9	<20	50	20
66696	LUMEINA/MOD/IC/6W/27K/36/STD	6	120	2 700	750	125	90+	50 000	36	1 731	>0.9	<20	50	20
66697	LUMEINA/MOD/IC/6W/27K/60/STD	6	120	2 700	750	125	90+	50 000	60	1 039	>0.9	<20	50	20
64706	LUMEINA/MOD/IC/6W/30K/22/STD	6	120	3 000	750	125	90+	50 000	22	3 051	>0.9	<20	50	20
64707	LUMEINA/MOD/IC/6W/30K/36/STD	6	120	3 000	750	125	90+	50 000	36	1 763	>0.9	<20	50	20
64708	LUMEINA/MOD/IC/6W/30K/60/STD	6	120	3 000	750	125	90+	50 000	60	1 078	>0.9	<20	50	20
66954	LUMEINA/MOD/IC/6W/35K/22/STD	6	120	3 500	750	125	90+	50 000	22	3 533	>0.9	<20	50	20
66955	LUMEINA/MOD/IC/6W/35K/36/STD	6	120	3 500	750	125	90+	50 000	36	1 843	>0.9	<20	50	20
66956	LUMEINA/MOD/IC/6W/35K/60/STD	6	120	3 500	750	125	90+	50 000	60	1 190	>0.9	<20	50	20
66957	LUMEINA/MOD/IC/6W/40K/22/STD	6	120	4 000	750	125	90+	50 000	22	3 558	>0.9	<20	50	20
66958	LUMEINA/MOD/IC/6W/40K/36/STD	6	120	4 000	750	125	90+	50 000	36	1 867	>0.9	<20	50	20
66959	LUMEINA/MOD/IC/6W/40K/60/STD	6	120	4 000	750	125	90+	50 000	60	1 121	>0.9	<20	50	20
Non-IC (not for use in insulated ceiling)														
64709	LUMEINA/MOD/9W/30K/22/STD	9	120	3 000	950	106	90+	50 000	22	3 524	>0.9	<20	50	20
64710	LUMEINA/MOD/9W/30K/36/STD	9	120	3 000	950	106	90+	50 000	36	2 121	>0.9	<20	50	20
64711	LUMEINA/MOD/9W/30K/60/STD	9	120	3 000	950	106	90+	50 000	60	1 305	>0.9	<20	50	20

¹ QUICK SHIP: Product availability is subject to change without notice. Please contact your Stanpro customer service representative to confirm inventory levels at time of order.

² Typical color temperature range: +/- 5 %.

³ Lumen values are derived from photometric testing. Initial lumens range: +/- 10 %.

⁴ Life hours are derived from IESNA LM-80-08 testing report and projected per IESNA TM-21-11 extrapolations.



LED DRIVERS (INCLUDED WITH LED MODULES)

Order code	System watts	Max load	Input volts	Output volts	Input current
	(W)	(W)	(VAC)	(VDC)	(mA)
Lumeina 6W	9	9	120	30-38	200
Lumeina 9W	12	12	120	30-38	260

QUICK SHIP TECHNICAL SPECIFICATION TABLE TRIMS ☎️¹

Order code	Part number	Type	Shape	Finish / color	Diameter		Cutting diameter		Compatible mounting plate	Compatible vapor barrier	Case qty
					(in.)	(mm)	(in.)	(mm)			
IC (can be used in insulated ceiling)											
64731	LUMEINA/TRIM/GMB.REC/WH/STD	Gimbal	Round	White	3 17/32	90	3	77	66046	66142	50
64733	LUMEINA/TRIM/GMB.BAF/WH/STD	Gimbal	Round	White	4 1/8	105	3 1/2	89	66048	66143	50
64735	LUMEINA/TRIM/SQR_RND/GMB/WH/SM/STD	Gimbal	Square	White	4 7/16	113	3 1/8	80	62673, 66047, 66054	66143	50
64741	LUMEINA/TRIM/GMB.CURVED/WH/STD	Gimbal	Round	White	4 11/32	110	3 3/4	95	66050, 62771	66143	50
64742	LUMEINA/TRIM/SQR_RND/GMB/WH/LRG/STD	Gimbal	Square	White	4 7/16	113	3 3/4	95	66050, 62771	66143	50
64732 ^{1,2}	LUMEINA/TRIM/SWR/WH/STD	Shower	Round	White	3 17/32	90	3	77	66046	66142	50
64734	LUMEINA/TRIM/D.BAF/WH/STD	Deep baffle	Round	White	3 15/16	100	3 1/2	89	66048	66143	50
64736	LUMEINA/TRIM/SQR_RND/REC/WH/STD	Recessed	Square	White	3 5/32	80	2 3/4	70	66020, 66021, 66819	66142	50
64737	LUMEINA/TRIM/CURVED/WH/STD	Curved	Round	White	3 1/16	78	2 3/4	70	66020, 66021, 66819	66142	50
Non-IC (not for use in insulated ceiling)											
64743	LUMEINA/TRIMEXT/STD	Trim extension	Round	White	1 31/32	50	-	-	-	-	50

¹ QUICK SHIP: Product availability is subject to change without notice. Please contact your Stanpro customer service representative to confirm inventory levels at time of order.

² Typical color temperature range: +/- 5 %.

Data is based upon tests performed in a controlled environment. Actual performance can vary depending on operating conditions. All products are subject to change or may be discontinued any time without notice.

QUICK SHIP TECHNICAL SPECIFICATION TABLE TRIMS WITH REFLECTOR ☺¹

Order code	Part number	Type	Finish / color	Diameter		Cutting diameter		Compatible mounting plate	Compatible vapor barrier	Case qty (master)
				(in.)	(mm)	(in.)	(mm)			
Non-IC (not for use in insulated ceiling)										
64738	LUMEINA/TRIM/RFL_WH/STD	Reflector	White/Chrome	3 17/32	90	3	77	66046	66142	50
64739	LUMEINA/TRIM/RFL_SLV/STD	Reflector	Silver/Chrome	3 17/32	90	3	77	66046	66142	50
64740	LUMEINA/TRIM/RFL_BLK/STD	Reflector	Black/Chrome	3 17/32	90	3	77	66046	66142	50

¹ **QUICK SHIP:** Product availability is subject to change without notice. Please contact your Stanpro customer service representative to confirm inventory levels at time of order.



64738



64739



64740

ACCESSORIES (order separately)

Order code	Type	Opening diameter (in.)	Case qty (master)
66020	Square mounting plate	2 3/4	96
66021	Adjustable mounting plate	2 3/4	24
66819	Mounting plate with hanger bars	2 3/4	25
66046	Square mounting plate	3	96
66142	Vapor barrier extender	3 5/8	50
66048	Square mounting plate	3 1/2	96
66047	Square mounting plate	3 1/4	96
66054	Adjustable mounting plate	3 1/4	24
62673	Mounting plate with hanger bars	3 1/4	20
66050	Square mounting plate	3 3/4	96
62771	Mounting plate with hanger bars	3 3/4	20
66143	Vapor barrier extender	4 1/4	50
62672	Insulated box with hanger bars	3 to 4 1/2	4

¹ Includes brackets and screws.

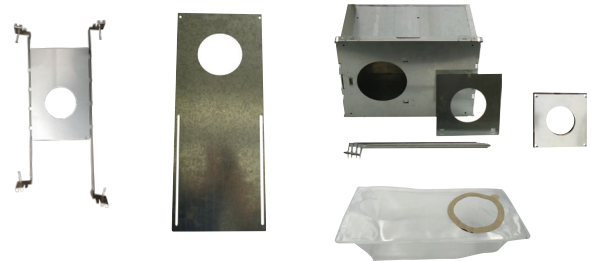

Data is based upon tests performed in a controlled environment. Actual performance can vary depending on operating conditions. All products are subject to change or may be discontinued any time without notice.

COMPATIBLE DIMMERS

Brand	Product type & dimmer model number	
	IC	NON-IC
Legrand		HCL453P
Cooper	AAL06, SLC03P	9531AW, DAL06P, AAL06, SLC03P
Leviton	IPL06, 6674, DSL06-1LZ, IPE04-1LZ	6615, IPL06, 6674, DSL06-1LZ, DSM10-1LZ, IPE04-1LZ
Lutron	AYCL-253P, CTCL-153P, DVCL-153P, DVCL-253P, DVELV-300P, SELV-300P	CTCL-153P, AYCL-253P, DVELV-300P, SELV-300P, NTELV-600P

Dimming range 10%-100%

NOTE: The above table shows dimmers that have been tested and have demonstrated proper operation under normal conditions. Each installation being unique, various factors such as load, common neutrals or other electrical products on the circuit can, in certain instances, cause variance in system performance. Read and comply to the dimmer installation instructions. Consult dimming system manufacturer for additional support in operation. Standard recommends to use dimmers designed to work with LED products. Older dimmers designed for incandescent products may cause erratic operation. Some dimmers may require more than one product for stable operation. The maximum number of products is determined by the dimmer wattage rating with LEDs. Be careful, these dimmers have different ratings depending on the product type. Again, refer to the dimmer installation instructions.

DIMENSIONS

LED DRIVER 6 W AND 9 W

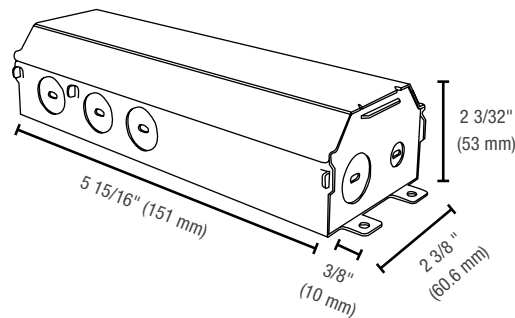

LUMEINA™ MODULE 6 W AND 9 W

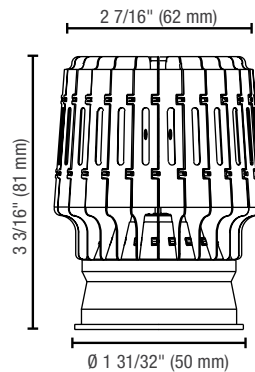

Data is based upon tests performed in a controlled environment. Actual performance can vary depending on operating conditions. All products are subject to change or may be discontinued any time without notice.

PHOTOMETRIC DATA¹

66695 • LUMEINA/MOD/IC/6W/27K/22/STD • 760.4 lm

Polar candela distribution

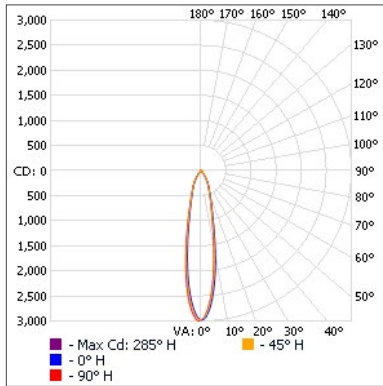

Zonal lumen summary

Zone	Lumens	% Fixture
0-30	632.6	83.2
0-40	719.4	94.6
0-60	751.4	98.8
60-90	9.0	1.2
0-90	760.4	100

Illuminance at a distance

Center beam fc	Beam width	
	17.0'	6.4'
17.0'	10.3	6.4'
34.0'	2.58	12.7'
51.0'	1.14	19.1'
68.0'	0.64	25.5'
85.0'	0.41	31.9'
102.0'	0.29	38.2'

Vert. spread: 21.2°
Horiz. spread: 21.3°

64707 • LUMEINA/MOD/IC/6W/30K/36/STD • 701.0 lm

Polar candela distribution

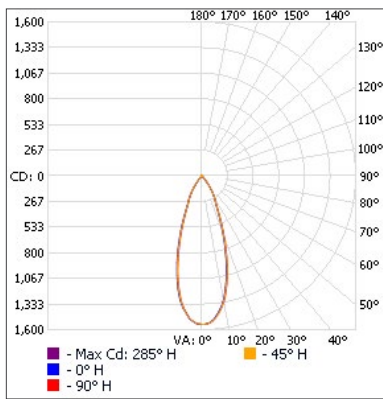

Zonal lumen summary

Zone	Lumens	% Fixture
0-30	590.9	84.3
0-40	681.0	97.2
0-60	697.0	99.4
60-90	3.9	0.6
0-90	701.0	100

Illuminance at a distance

Center beam fc	Beam width	
	17.0'	11.2'
17.0'	5.34	11.2'
34.0'	1.33	22.5'
51.0'	0.59	33.7'
68.0'	0.33	44.9'
85.0'	0.21	56.2'
102.0'	0.15	67.4'

Vert. spread: 36.6°
Horiz. spread: 36.4°

66956 • LUMEINA/MOD/IC/6W/35K/60/STD • 804.5 lm

Polar candela distribution

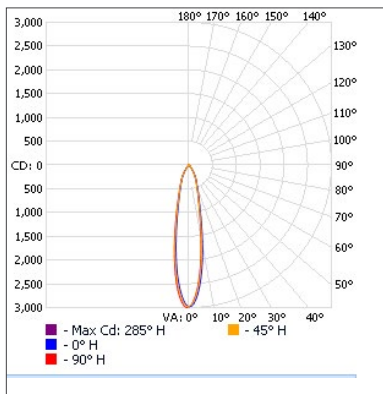

Zonal lumen summary

Zone	Lumens	% Fixture
0-30	647.6	80.5
0-40	780.3	97
0-60	800.3	99.5
60-90	4.2	0.5
0-90	804.5	100

Illuminance at a distance

Center beam fc	Beam width	
	17.0'	16.5'
17.0'	4.07	16.5'
34.0'	1.02	33.1'
51.0'	0.45	49.6'
68.0'	0.25	66.2'
85.0'	0.16	82.7'
102.0'	0.11	99.3'

Vert. spread: 51.9°
Horiz. spread: 51.9°

¹ Complete IES files available on our website.

Data is based upon tests performed in a controlled environment. Actual performance can vary depending on operating conditions. All products are subject to change or may be discontinued any time without notice.

PHOTOMETRIC DATA (cont'd)¹

66958 • LUMEINA/MOD/IC/6W/40K/36/STD • 804.1 lm

Polar candela distribution

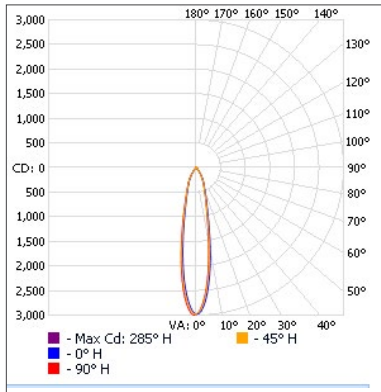

Zonal lumen summary

Zone	Lumens	% Fixture
0-30	695.7	86.5
0-40	786.8	97.8
0-60	800.2	99.5
60-90	3.8	0.5
0-90	804.1	100

Illuminance at a distance

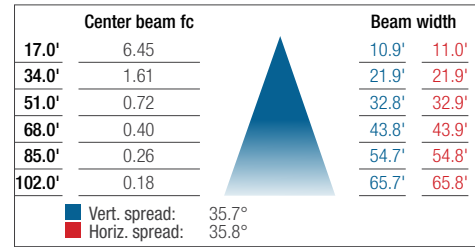

64709 • LUMEINA/MOD/9W/30K/22/STD • 803.3 lm

Polar candela distribution

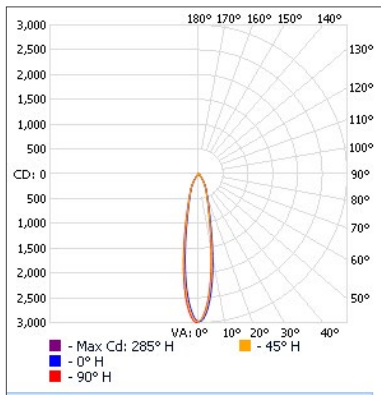

Zonal lumen summary

Zone	Lumens	% Fixture
0-30	666.1	82.9
0-40	763.1	95
0-60	795.7	99
60-90	7.6	1
0-90	803.3	100

Illuminance at a distance

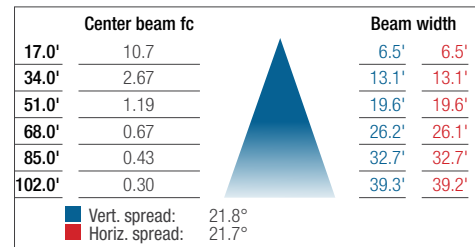

64710 • LUMEINA/MOD/9W/30K/36/STD • 833.3 lm

Polar candela distribution

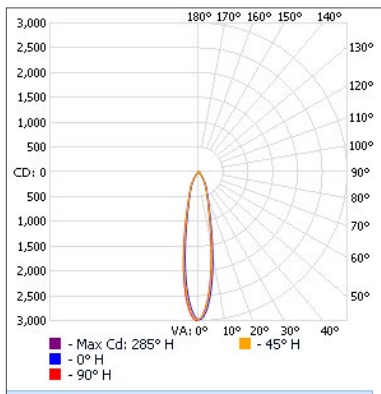

Zonal lumen summary

Zone	Lumens	% Fixture
0-30	702.3	84.3
0-40	809.5	97.1
0-60	828.6	99.4
60-90	4.7	0.6
0-90	833.3	100

Illuminance at a distance

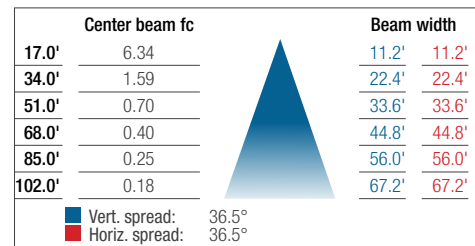

¹ Complete IES files available on our website.

Data is based upon tests performed in a controlled environment. Actual performance can vary depending on operating conditions. All products are subject to change or may be discontinued any time without notice.

PHOTOMETRIC DATA (cont'd)¹

64711 • LUMEINA/MOD/9W/30K/60/STD • 830.2 lm

Polar candela distribution

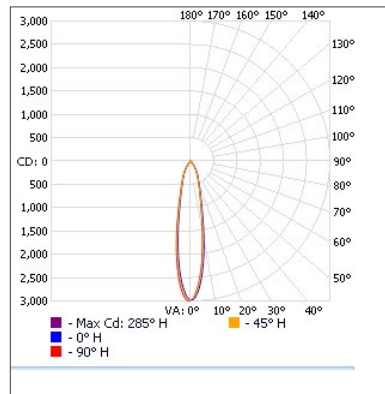

Zonal lumen summary

Zone	Lumens	% Fixture
0-30	636.5	76.7
0-40	803.8	96.8
0-60	825.6	99.4
60-90	4.7	0.6
0-90	830.2	100

Illuminance at a distance

	Center beam fc	Beam width
17.0'	3.74	18.4' 18.2'
34.0'	0.94	36.9' 36.5'
51.0'	0.42	55.3' 54.7'
68.0'	0.23	73.8' 72.9'
85.0'	0.15	92.2' 91.2'
102.0'	0.10	110.6' 109.4'

■ Vert. spread: 56.9°
 ■ Horiz. spread: 56.4°

¹ Complete IES files available on our website.

Data is based upon tests performed in a controlled environment. Actual performance can vary depending on operating conditions. All products are subject to change or may be discontinued any time without notice.