

# TECHNICAL INFORMATION BULLETIN

## LAMP AND BALLAST KIT

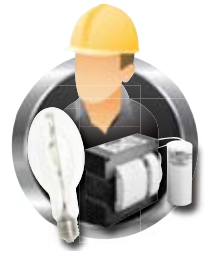

### Ordering Information

Order code: 60988

ANSI code: M59

Description: LBK/BMH0400/TRITAP/C/CWA/MOG

System: Probe Start Metal Halide

UPC: 69549609884

### Ballast Information

Line Voltage	120/277/347V
Regulation	
Line Volts	+/-10%
Line Watts	+/-10%
Frequency	60 Hz
Circuit Type	CWA
Power Factor (min)	90%
Insulation Class	H(180°)
Min. Ambient Starting Temp.	-20° F or -30° C

Line Voltage (Volts)	120	277	347
Line Current (Amps)			
Operating	4.0	1.70	1.40
Open Circuit	3.50	1.60	1.30
Starting	2.90	1.30	1.00
Input Watts (W)	458	458	458
Open Circuit Voltage (V)	300	300	300
Drop Out Voltage (V)	60	140	175
UL(1029) Bench Top Rise	B	D	D
Recommended Fuse (Amps)	10	5	4

#### HIGH POTENTIAL TEST (VOLTS)

1 Minute 2000

2 Seconds 2500

Open Circuit Voltage Test(volts) 270-330

Short-Circuit Current Test (Amps)

Secondary Current 3.4 - 4.2

Input Current (Amps) 2.50 - 1.05 - 0.85 -

3.10 1.40 1.10

#### 4 1/4" x 4 3/4" CORE

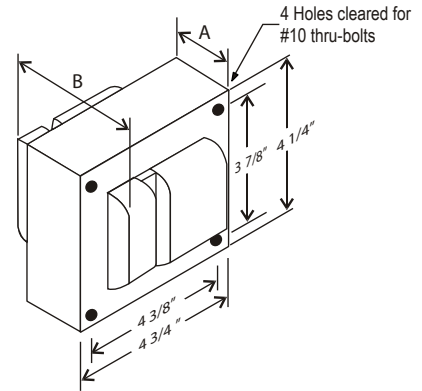

#### CORE AND COIL

Dimension A (inches)	2.00
Dimension B (inches)	3.70
Weight (Lbs)	13.00
Lead Lengths (inches)	12

#### CAPACITOR

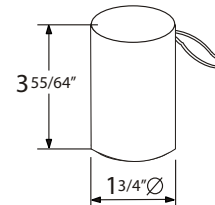

RATING  
24 Mfd ± 3%  
400 VAC MIN  
Dry Film Capacitor  
Thermal Plastic Case  
Max. Case Temp 100° C  
NO PCB'S

#### BRACKET

CORE & COIL  
MOUNTING BRACKET

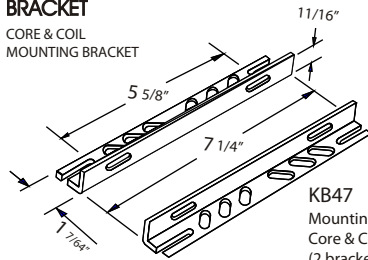

KB47  
Mounting bracket for  
Core & Coil Ballasts  
(2 brackets with thru bolts)

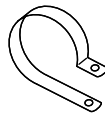

#### C-01

MOUNTING CLIP for round  
case (Furnished as standard  
with B suffix ballast)

#### WIRING DIAGRAM

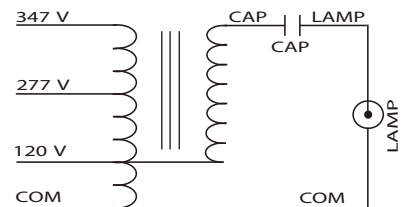

120/277/347 VOLT CONNECTION



Data is based upon tests performed in a controlled environment and representative of relative performance. Actual performance can vary depending on operating conditions. Specifications are subject to change without notice.



www.standardpro.com

# TECHNICAL INFORMATION BULLETIN

## LAMP AND BALLAST KIT

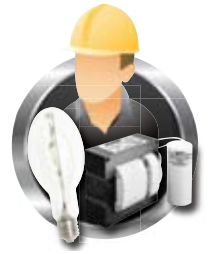

### Ordering Information

Order code: 60988

ANSI code: M59

Description: LBK/BMH0400/TRITAP/C/CWA/MOG

System: Probe Start Metal Halide

UPC: 69549609884

### Lamp Information

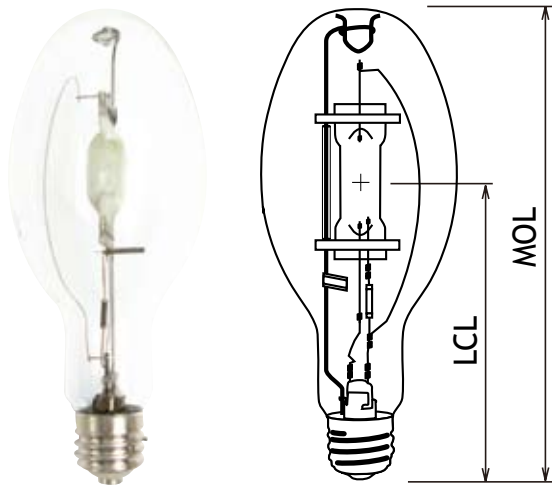

Wattage (W):	400
Initial lumens (lm):	36 000
Mean lumens (lm):	23 000
Lumens per watt (lm/W):	90
Lamp voltage (V):	135
Colour temperature (K):	4 000
Chromaticity (x,y):	0.385, 0.390
CRI:	65
Average life (hrs):	20 000
Lamp lumen depreciation:	0.65% @ 8 000 hrs
Warm up time to 90% (min):	3-5
Hot restart time to 90% (min):	8-12
Burn Position:	Universal
Dimming:	50% rated power
Max base temperature:	210
Max lamp temperature:	400
Socket pulse rating (kV):	N/A



### Spectral Distribution

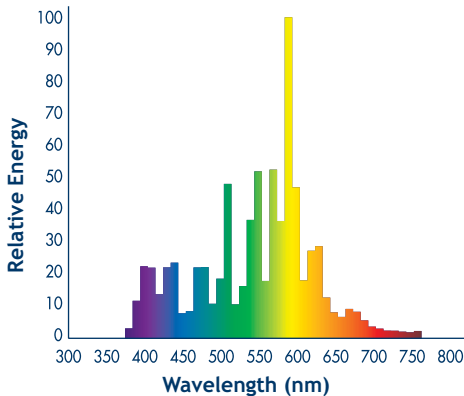

### Physical data / Requirements

Shape:	ED37
Base:	Mog Base E39
Finish:	Clear
Luminaire rating:	Enclosed Rated
Diameter (mm/in.):	117.5 (4 5/8)
MOL (mm/in.):	292.0 (11 1/2)
LCL (mm/in.):	178.0 (7)
Effective arc length (mm):	35.4
Mercury Content (mg):	55

### Warning

“R” **WARNING:** this lamp can cause serious skin burn and eye inflammation from shortwave ultraviolet radiation if the outer envelope of the lamp is broken or punctured. Do not use where people will remain for more than a few minutes unless adequate shielding or other safety precautions are used. Lamps that will automatically extinguish when the outer envelope is broken or punctured are commercially available. Complies with USA Federal Standard 21 CFR 1040.30 and Canada Standard SOR/80-381.

