

GFK-0684G
November 1999

VME Integrator Racks, 17 Slot Front and Rear Mount

Features

- Accepts 3rd Party VME modules which require 0.8" spacing.
- Accepts all IC697 PLC module types.
- Rear mount rack mounts in a 10" (254 mm) deep enclosure.
- Front mount rack mounts in a standard 19" (483 mm) rack.
- Accepts plug-in AC/DC and DC IC697 power supplies, or can use external supply (Power Supply Adaptor module required).
- Provision for two rack operation from single power supply.
- Provision for power supply for high-current configurations.
- Optional accessory kit available for adding J2 backplane or making ribbon cable connections to J2 backplanes.
- Optional fan assembly (for high-power modules).

Functions

The VME Integrator Rack for the IC697 Programmable Logic Controller can be used for 3rd party VME modules and all IC697 CPU and I/O configurations, except redundancy applications. This rack has a 17-slot backplane and is designed to provide easy integration of 3rd party VME modules into an IC697 PLC system. **Integration of 3rd Party VME modules must be in accordance with guidelines which are described in the User's Guide to Integration of 3rd Party VME Modules.**

Backplane connectors are spaced on 0.8 inch centers to accommodate 3rd party VME modules. IC697 modules each use two of these slots. *Standard IC697 racks have slots spaced on 1.6 inch centers for IC697 modules.* VME modules that require 0.8 inch spacing for installation in a rack may not fit in the standard IC697 rack (IC697CHS750/790/791).

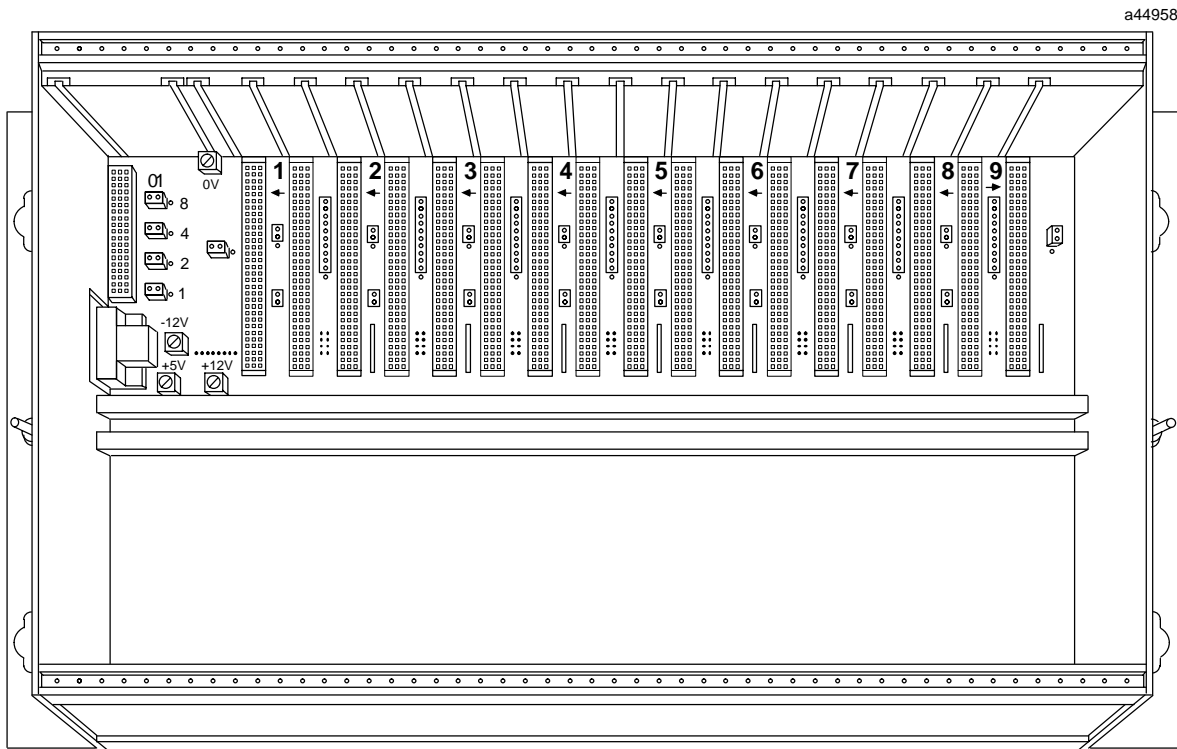

VME Integrator Racks, 17 Slot Front and Rear Mount

GFK-0684G
November 1999

These racks accommodate two module types. First, rack-type IC697 high-density I/O modules, which use a detachable field wiring terminal board. Each I/O module will accept up to forty AWG #14 (2.10 mm²) wires. The wire bundle is routed out the bottom of

the terminal board cavity where a cleat is provided for a tie wrap to secure the bundle to the terminal board housing. The second type of modules are VME modules which may have varying methods of connecting to field devices.

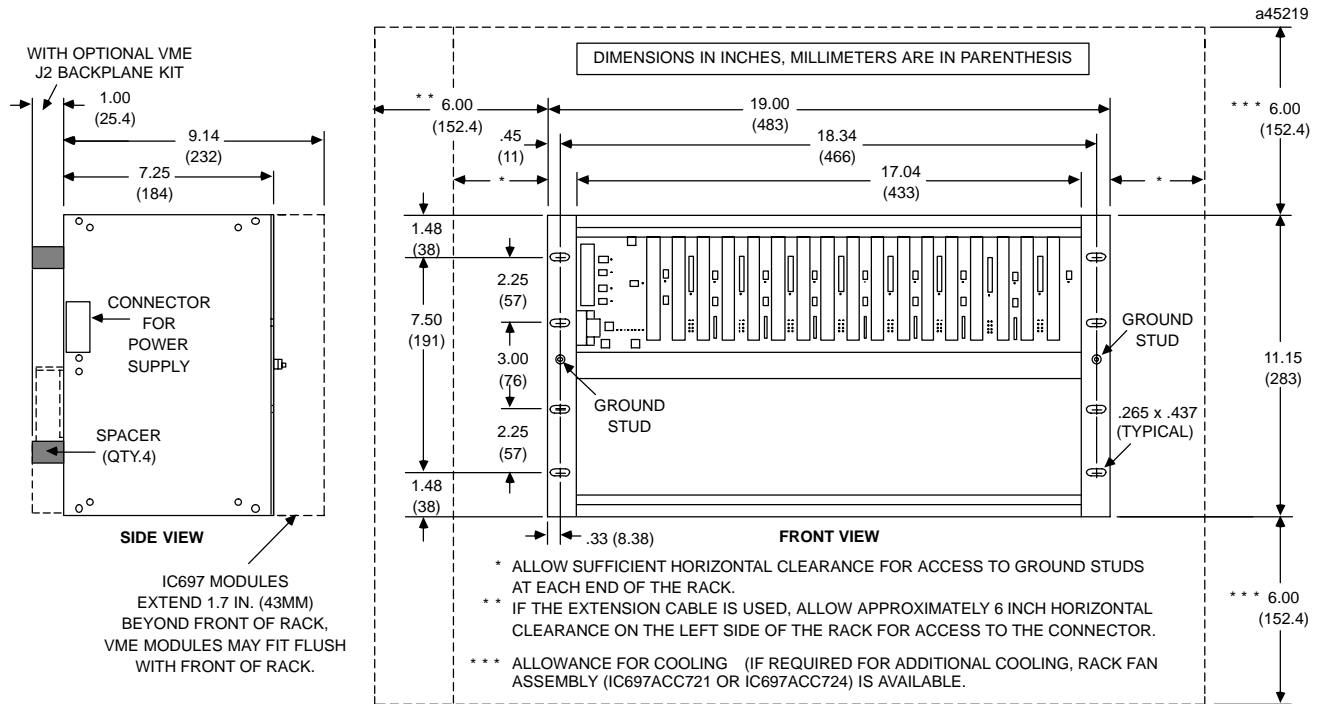

Figure 2. VME Integrator Rack Dimensions for Panel (Front) Mount

Configuring the VME Integrator Rack

A series of jumper positions are located on the backplane near each slot. These jumpers provide for flexibility in the types of modules to be installed, either VME modules in single slots (0.8 inch spacing between centers) or IC697 modules, which require two slots (1.6 inch spacing between centers). IC697 module slots are indicated by a number and an arrow: also these slots are marked 1A through 9A.

Table 1 on page 5 shows the relationship of the slot numbers to the jumper numbers. The functions and signals which are configurable by these jumpers are:

- select a rack ID for multiple rack systems (IC697 feature).
- configure SYSFAIL signal to be enabled or disabled (per slot).
- configure LWORD signal in slot 1 to be inactive.
- configure IRQ1/ - IRQ4/ signals for VME slots 12PL to 19PL.
- configure Bus Grant signals for VME slots 12PL to 19PL.

GFK-0684G
November 1999

VME Integrator Racks, 17 Slot Front and Rear Mount

The following figure is an example of the location of these jumpers on the backplane. The jumpers shown are referenced in the text following the figure.

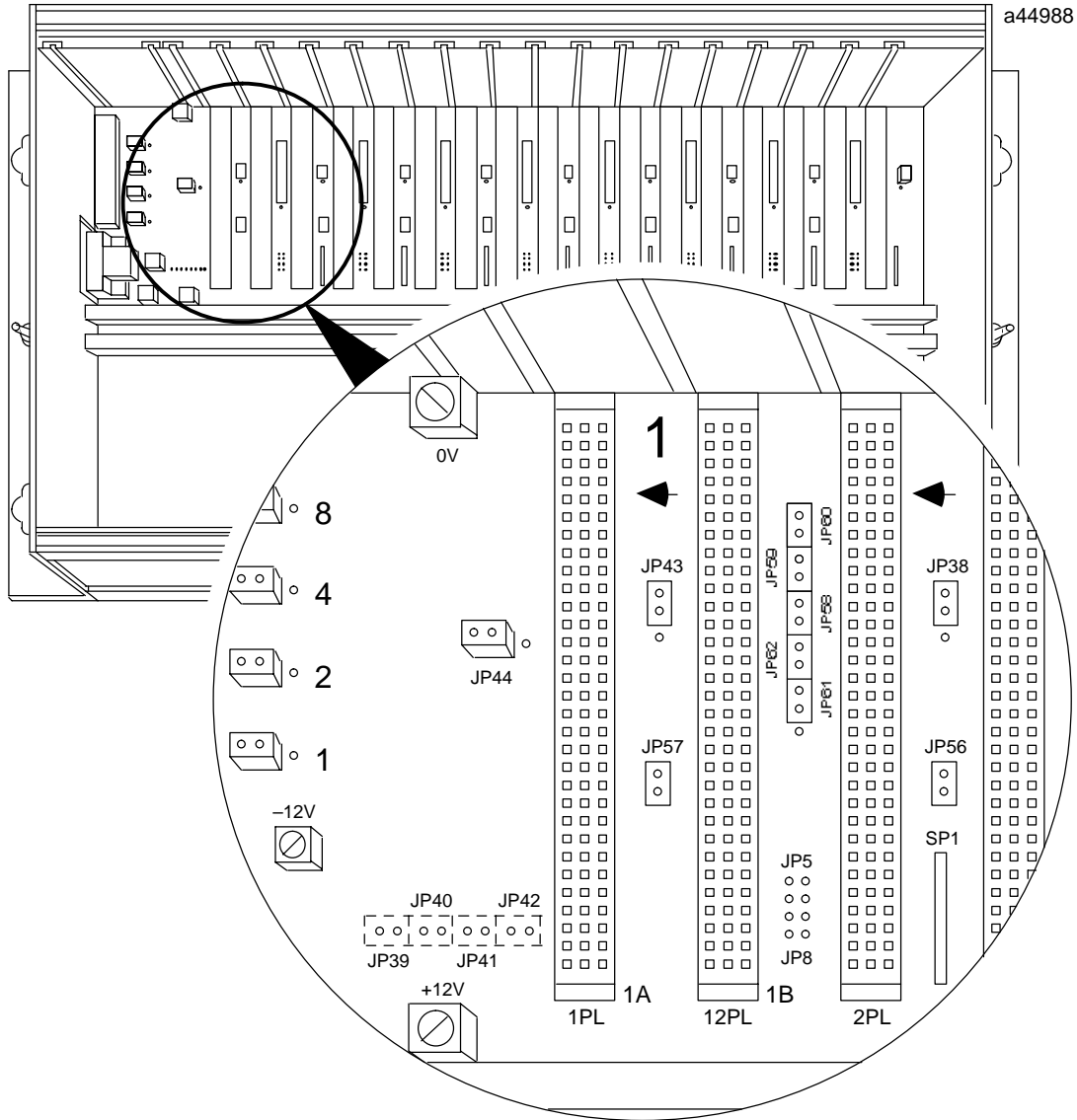

Figure 3. Example of Jumper Locations on Backplane

VME Integrator Racks, 17 Slot Front and Rear Mount

GFK-0684G
November 1999

Default Jumper Configurations

The following table describes the jumper configuration for each of the configurable VME rack signals. The default configuration for each of these signals is shown following the table. Table 2 on the next page lists all of the jumpers and their associated slots.

Table 1. Jumper Descriptions

SignalName or Function	See	ApplicableJumpers	Description
Rack ID Select	-	JP1 to JP4	Selects rack ID number 0 -7, see text for settings (default rack ID = 0)
SYSFAIL/	A	See Table 1 for jumper numbers.	Enabled or disabled for each slot (default = enabled).
LWORD/	B	JP44	Slot 1 only, set to active or inactive (default=inactive).
IRQ1/toIRQ4/(Interrupt lines)	C	See Table 1 for jumper numbers	Select for IC697 module slots 1PL to 9PL. If VME module in slot uses these signals, install jumpers (default = no jumpers).
Bus Grant 0 -3/ and IACK/	D	See Table 1 for jumper numbers	If VME modules are installed that pass daisy chain signals, jumpers must be removed in VME slots 12PL to 19P (default = jumpers).

A configuration selection consists of a jumper plug which is placed over two adjacent pins. In some cases (such as LWORD jumper), this pin is placed over 2 of 3 in-line pins; other selections require the jumper plugs to be present or not be present. Factory default jumper positions are shown below with shaded areas representing a jumper that is present. **The configuration example shown below is for slot 12PL. The physical arrangement for the other connectors is the same, only the jumper numbers (JPxx) are different.**

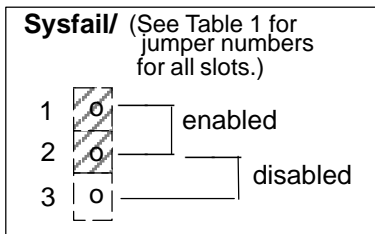

A

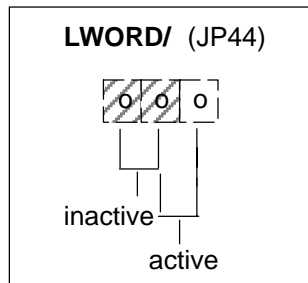

B

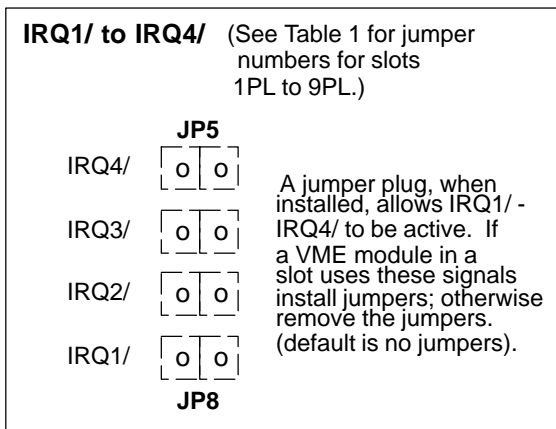

C

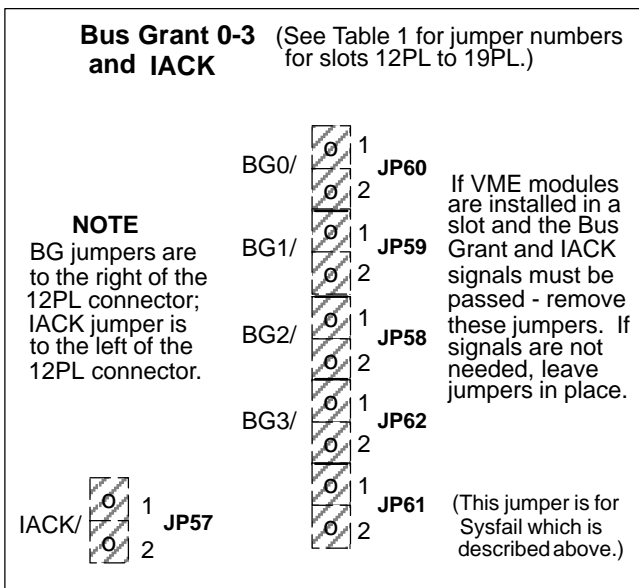

D

* shaded boxes represent default positions

GFK-0684G
November 1999

VME Integrator Racks, 17 Slot Front and Rear Mount

The following table is a list of the slots and jumpers associated with each slot. Multiple jumpers listed in a column under a signal are shown in the same numer-

ical order as they appear on the backplane (that is, left to right or top to bottom).

Table 2. Jumper Location and Function

SlotNumber	Bus Grant 0→3 Jumpers	IACK Jumper	Sysfail Jumper	IRQ1/toIRQ4/ Jumper
1VME-12PL(1B)	JP60,59,58,62	JP57	JP61	-
2VME-13PL(2B)	JP53,54,55,51	JP56	JP52	-
3VME-14PL(3B)	JP66,65,64,68	JP63	JP67	-
4VME-15PL(4B)	JP72,71,70,74	JP69	JP73	-
5VME-16PL(5B)	JP78,77,76,80	JP75	JP79	-
6VME-17PL(6B)	JP84,83,82,86	JP81	JP85	-
7VME-18PL(7B)	JP90,89,88,92	JP87	JP91	-
8VME-19PL(8B)	JP96,95,94,98	JP93	JP97	-
1GEF-1PL(1A)	-	-	JP43	JP39,40,41,42
2GEF-2PL(2A)	-	-	JP38	JP8,7,6,5
3GEF-3PL(3A)	-	-	JP99	JP12,11,10,9
4GEF-4PL(4A)	-	-	JP45	JP16,15,14,13
5GEF-5PL(5A)	-	-	JP46	JP20,19,18,17
6GEF-6PL(6A)	-	-	JP47	JP24,23,22,21
7GEF-7PL(7A)	-	-	JP48	JP28,27,26,25
8GEF-8PL(8A)	-	-	JP49	JP32,31,30,29
9GEF-9PL(9A)	-	-	JP50	JP36,35,34,33

There are three basic configurations of modules that can be accommodated by the VME Integrator rack: (1) Standard (IC697 modules only), (2) IC697 controller and IC697 modules and/or 3rd party VME modules, or (3) 3rd party VME modules only. Refer to Table 2 for jumper numbers and their functions.

(1) Standard Configuration

This configuration consists of an IC697 CPU or Bus Receiver in slot 1PL and IC697 modules in the remaining applicable slots (2PL to 9PL).

Note

Do not install IC697 modules in VME slots 12PL to 19PL.

Standard Configuration Jumper Positions

Refer to Figure 2 which is an example of jumper positions and numbers per slot.

- JP1 through JP4 (rack ID jumpers) jumpered to the proper position for Rack ID, where applicable.
- JP43 remains in its default position (as shipped from factory). This allows the SYSFAIL signal to be activated by the IC697 CPU.
- JP44 remains in its default position. This jumpers the LWORD signal in slot 1 to be inactive allowing only 16-bit wide data transfers.
- All other jumpers remain in their factory set default positions.

(2) IC697/VME Configuration

This configuration consists of an IC697 CPU or Bus Receiver module in slot 1P and a combination of IC697 modules and 3rd party VME modules in the remaining slots. IC697 modules can be placed in slots 2PL to 9PL

VME Integrator Racks, 17 Slot Front and Rear Mount

GFK-0684G
November 1999

only. 3rd party VME modules can use the VME slots 12PL to 19PL and slots 2PL to 9PL. Note that all slots have a jumper that allows you to disable the SYFAIL/signal to that slot by removing the appropriate jumper.

Note

Integration of 3rd Party modules must be in accordance with guidelines described in the *User's Guide to Integration of 3rd Party VME Modules*.

IC697/VME Jumper Positions

- JP 1 through JP4 (rack ID jumpers) jumpered to the proper position for Rack ID.
- JP43 remains in its default position (as shipped from factory). This allows the SYSFAIL signal to be activated by the IC697 CPU (SYSFAIL required by IC697I/O modules).
- JP44 remains in its default position. This jumpers the LWORD signal in slot 1 to inactive (for IC697 modules) allowing only 16-bit wide data transfers.
- VME modules can be installed in either the IC697 module slots (2PL to 9PL) or in the VME slots (12PL to 19PL).
- If VME modules are installed in the IC697 module slots (2PL to 9PL) that use the signals IRQ1/ - IRQ4/, then you must install up to four jumpers, as appropriate, in positions that are located to the immediate left of the IC697 slots in use.
- If the VME modules are installed in VME slots (12PL to 19PL), and the board passes the Bus Grant and IACK signals, you must remove five jumpers for each slot being used. *Leave these jumpers in if the board does not pass the Bus Grant and IACK daisy chain signals.* These jumpers are the top four to the immediate right of the slot being used and the lower (of two jumpers) to the immediate left of the slot being used.

(3) VME Configuration

This configuration consists of a 3rd party Controller in slot 1PL and 3rd party VME modules in the remaining slots (2PL to 9PL and 12PL to 19PL). Note that each slot has a jumper that allows the SYFAIL/signal to be disabled to that slot since all VME modules may not require access to that signal.

VME Jumper Positions

- To configure slot 1 for a 3rd party controller, five jumpers must be moved. There are four jumpers behind the power supply (JP1 to JP4) that must be moved to positions JP39 to JP42 and jumper JP44 must be moved from its default position to the right.
- If VME modules are installed in the IC697 module slots (2PL to 9PL) and they use the IRQ1/ - IRQ4/ signals, then you must install four jumpers in the positions that are located to the immediate left of the IC697 module slots in use.
- If the VME modules are installed in VME slots (12PL to 19PL), and the board passes the Bus Grant and IACK signals, you must remove five jumpers for each slot being used. *Leave these jumpers in if the board does not pass the Bus Grant and IACK daisy chain signals.* These jumpers are the top four to the immediate right of the slot being used and the lower (of two jumpers) to the immediate left of the slot being used.

Power Supply Extension Cable

For many applications, one power supply is sufficient for the power requirements of two racks. This two-rack operation from a single power supply can be implemented if only +5 volt power (± 12 volts not supplied through Power Supply Extension cable) of 5.2 amperes or less is required in the second rack.

A 3-foot Power Supply Extension cable is available (see Ordering Information on the last page of this data sheet) which provides the necessary interconnection. In addition to + 5 volt power, the extension cable includes power sequencing signals necessary for proper system operation.

The Power Supply Extension cable attaches to a 9-pin D type connector located on the backplane. Access to the connector is through a hole in the left side of the rack as shown in the outline drawing (Figures 1 and 2). Adequate clearance (approximately 6 inches) must be provided on the left side of the rack for access to the connector.

This connector can also be used to provide power to a user installed 3rd party J2 backplane. An option kit (IC697ACC715) is available for installing a J2 backplane or making ribbon cable connections. Maximum power that can be supplied to the J2 backplane is 5 VDC at 5.2 amps.

GFK-0684G
November 1999

VME Integrator Racks, 17 Slot Front and Rear Mount

The Power Supply Extension cable must be secured before power is applied. It must not be disconnected during system operation.

Slot Addressing

The IC697 PLC system allows user configuration of I/O point references for modules in a rack without the need for board address DIP switches or jumpers. The address structure is described below. Configuration is done with the MS-DOS® or Windows® programming software configurator function. For more information on configuration, see the *Programming Software User's Manual*.

Note

In order to configure slots 12PL to 19PL, you must have release 4.01 or later of MS-DOS programming software.

Rack Number

Multiple racks in a system must be assigned a rack number from 0 to 7; the CPU rack is always Rack 0. The PLC determines the number of each rack in the system from four binary-encoded configurable jumpers on the rack's backplane.

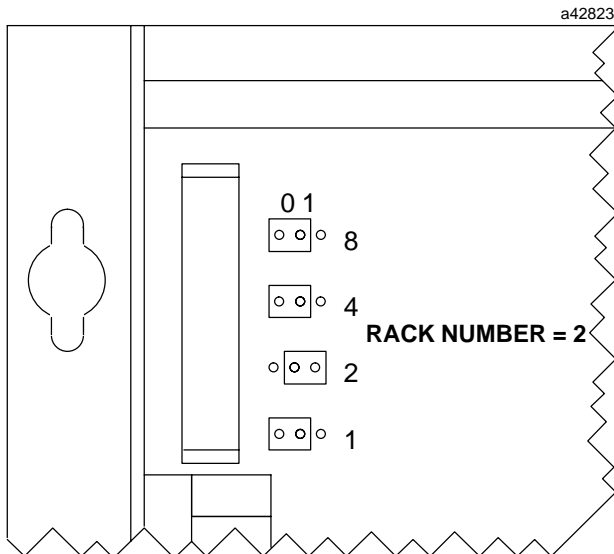

Figure 4. Rack Number Jumpers

These jumpers are located on the backplane directly behind the power supply, which must be removed to gain access to the jumpers.

To set the rack number, move the jumpers corresponding to 1, 2, 4, and 8 bits to either the 0 or 1 position. The sum of the digits in the 1 position equals the desired rack number. For example, rack number 5 would have the 1 and 4 bit jumpers in the 1 position and the 2 and 8 bit jumpers in the 0 position.

Shield Ground

The bottom rail of the rack is used for module shield grounding. Some IC697 I/O modules have a ground clip that contacts the conductive bottom rail when the module is fully inserted. Shield connections in the user connectors are routed to this ground clip through conductors on the module.

Safety Ground

The ground lug on either side of the rack must be connected to earth ground with not less than an AWG #12 (3.33 mm²) wire. The ground lugs are #8-32.

Warning

If the ground lug is not connected to earth ground, the rack is not grounded. The rack must be grounded to minimize electrical shock hazard which may result in severe personal injury.

System Noise Immunity

Three easy steps must be taken to properly ground the IC697 PLC system to reduce the possibility of errors due to electrical noise.

1. Make sure that the power supply mounting screws, especially the bottom two, are properly secured.
2. The GND terminal on the power supply must be connected to the GND terminal on either side of the rack using AWG #12 (3.33 mm²) wire. Use of a ring terminal and star washer is recommended.
3. The GND terminal on the rack must be connected to a good earth ground.

© MS-DOS and Windows are registered trademarks of Microsoft Corporation.

VME Integrator Racks, 17 Slot Front and Rear Mount

GFK-0684G
November 1999

Module Retention

IC697 I/O modules have molded latches that automatically snap onto the upper and lower rails of the rack when the module is fully inserted. **3rd party VME modules do not have these latches.** Optionally, M2.5x8 screws may be used to secure the modules to the rack for high vibration applications.

To remove an IC697 module, first remove the field half of the terminal board (if it is an I/O module), then grasp the top and bottom of the module to depress the latch releases while pulling the module out. For more detailed information on removing I/O terminal boards, refer to the applicable *Programmable Controller Installation Manual* or individual data sheets for I/O modules.

Warning

Do not remove (or insert) modules when either the IC697 power supply or any externally-connected power sources are on. Hazardous voltages may exist. Personal injury, damage to the module or unpredictable operation of the device or process being controlled may result.

If M2.5x8 screws have been used to secure modules to the rack, remove the screws before removing the modules. A blank faceplate is available to cover two consecutive unused slots in the rack.

Rack Fan Assembly

An optional Rack Fan Assembly is available in three versions for installation on the bottom of the rack for additional cooling if forced air cooling is required when a number of high-power VME modules are installed in the rack and heat build-up could be a problem. The Rack Fan Assemblies are:

- IC697ACC721 for 120 VAC power source
- IC697ACC724 for 240 VAC power source
- IC697ACC744 for 24 VDC power source

The fans have a low noise level and are assembled using ball bearings for extended life.

It is recommended that the fans be wired to the same source of power as the IC697 PLC. This will ensure that the fans are running when the PLC is active.

AC Rack Fan Assemblies (IC697ACC721/724): The three fans are wired in parallel using a cable assembly (supplied with the fan assembly) that plugs into the three fan wiring connectors. When the cable assembly is installed, the fan on the left (looking at front of rack) will have a three foot lead with stripped ends for connecting to the applicable 120 or 240 VAC power source.

24 VDC Rack Fan Assembly (IC697ACC744): The three fans each have a pair of 12" (310 mm), 24 AWG leads. Connect these leads in parallel, with all Red leads connected to +24 VDC, and all Black leads connected to 24 VDC Common. Use wire ties to fasten leads down.

The following illustration shows the position of the fan assembly mounted on a rack. Note that it is mounted on the bottom of the rack with air flow from the bottom towards the top of the rack. For detailed specifications and installation instructions, refer to GFK-0637, which is the data sheet for the *Rack Fan Assembly*.

GFK-0684G
November 1999

VME Integrator Racks, 17 Slot Front and Rear Mount

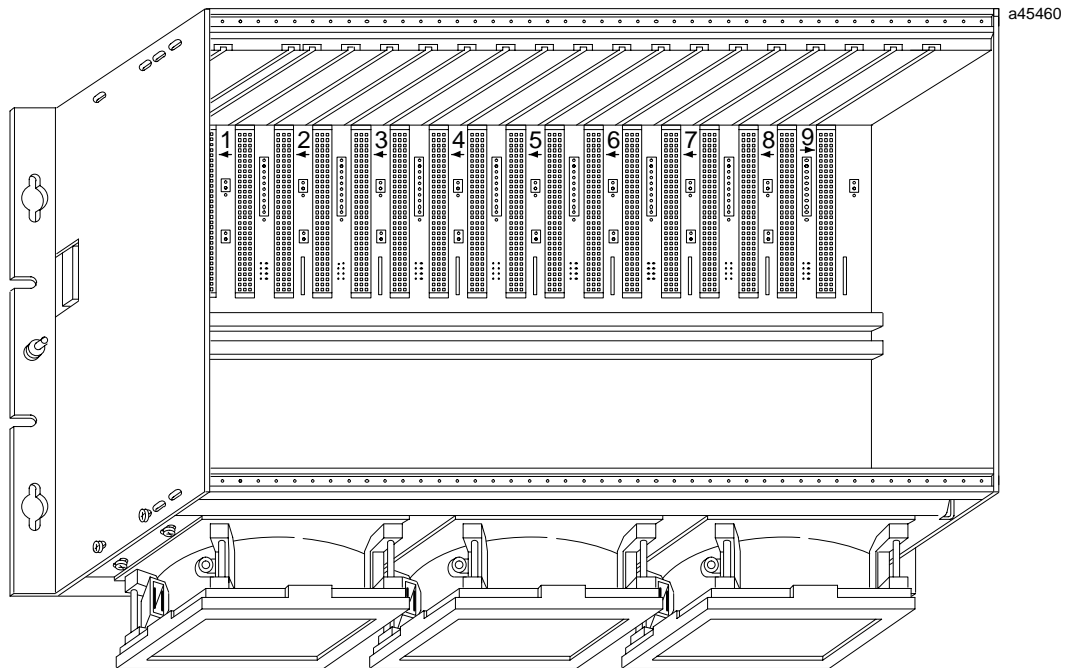

Figure 5. Typical Fan Assembly Mounted on VME Integrator Rack (AC Type Fan Assembly Shown)

Table 3. VME Integrator Rack Specifications †

Number of Slots:	17 on 0.8" centers plus power supply slot												
Maximum 5 Volt Current (from standard IC697 power supplies):	20 amps (100 watt 120/240 VAC or 125 VDC power supply) 11 amps (55 watt 120/240 VAC or 125 VDC power supply) 18 amps (90 watt 24 VDC power supply) 18 amps (90 watt 48 VDC power supply)												
Maximum current (user supplied (not IC697) Power Supply slot J1 only)	3.3 amps (+ 5 VDC) 1.1 amps (± 12 VDC)												
I/O References: Rack Identification: VME/IC697 Slot Configuration:	User configurable with IC641 programming software configurator software Four jumpers (JP1 - JP4) behind rack power supply Configure jumpers on backplane (refer to text)												
Dimensions:	<table border="0"> <tr> <td><i>Height</i></td> <td><i>Width</i></td> <td><i>Depth</i></td> <td><i>(Note that all IC697 modules extend 1.7" (43 mm) beyond front of rack.)</i></td> </tr> <tr> <td>11.15"</td> <td>19.00"</td> <td>7.5"</td> <td></td> </tr> <tr> <td>283mm</td> <td>483mm</td> <td>190mm</td> <td></td> </tr> </table>	<i>Height</i>	<i>Width</i>	<i>Depth</i>	<i>(Note that all IC697 modules extend 1.7" (43 mm) beyond front of rack.)</i>	11.15"	19.00"	7.5"		283mm	483mm	190mm	
<i>Height</i>	<i>Width</i>	<i>Depth</i>	<i>(Note that all IC697 modules extend 1.7" (43 mm) beyond front of rack.)</i>										
11.15"	19.00"	7.5"											
283mm	483mm	190mm											
VME	System designed to support VME standard C.1												

† Refer to GFK-0867B, or later for product standards and general specifications.

VME Integrator Racks, 17 Slot Front and Rear Mount

 GFK-0684G
 November 1999

Table 4. Ordering Information

Description	CatalogNumber
VME Integrator Rack - 17 slots, rear mount	IC697CHS782
VME Integrator Rack - 17 slots, front mount	IC697CHS783
Power Supply Cable Kit (includes cable and faceplate for empty power supply slot)	IC697CBL700
Option Kit for J2 backplane installation (backplane not included)	IC697ACC715
Rack Fan Assembly (optional), 120 VAC	IC697ACC721
Rack Fan Assembly (optional), 240 VAC	IC697ACC724
Rack Fan Assembly (optional), 24 VDC	IC697ACC744

Note: For Conformal Coat option, or Low Temperature Testing option please consult the factory for price and availability.

