



The perfect fit

Philips InteGrade LED fixture system - compact linear LED lighting for standard-size shelves - July 2015



PHILIPS

InteGrade LED fixture system

The InteGrade LED fixture system is an energy-efficient way to create an enjoyable shopping experience. Thanks to its compact dimensions, the fixture can be aesthetically integrated below and inside shelves, e.g. in a store interior or refrigerated cabinet. Asymmetrical optics direct the light where you want it, thus making optimum use of the light and energy. The products or background you want lit will be presented uniformly, with reduced glare and dark spots. Our LEDs have minimal output degradation and color shift, so the light remains consistent throughout their long lifetime. InteGrade LED is an ideal solution for high-quality lighting without flicker or color differences. The fixture consists of a profile with LED engines and inline locks. Mounting accessories, cables and LED power driver are available separately.





Benefits

- Excellent Total Cost of Ownership with attractive payback times
- Aesthetic integration of LED lighting; uniform light distribution
- Easy to install: the fixtures have standard dimensions and so fit most commonly used shelves

Product features

- Energy savings of up to 65% (10 W compared to a 28 W TL5 system)
- Superb asymmetrical optics
- InteGrade cabling allows connection to own connector system
- 5-year Philips warranty (InteGrade LED fixture in combination with Philips cables and Philips LED power driver)

Applications

- Shelf and linear accent lighting in supermarkets, refrigerated cabinets, retail environments, libraries, museums

System

The InteGrade LED fixtures and accessories are designed and marketed together, as we believe good system design is crucial to effective functioning of the system, and it also facilitates an easy design-in.

Specifications

- The rated average life of the fixtures, in combination with a Philips LED power driver, is B50L70 at 50,000 hours (70% lumen maintenance). This rated average life is based on engineering data testing and probability analysis.
- Operating temperature (performance) min - 30 °C / max +30 °C
- Storage temperature min -30 °C / max +60 °C
- Housing color: aluminum
- Safety Extra Low Voltage (SELV)
- Safety is ensured even if wiring or units become damaged (only when a SELV-rated power supply is used)
- Compliance and approval: ENEC, UL, CE, Product safety class III, RoHS, WEEE, EU directive 2002/95/EC
- The fixtures are suitable for the described applications on condition of typical use in dry and damp locations.

InteGrade LED fixture



Installation with InteGrade cable angle

Simple installation

The InteGrade LED fixture comprises a profile with one or more LED engines, one or more connectors, and inline locks. The power cable and driver have to be ordered separately.

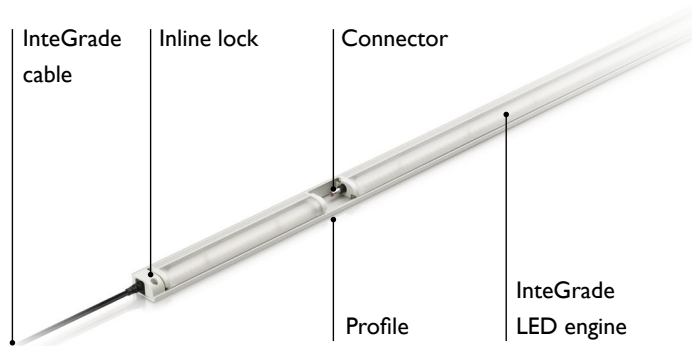

Installation advice

We advise you to consult our website for the latest up-to-date information and important detailed installation instructions. See www.philips.com/ledrefrigeration.

Energy savings

Energy savings are a major benefit of the InteGrade LED fixture compared to TL5 and TL-D systems.

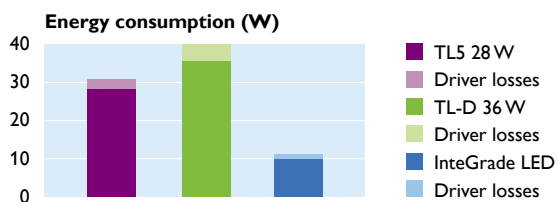

Light distribution diagram

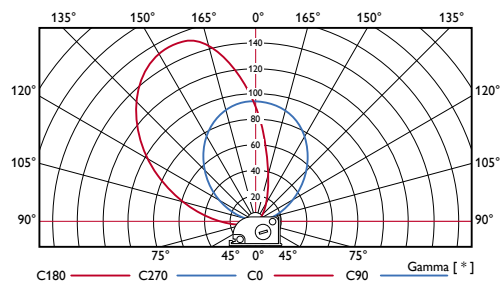

Light distribution InteGrade LED fixtures, all types

Wattage and lighting characteristics InteGrade LED fixture

	Typical power consumption	Lumen	Color Rendering Index (typ)	Correlated Color Temperature*
	W ± 20%	Typical ± 20%	CRI typical	K
InteGrade LED fixture value 875mm(34") 830	8	600	85	3000
InteGrade LED fixture value 875mm(34") 840	8	600	85	4100
InteGrade LED fixture value 875mm(34") WWVR	8	440		
InteGrade LED fixture value 1175mm(46") 830	10	800	85	3000
InteGrade LED fixture value 1175mm(46") 840	10	800	85	4100
InteGrade LED fixture value 1175mm(46") WWVR	10	600		

* Correlated color temperature within 6 SDCM range

Dimensions InteGrade LED fixture

InteGrade LED fixtures	Dimensions (mm)		
	A	B	C
InteGrade LED fixture value 875mm(34")	883	22	12
InteGrade LED fixture value 1175mm(46")	1178	22	12

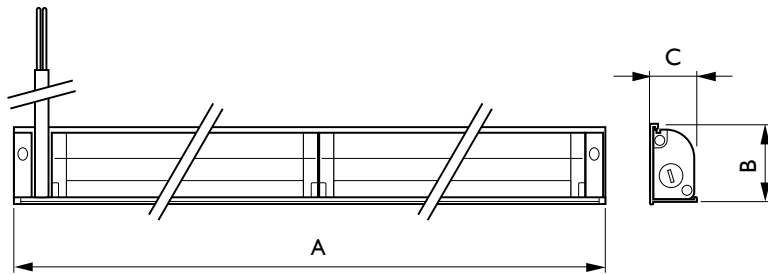

Installation examples

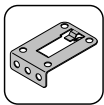

Installation of a LED fixture with mounting clip

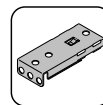
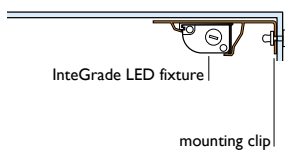

Installation example with shelf-arm mounting clip

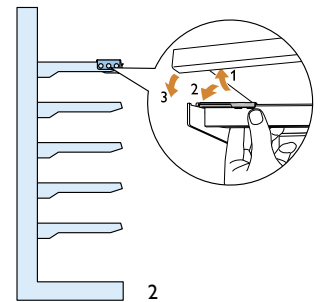
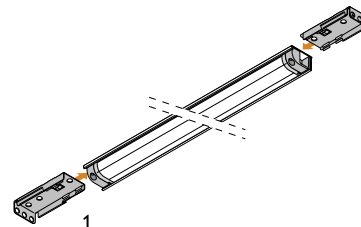

Installation with rotational bracket

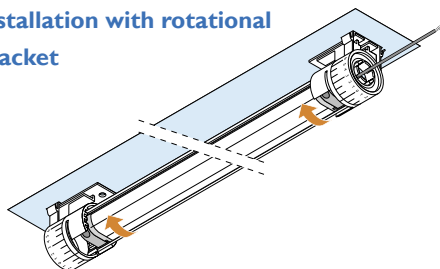

Xitanium LED power driver

We have developed Xitanium Constant Voltage LED power drivers of 20 and 80 W 24V which are ideal for powering the InteGrade LED engines, see ordering table on the last pages. To allow for variance in the installation, we recommend you do not load the power driver beyond 90% of its rated maximum power. Please refer to the wiring diagram in the installation guide for more details.



Xitanium Constant Voltage Outdoor driver 80 W

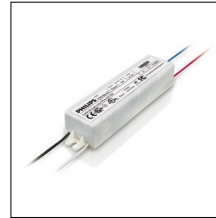
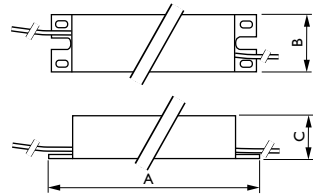

Xitanium Constant Voltage Outdoor driver 20 W

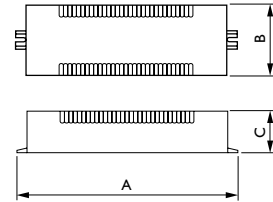

C8-plug

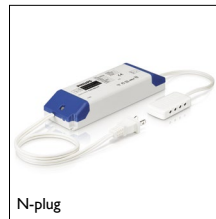

N-plug

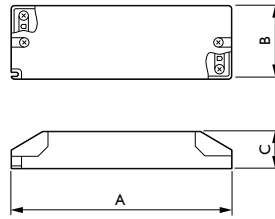

Xitanium Constant Voltage LED Power Driver 75 W

* C8 is for global use. The connector fits to standard C7 to mains connectors - notul N-plug is for North America mainet and has a Na mains plug to directy connect to the mains.

Dimensions Xitanium LED power driver

LED power driver	Dimensions (mm)		
	A	B	C
Xitanium Constant Voltage Outdoor LED Power Driver 20W - 24V	150	37	27
Xitanium Constant Voltage Outdoor LED Power Driver 80W - 24V	241	43	30
Xitanium Constant Voltage LED Power Driver 75W-24V PP ItG-C8 plug*	180	60	31
Xitanium Constant Voltage LED Power Driver 75W-24V PP ItG-N plug*	180	60	31

Accessories

Power cables

The power cables are available in different lengths and colors (black and white). They are easy to connect to the engines and the driver. Specific details can be found in the design-in guide available on our website.

Mounting clips, connector and lock

There are two versions available:

- Shelf-arm mounting clip
- Under-shelf mounting clip

These clips can be easily clicked onto the InteGrade LED fixture.

Rotating bracket

With a 360 degree rotation adjustability in 15 degree steps the rotational bracket allows maximum design

freedom. The cabinet Interface is compatible towards several cut-out patterns for TL type lamp holders.

Spare parts

The connector and inline lock are already included in the LED fixture. The connector is used to electrically connect two LED engines. The inline lock fixes the engine in its profile.



Ordering details for InteGrade LED fixture systems

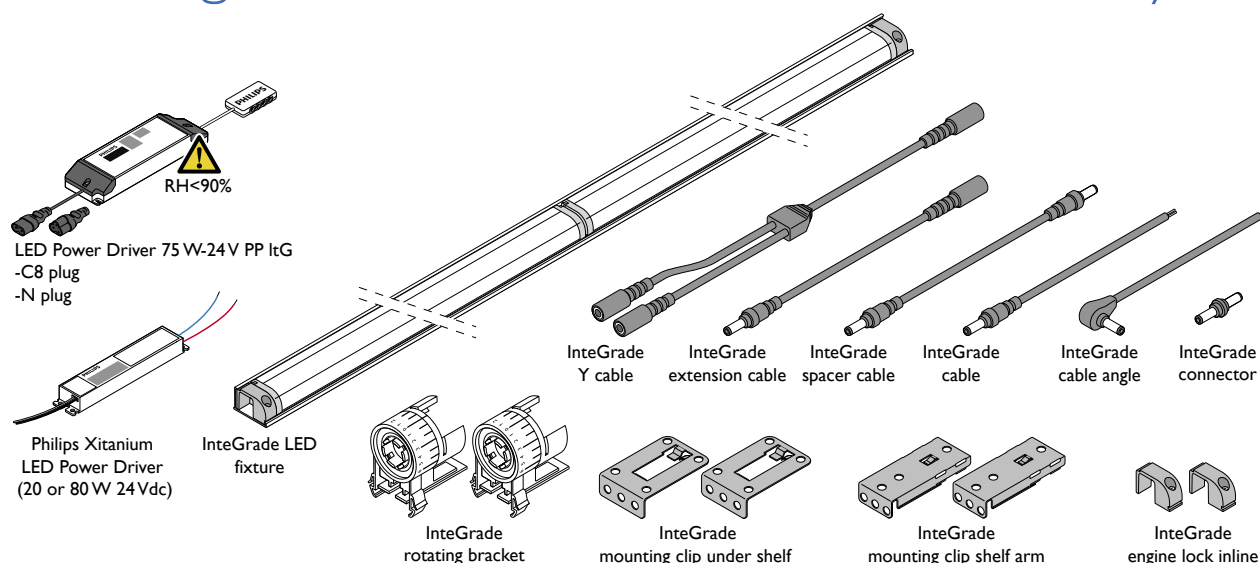

InteGrade LED fixture system

	Logistic code 12 NC	Minimum order quantity pcs
Fixtures		
InteGrade LED fixture value 875mm(34") 830	929000645913	12
InteGrade LED fixture value 875mm(34") 840	929000645713	12
InteGrade LED fixture value 875mm(34") WWWR	929000848813	12
InteGrade LED fixture value 1175mm(46") 830	929000646013	12
InteGrade LED fixture value 1175mm(46") 840	929000645813	12
InteGrade LED fixture value 1175mm(46") WWWR	929000848913	12
InteGrade power cables - to connect engine to driver		
InteGrade power cable 1m(39") black	929000641014	24
InteGrade power cable 2.5m(98") black	929000641114	24
InteGrade cable 1m(39") black angle	929000644614	24
InteGrade cable 2.5m(98") black angle	929000644814	24
InteGrade power cable 1m(39") white	929000645614	24
InteGrade power cable 2.5m(98") white	929000644514	24
InteGrade cable 1m(39") white angle	929000644714	24
InteGrade cable 2.5m(98") white angle	929000644914	24
InteGrade Y cable black*	929000874313	24
InteGrade extension cable 1.5m(59")black	929000874413	24
Mounting parts		
InteGrade shelf-arm mounting clip	929000643803	100
InteGrade under-shelf mounting clip	929000643903	100
InteGrade rotational bracket*	929000874613	100
Power driver		
Xitanium Constant Voltage Outdoor LED Power Driver 20W - 24V	929000654006	10
Xitanium Constant Voltage Outdoor LED Power Driver 80W - 24V	929000653906	10
Xitanium Constant Voltage Outdoor LED Power Driver 75W-24V PP ItG-C8 plug*	929000869713	10
Xitanium Constant Voltage Outdoor LED Power Driver 75W-24V PP ItG-N plug*	929000869613	10
Spare parts		
InteGrade inline lock	929000643713	100
InteGrade connector	929000959106	500

* On request. For availability please contact your local sales office.



© 2015 Koninklijke Philips N.V. All rights reserved. Reproduction in whole or in part is prohibited without the prior written consent of the copyright owner. The information presented in this document does not form part of any quotation or contract, is believed to be accurate and reliable and may be changed without notice. No liability will be accepted by the publisher for any consequence of its use. Publication thereof does not convey nor imply any license under patent or other industrial or intellectual property rights.

Document order number: 3222 635 66998

07/2015

Data subject to change.

www.philips.com/ledrefrigeration

www.philips.com/oem

www.philips.com/supermarketlighting

www.philips.com/ledmodulesna