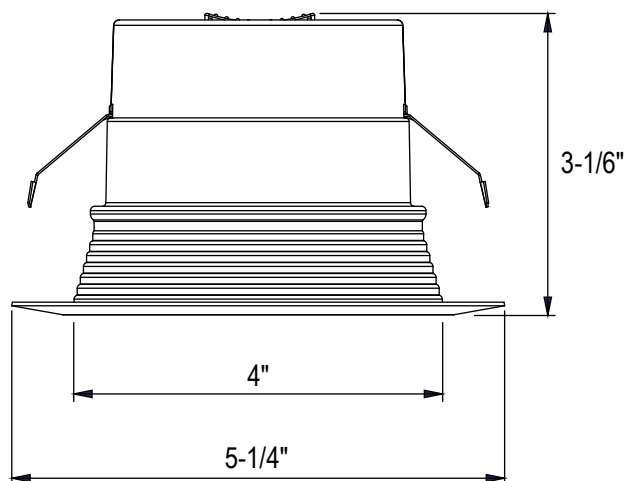

**JUNO**<sup>®</sup>**E Series LED Downlight Retrofit**

4" Switchable White LED Retrofit Module

**4BE/4SE SWW5 Series****Dimensions**

Ships with:

**E26 Adapter**

Project:
Fixture Type:
Location:
Contact/Phone:

**Product Features**

The 4" recessed LED module is the most economical means to create a well lit environment with exceptional energy efficiency and near zero maintenance. Great for retrofit into existing downlight cans or new construction and remodel applications. The LED module maintains at least 70% light output for 50,000 hours.

- 5 switchable white color temperatures to choose from via switch; 2700K, 3000K, 3500K, 4000K, 5000K CCT; 90 CRI
- Lumens: 700L
- Baffle or smooth trim options with designer color finish trim inserts (sold separately)

**Applications**

- Retrofit into existing downlight cans or new and remodel construction in residential and light commercial applications
- Retention clips are pre-installed and designed to fit into most 4" compatible recessed housings
- Wet rated and air-loc: perfect for showers, bathrooms, and outdoor soffits

**Performance**

Delivered Lumens	Nominal 700L at 3000K
LED Color Temperature	Switchable White (2700K, 3000K, 3500K, 4000K, 5000K) Default set at 3000K
CRI	90+
Voltage	Dedicated 120V
Dimming	Dimmable flicker-free dimming from 100% to 10%

For a list of compatible dimmers see JUNOESERIES-DIM

**Specifications**

Aperture:	4"
Ceiling opening:	4.25"
Overlap trim:	5.25"
Height:	3.16"



# E Series LED Downlight Retrofit

4" Switchable White LED Retrofit Module



## ORDERING INFORMATION

### Downlight

Example: 4BEMW SWW5 90CRI

Series	Color Temperature	Rendering Index
<b>4BEMW</b> 4" Juno E Series Baffle Retrofit Downlight	<b>SWW5</b> Switchable White (2700K, 3000K, 3500K, 4000K, 5000K)	<b>90CRI</b> 90+ CRI
<b>4SEMW</b> 4" Juno E Series Smooth Retrofit Downlight		

#### Housing options : Order as separate catalog number.

**L3LED T24** 4" new construction housing LED base

**L3RLED T24** 4" remodel housing LED base

**L3** 4" new construction housing

**L3R** 4" remodel housing

**IC1** 4" new construction housing

**IC1 LEDT24** 4" dedicated LED new construction housing

**IC1R LEDT24** 4" dedicated LED remodel housing

**IC1FW LEDT24** 4" fire-rated dedicated LED new construction housing

#### Accessories: Order as separate catalog number.

**LEDRETROWHIP** Replacement E26 screw base adapter for installation into incandescent housings

## TRIM INSERTS

TRIM INSERTS (for field configuration; ordered separately)

Example: 4BEMB R4

Series/Finish	Packaging
<b>4BEMB</b> 4" Baffle, Matte Black	R4 Retail Pack of 4 units
<b>4BEBN</b> 4" Baffle, Brush Nickel	
<b>4BEORB</b> 4" Baffle, Oil-Rubbed Bronze	
<b>4SEMB</b> 4" Smooth, Matte Black	
<b>4SEBN</b> 4" Smooth, Brush Nickel	
<b>4SEORB</b> 4" Smooth, Oil-Rubbed Bronze	



4" Baffle, Matte Black (4BEMB)



4" Baffle, Brush Nickel (4BEBN)



4" Baffle, Oil-Rubbed Bronze (4BEORB)



4" Smooth, Matte Black (4SEMB)



4" Smooth, Brush Nickel (4SEBN)



4" Smooth, Oil-Rubbed Bronze (4SEORB)

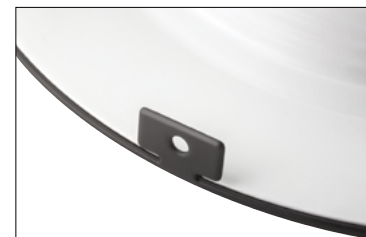

Pre-Install color finish trim insert over white 4" E Series Module.



Press down color finish tabs for post-installation to create final LED 4" module.



# E Series LED Downlight Retrofit

4" Switchable White LED Retrofit Module



## Specifications

### LED Downlight Retrofit Trim

Aluminum spun reflector with deep regression for reduced glare • Inner reflector cone funnels light through the pressed-in diffused lens • All-in-one design where LED light engine mounts directly to trim for ease of installation into existing 4" or recessed housings with medium base sockets • Provided with retention clips.

### LED Light Engine

LEDs are mounted directly to aluminum housing providing superior thermal management to ensure long life • Switchable white LED color temperature technology offers 2700K, 3000K, 3500K, 4000K, 5000K all in one trim • 90 CRI minimum • Accommodates 120 volts DC at 60Hz • Dimmable with most standard incandescent, magnetic low voltage and electronic low voltage dimmers • For a list of compatible dimmers, see JUNOESERIES-DIM.

### Electrical Connections

Trim features quick connect plug installed as standard for installation into LEDT24 housings with mating connector • Trim ships with a medium base socket adapter whip for installation into 4" incandescent housings with medium base sockets.

### Optical System

Diffused lens at end of mixing chamber to provide even light distribution for general illumination • 700L is equivalent to 65W BR30 lamp.

### Designer Color Finish Trim Inserts (sold separately)

Color Finish Trim inserts are accessory rings that attach to the 4BE/4SE module for a permanent finish. The finishes are available in Baffle or Smooth option:

- Black
- Brush Nickel
- Oil-Rubbed Bronze

### Life

Rated for 50,000 hours at 70% lumen maintenance.

### Labels

CSA certified to US and Canadian safety standards • ENERGY STAR® certified product • Suitable for wet location • Air-Loc certified in accordance with ASTM E283-2004 • NOM Certified • Can be used to comply with California Title 24 Part 6 High Efficacy LED light Source Requirements • T20 Certified.

### Testing

All reports are based on published industry procedures; field performance may differ from laboratory performance.

**Warranty** 5-year limited warranty. Complete warranty terms located at: [www.acuitybrands.com/CustomerResources/Terms\\_and\\_conditions.aspx](http://www.acuitybrands.com/CustomerResources/Terms_and_conditions.aspx)

Specifications subject to change without notice.

## PERFORMANCE DATA

	4BE/4SE
Input Voltage	120V
Input Power Typical	8.6W (+/-5%)
Power Factor	.9
Frequency	60 Hz
EMI/RFI	FCC Title 47, Part 15 Class B (consumer)
Minimum Starting Temp	-20°C (-4°F) minimum

**Note:** Actual performance may differ as a result of end-user environment and application. All values are design or typical values, measured under laboratory conditions at 25°C.

4BEMW SWW5 90CRI M6

LIGHTING PERFORMANCE DATA DONNÉES SUR LE RENDEMENT DE L'ÉCLAIRAGE	
Light Appearance (CCT) Aspect de la lumière (CCT)	
2700K soft white   blanc doux	
713 lumens   83 lumens per watt	
3000K warm white   blanc chaud	
717 lumens   83 lumens per watt	
3500K neutral white   blanc neutre	
722 lumens   84 lumens per watt	
4000K cool white   blanc froid	
723 lumens   84 lumens per watt	
5000K daylight   blanc neutre	
722 lumens   84 lumens per watt	
Watts	8.6
Color Accuracy (CRI) Précision des couleurs (CRI)	90



# E Series LED Downlight Retrofit

4" Switchable White LED Retrofit Module



## PHOTOMETRICS

Distribution Curve

Distribution Data

Output Data

Coefficient of Utilization

Illuminance Data at 30" Above Floor for a Single Luminaire

**4BEMW SWW5 90CRI, 2700K, Input Watts: 8.8, Delivered Lumens: 753, LPW: 85.6, S/MH: 1.15**

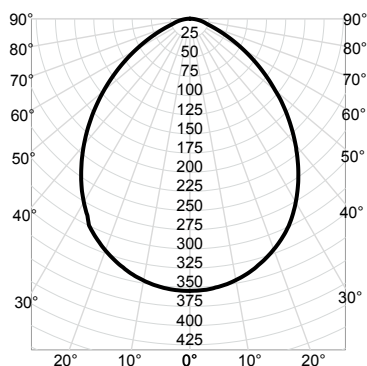

CP Summary	Zonal Lumen Summary				Coefficients of Utilization										Cone of Light			Luminance (cd/sq.m)	
	0°	Zone	Lumens	% Fixture	pf	80%		70%		50%		Mounting Height	Initial FC Center Beam	Beam Diameter	Average Luminance				
					pc	50%	30%	10%	50%	30%	10%	50%	30%	10%					
0°	355	0° - 30°	267	35%	0	119	119	119	116	116	116	110	110	110	6.0	9.9	12.2	0°	70,545
5°	353	0° - 40°	420	56%	1	106	103	99	104	101	98	99	97	94	8.0	5.5	16.3	45°	50,826
15°	335	0° - 60°	660	88%	2	95	89	84	93	87	83	89	84	81	10.0	3.5	20.3	55°	38,840
25°	301	0° - 90°	742	99%	3	84	77	72	83	76	71	80	74	70	12.0	2.5	24.4	65°	24,945
35°	247	90° - 180°	10	1%	4	76	68	62	75	67	62	72	66	61	14.0	1.8	28.4	75°	15,765
45°	181	0° - 180°	753	100%	5	69	60	54	67	60	54	65	59	53				85°	13,422
55°	112				6	62	54	48	61	54	48	59	53	47					
65°	53				7	57	49	43	56	48	43	54	48	43					
75°	21				8	52	44	39	51	44	39	50	43	38					
85°	6				9	48	40	35	48	40	35	46	40	35					
90°	0				10	45	37	32	44	37	32	43	36	32					

Beam Angle: 90.9°  
Field Angle: 137.8°

**4BEMW SWW5 90CRI, 3000K, Input Watts: 8.8, Delivered Lumens: 757, LPW: 86.0, S/MH: 1.17**

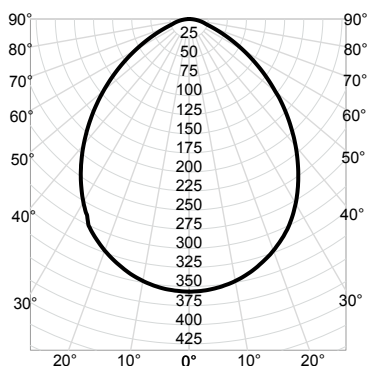

CP Summary	Zonal Lumen Summary				Coefficients of Utilization										Cone of Light			Luminance (cd/sq.m)	
	0°	Zone	Lumens	% Fixture	pf	80%		70%		50%		Mounting Height	Initial FC Center Beam	Beam Diameter	Average Luminance				
					pc	50%	30%	10%	50%	30%	10%	50%	30%	10%					
0°	357	0° - 30°	268	35%	0	119	119	119	116	116	116	110	110	110	6.0	9.9	12.2	0°	70,949
5°	354	0° - 40°	423	56%	1	106	103	99	104	101	98	99	97	94	8.0	5.6	16.3	45°	51,459
15°	337	0° - 60°	664	88%	2	95	89	84	93	87	83	89	84	81	10.0	3.6	20.3	55°	39,499
25°	304	0° - 90°	746	99%	3	84	77	72	83	76	71	80	74	70	12.0	2.5	24.4	65°	25,514
35°	249	90° - 180°	10	1%	4	76	68	62	75	67	62	72	66	61	14.0	1.8	28.5	75°	16,027
45°	183	0° - 180°	757	100%	5	69	60	54	67	60	54	65	59	53				85°	14,152
55°	114				6	62	54	48	61	54	48	59	53	47					
65°	54				7	57	49	43	56	48	43	54	48	43					
75°	21				8	52	44	39	51	44	39	50	43	38					
85°	6				9	48	40	35	48	40	35	46	40	35					
90°	0				10	45	37	32	44	37	32	43	36	32					

Beam Angle: 91.0°  
Field Angle: 138.1°

**4BEMW SWW5 90CRI, 3500K, Input Watts: 8.8, Delivered Lumens: 766, LPW: 87.0, S/MH: 1.17**

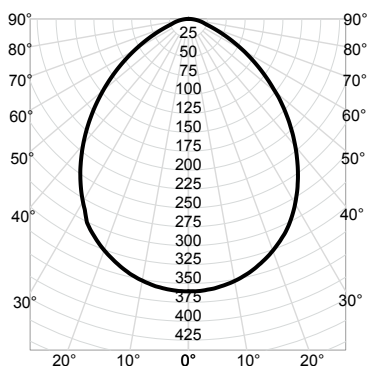

CP Summary	Zonal Lumen Summary				Coefficients of Utilization										Cone of Light			Luminance (cd/sq.m)	
	0°	Zone	Lumens	% Fixture	pf	80%		70%		50%		Mounting Height	Initial FC Center Beam	Beam Diameter	Average Luminance				
					pc	50%	30%	10%	50%	30%	10%	50%	30%	10%					
0°	360	0° - 30°	271	35%	0	119	119	119	116	116	116	110	110	110	6.0	10.0	12.2	0°	71,687
5°	359	0° - 40°	428	56%	1	106	103	99	104	101	98	99	97	94	8.0	5.6	16.3	45°	52,300
15°	341	0° - 60°	672	88%	2	95	89	84	93	87	83	89	84	81	10.0	3.6	20.4	55°	40,193
25°	308	0° - 90°	755	99%	3	84	77	72	83	76	71	80	74	69	12.0	2.5	24.4	65°	26,079
35°	253	90° - 180°	11	1%	4	76	68	62	74	67	62	72	66	61	14.0	1.8	28.5	75°	16,334
45°	186	0° - 180°	766	100%	5	69	60	54	67	60	54	65	58	53				85°	14,586
55°	116				6	62	54	48	61	54	48	59	53	47					
65°	55				7	57	49	43	56	48	43	54	48	43					
75°	21				8	52	44	39	51	44	39	50	43	38					
85°	6				9	48	40	35	47	40	35	46	40	35					
90°	0				10	45	37	32	44	37	32	43	36	32					

Beam Angle: 91.0°  
Field Angle: 137.5°



# E Series LED Downlight Retrofit

## 4" Switchable White LED Retrofit Module



### PHOTOMETRICS

Distribution Curve      Distribution Data      Output Data      Coefficient of Utilization      Illuminance Data at 30" Above Floor for a Single Luminaire

**4BEMW SWW5 90CRI, 4000K, Input Watts: 8.9, Delivered Lumens: 772, LPW: 86.7, S/MH: 1.17**

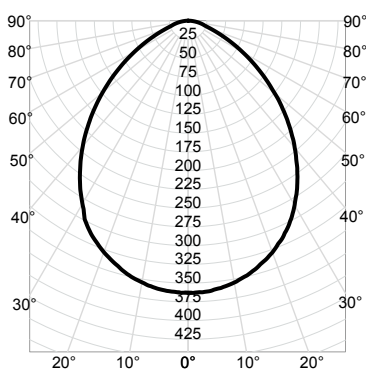

CP Summary	Zonal Lumen Summary				Coefficients of Utilization												Cone of Light			Luminance (cd/sq.m)	
	0°	Zone	Lumens	% Fixture	pw	80%				70%				50%				Mounting Height	Initial FC Center Beam	Beam Diameter	Average Luminance
						50%	30%	10%	50%	30%	10%	50%	30%	10%							
0°	363	0° - 30°	273	35%	0	119	119	119	116	116	116	110	110	110	6.0	10.1	12.2	0°	72,232		
5°	361	0° - 40°	431	56%	1	106	103	99	104	101	98	99	97	94	8.0	5.7	16.3	45°	52,640		
15°	344	0° - 60°	677	88%	2	95	89	84	93	87	83	89	84	81	10.0	3.6	20.4	55°	40,356		
25°	309	0° - 90°	761	99%	3	84	77	72	83	76	71	80	74	69	12.0	2.5	24.4	65°	26,168		
35°	254	90° - 180°	11	1%	4	76	68	62	74	67	62	72	66	61	14.0	1.9	28.5	75°	16,411		
45°	187	0° - 180°	772	100%	5	69	60	54	67	60	54	65	58	53				85°	14,517		
55°	116				6	62	54	48	61	54	48	59	53	47							
65°	56				7	57	49	43	56	48	43	54	48	43							
75°	21				8	52	44	39	51	44	39	50	43	38							
85°	6				9	48	40	35	47	40	35	46	40	35							
90°	0				10	45	37	32	44	37	32	43	36	32							

Beam Angle: 91.0°  
Field Angle: 138.6°

**4BEMW SWW5 90CRI, 5000K, Input Watts: 8.9, Delivered Lumens: 775, LPW: 87.1, S/MH: 1.17**

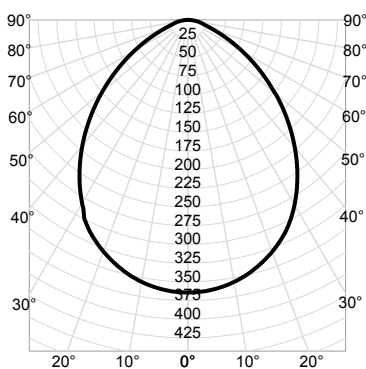

CP Summary	Zonal Lumen Summary				Coefficients of Utilization												Cone of Light			Luminance (cd/sq.m)	
	0°	Zone	Lumens	% Fixture	pw	80%				70%				50%				Mounting Height	Initial FC Center Beam	Beam Diameter	Average Luminance
						50%	30%	10%	50%	30%	10%	50%	30%	10%							
0°	364	0° - 30°	274	35%	0	119	119	119	116	116	116	110	110	110	6.0	10.1	12.2	0°	72,489		
5°	362	0° - 40°	432	56%	1	106	103	99	104	101	98	99	97	94	8.0	5.7	16.3	45°	52,868		
15°	345	0° - 60°	680	88%	2	95	89	84	93	87	83	89	84	81	10.0	3.6	20.4	55°	40,623		
25°	311	0° - 90°	765	99%	3	84	77	72	83	76	71	80	74	69	12.0	2.5	24.5	65°	26,319		
35°	255	90° - 180°	11	1%	4	76	68	62	74	67	62	72	66	61	14.0	1.9	28.5	75°	16,495		
45°	188	0° - 180°	775	100%	5	69	60	54	67	60	54	65	58	53				85°	14,586		
55°	117				6	62	54	48	61	54	48	59	53	47							
65°	56				7	57	49	43	56	48	43	54	47	42							
75°	21				8	52	44	39	51	44	39	50	43	38							
85°	6				9	48	40	35	47	40	35	46	40	35							
90°	0				10	45	37	32	44	37	32	43	36	32							

Beam Angle: 91.1°  
Field Angle: 140.1°