

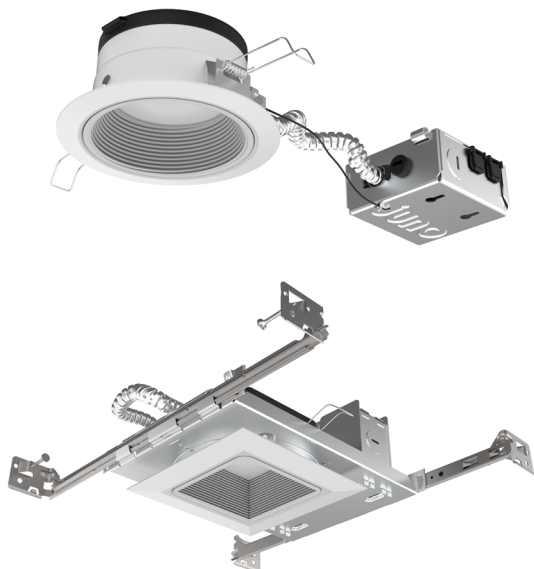

Podz™ LED Downlight Series

4" Canless Round and Square LED Downlight
New Construction or Remodel

JPDZ4 Series



Dimensions

4" Round

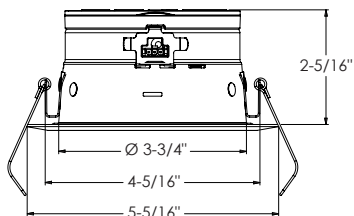

4" Square

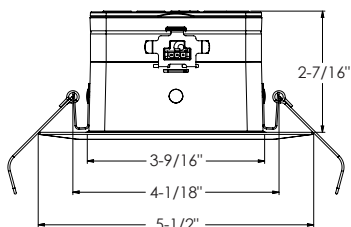

Application Flexibility - Remodel



Application Flexibility - New Construction



Project:
Fixture Type:
Location:
Contact/Phone:

Product Features

Canless low profile 4" LED recessed downlight with deeply regressed light source and technology rich features offers performance up to 1200L and installation solutions for both new construction and remodel applications.

Patent pending integral light engine

- Integrated design offers switchable LED color temperature and adjustable lumen output directly on module for easy switching
- Advanced color mixing technology provides consistent color rendering on the black body curve at all LED color temperatures while maintaining a high 90+ CRI
- WarmDim™ setting provides performance similar to incandescent light sources and warms the LED color temperature over the dimming range from 2850K to 1900K

Installation flexibility and ease

- Low profile integrated LED downlight less than 3" in height fits virtually anywhere
- Installs directly into the plenum - eliminates need for typical recessed housing
- Installs into new construction or remodel applications

Applications

- Ideal for a breadth of residential and commercial applications
- Shallow plenum installations
- IC rated - for direct contact with insulation
- Wet location listed - for use in shower applications

Performance

Switchable Delivered Lumens	700L, 1000L, 1200L
Switchable LED Color Temperature	27K, 30K, 35K, 40K, 50K
WarmDim Included as standard	2850K - 1900K over dimming range
CRI	90+
Voltage	Dedicated 120V or MVOLT (120-277V)
Dimming	Forward/Reverse Phase or 0-10V



Podz™ LED Downlight Series

4" Canless Round and Square LED Downlight
New Construction or Remodel

ORDERING INFORMATION

For complete fixture, order trim module + mounting option

Podz TRIM MODULE

Example: JPDZ4 DC ALO10 SWW5WD 90CRI JPDZRMJBX 120 FRPC WWH

Series	Trim Type	Lumens	Color Temperature	CRI
JPDZ4 Juno Podz 4" LED Downlights	DB Round Downlight Baffle DC Round Downlight Cone SQDB Square Downlight Baffle SQDC Square Downlight Reflector	ALO10 Adjustable Lumen Output 700L, 1000L, and 1200L	SWW5WD Switchable White 2700K, 3000K, 3500K, 4000K, 5000K, + WarmDim (2850K-1900K)	90CRI 90+CRI

Mounting Options	Voltage/Driver	Finish
REMODEL: JPDZRMJBX 4 Juno Podz universal remodel junction box (for 4", 5", 6")	120 FRPC 120V Forward/Reverse Phase Cut, 5% dim MVOLT ZT10 Multi-Volt (120-277), 0-10V, 10% dim	WWH 1 White, White Trim Ring BWH 2 Black, White Trim Ring CWH 3 Clear, White Trim Ring HZWH 3 Haze, White Trim Ring WHZWH 3 Wheat Haze, White Trim Ring
NEW CONSTRUCTION: JPDZ4RDNCMF Juno Podz 4IN Round New Construction Mounting Frame JPDZ4SQNCMF Juno Podz 4IN Square New Construction Mounting Frame		

Square trim options available to order July 2021.

NOTES

- 1 WWH is only available with DB, SQDB, DC and SQDC.
- 2 BWH only available with DB and SQDB.
- 3 CWH, HZWH and WHZWH only available with DC and SQDC.
- 4 Not for use in an existing housing.

Product ships in two parts

Trim Module



Mounting Option

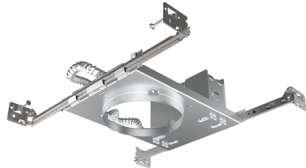

Remodel - Round

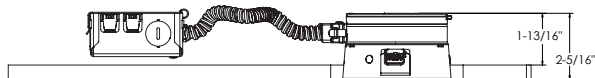

4 1/2" CEILING CUTOUT

Remodel - Square

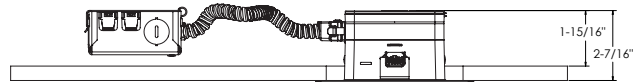

4 3/4" CEILING CUTOUT

New Construction - Round

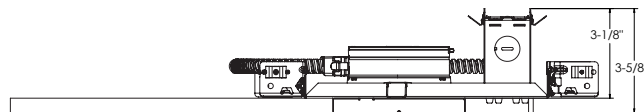

4 1/2" CEILING CUTOUT

New Construction - Square

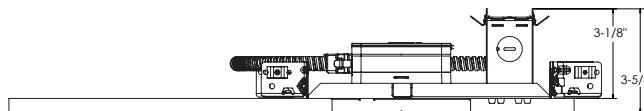

4 3/4" CEILING CUTOUT

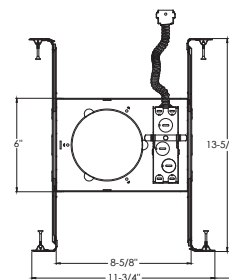
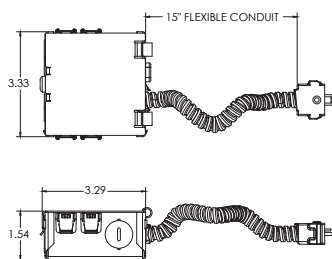



Podz™ LED Downlight Series

4" Canless Round and Square LED Downlight
New Construction or Remodel

Specifications

LED Light Engine

Patent pending integral light engine mounts directly to aluminum housing providing superior heat transfer to ensure long life of the electronics

- Switchable LED color temperature and adjustable lumen output directly on module for easy switching
- Advanced color mixing technology provides consistent color rendering on the black body curve at all LED color temperatures
- LED color temperature settings include 2700K, 3000K, 3500K, 4000K and 5000K; factory set at 3000K
- Three lumen switching options include 700L, 1000L and 1200L; factory set at 1000L
- Dedicated WarmDim setting provides performance similar to incandescent light sources and warms the LED color temperature over the dimming range from 2850K to 1900K
- 90CRI minimum

LED Driver

Choice of dedicated 120 volt (120) driver or universal voltage (MVOLT) drivers that accommodate input voltages from 120-277 volts AC at 50/60Hz

- Power factor > 0.9 at 120V input
- 120 volt only driver is dimmable with the use of most incandescent, magnetic low voltage and electronic low voltage wall box dimmers
- Universal voltage drivers are dimmable with the use of most 0-10V wall box dimmers
- For a list of compatible dimmers, see [JUNOICLED-DIM](#)

Optical System

Computer-optimized reflector design with high reflectance white finish coupled with a high transmission diffusing lens conceals the LEDs and produces uniform aperture luminance

- Deep regression of lens produces a low glare, efficient system typical of a standard 4" downlight medium flood distribution providing even illumination for general downlighting applications.

Certifications

ENERGY STAR® Certified • Can be used to comply with 2019 Title 24, Part 6, JA8 high efficacy LED light source requirements

- UL listed for U.S. and Canada through-branch wiring, damp locations and for wet location (indoor covered ceiling)
- UL and cUL

Testing All reports are based on published industry procedures; field performance may differ from laboratory performance.

Trim Module Construction

Low profile, < 3" aluminum housing with integral white flange

- Designed for installation directly into the plenum in IC (insulated ceiling) or non-IC construction
- Provided with spring clips for ease of installation
- Accommodates up to a 1 1/2" ceiling thickness

Trim Finishes

Choice of baffle or cone trims in a selection of finishes ship installed in trim

Remodel Junction Box Construction

22-gauge die-formed galvanized steel junction box

- Conduit cable with quick connect electrical plug pre-wired on junction box and allows for easy electrical connection with the trim module
- Junction box provided with (5) 1/2" and (1) 3/4" knockouts, (4) integrated wire traps for 12/2 or 12/3 NM cable UL listed and cUL listed for through-branch wiring, maximum of 4 #12 branch circuit

New Construction Mounting Frame

22-gauge die-formed galvanized steel mounting frame

- Rough-in section (junction box, mounting frame and bar hangers) fully assembled for ease of installation
- Pre-installed Air-Loc gasket applied to frame
- Conduit cable with quick connect electrical plug pre-wired on junction box and allows for easy electrical connection with the trim module
- Junction box provided with (5) 1/2" and (1) 3/4" knockouts, (4) knockouts for 12/2 or 12/3 NM cable and ground wire
- UL listed and cUL listed for through-branch wiring, maximum of 6 #12 branch circuit conductors
- Junction box provided with removable access plates
- Knock-outs equipped with pryout slots

Includes Patented (US Patent D552,969) Real Nail® 3 bar hangers: telescoping system permits quick placement of housing any where within 24" O.C. joists or suspended ceilings

- Includes removable nail for repositioning of fixture in wood joist construction
- Integral T-bar notch and clip for suspended ceilings.

LED housing is designed to provide 50,000 hours of life

- 5 year limited warranty on LED components.

Note: Actual performance may differ as a result of end-user environment and application.

All values are design or typical values, measured under laboratory conditions at 25 °C.

Specifications subject to change without notice.

ELECTRICAL DATA

Dedicated 120V Only Driver Option (120 FRPC)

	700L	1000L	1200L
Input Power	8.1W (+/-5%)	13.6W (+/-5%)	15W (+/-5%)
Input Current	0.07A	0.11A	0.13A
Frequency	50/60Hz	50/60Hz	50/60Hz
EMI/RFI	FCC Title 47 CFR, Part 15, Class B (residential)	FCC Title 47 CFR, Part 15, Class B (residential)	FCC Title 47 CFR, Part 15, Class B (residential)
Minimum starting temp	-20°C	-20°C	-20°C

ELECTRICAL DATA

Universal Voltage

MVOLT ZT10

	700L		1000L		1200L	
	120V	277V	120V	277V	120V	277V
Input Power	8.1W (+/-5%)	8.1W (+/-5%)	13.6W (+/-5%)	13.6W (+/-5%)	15W (+/-5%)	15W (+/-5%)
Input Current	0.07A	0.03A	0.11A	0.05A	0.13A	0.06A
Frequency	50/60Hz	50/60Hz	50/60Hz	50/60Hz	50/60Hz	50/60Hz
EMI/RFI	FCC Title 47 CFR, Part 15, Class B (residential)	FCC Title 47 CFR, Part 15, Class B (residential)	FCC Title 47 CFR, Part 15, Class B (residential)	FCC Title 47 CFR, Part 15, Class B (residential)	FCC Title 47 CFR, Part 15, Class B (residential)	FCC Title 47 CFR, Part 15, Class B (residential)
Minimum starting temp	-20°C	-20°C	-20°C	-20°C	-20°C	-20°C



Podz™ LED Downlight Series

4" Canless Round and Square LED Downlight
New Construction or Remodel

PHOTOMETRICS

Distribution Curve

Distribution Data

Output Data

Coefficient of Utilization

Illuminance Data at 30" Above
Floor for a Single Luminaire

JPDZ4 DB 07LM 30K 90CRI WWH, Input Watts: 8.1, Delivered Lumens: 672, LPW: 83.0, S/MH: 1.11, Test No: 20-973-1

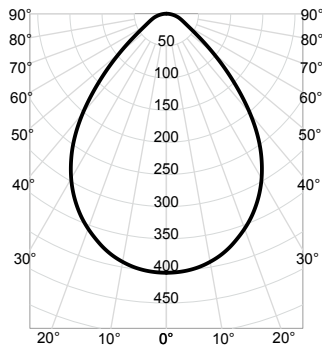

CP Summary		Zonal Lumen Summary		Coefficients of Utilization						Cone of Light			Luminance (cd/sq.m)		
0°	Zone	Lumens	% Fixture	pf	80%		70%		50%		Mounting Height	Initial FC Center Beam	Beam Diameter	Average Luminance	
				pc	50%	30%	10%	50%	30%	10%					
0°	0° - 30°	295	44%	0	119	119	119	116	116	116	111	111	111	111	0° 65,673
5°	0° - 40°	452	67%	1	108	104	101	105	102	100	101	99	97	8.0 6.3 13.5 45° 33,417	
15°	0° - 60°	619	92%	2	97	92	87	95	90	86	92	88	84	10.0 4.0 16.8 55° 16,678	
25°	0° - 90°	672	100%	3	88	81	76	86	80	75	84	78	74	12.0 2.8 20.2 65° 11,259	
35°	90° - 180°	0	0%	4	80	73	67	79	72	67	76	71	66	14.0 2.1 23.6 75° 10,515	
45°	0° - 180°	672	100%	5	73	65	60	72	65	60	70	64	59	85° 8,975	
55°		59		6	67	59	54	66	59	54	64	58	53	Beam Angle: 80.2°	
65°		29		7	62	54	49	61	54	49	59	53	48	Field Angle: 119.3°	
75°		17		8	57	50	44	56	49	44	55	49	44		
85°		5		9	53	46	41	52	45	41	51	45	41		
90°		0		10	49	42	38	49	42	37	48	42	37		

JPDZ4 DB 10LM 30K 90CRI WWH, Input Watts: 13.6, Delivered Lumens: 1028, LPW: 75.6, S/MH: 1.12, Test No: 20-973-2

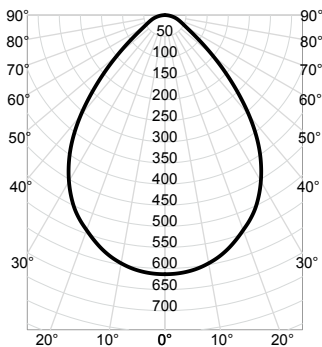

CP Summary		Zonal Lumen Summary		Coefficients of Utilization						Cone of Light			Luminance (cd/sq.m)	
0°	Zone	Lumens	% Fixture	pf	80%		70%		50%		Mounting Height	Initial FC Center Beam	Beam Diameter	Average Luminance
				pc	50%	30%	10%	50%	30%	10%				
0°	0° - 30°	451	44%	0	119	119	119	116	116	116	111	111	111	0° 99,993
5°	0° - 40°	692	67%	1	108	104	101	105	102	100	101	99	97	8.0 9.6 13.5 45° 51,301
15°	0° - 60°	948	92%	2	97	92	87	95	90	86	92	88	84	10.0 6.1 16.9 55° 25,656
25°	0° - 90°	1,028	100%	3	88	81	76	86	80	75	84	78	74	12.0 4.3 20.3 65° 17,198
35°	90° - 180°	0	0%	4	80	73	67	79	72	67	76	71	66	14.0 3.1 23.7 75° 16,056
45°	0° - 180°	1,028	100%	5	73	65	60	72	65	60	70	64	59	85° 13,649
55°		90		6	67	59	54	66	59	54	64	58	53	Beam Angle: 80.4°
65°		45		7	62	54	49	61	54	49	59	53	48	Field Angle: 119.4°
75°		26		8	57	50	44	56	49	44	55	49	44	
85°		7		9	53	46	41	52	45	41	51	45	40	
90°		0		10	49	42	37	49	42	37	48	42	37	

JPDZ4 DB 12LM 30K 90CRI WWH, Input Watts: 15.0, Delivered Lumens: 1116, LPW: 74.4, S/MH: 1.12, Test No: 20-973-3

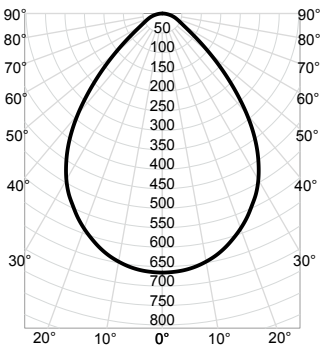

CP Summary		Zonal Lumen Summary		Coefficients of Utilization						Cone of Light			Luminance (cd/sq.m)	
0°	Zone	Lumens	% Fixture	pf	80%		70%		50%		Mounting Height	Initial FC Center Beam	Beam Diameter	Average Luminance
				pc	50%	30%	10%	50%	30%	10%				
0°	0° - 30°	488	44%	0	119	119	119	116	116	116	111	111	111	0° 108,434
5°	0° - 40°	750	67%	1	108	104	101	105	102	100	101	99	97	8.0 10.4 13.5 45° 55,818
15°	0° - 60°	1,029	92%	2	97	92	87	95	90	86	92	88	84	10.0 6.7 16.9 55° 27,928
25°	0° - 90°	1,116	100%	3	88	81	76	86	80	75	84	78	74	12.0 4.6 20.3 65° 18,702
35°	90° - 180°	0	0%	4	80	73	67	79	72	67	76	70	66	14.0 3.4 23.7 75° 17,441
45°	0° - 180°	1,116	100%	5	73	65	60	72	65	60	70	64	59	85° 14,771
55°		98		6	67	59	54	66	59	54	64	58	53	Beam Angle: 80.5°
65°		49		7	62	54	49	61	54	49	59	53	48	Field Angle: 119.5°
75°		28		8	57	50	44	56	49	44	55	49	44	
85°		8		9	53	46	41	52	45	41	51	45	40	
90°		0		10	49	42	37	49	42	37	48	42	37	



Podz™ LED Downlight Series

4" Canless Round and Square LED Downlight
New Construction or Remodel

PHOTOMETRICS

Distribution Curve

Distribution Data

Output Data

Coefficient of Utilization

Illuminance Data at 30" Above
Floor for a Single Luminaire

JPDZ4 DC 07LM 30K 90CRI HZWH, Input Watts: 8.1, Delivered Lumens: 699, LPW: 86.3, S/MH: 1.07, Test No: 20-973-4

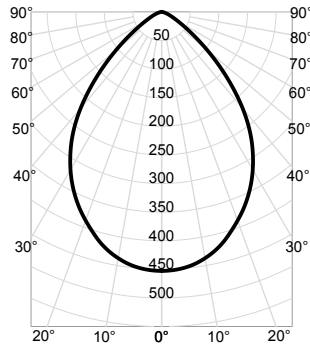

CP Summary				Zonal Lumen Summary				Coefficients of Utilization						Cone of Light			Luminance (cd/sq.m)	
0°	Zone	Lumens	% Fixture	pf	80%		20%		50%		Mounting Height	Initial FC Center Beam	Beam Diameter	Average Luminance				
				pc	50%	30%	10%	50%	30%	10%				50%	30%	10%	0°	45°
0°	0° - 30°	323	46%	0	119	119	119	116	116	111	111	111	6.0	12.6	9.9	0°	73,789	
5°	0° - 40°	493	70%	1	109	106	103	106	104	101	102	100	8.0	7.1	13.2	45°	36,874	
15°	0° - 60°	672	96%	2	99	94	89	97	92	88	94	90	10.0	4.5	16.5	55°	17,047	
25°	0° - 90°	699	100%	3	90	84	79	88	83	78	86	81	12.0	3.1	19.8	65°	7,404	
35°	90° - 180°	0	0%	4	82	75	70	81	74	69	78	73	14.0	2.3	23.1	75°	3,463	
45°	0° - 180°	699	100%	5	75	68	62	74	67	62	72	66				85°	1,309	
55°		60		6	69	62	56	68	61	56	66	60	Beam Angle: 78.9°					
65°		19		7	63	56	51	63	56	51	61	55	Field Angle: 114.9°					
75°		6		8	59	52	47	58	51	46	57	51						
85°		1		9	55	47	43	54	47	43	53	47						
90°		0		10	51	44	39	50	44	39	49	43						

JPDZ4 DC 10LM 30K 90CRI HZWH, Input Watts: 13.6, Delivered Lumens: 1070, LPW: 78.7, S/MH: 1.07, Test No: 20-973-5

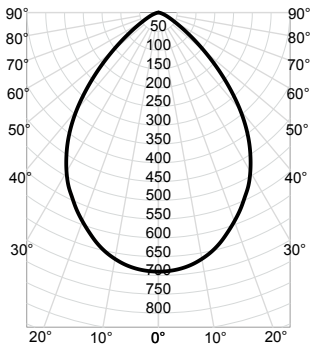

CP Summary				Zonal Lumen Summary				Coefficients of Utilization						Cone of Light			Luminance (cd/sq.m)	
0°	Zone	Lumens	% Fixture	pf	80%		20%		50%		Mounting Height	Initial FC Center Beam	Beam Diameter	Average Luminance				
				pc	50%	30%	10%	50%	30%	10%				50%	30%	10%	0°	45°
0°	0° - 30°	493	46%	0	119	119	119	116	116	111	111	111	6.0	19.2	9.9	0°	112,427	
5°	0° - 40°	754	70%	1	109	106	103	106	104	101	102	100	8.0	10.8	13.2	45°	56,624	
15°	0° - 60°	1,029	96%	2	99	94	89	97	92	88	94	90	10.0	6.9	16.6	55°	26,224	
25°	0° - 90°	1,070	100%	3	90	84	79	88	83	78	85	81	12.0	4.8	19.9	65°	11,298	
35°	90° - 180°	0	0%	4	82	75	70	81	74	69	78	73	14.0	3.5	23.2	75°	5,289	
45°	0° - 180°	1,070	100%	5	75	68	62	74	67	62	72	66				85°	2,057	
55°		92		6	69	61	56	68	61	56	66	60	Beam Angle: 79.3°					
65°		29		7	63	56	51	63	56	51	61	55	Field Angle: 114.9°					
75°		8		8	59	51	46	58	51	46	57	51						
85°		1		9	54	47	43	54	47	43	53	47						
90°		0		10	51	44	39	50	44	39	49	43						

JPDZ4 DC 12LM 30K 90CRI HZWH, Input Watts: 15.0, Delivered Lumens: 1149, LPW: 76.6, S/MH: 1.07, Test No: 20-973-6

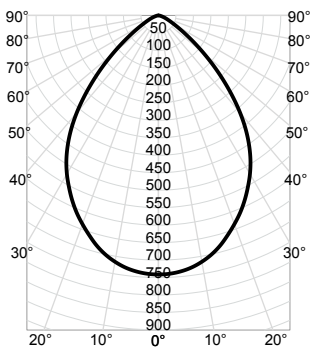

CP Summary				Zonal Lumen Summary				Coefficients of Utilization						Cone of Light			Luminance (cd/sq.m)	
0°	Zone	Lumens	% Fixture	pf	80%		20%		50%		Mounting Height	Initial FC Center Beam	Beam Diameter	Average Luminance				
				pc	50%	30%	10%	50%	30%	10%				50%	30%	10%	0°	45°
0°	0° - 30°	529	46%	0	119	119	119	116	116	111	111	111	6.0	20.6	9.9	0°	120,819	
5°	0° - 40°	809	70%	1	109	106	103	106	104	101	102	100	8.0	11.6	13.2	45°	60,796	
15°	0° - 60°	1,104	96%	2	99	94	89	97	92	88	94	90	10.0	7.4	16.6	55°	28,127	
25°	0° - 90°	1,149	100%	3	90	84	79	88	83	78	86	81	12.0	5.1	19.9	65°	12,146	
35°	90° - 180°	0	0%	4	82	75	70	81	74	69	78	73	14.0	3.8	23.2	75°	5,667	
45°	0° - 180°	1,149	100%	5	75	68	62	74	67	62	72	66				85°	2,244	
55°		99		6	69	61	56	68	61	56	66	60	Beam Angle: 79.2°					
65°		32		7	63	56	51	63	56	51	61	55	Field Angle: 114.9°					
75°		9		8	59	51	46	58	51	46	57	51						
85°		1		9	54	47	43	54	47	43	53	47						
90°		0		10	51	44	39	50	44	39	49	43						

4" LUMEN OUTPUT MULTIPLIERS

CCT	DB WWH	DB BWH	DC WWH	DC CWH	DC WHZWH	DC HZWH
2700K	1.01	0.78	1.07	1.11	1.03	1.01
3000K	1.00	0.77	1.06	1.09	1.01	1.00
3500K	1.00	0.77	1.07	1.10	1.02	1.00
4000K	1.01	0.78	1.07	1.11	1.02	1.01
5000K	1.00	0.77	1.06	1.09	1.01	1.00
Warm Dim	0.92	0.71	0.98	1.01	0.93	0.92