

# AR back boxes and accessories for 20A, 30A and 60A receptacle housings

## Ordering information:

### ARE

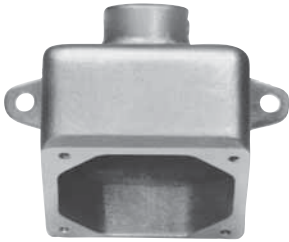

Hub size	Cat. # 20A / 30A	Cat. # 60A
1/2"	ARE13	
3/4"	ARE23	
1"	ARE33	ARE36
1 1/4"		ARE46
1 1/2"		ARE56

### ARRC

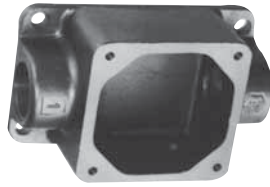

Hub size	Cat. # 20A / 30A	Cat. # 60A
1/2"	ARRC13	
3/4"	ARRC23	
1"	ARRC33	ARRC36
1 1/4"		ARRC46
1 1/2"		ARRC56

### AR 15° angle adapter



For ARRH and ARRC back boxes

For steel panel or cabinet

Mounts on	Takes AR receptacle housings	Cat. #
ARRH and ARRC back boxes	20A and 30A	AR30
ARRH and ARRC back boxes	60A	AR60
Steel panel or cabinet	60A, 100A and 150A	AR610

### ARRH



Hub size	Cat. # 20A / 30A	Cat. # 60A
1/2"	ARRH13	
3/4"	ARRH23	
1"	ARRH33	ARRH36
1 1/4"		ARRH46
1 1/2"		ARRH56

### ARD



Hub size	Cat. # 20A / 30A	Cat. # 60A
1/2"	ARD13	
3/4"	ARD23	
1"	ARD33	ARD36
1 1/4"		ARD46
1 1/2"		ARD56

### Spring door assembly



Used with	Cat. #
30A; 2-, 3-, 4-pole	QE50
60A; 2-, 3-pole	QE51
60A; 4-pole	QE52
100A and 150A; 2-, 3-pole	QE53
100A and 150A; 4-pole	QE54

### ARJ



Hub size	Cat. # 20A / 30A	Cat. # 60A
1/2"	ARJ13	
3/4"	ARJ23	
1"	ARJ33	ARJ36
1 1/4"		ARJ46
1 1/2"		ARJ56

### ARJG

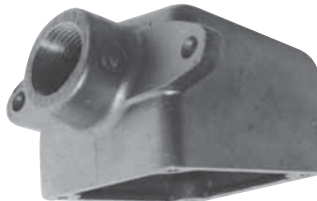

Hub size	Cat. # 20A / 30A	Cat. # 60A
1/2"	ARJG13	
3/4"	ARJG23	
1"	ARJG33	ARJG36
1 1/4"		ARJG46
1 1/2"		ARJG56

### Cap and chain



Used with	Cat. #
30A; 2-, 3-, 4-pole	QE13
60A; 2-, 3-pole	QE32
60A; 4-pole	QE34
100A and 150A; 2-, 3-pole	QE62
100A and 150A; 4-pole	QE64

# AJ and AJC back boxes with angle adapters for 60A, 100A, 200A and 400A receptacle housings; AJX assemblies for 200A and 400A receptacle housings



AJ back box with 60A/100A/150A angle adapter



AJ back box with 200A/400A angle adapter

## AJX assemblies (Back box with angle adapter, 3 blank plates and 1 hub plate)



Hub size	Cat. # 400A
2"	AJX69
2 1/2"	AJX79
3"	AJX89
3 1/2"	AJX929
4"	AJX9210
5"	AJX9212

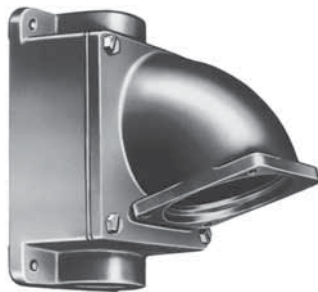

AJC back box with 60A/100A/150A AJA angle adapter



AJC back box with 200A angle adapter

## AJX component parts

For use in making assemblies with arrangements of hub plates (4 required) other than those listed.

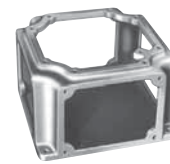

Back box



Angle adapter

## Ordering information:

### AJ and AJC back boxes

Hub size	Type	60A, 100A, 150A		200A		400A	
		Cat. # Box only	Cat. # Box and adapter assembly	Cat. # Box only	Cat. # Box and adapter assembly	Cat. # Box only	Cat. # Box and adapter assembly
1"	One hub	AJ46 <sup>B</sup>	AJ37				
	Through feed	AJC56 <sup>B</sup>	AJC37				
1 1/4"	One hub	AJ46	AJ47				
	Through feed	AJC56 <sup>B</sup>	AJC47				
1 1/2"	One hub	AJ56	AJ57	AJ71 <sup>B</sup>	AJ58		
	Through feed	AJC56 <sup>B</sup>	AJC57				
2"	One hub	AJ66	AJ67	AJ71 <sup>B</sup>	AJ68	AJ82 <sup>B</sup>	AJ69 <sup>C</sup>
	Through feed	AJC66	AJC67				
2 1/2"	One hub			AJ71 <sup>B</sup>	AJ78	AJ82 <sup>B</sup>	AJ79 <sup>C</sup>
	Through feed			AJC71	AJC78		
3"	One hub					AJ82 <sup>B</sup>	AJ89 <sup>C</sup>
	Through feed						
Angle adapter		AJA6		AJA1		AJA2	

Type	Cat. #
Back box 400A	AJX99
Angle adapter 400A	AJ245



Hub plate



Blank plate

Hub size	Cat. # Hub plate 400A	Cat. # Blank plate 400A
2"	YYP96	YYP900
2 1/2"	YYP97	
3"	YYP98	
3 1/2"	YYP99	
4"	YYP910	
5"	YYP9012	

Description	Cat. #
Hub plate replacement gasket (for all hub plates shown above)	GASK1041

<sup>A</sup> AJ and AJC back boxes are square, making it possible to install with hub in several positions.

<sup>B</sup> Reducer supplied with assembly.

<sup>C</sup> Use AJ69, AJ79 or AJ89 for cables up to 2 - #350MCM, 3 - #300MCM or 4 - #250MCM. For larger cables, use AJX69, etc., listed under assemblies.

## Dimensions

### Dimensions (in inches):

#### ARE back boxes

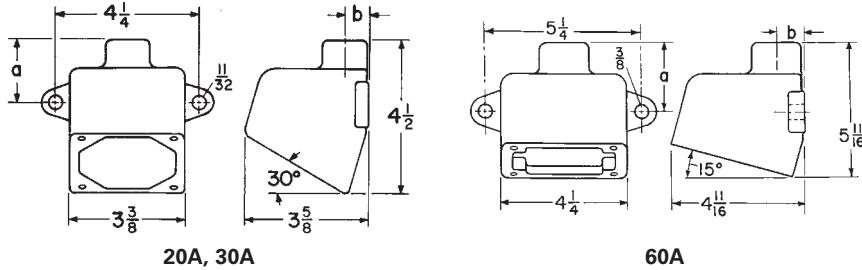

Cat. #	Amperage	Hub size	a	b
13	20A, 30A	1/2"	1 <sup>21</sup> / <sub>32</sub>	1 <sup>11</sup> / <sub>16</sub>
23	20A, 30A	3/4"	1 <sup>27</sup> / <sub>32</sub>	1 <sup>13</sup> / <sub>16</sub>
33	20A, 30A	1"	1 <sup>31</sup> / <sub>32</sub>	1 <sup>15</sup> / <sub>16</sub>
36	60A	1"	2 <sup>9</sup> / <sub>16</sub>	1 <sup>15</sup> / <sub>16</sub>
46	60A	1 1/4"	2 <sup>5</sup> / <sub>8</sub>	1 <sup>3</sup> / <sub>16</sub>
56	60A	1 1/2"	2 <sup>1</sup> / <sub>16</sub>	1 <sup>5</sup> / <sub>16</sub>

#### AJX back body – 400A

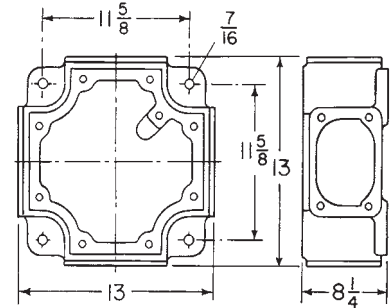

#### Hub plate – 400A

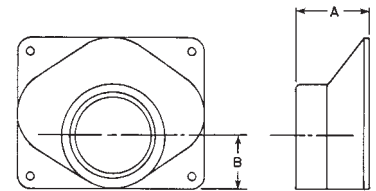

Cat. #	Hub size	A	B
YYP96	2"	3/4	1 <sup>11</sup> / <sub>16</sub>
YYP97	2 1/2"	3/8	2 <sup>5</sup> / <sub>16</sub>
YYP98	3"	3/8	2 <sup>7</sup> / <sub>16</sub>
YYP99	3 1/2"	3/8	2 <sup>9</sup> / <sub>16</sub>
YYP910	4"	3/8	2 <sup>13</sup> / <sub>16</sub>
YYP9012	5"	4 <sup>5</sup> / <sub>8</sub>	3 <sup>1</sup> / <sub>16</sub>

#### ARJG back boxes

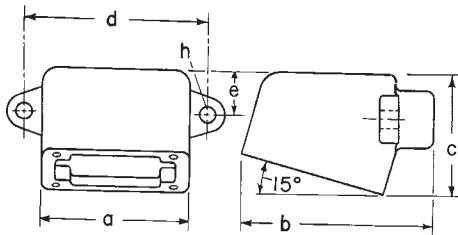

Cat. #	Amperage	Hub size	a	b	c	d	e	h (dia.)
13	20A, 30A	1/2"	3 <sup>7</sup> / <sub>8</sub>	4 <sup>15</sup> / <sub>32</sub>	2 <sup>3</sup> / <sub>4</sub>	4 <sup>1</sup> / <sub>4</sub>	1 <sup>3</sup> / <sub>8</sub>	1 <sup>11</sup> / <sub>32</sub>
23	20A, 30A	3/4"	3 <sup>7</sup> / <sub>8</sub>	4 <sup>15</sup> / <sub>32</sub>	2 <sup>3</sup> / <sub>4</sub>	4 <sup>1</sup> / <sub>4</sub>	1 <sup>3</sup> / <sub>8</sub>	1 <sup>11</sup> / <sub>32</sub>
33	20A, 30A	1"	3 <sup>7</sup> / <sub>8</sub>	4 <sup>19</sup> / <sub>32</sub>	2 <sup>3</sup> / <sub>4</sub>	4 <sup>1</sup> / <sub>4</sub>	1 <sup>3</sup> / <sub>8</sub>	1 <sup>11</sup> / <sub>32</sub>
36	60A	1"	4 <sup>1</sup> / <sub>4</sub>	5 <sup>5</sup> / <sub>8</sub>	4 <sup>1</sup> / <sub>16</sub>	5 <sup>1</sup> / <sub>4</sub>	1 <sup>5</sup> / <sub>8</sub>	3 <sup>3</sup> / <sub>8</sub>
46	60A	1 1/4"	4 <sup>1</sup> / <sub>4</sub>	5 <sup>11</sup> / <sub>16</sub>	4 <sup>11</sup> / <sub>16</sub>	5 <sup>1</sup> / <sub>4</sub>	1 <sup>5</sup> / <sub>8</sub>	3 <sup>3</sup> / <sub>8</sub>
56	60A	1 1/2"	4 <sup>1</sup> / <sub>4</sub>	5 <sup>3</sup> / <sub>4</sub>	4 <sup>1</sup> / <sub>16</sub>	5 <sup>1</sup> / <sub>4</sub>	1 <sup>5</sup> / <sub>8</sub>	3 <sup>3</sup> / <sub>8</sub>

#### AJ and AJC back boxes

(With 60A, 100A, 150A, 200A and 400A angle adapters)

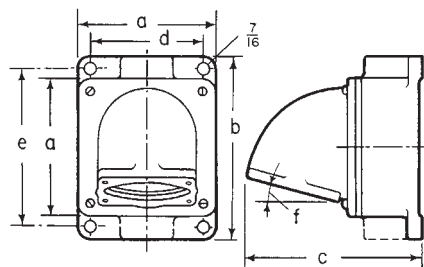

Cat. #	Amperage	Hub size	a	b	c	d	e	f
37, 47, 57	60A, 100A	1", 1 1/4", 1 1/2"	5/8	8	7 <sup>7</sup> / <sub>16</sub>	4 <sup>1</sup> / <sub>8</sub>	7	15°
67	60A, 100A	2"	5/8	8	8	4 <sup>1</sup> / <sub>8</sub>	7	15°
58, 68, 78	200A	1 1/2", 2", 2 1/2"	8	10 <sup>3</sup> / <sub>4</sub>	9 <sup>7</sup> / <sub>8</sub>	6 <sup>3</sup> / <sub>4</sub>	9 <sup>1</sup> / <sub>2</sub>	45°
69, 79, 89	400A	2", 2 1/2", 3"	9	11 <sup>5</sup> / <sub>8</sub>	11 <sup>13</sup> / <sub>16</sub>	7 <sup>3</sup> / <sub>4</sub>	10 <sup>3</sup> / <sub>8</sub>	45°

#### AJ angle adapter

