

# Condulet FS and FD single-gang device boxes – cast iron or aluminum

See pages 39-47 for accessories

With and without mounting lugs for threaded rigid and IMC conduit

## Applications:

Cast device boxes are installed to:

- Accommodate wiring devices
- Act as pull boxes for conductors in a conduit system
- Provide openings to make splices and taps in conductors
- Provide access to conductors for maintenance and future system changes
- Connect conduit sections
- FSY boxes for mounting surface devices on floor or bench (used with single gang covers)

## Features:

- Internal green ground screw standard on boxes
- Suitable for use in wet locations when used with gasketed covers
- Mounting lugs standard on most boxes
- Tapered threaded hubs (NPT) with integral bushing
- Available for surface mounting (with mounting lugs) or flush mounting (without mounting lugs) as listed
- Available as shallow (FS) or deep (FD) configuration; use FD if device to be enclosed exceeds 1 5/8" in depth
- Ample wiring room provided in either FS or FD configuration
- Wide selection of surface or flush covers available in three materials (sheet steel, Feraloy, aluminum)
- Covers for flush mounting extend to conceal the rough plaster line
- Available in single gang and multi-gang configurations with hubs, and as blank bodies for drilled and tapped openings

## Certifications and compliances:

- UL standard: 514A
- ANSI standard: C33.84
- Fed. Spec.: W-C-5860
- CSA standard: C22.2 No. 18

## Standard materials:

- Feraloy iron alloy or copper-free aluminum

## Standard finishes:

- Feraloy – electrogalvanized and aluminum acrylic paint
- Aluminum – natural

## Options:

Description	Suffix
• Corro-free epoxy powder coat, external.....	<b>S752</b>
• Corro-free epoxy powder coat, internal and external.....	<b>S753</b>
• Hot dip galvanized .....	<b>HDG</b>

## Size ranges:

- Hubs – 1/2" to 1"

## Ordering information:

### FS/FD<sup>ⓐ</sup>



Hub size	Cat. #	Cat. #
1/2"	<b>FS1<sup>ⓐ</sup></b>	<b>FD1<sup>ⓐ</sup></b>
3/4"	<b>FS2<sup>ⓐ</sup></b>	<b>FD2<sup>ⓐ</sup></b>
1"	<b>FS3<sup>ⓐ</sup></b>	<b>FD3<sup>ⓐ</sup></b>

### FSL/FDL



Hub size	Cat. #	Cat. #
1/2"	<b>FSL1</b>	<b>FDL1</b>
3/4"	<b>FSL2</b>	<b>FDL2</b>

### FSR/FDR

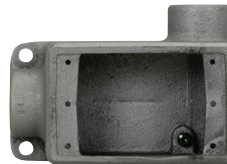

Hub size	Cat. #	Cat. #
1/2"	<b>FSR1</b>	<b>FDR1</b>
3/4"	<b>FSR2</b>	<b>FDR2</b>

### Die cast aluminum<sup>ⓐ</sup>



Hub size	Cat. #	Cat. #
1/2"	<b>FS1 SA</b>	<b>FSC1 SA</b>
3/4"	<b>FS2 SA</b>	<b>FSC2 SA</b>

### FSC/FDC<sup>ⓐ</sup>



Hub size	Cat. #	Cat. #
1/2"	<b>FSC1<sup>ⓐ</sup></b>	<b>FDC1<sup>ⓐ</sup></b>
3/4"	<b>FSC2<sup>ⓐ</sup></b>	<b>FDC2<sup>ⓐ</sup></b>
1"	<b>FSC3<sup>ⓐ</sup></b>	<b>FDC3<sup>ⓐ</sup></b>

<sup>ⓐ</sup> Available in sand cast copper-free aluminum. To order, add suffix 'SCA' to end of catalog number.

<sup>ⓑ</sup> Available in copper-free aluminum. To order, add suffix 'SA' to end of catalog number.

<sup>ⓒ</sup> Compatible with select hinged and open front control station covers in Section 4C.

<sup>ⓓ</sup> Mounting lugs and ground screw are not offered with standard die cast aluminum box. For sand cast aluminum box with mounting lugs and ground screw, change 'SA' in catalog number to 'SCA.' For example: FS1 SCA.

# Condulet FS and FD single-gang device boxes – cast iron or aluminum

With and without mounting lugs for threaded rigid and IMC conduit

See pages 39-47 for accessories

## Ordering information (continued):

### FSA/FDA<sup>ⓐ</sup>



Hub size	Cat. #	Cat. #
1/2"	FSA1	FDA1
3/4"	FSA2	FDA2

### FSSA<sup>ⓐ</sup>



Hub size	Cat. #
3/4"	FSSA2

### FSLA/FDLA<sup>ⓐ</sup>



Hub size	Cat. #	Cat. #
1/2"	FSLA1	FDLA1
3/4"	FSLA2	FDLA2

### FSS/FDD<sup>ⓐ</sup>



Hub size	Cat. #	Cat. #
1/2"	FSS1 <sup>ⓐ</sup>	FDD1
3/4"	FSS2 <sup>ⓐ</sup>	FDD2 <sup>ⓐ</sup>
1"	FSS3	FDD3

## Dimensions (in inches):

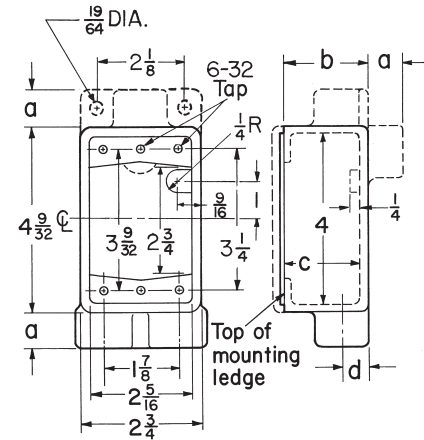
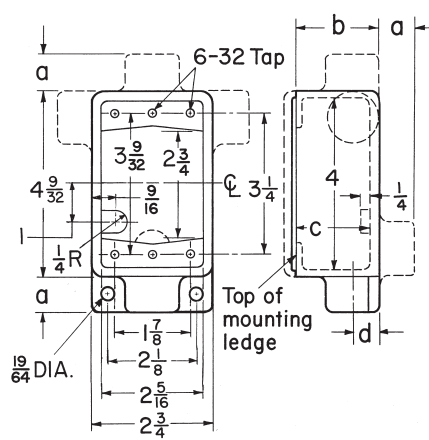

### FSCC/FDCC



Hub size	Cat. #	Cat. #
1/2"	FSCC1	FDCC1
3/4"	FSCC2	FDCC2

### FSCA<sup>ⓐ</sup>



Hub size	Cat. #
1/2"	FSCA1
3/4"	FSCA2

Series	Hub size	a	b	c	d
FS	1/2"	7/8	1 1/8	1 11/16	5/8
	3/4"	7/8	1 1/8	1 11/16	3/4
	1"	1	1 1/8	1 11/16	7/8
FD	1/2"	7/8	2 11/16	2 1/2	5/8
	3/4"	7/8	2 11/16	2 1/2	3/4
	1"	1	2 11/16	2 1/2	7/8

<sup>ⓐ</sup> Mounting lugs not available.

<sup>ⓑ</sup> Back entry hub is threaded.

<sup>ⓒ</sup> Available in copper-free aluminum. To order, add suffix 'SA' to end of catalog number.

# Condulet FS and FD single-gang device boxes – cast iron or aluminum

See pages 39-47 for accessories

With and without mounting lugs for threaded rigid and IMC conduit

## Ordering information (continued):

### FSCT/FDCT



Hub size	Cat. #	Cat. #
1/2"	FSCT1	FDCT1
3/4"	FSCT2 <sup>H</sup>	FDCT2 <sup>H</sup>
1"	FSCT3	FDCT3

### FSY



Description	Hub size	Cat. #
Single face	1"	FSY311
Double face	1"	FSY312

### FDXC

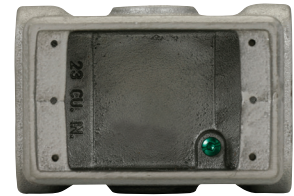

Hub size	Cat. #
3/4"	FDXC219

### FST/FDT

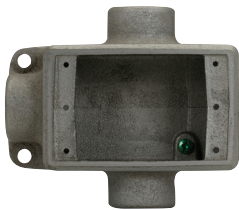

Hub size	Cat. #	Cat. #
1/2"	FST1	FDT1
3/4"	FST2 <sup>H</sup>	FDT2
1"	FST3	FDT3

## Dimensions (in inches):

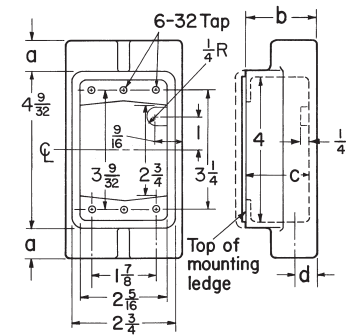
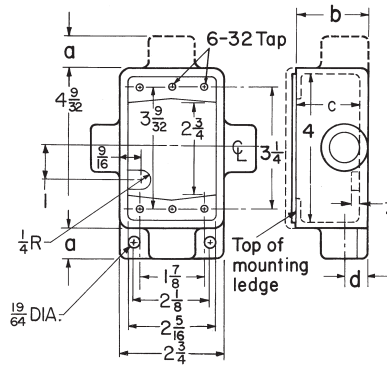

### FSX/FDX



Hub size	Cat. #	Cat. #
1/2"	FSX1	FDX1
3/4"	FSX2	FDX2
1"	FSX3	FDX3

### FSCT, FSX, FST, FSCD

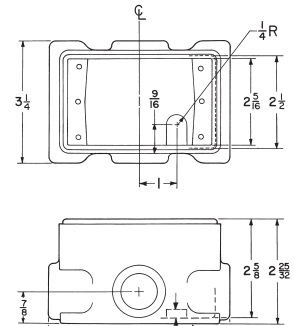
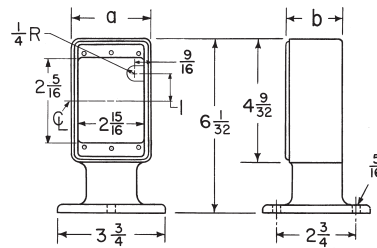

### FSCD



Hub size	Cat. #
1/2"	FSCD1
3/4"	FSCD2

## FSCT, FSX, FST, FSCD

Series	Hub size	a	b	c	d
FS	1/2"	7/8	1 1/8	1 11/16	5/8
	3/4"	7/8	1 1/8	1 11/16	3/4
	1"	1	1 1/8	1 11/16	7/8

## FSY

Description	Hub size	a	b
Single-gang, single face	1"	2 3/4	1 15/16
Single-gang, double face	1"	2 3/4	3 7/8

<sup>H</sup> Available in copper-free aluminum. To order, add suffix 'SA' to end of catalog number.

<sup>1</sup> Not available with mounting lugs.

<sup>2</sup> Six hubs – all 3/4" pipe tap.