

DLMULTI-024-300W

Description

Diffusion DLMULTI-024-300W is a Dimmable LED Driver that works with Forward / Reverse phase, ELV, Triac or 0-10V Dimmers.

Features

- Protection from short circuit, over current and over voltage
- Internal self reset mini breakers
- Compatible with virtually every style dimmer
- Flicker-free ~ 20,000 Hz
- Indoor/Outdoor
- High Efficiency
- Working Temp : -40 ~ +85° C
- Wet location rated

Specifications

- Input Voltage : 110-277 VAC
- Output Voltage : 24 VDC
- Output Current : 12.5A
- Dimming Range : 0-100%
- Wattage : 300W
0% with select dimmers only

Driver Dimensions :

10.0" L x 4.3" W x 1.7" H
255mm L x 110mm W x 45mm H

KO (I.D.):

6 x 0.8" (Sides)

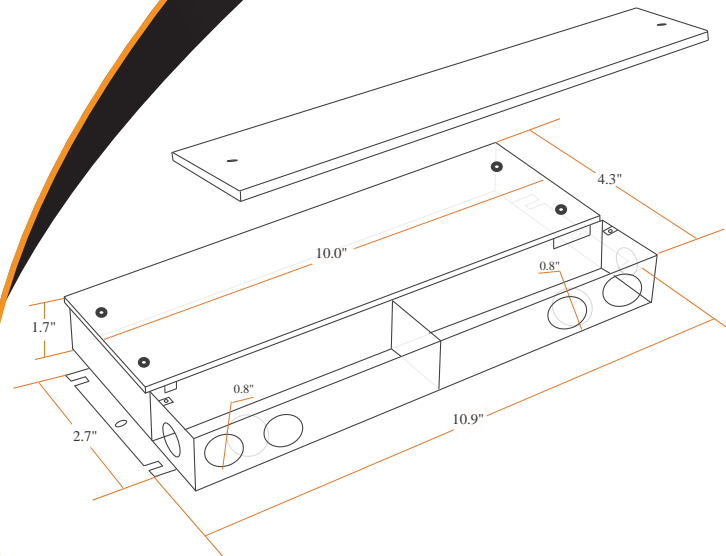

E516184