

CABLOFIL®

EZE-Fab™

*Prefab Assemblies & Wall
Box Mounting Components*

BRANCH CIRCUIT WIRING MADE EZE-ER THAN EVER



designed to be better.™

 **legrand**®



Reduce time and labor with EZE-Fab

EZE-ER ON THE JOB, EZE-ER ON YOU.

You face big challenges every single day. With a rapidly changing group of workers and ever-increasing demands from workloads, budgets, changing construction processes, clients and codes, it's hard to find time to get everything done. Reduce both time and labor with our EZE-Fab line of prefabricated branch circuit sub-assemblies. They're designed to work with our time-saving PlugTail® wiring devices that install in less than one minute. Speed through rough-in and trim-out with everything you need.



IDEAL FOR MANY COMMERCIAL APPLICATIONS

- Office
- Mixed Use
- Healthcare
- Hospitality
- Education

Solve many of your challenges with just one solution

CHALLENGE	SOLUTION WITH EZE-FAB + PLUGTAIL
Labor shortage	Eliminate repetitive assembly work
Accelerated project timelines	Quickest overall installation when combined with PlugTail <ul style="list-style-type: none"> • Up to 50% in time savings • PlugTail installs 3-5x faster than conventional devices
Safety concerns	Greatly reduce repetitive motions and screwdriver slips
Excessive packaging waste	Parts come assembled with reduced packaging



EZE-Fab prefabricated floor assembly installed in commercial office environment

Cut Installation Time in Half

COMPARE EZE-FAB SIDE-BY-SIDE TO A TRADITIONAL INSTALLATION

TRADITIONAL



0 MINUTES

No measuring required. Prefab assemblies are always to spec. Simply add a screw to keep it in position.



2 MINUTES

Traditional methods are limited to available stud positions, while prefab assemblies can be mounted anywhere on the base plate.



3 MINUTES

Everything's included. Prefab assemblies come with a built-in wire manager, pre-installed plaster rings and a far side wall support. No extra hardware needed.



6 MINUTES

Assembly on the job site is difficult and often done on the floor in awkward positions.



12 MINUTES

In just 6 minutes, the EZE-Fab rough-in is finished. A traditional rough-in takes twice as long at 12 minutes. With EZE-Fab, slash your installation time in half.

EZE-FAB



0 MINUTES



1 MINUTE



2 MINUTES



4 MINUTES

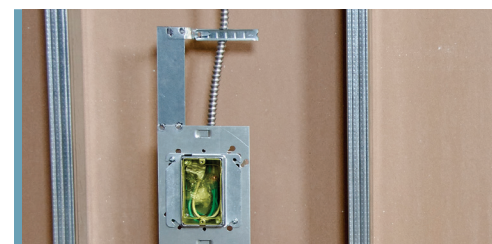

6 MINUTES

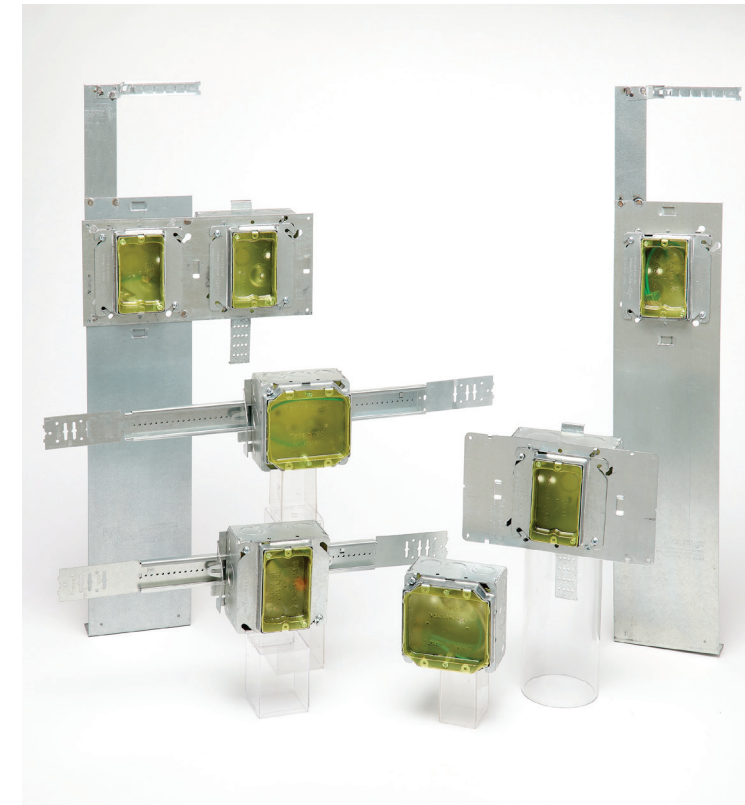

EZE-er Rough-In

EZE-FAB PREFAB ASSEMBLIES

Available in preconfigured combinations that satisfy the majority of commercial rough-ins, **these assemblies reduce the time you waste on repetitive work in the prefab shop or on the job site.** Arriving pre-assembled in the most commonly used configurations and optionally prewired with our universal switch or receptacle connectors, EZE-Fab prefab assemblies give you a faster, easier and more consistent install on any project.

Simply choose the type of bracket you need, then select from our options for the opening(s).

- Choose the bracket you need
- Select your opening and ring
- Place your Purchase Order

FEATURES & BENEFITS

- Box is set to the proper height
- Built-in cable support

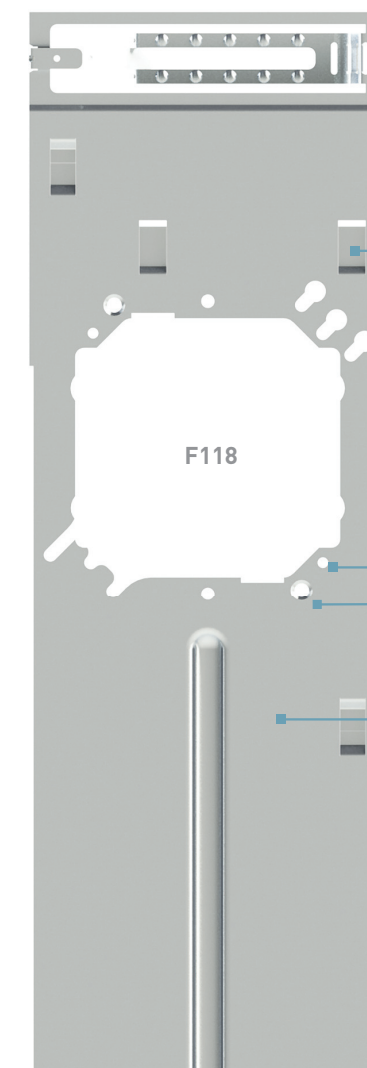

Integrated cable support

Support arms attach to the back of the bracket using the two slots provided

Keyhole openings allow 4", 4-11/16" and 5" x 2-1/8" boxes to remain attached

Attachment holes for 4" rings allow 4-11/16" x 2-1/8" boxes to be mounted independently

Attachment holes for 4-11/16" x 2-1/8" boxes allow 4" rings to be mounted independently

Multiple box heights are available from 12" to 24"

See page 10 for complete line of mounting components

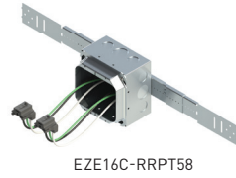

EZE16C-RRPT58

16" TELESCOPING BOX BRACKET			
ASSEMBLY CATALOG NUMBER	OPENING	PLASTER RING	SAP#
EZE16C-D5S1K58*	Empty 4-11/16" Square Box with 1" Knockouts	5/8" Fixed	EF000005
EZE16C-DGP58*	4" Square Box with Ground Pigtail and 1-Gang Ring	5/8" Fixed	EF000006
EZE16C-DDGP58	4" Square Box with Ground Pigtail and 2-Gang Ring	5/8" Fixed	EF000007
EZE16C-RPT58*	4" Square Box with 1-Gang Plaster Ring and 1 Grounded PlugTail Receptacle Connector	5/8" Fixed	EF000001
EZE16C-RRPT58	4" Square Box with 2-Gang Plaster Ring and 2 Grounded PlugTail Receptacle Connectors	5/8" Fixed	EF000002
EZE16C-SPT58	4" Square Box with 1-Gang Plaster Ring and 1 Grounded PlugTail Switch Connector	5/8" Fixed	EF000003
EZE16C-SSPT58	4" Square Box with 2-Gang Plaster Ring and 2 Grounded PlugTail Switch Connectors	5/8" Fixed	EF000004
EZE16C-D5S1KA	Empty 4-11/16" Square Box with 1" Knockouts	Adjustable	EF000012
EZE16C-DGPA	4" Square Box with Ground Pigtail and 1-Gang Ring	Adjustable	EF000013
EZE16C-DDGPA	4" Square Box with Ground Pigtail and 2-Gang Ring	Adjustable	EF000014
EZE16C-RPTA*	4" Square Box with 1-Gang Plaster Ring and 1 Grounded PlugTail Receptacle Connector	Adjustable	EF000008
EZE16C-RRPTA	4" Square Box with 2-Gang Plaster Ring and 2 Grounded PlugTail Receptacle Connectors	Adjustable	EF000009
EZE16C-SPTA	4" Square Box with 1-Gang Plaster Ring and 1 Grounded PlugTail Switch Connector	Adjustable	EF000010
EZE16C-SSPTA	4" Square Box with 2-Gang Plaster Ring and 2 Grounded PlugTail Switch Connectors	Adjustable	EF000011

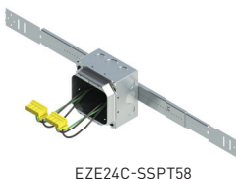

EZE24C-SSPT58

24" TELESCOPING BOX BRACKET			
ASSEMBLY CATALOG NUMBER	OPENING	PLASTER RING	SAP#
EZE24C-D5S1K58	Empty 4-11/16" Square Box with 1" Knockouts	5/8" Fixed	EF000019
EZE24C-DGP58	4" Square Box with Ground Pigtail and 1-Gang Ring	5/8" Fixed	EF000020
EZE24C-DDGP58	4" Square Box with Ground Pigtail and 2-Gang Ring	5/8" Fixed	EF000021
EZE24C-RPT58	4" Square Box with 1-Gang Plaster Ring and 1 Grounded PlugTail Receptacle Connector	5/8" Fixed	EF000015
EZE24C-RRPT58	4" Square Box with 2-Gang Plaster Ring and 2 Grounded PlugTail Receptacle Connectors	5/8" Fixed	EF000016
EZE24C-SPT58	4" Square Box with 1-Gang Plaster Ring and 1 Grounded PlugTail Switch Connector	5/8" Fixed	EF000017
EZE24C-SSPT58	4" Square Box with 2-Gang Plaster Ring and 2 Grounded PlugTail Switch Connectors	5/8" Fixed	EF000018
EZE24C-D5S1KA	Empty 4-11/16" Square Box with 1" Knockouts	Adjustable	EF000026
EZE24C-DGPA	4" Square Box with Ground Pigtail and 1-Gang Ring	Adjustable	EF000027
EZE24C-DDGPA	4" Square Box with Ground Pigtail and 2-Gang Ring	Adjustable	EF000028
EZE24C-RPTA	4" Square Box with 1-Gang Plaster Ring and 1 Grounded PlugTail Receptacle Connector	Adjustable	EF000022
EZE24C-RRPTA	4" Square Box with 2-Gang Plaster Ring and 2 Grounded PlugTail Receptacle Connectors	Adjustable	EF000072
EZE24C-SPTA	4" Square Box with 1-Gang Plaster Ring and 1 Grounded PlugTail Switch Connector	Adjustable	EF000024
EZE24C-SSPTA	4" Square Box with 2-Gang Plaster Ring and 2 Grounded PlugTail Switch Connectors	Adjustable	EF000025

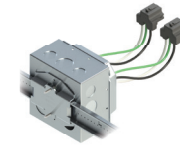

EZEBOX-RRPT58

BOX MOUNTING CLIP ADD-ON ASSEMBLIES FOR CWTBB SLIDER BRACKET				
ASSEMBLY CATALOG NUMBER	BRACKET	OPENING	PLASTER RING	SAP#
EZEBOX-D5S1K58*	Box Mounting Clip	Empty 4-11/16" Square Box with 1" Knockouts	5/8" Fixed	EF000033
EZEBOX-DGP58*	Box Mounting Clip	4" Square Box with Ground Pigtail and 1-Gang Ring	5/8" Fixed	EF000034
EZEBOX-DDGP58	Box Mounting Clip	4" Square Box with Ground Pigtail and 2-Gang Ring	5/8" Fixed	EF000035
EZEBOX-RPT58*	Box Mounting Clip	4" Square Box with 1-Gang Plaster Ring and 1 Grounded PlugTail Receptacle Connector	5/8" Fixed	EF000029
EZEBOX-RRPT58	Box Mounting Clip	4" Square Box with 2-Gang Plaster Ring and 2 Grounded PlugTail Receptacle Connectors	5/8" Fixed	EF000030
EZEBOX-SPT58	Box Mounting Clip	4" Square Box with 1-Gang Plaster Ring and 1 Grounded PlugTail Switch Connector	5/8" Fixed	EF000031
EZEBOX-SSPT58	Box Mounting Clip	4" Square Box with 2-Gang Plaster Ring and 2 Grounded PlugTail Switch Connectors	5/8" Fixed	EF000032
EZEBOX-D5S1KA	Box Mounting Clip	Empty 4-11/16" Square Box with 1" Knockouts	Adjustable	EF000039
EZEBOX-DGPA	Box Mounting Clip	4" Square Box with Ground Pigtail and 1-Gang Ring	Adjustable	EF000040
EZEBOX-DDGPA	Box Mounting Clip	4" Square Box with Ground Pigtail and 2-Gang Ring	Adjustable	EF000041
EZEBOX-RPTA	Box Mounting Clip	4" Square Box with 1-Gang Plaster Ring and 1 Grounded PlugTail Receptacle Connector	Adjustable	EF000036
EZEBOX-RRPTA	Box Mounting Clip	4" Square Box with 2-Gang Plaster Ring and 2 Grounded PlugTail Receptacle Connectors	Adjustable	EF000037
EZEBOX-SPTA	Box Mounting Clip	4" Square Box with 1-Gang Plaster Ring and 1 Grounded PlugTail Switch Connector	Adjustable	EF000069
EZEBOX-SSPTA	Box Mounting Clip	4" Square Box with 2-Gang Plaster Ring and 2 Grounded PlugTail Switch Connectors	Adjustable	EF000038

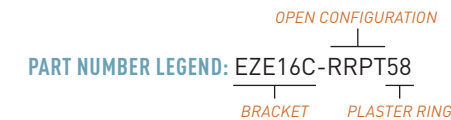

ELECTRICAL BOX DETAILS

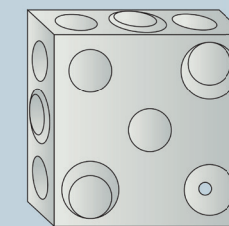

STANDARD BOX
4" X 4" X 2-1/8"
W/ 1/2" & 1/2" TO
3/4" CONCENTRIC KO'S

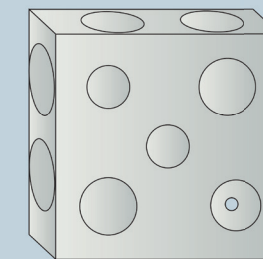

DATA BOX
4-11/16" X 4-11/16"
X 2-1/8" W/ 1/2", 3/4",
& 1" KO'S

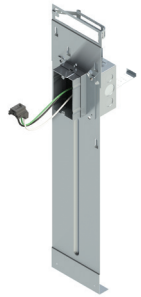

EZE118-RPTA

FLOOR BRACKET WITH 4" SQUARE BOX, ONE OPENING AND ADJUSTABLE BACK SUPPORT

ASSEMBLY CATALOG NUMBER	OPENING	PLASTER RING	SAP#
EZEF118-DGP58	Ground Pigtail and 1-Gang Ring	5/8" Fixed	EF000044
EZEF118-DDGP58	Ground Pigtail and 2-Gang Ring	5/8" Fixed	EF000045
EZEF118-RPT58	1-Gang Plaster Ring and 1 Grounded PlugTail Receptacle Connector	5/8" Fixed	EF000042
EZEF118-RRPT58	2-Gang Plaster Ring and 2 Grounded PlugTail Receptacle Connectors	5/8" Fixed	EF000043
EZEF118-DGPA	Ground Pigtail and 1-Gang Ring	Adjustable	EF000048
EZEF118-DDGPA	Ground Pigtail and 2-Gang Ring	Adjustable	EF000049
EZEF118-RPTA*	1-Gang Plaster Ring and 1 Grounded PlugTail Receptacle Connector	Adjustable	EF000046
EZEF118-RRPTA	2-Gang Plaster Ring and 2 Grounded PlugTail Receptacle Connectors	Adjustable	EF000047



EZE218-RPTA-TA

FLOOR BRACKET WITH 4" SQUARE BOX, TWO OPENINGS AND ADJUSTABLE BACK SUPPORT

ASSEMBLY CATALOG NUMBER	FIRST OPENING	SECOND OPENING	PLASTER RING	SAP#
EZEF218-RPT58-T58	1-Gang Plaster Ring and 1 Grounded PlugTail Receptacle Connector	1-Gang Plaster Ring	5/8" Fixed	EF000050
EZEF218-RPT58-D5S1K58	1-Gang Plaster Ring and 1 Grounded PlugTail Receptacle Connector	Empty 4-11/16" Square Box with 1" Knockouts	5/8" Fixed	EF000051
EZEF218-RRPT58-D5S1K58	2-Gang Plaster Ring and 2 Grounded PlugTail Receptacle Connectors	Empty 4-11/16" Square Box with 1" Knockouts	5/8" Fixed	EF000052
EZEF218-RPTA-TA	1-Gang Plaster Ring and 1 Grounded PlugTail Receptacle Connector	1-Gang Plaster Ring	Adjustable	EF000053
EZEF218-RPTA-D5S1KA*	1-Gang Plaster Ring and 1 Grounded PlugTail Receptacle Connector	Empty 4-11/16" Square Box with 1" Knockouts	Adjustable	EF000054
EZEF218-RRPTA-D5S1KA	2-Gang Plaster Ring and 2 Grounded PlugTail Receptacle Connectors	Empty 4-11/16" Square Box with 1" Knockouts	Adjustable	EF000055

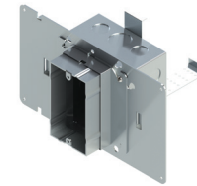

EZE1-D5S1KA

WALL BRACKETS WITH ONE OPENING AND ADJUSTABLE BACK SUPPORT

ASSEMBLY CATALOG NUMBER	OPENING	PLASTER RING	SAP#
EZE1-D5S1K58*	Empty 4-11/16" Square Box with 1" Knockouts	5/8" Fixed	EF000060
EZE1-DGP58*	4" Square Box with Ground Pigtail and 1-Gang Ring	5/8" Fixed	EF000061
EZE1-DDGP58	4" Square Box with Ground Pigtail and 2-Gang Ring	5/8" Fixed	EF000062
EZE1-RPT58	4" Square Box with 1-Gang Plaster Ring and 1 Grounded PlugTail Receptacle Connector	5/8" Fixed	EF000056
EZE1-RRPT58	4" Square Box with 2-Gang Plaster Ring and 2 Grounded PlugTail Receptacle Connectors	5/8" Fixed	EF000057
EZE1-SPT58	4" Square Box with 1-Gang Plaster Ring and 1 Grounded PlugTail Switch Connector	5/8" Fixed	EF000058
EZE1-SSPT58	4" Square Box with 2-Gang Plaster Ring and 2 Grounded PlugTail Switch Connectors	5/8" Fixed	EF000059
EZE1-TA	1-Gang Plaster Ring	Adjustable	EF000068
EZE1-D5S1KA	Empty 4-11/16" Square Box with 1" Knockouts	Adjustable	EF000067
EZE1-DGPA	4" Square Box with Ground Pigtail and 1-Gang Ring	Adjustable	EF000070
EZE1-DDGPA	4" Square Box with Ground Pigtail and 2-Gang Ring	Adjustable	EF000071
EZE1-RPTA*	4" Square Box with 1-Gang Plaster Ring and 1 Grounded PlugTail Receptacle Connector	Adjustable	EF000063
EZE1-RRPTA	4" Square Box with 2-Gang Plaster Ring and 2 Grounded PlugTail Receptacle Connectors	Adjustable	EF000064
EZE1-SPTA	4" Square Box with 1-Gang Plaster Ring and 1 Grounded PlugTail Switch Connector	Adjustable	EF000065
EZE1-SSPTA	4" Square Box with 2-Gang Plaster Ring and 2 Grounded PlugTail Switch Connectors	Adjustable	EF000066

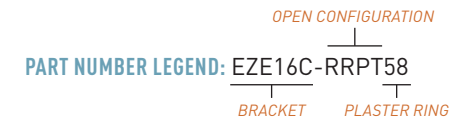

SHIPS IN BOXES OF 10





EZE-er Trim-Out

PASS & SEYMOUR® PLUGTAIL ELECTRICAL WIRING DEVICES

PlugTail wiring devices redefine simplicity for electrical systems. EZE-Fab prefab assemblies come pre-installed with universal PlugTail switch or receptacle connectors - so there's no need to determine the devices upfront or wrestle with last minute changes. You can breeze through rough-in with a standardized assembly and select from an incredibly thorough line of electrical devices later. Once you pick them, all you need to do is click in the device and mount it to the box. Say goodbye to preparing, stripping, looping and taping. And as buildings and requirements change, it's incredibly easy to swap devices in and out to make the upgrades you need.



FEATURES & BENEFITS

- PlugTail installs up to 5x faster than conventional devices - no screwing, stripping or taping
- Adjustable mud rings allow you to level the device perfectly with a few turns of a screwdriver
- Device change outs are easy in the future
- Reduces repetitive motions like screwdriver turns and prevents screwdriver slips
- Circuits can be tested at rough-in or trim-out with PlugTail tester
- PlugTail line includes straight blade receptacles, switches, sensors, timers, GFCIs, USB charging options and more

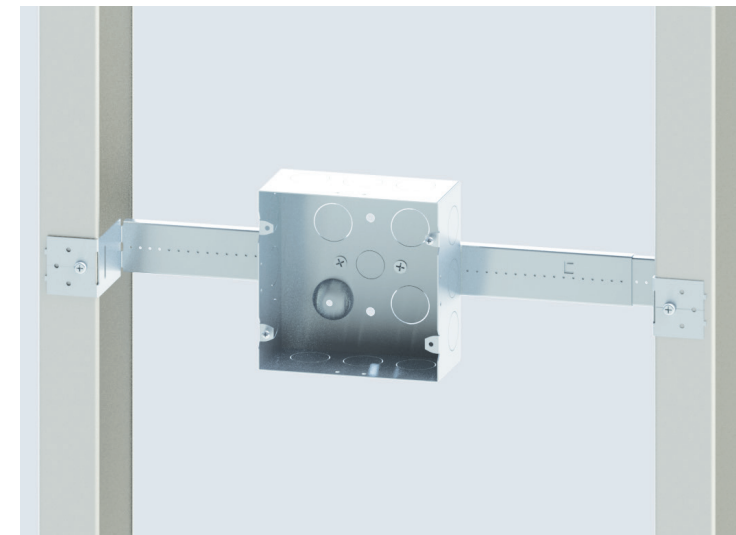

EZE-er Projects

WALL BOX MOUNTING COMPONENTS

Whether you simply need extra stock on hand or you're looking for pieces to do your own assemblies in a prefab shop, our collection of Cablofil® wall box mounting components has you covered. Choose from a wide variety of box brackets, mounting plates, rings and plastic device covers to supplement your project needs and construct your own assemblies.

ADJUSTABLE RINGS

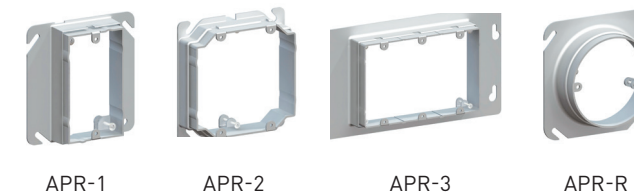

PLASTIC DEVICE COVERS

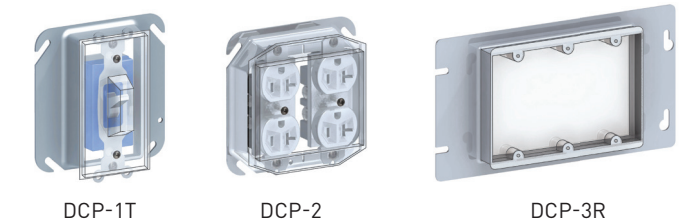

TELESCOPING BOX BRACKETS

Quick and easy field fabrication for octagonal standard box depths

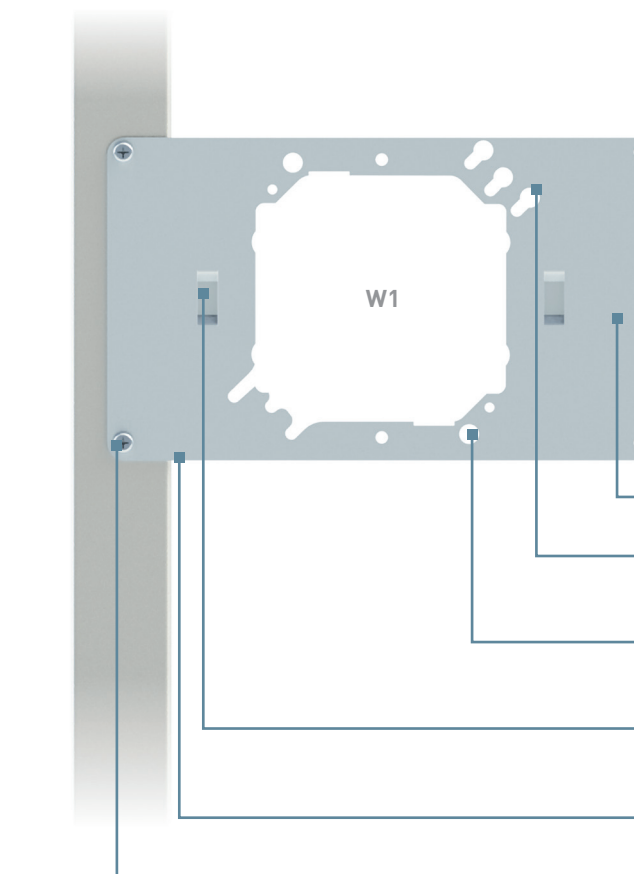
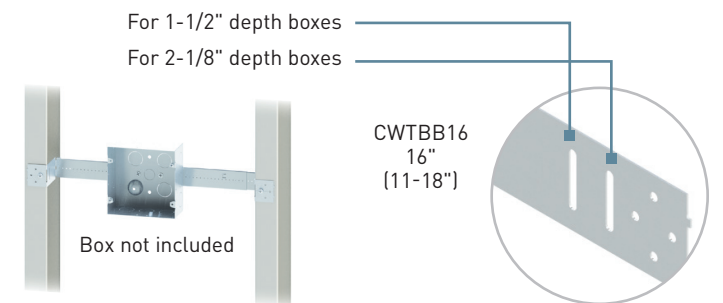

WALL BRACKETS

- Symmetrical design allows simpler and easier prefab
- Keyhole openings allow 4", 4-11/16" and 5" x 2-1/8" boxes to remain attached when plaster ring is removed
- Counter sunk box attachment holes for 4-11/16" x 2-1/8" boxes allow 4" rings to be mounted independently
- Support arms are attached to the back of the bracket using the two slots provided
- Stud alignment tabs - (W1, W34, W4 only)
- Wall bracket attachment holes

Wall Box Mounting Components

Choose from popular components to build your own assemblies or be ready for projects that pop up.

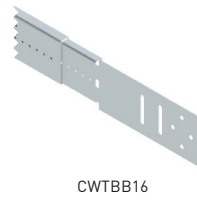

TELESCOPING BOX BRACKETS						
CATALOG NUMBER	DESCRIPTION	PKG. QTY.	MIN. LENGTH (IN)	MAX. LENGTH (IN)	PKG. WEIGHT (LBS)	PG
CWTBB16	Telescoping Box Bracket	50	11	18	25	F000065
CWTBB24	Telescoping Box Bracket	50	17	26	33	F000066
CWTSB	Telescoping Support Bracket	25	16	27	20	F000067
CWTBBC	Box Mounting Clip for CWTBB Slider Bracket	50	-	-	8.2	F002161

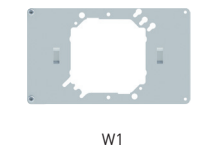

WALL BRACKETS						
CATALOG NUMBER	DESCRIPTION	PKG. QTY.	OPENINGS	HEIGHT (IN)	WIDTH (IN)	PG
W1	Wall Brackets	25	1	5	8.5	FP211097
W2	Wall Brackets	25	2	5	11	FP211101
W3	Wall Brackets	25	3	5	16.75	FP211103
W4	Wall Brackets	25	4	5	26	FP211105
W34	Wall Brackets	25	3	5	26	FP211104
W16SSL	Wall Brackets	25	16" Slider	6	16.75	FP211100
W24SSL	Wall Brackets	25	24" Slider	6	26	FP211102

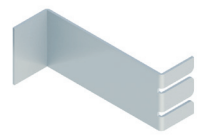

SUPPORT ARMS				
CATALOG NUMBER	DESCRIPTION	PKG. QTY.	WALL DEPTH (IN)	PG
AR250/600	Adjustable Support Arm	50	2.5-6	FP211055
AR250	Fixed Depth Support Arm	50	2.5	FP211040
AR300	Fixed Depth Support Arm	50	3	FP211041
AR350	Fixed Depth Support Arm	50	3.5	FP211042
AR400	Fixed Depth Support Arm	50	4	FP211043
AR450	Fixed Depth Support Arm	50	4.5	FP211044
AR500	Fixed Depth Support Arm	50	5	FP211045
AR600	Fixed Depth Support Arm	50	6	FP211048
AR650	Fixed Depth Support Arm	50	6.5	FP211049

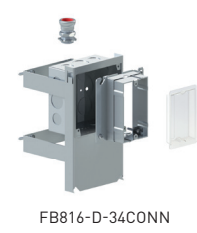

CONCRETE BLOCK WALL BOX BRACKET			
CATALOG NUMBER	DESCRIPTION	PKG. QTY.	PG
FB816	Concrete Wall Bracket Only	1	FP271884
FB816-D-12CONN	Concrete Wall Bracket and 1/2" EMT Assembly	1	FP003697
FB816-D-34CONN	Concrete Wall Bracket and 3/4" EMT Assembly	1	FP003698
FB816-D-1CONN	Concrete Wall Bracket and 1" EMT Assembly	1	FP003699



FLOOR BRACKETS								
CATALOG NUMBER	DESCRIPTION	PKG. QTY.	OPENINGS	CENTER HEIGHT		BRACKET WIDTH		PG
F112	Floor Brackets	25	1	12	300	5	125	FP981552
F115	Floor Brackets	25	1	15	380	5	125	FP981553
F118	Floor Brackets	25	1	18	450	5	125	FP981555
F124	Floor Brackets	25	1	24	600	5	125	FP981556
F212	Floor Brackets	25	2	12	300	5	125	FP981557
F215	Floor Brackets	25	2	15	380	5	125	FP981558
F218	Floor Brackets	25	2	18	450	5	125	FP981560
F224	Floor Brackets	25	2	24	600	5	125	FP981561
F312	Floor Brackets	25	3	12	300	5	125	FP981562
F315	Floor Brackets	25	3	15	380	5	125	FP981563
F318	Floor Brackets	25	3	18	450	5	125	FP981565
F324	Floor Brackets	25	3	24	600	5	125	FP981566
F418	Floor Brackets	25	4	18	450	5	125	FP981593

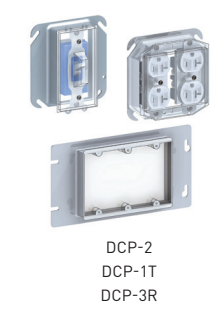

PLASTIC DEVICE COVERS				
CATALOG NUMBER	PKG. QTY.	BOX SIZE / DEVICE TYPE	FASTENERS INCLUDED	PL
DCP-1	50	Single Gang Receptacle	(2) #8-32 Screws	FP003414
DCP-2	50	Double Gang Receptacle	(2) #8-32 Screws	FP003416
DCP-3	50	Three Gang Receptacle	(2) #8-32 Screws	FP003418
DCP-4	50	Four Gang Receptacle	(2) #8-32 Screws	FP003420
DCP-1T	50	Single Gang Toggle Switch	(2) #8-32 Screws	FP003415
DCP-2T	50	Double Gang Toggle Switch	(2) #8-32 Screws	FP003417
DCP-3T	50	Three Gang Toggle Switch	(2) #8-32 Screws	FP003419
DCP-4T	50	Four Gang Toggle Switch	(2) #8-32 Screws	FP003421
DCP-DT	50	Dbl. Gang Toggle Switch & Device	(2) #8-32 Screws	FP003422
DCP-1R	50	Single Gang Cover Only	None	FP231068
DCP-2R	50	Double Gang Cover Only	None	FP231071
DCP-3R	50	Three Gang Cover Only	None	FP231074
DCP-4R	50	Four Gang Cover Only	None	FP231077
DCP-R	50	3" Round Cover Only	None	FP231080



ADJUSTABLE RINGS				
CATALOG NUMBER	PKG. QTY.	BOX SIZE / DEVICE TYPE	RING ADJUSTMENT	PG
APR-1-5/8	25	Single gang	5/8" to 1 1/4"	FP211051
APR-1	25	Single gang	3/4" to 1 1/2"	FP211050
APR-2	25	Two Gang	5/8" to 1 1/2"	FP211052
APR-3	25	Three Gang	3/4" to 1 1/2"	FP211053
APR-R	25	3-0 Round	3/4" to 1 1/2"	FP211054



WALL BRACES FOR FLOOR BRACKETS			
CATALOG NUMBER	PKG. QTY.	STUD SPACING (IN)	PG
T16	50	16	FP211108
T24	50	24	FP211112

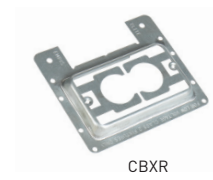

LOW VOLTAGE MOUNTING PLATES			
CATALOG NUMBER	PKG. QTY.	BOX SIZE / DEVICE TYPE	PG
CBXR	-	Single gang	F002079
CBX1	100	Single gang, w/ Screws	F002011

Choose a solution for branch circuit wiring

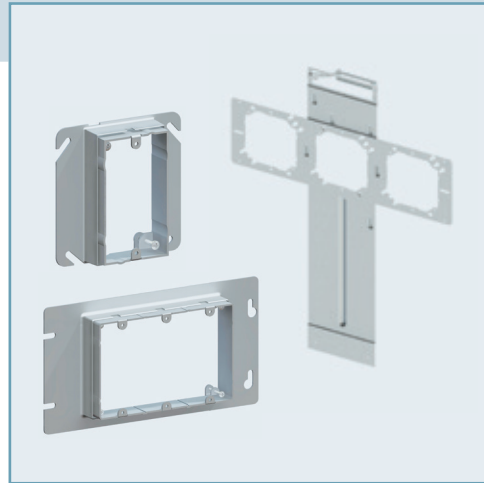

WALL BOX MOUNTING COMPONENTS

Part of the Cablofil fastener line, a wide variety of everyday components in boxed quantities help you finish projects quickly in your prefab shop or on the job site.

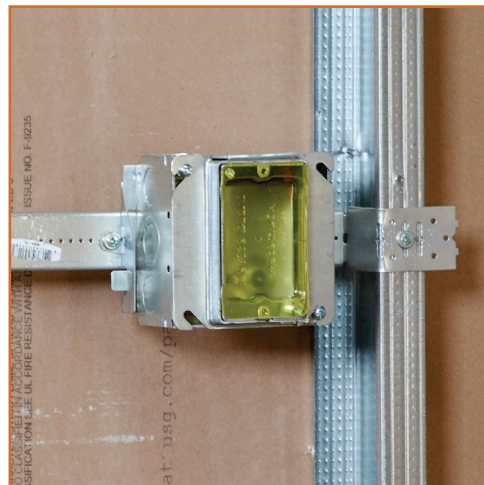

EZE-FAB™ PREFAB ASSEMBLIES

Slash your installation time in half - and spend less time in your prefab shop or on the job site. Ready to ship quickly, EZE-Fab prefab assemblies are available in the most popular configurations.



FAS POWER™

Fully-engineered solutions built custom to your specifications. Contractors and Legrand Project Services collaborate throughout the entire project.

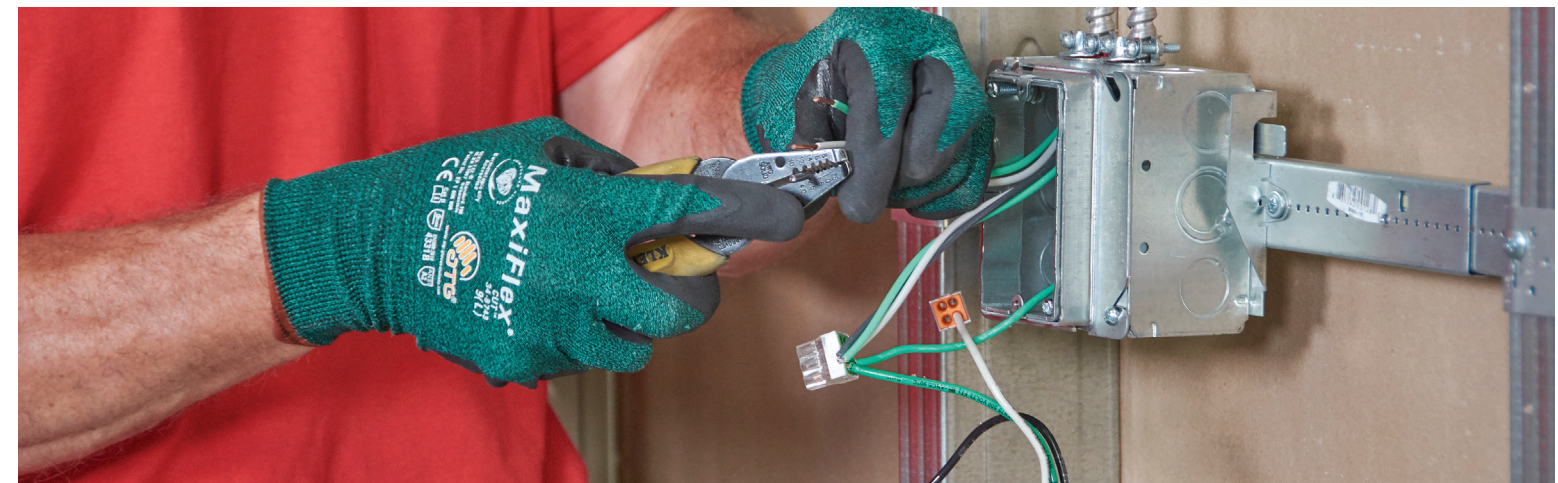

LEARN MORE: WWW.LEGRAND.US/EZE-FAB

designed to be better.™



Electrical Wiring Systems
60 Woodlawn Street
West Hartford, CT 06110
1.877.BY.LEGRAND (295.3472)
www.legrand.us

Canada
1.800.723.5175; 905.738.9195
www.legrand.ca

Costa Rica
+506.298.56.04; +506.239.71.13
www.legrand.cr

FOLLOW US

