

**GENERAL INFORMATION**

**MINI-UNDERCUT+™**

Internally Threaded Undercut Anchor

**PRODUCT DESCRIPTION**

The Mini-Undercut+ anchor is an internally threaded, self-undercutting anchor designed for performance in cracked and uncracked concrete. Suitable base materials include post-tension concrete (PT slabs), hollow-core precast concrete, normal-weight concrete and sand-lightweight concrete. The Mini-Undercut+ anchor is installed into a pre-drilled hole with a power tool and a setting tool. After installation a steel element is threaded into the anchor body. The result is an anchor which can provide consistent behavior at shallow embedments as low as 3/4 of an inch.

**GENERAL APPLICATIONS AND USES**

- Tension zones, seismic and wind loading applications
- Fire Sprinkler & pipe supports
- Suspended Conduit
- Cable Trays and Strut
- Suspended Lighting

**FEATURE AND BENEFITS**

- + Ideal for precast hollow-core plank and post-tensioned concrete slabs
- + Cracked concrete tested alternative to a mini dropin anchor
- + ANSI carbide stop bit with enlarged shoulder for accurate drill depth
- + Anchor design allows for shallow embedment as low as 3/4 of an inch
- + Internally threaded anchor for easy adjustment and removability of threaded rod or bolt
- + Drill and drive the anchor with one tool for fast anchor installation

**APPROVALS AND LISTINGS**

- International Code Council, Evaluation Service (ICC-ES), ESR-3912 for Concrete and Hollow-Core precast slabs, code compliant with the International Building Code/International Residential Code: 2018 IBC/IRC, 2015 IBC/IRC, 2012 IBC/IRC, and 2009 IBC/IRC
- Tested in accordance with ACI 355.2 (including ASTM E 488) and ICC-ES AC193 for use in concrete under the design provisions of ACI 318-14 Chapter 17 or ACI 318-11/08 Appendix D
- Evaluated and qualified by an accredited independent testing laboratory for recognition in cracked and uncracked concrete including seismic and wind loading (Category 1 anchors)
- FM Approvals (Factory Mutual) – File No. J.I. 3059197

**GUIDE SPECIFICATIONS**

CSI Divisions: 03 16 00 - Concrete Anchoring and 05 05 19 - Post Installed Concrete Anchors. Expansion anchors shall be Mini-Undercut+ as supplied by DEWALT, Towson, MD. Anchors shall be installed in accordance with published instructions and the Authority Having Jurisdiction.

**SECTION CONTENTS**

General Information..... 1  
 Installation Instructions..... 2  
 Reference Data (ASD)..... 3  
 Strength Design (SD)..... 4  
 Ordering Information..... 6

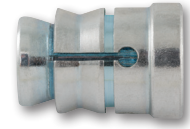

MINI-UNDERCUT+

**THREAD VERSION**

- UNC Thread

**ANCHOR MATERIALS**

- Zinc plated carbon steel

**ANCHOR SIZE RANGE (TYP.)**

- 3/8"

**SUITABLE BASE MATERIALS**

- Post-Tension Concrete
- Precast Hollow-Core Plank
- Normal-weight concrete
- Lightweight concrete



## INSTALLATION INSTRUCTIONS

### INSTALLATION PROCEDURE (USING SDS PLUS SYSTEM)

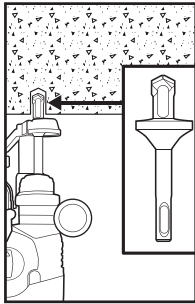

Using the required stop drill bit, drill a hole into the base material to the required depth using the shoulder of the drill bit as a guide. The tolerances of the drill bit used must meet the requirements of ANSI Standard B212.15.

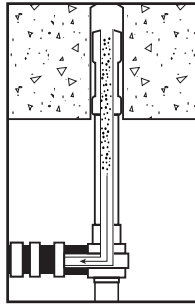

Remove dust and debris from the hole during drilling (e.g. dust extractor) or following drilling (e.g. suction forced air) to extract loose particles created by drilling.

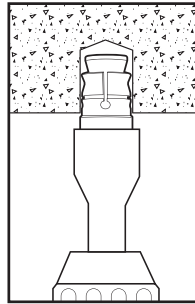

Attach the required SDS setting tool to the hammer-drill. Mount the open end of the anchor onto the setting tool. Drive the anchor into the hole until the shoulder of the anchor is flush with the base material.

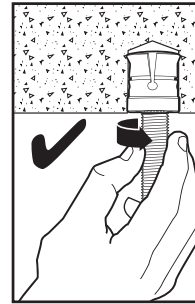

Thread the rod or bolt by hand until snug tight (minimum of 4 full rotations).

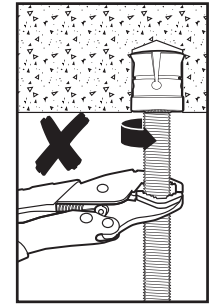

Do not further tighten with adjustable wrench or similar tool.

### Installation Information for Mini-Undercut+ Anchor and Supplemental Information<sup>1,2,3</sup>

Anchor Property/Setting Information	Symbol	Units	Nominal Anchor Diameter (inch)	
			3/8	
Anchor outside diameter	$d_a$	in. (mm)	0.625 (15.9)	
Internal thread diameter (UNC)	$d$	in. (mm)	3/8 (9.5)	
Nominal drill bit diameter	$d_{bit}$	in. (mm)	5/8 ANSI	
Minimum nominal embedment depth	$h_{nom}$	in. (mm)	3/4 (19)	
Effective embedment depth	$h_{ef}$	in. (mm)	3/4 (19)	
Hole depth	$h_o$	in. (mm)	3/4 (19)	
Overall anchor length (before setting)	$l_{anch}$	in. (mm)	15/16 (24)	
Approximate tool impact power (hammer-drill)	-	J	2.1 to 3.0	
Minimum diameter of hole clearance in fixture for steel insert element (following anchor installation)	$d_h$	in.	7/16	
Minimum member thickness in concrete	$h_{min}$	in. (mm)	2-1/2 (64)	
Minimum cover thickness in hollow core concrete slabs (see Hollow-Core concrete figure)	$h_{min,core}$	in. (mm)	1-1/2 (38)	
Minimum edge distance	$c_{min}$	in. (mm)	2-1/2 (64)	
Minimum spacing distance	$s_{min}$	in. (mm)	3 (76)	
Maximum installation torque	$T_{max}$	ft.-lb. (N-m)	5 (7)	
Effective tensile stress area (undercut anchor body)	$A_{se}$	in. <sup>2</sup> (mm <sup>2</sup> )	0.044 (28.4)	
Minimum specified ultimate strength	$f_{uta}$	psi (N/mm <sup>2</sup> )	95,000 (655)	
Minimum specified yield strength	$f_{ya}$	psi (N/mm <sup>2</sup> )	76,000 (524)	
Mean axial stiffness <sup>4</sup>	Uncracked concrete	$\beta_{uncr}$	lbf/in.	50,400
	Cracked concrete	$\beta_{cr}$	lbf/in.	29,120

For Sl: 1 inch = 25.4 mm, 1 ft-lbf = 1.356 N-m.

- The information presented in this table is to be used in conjunction with the design criteria of ACI 318-14 Chapter 17 or ACI 318-11 Appendix D, as applicable.
- For installation detail for anchors in hollow-core concrete slabs, see Hollow-Core concrete figure.
- The embedment depth,  $h_{nom}$ , is measured from the outside surface of the concrete member to the embedded end of the anchor.
- Mean values shown, actual stiffness varies considerably depending on concrete strength, loading and geometry of application.

**Mini-Undercut+ Anchor Detail**

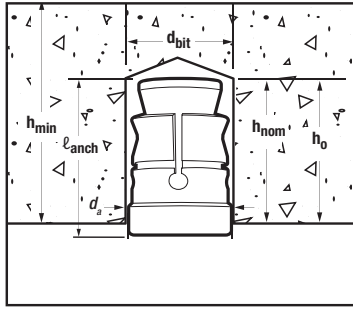

Before

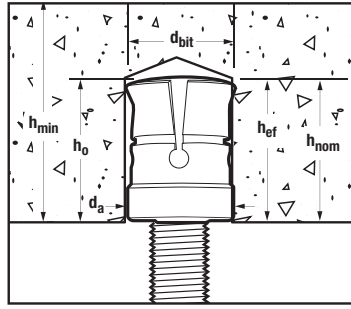

After

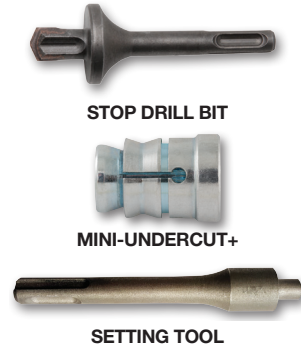

**Mini-Undercut+ Anchor Installed with Steel Insert Element**

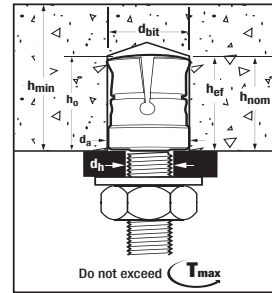
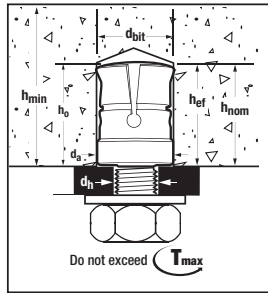
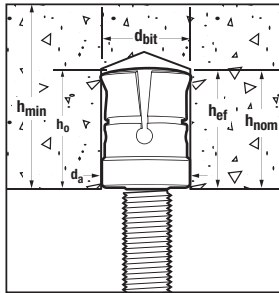

**REFERENCE DATA (ASD)**

**Ultimate and Allowable Tension Load Capacities for Mini-Undercut+ in Normal-Weight Concrete**<sup>1,2,3,4</sup>



Nominal Rod/Anchor Diameter d in.	Minimum Nominal Embed. Depth in. (mm)	Minimum Concrete Compressive Strength							
		f'c = 3,000 psi (20.7 MPa)				f'c = 4,000 psi (27.6 MPa)			
		Ultimate		Allowable		Ultimate		Allowable	
		Tension lbs (kN)	Shear lbs (kN)	Tension lbs (kN)	Shear lbs (kN)	Tension lbs (kN)	Shear lbs (kN)	Tension lbs (kN)	Shear lbs (kN)
3/8	3/4 (19)	1,535 (6.8)	1,975 (8.8)	385 (1.7)	495 (2.2)	1,770 (7.9)	2,275 (10.1)	445 (2.0)	570 (2.5)

1. Tabulated load values are for anchors installed in concrete. Concrete compressive strength must be at the specified minimum at the time of installation.
2. Allowable load capacities are calculated using an applied safety factor of 4.0.
3. Linear interpolation may be used to determine allowable loads for intermediate compressive strengths.
4. For lightweight concrete, tabulated values must be multiplied by 0.60.

**Ultimate and Allowable Tension Load Capacities for Mini-Undercut+ in Hollow-Core Plank**<sup>1,2,3</sup>



Nominal Rod/Anchor Diameter d in.	Minimum Nominal Embed. Depth in. (mm)	Minimum Concrete Compressive Strength											
		f'c = 5,000 psi (34.5 MPa)				f'c = 6,000 psi (41.4 MPa)				f'c = 8,000 psi (55.2 MPa)			
		Ultimate		Allowable		Ultimate		Allowable		Ultimate		Allowable	
		Tension lbs (kN)	Shear lbs (kN)	Tension lbs (kN)	Shear lbs (kN)	Tension lbs (kN)	Shear lbs (kN)	Tension lbs (kN)	Shear lbs (kN)	Tension lbs (kN)	Shear lbs (kN)	Tension lbs (kN)	Shear lbs (kN)
3/8	3/4 (19)	1,855 (8.3)	2,590 (11.5)	465 (2.1)	650 (2.9)	2,035 (9.1)	2,835 (12.6)	510 (2.3)	710 (3.2)	2,345 (10.4)	3,275 (14.6)	585 (2.6)	820 (3.6)

1. Tabulated load values are for anchors installed in concrete. Concrete compressive strength must be at the specified minimum at the time of installation.
2. Allowable load capacities are calculated using an applied safety factor of 4.0.
3. Linear interpolation may be used to determine allowable loads for intermediate compressive strengths.

**Mini-Undercut+ Installed Detail for Anchor in the Underside of Hollow-Core Concrete slabs**

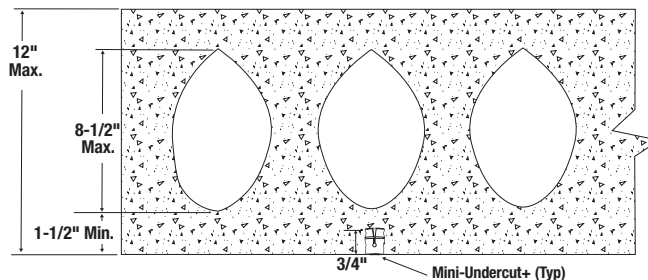

**STRENGTH DESIGN (SD)**
**Tension Design Information for Mini-Undercut+ Anchors in the Underside of Concrete and the Underside of Hollow-Core Concrete Slabs**<sup>1,2,3,4,5,6,7,8</sup>
**CODE LISTED**  
 ICC-ES ESR-3912

Design Characteristic	Notation	Units	Nominal Anchor Size / Threaded Rod Diameter (inch)
			3/8
Anchor category	1, 2 or 3	-	1
Nominal embedment depth	$h_{nom}$	in. (mm)	3/4 (19)
<b>Steel Strength In Tension (ACI 318-14 17.4.1 or ACI 318-11 D.5.1)</b>			
Steel strength in tension	$N_{sa}$	lb (kN)	4,180 (18.6)
Reduction factor for steel strength	$\phi$	-	0.65
<b>Concrete Breakout Strength In Tension (ACI 318-14 17.4.2 or ACI 318-11 D.5.2)</b>			
Effective embedment	$h_{ef}$	in. (mm)	3/4 (19)
Effectiveness factor for uncracked concrete	$k_{uncr}$	-	24
Effectiveness factor for cracked concrete	$k_{cr}$	-	17
Modification factor for cracked and uncracked concrete	$\Psi_{c,N}$	-	1.0 (see note 5)
Critical edge distance - splitting (uncracked concrete only)	$c_{ac}$	in. (mm)	2.5 (64)
Reduction factor, concrete breakout strength <sup>3</sup>	$\phi$	-	0.40
<b>Pullout Strength In Tension (ACI 318-14 17.4.3 or ACI 318-11 D.5.3)</b>			
Pullout strength, uncracked concrete	$N_{p,uncr}$	lb (kN)	See note 7
Pullout strength, cracked concrete	$N_{p,cr}$	lb (kN)	455 (2.0)
Reduction factor, pullout strength	$\phi$	-	0.40
<b>Pullout Strength In Tension For Seismic Applications (ACI 318-14 17.2.3.3 or ACI 318-11 D.3.3.3)</b>			
Characteristic pullout strength, seismic	$N_{p,eq}$	lb (kN)	410 (1.82)
Reduction factor, pullout strength, seismic	$\phi$	-	0.40

 For SI: 1 inch = 25.4 mm, 1 ksi = 6.894 N/mm<sup>2</sup>; 1 lbf = 0.0044 kN.

- The data in this table is intended to be used with the design provisions of ACI 318-14 Chapter 17 or ACI 318-11 Appendix D, as applicable; for anchors resisting seismic load combinations the additional requirements of ACI 318-14 17.2.3 or ACI 318-11 D.3.3, as applicable, shall apply.
- Installation must comply with manufacturer's published installation instructions and details.
- All values of  $\phi$  are applicable with the load combinations of IBC Section 1605.2, ACI 318-14 Section 5.3, or ACI 318-11 Section 9.2.
- The threaded rod or bolt strength must also be checked, and the controlling value of  $\phi N_{sa}$  between the anchor and rod must be used for design.
- Select the appropriate effectiveness factor for cracked concrete ( $k_{cr}$ ) or uncracked concrete ( $k_{uncr}$ ) and use  $\Psi_{c,N} = 1.0$ .
- The characteristic pullout strength for concrete compressive strengths greater than 2,500 psi for anchors may be increased by multiplying the value in the table by  $(f'c / 2,500)^{0.5}$  for psi or  $(f'c / 17.2)^{0.5}$ . For hollow-core concrete slabs the characteristic pullout strength for concrete compressive strengths greater than 6,000 psi for anchors may be increased by multiplying the value in the table by  $(f'c / 6,000)^{0.5}$  for psi or  $(f'c / 41.4)^{0.5}$ .
- Reported values for characteristic pullout strength in tension for seismic applications are based on test results per ACI 355.2, Section 9.5.
- Anchors are permitted to be used in sand-lightweight concrete provided the modification factor  $\lambda_a$  equal to  $0.8\lambda$  is applied to all values of  $\sqrt{f'c}$  affecting  $N_n$  and  $V_n$ .  $\lambda$  shall be determined in accordance with the corresponding version of ACI 318.

### Shear Design Information for Mini-Undercut+ Anchors in the Underside of Concrete and the Underside of Hollow-Core Concrete Slabs<sup>1,2,3,4,5,6,7</sup>

**CODE LISTED**  
ICC-ES ESR-3912



Design Characteristic	Notation	Units	Nominal Anchor Size / Threaded Rod Diameter (inch)
			3/8
Anchor category	1, 2 or 3	-	1
Nominal embedment depth	$h_{nom}$	in. (mm)	3/4 (19)
<b>Steel Strength in Shear (ACI 318-14 17.5.1 or ACI 318-11 D.6.1)</b>			
Steel strength in shear	$V_{sa}$	lb (kN)	985 (4.4)
Reduction factor, steel strength	$\phi$	-	0.60
<b>Steel Strength in Shear for Seismic (ACI 318-14 17.2.3.3 or ACI 318-11 D.3.3.3)</b>			
Steel strength in shear, seismic	$V_{sa,eq}$	lb (kN)	895 (4.0)
Reduction factor, steel strength in shear, seismic	$\phi$	-	0.60
<b>Concrete Breakout Strength in Shear (ACI 318-14 17.5.2 or ACI 318-11 D.6.2)</b>			
Load bearing length of anchor in shear	$l_e$	in. (mm)	3/4 (19)
Nominal outside anchor diameter	$d_a$	in. (mm)	0.625 (15.9)
Reduction factor for concrete breakout strength	$\phi$	-	0.45
<b>Pryout Strength in Shear (ACI 318-14 17.5.3 or ACI 318-11 D.6.3)</b>			
Coefficient for pryout strength	$k_{cp}$	-	1.0
Effective embedment	$h_{ef}$	in. (mm)	3/4 (19)
Reduction factor, pryout strength	$\phi$	-	0.45

For SI: 1 inch = 25.4 mm, 1 lbf = 0.0044 kN.

- The data in this table is intended to be used with the design provisions of ACI 318-14 Chapter 17 or ACI 318-11 Appendix D, as applicable; for anchors resisting seismic load combinations the additional requirements of ACI 318-17 17.2.3 or ACI 318-11 D.3.3, as applicable shall apply.
- Installation must comply with manufacturer's published installation instructions and details.
- All values of  $\phi$  are applicable with the load combinations of IBC Section 1605.2, ACI 318-14 Section 5.3, or ACI 318-11 Section 9.2.
- The strengths shown in the table are for the Mini-Undercut+ anchors only. Design professional is responsible for checking threaded rod strength in tension, shear, and combined tension and shear, as applicable.
- Reported values for steel strength in shear are based on test results per ACI 355.2, Section 9.4 and must be used for design in lieu of the calculated results using equation 17.5.1.2b of ACI 318-14 or equation D-29 in ACI 318-11 D.6.1.2.
- Reported values for steel strength in shear for the Mini-Undercut+ anchors are for seismic applications and based on test results in accordance with ACI 355.2, Section 9.6 and must be used for design.
- Anchors are permitted to be used in sand-lightweight concrete provided the modification factor  $\lambda_a$  equal to  $0.8\lambda$  is applied to all values of  $\sqrt{f'_c}$  affecting  $N_n$  and  $V_n$ .  $\lambda$  shall be determined in accordance with the corresponding version of ACI 318.

### Steel Design Information for Threaded Rod Elements Used with Mini-Undercut+ Anchors<sup>1,2,3,4</sup>

Design Information		Symbol	Units	3/8-inch
Threaded rod nominal outside diameter		$d_{rod}$	in.	0.375
Threaded rod effective cross-sectional area		$A_{se}$	in. <sup>2</sup>	0.078
Nominal tension strength of threaded rod as governed by steel strength	ASTM A36 or F1554, Grade 36	$N_{sa,rod}$	lb	4,525
Nominal tension strength of threaded rod as governed by steel strength, seismic		$N_{sa,rod,eq}$	lb	4,525
Nominal shear strength of threaded rod as governed by steel strength	ASTM A36 or F1554, Grade 36	$V_{sa,rod}$	lb	2,695
Nominal shear strength of threaded rod as governed by steel strength, seismic		$V_{sa,rod,eq}$	lb	1,900

For SI: 1 inch = 25.4 mm, 1 pound = 0.00445 kN, 1 in<sup>2</sup> = 645.2 mm<sup>2</sup> For pound-inch unit: 1 mm = 0.03937 inches.

- Values provided for steel element material types, or equivalent, based on minimum specified strengths;  $N_{sa,rod}$  and  $V_{sa,rod}$  calculated in accordance with ACI 318-14 Eq. 17.5.1.2a and Eq. 17.5.1.2b or ACI 318-11 Eq. D-28 and Eq. D-29, respectively, as applicable.  $V_{sa,rod,eq}$  must be taken as  $0.7 V_{sa,rod}$ .
- $\phi N_{sa}$  shall be the lower of  $\phi N_{sa,rod}$  or  $\phi N_{sa}$  for static steel strength in tension; for seismic loading  $\phi N_{sa,eq}$  shall be the lower of  $\phi N_{sa,rod,eq}$  or  $\phi N_{sa,eq}$ .
- $\phi V_{sa}$  shall be the lower of  $\phi V_{sa,rod}$  or  $\phi V_{sa}$  for static steel strength in tension; for seismic loading  $\phi V_{sa,eq}$  shall be the lower of  $\phi V_{sa,rod,eq}$  or  $\phi V_{sa,eq}$ .
- Strength reduction factor shall be taken from ACI 318-14 17.3.3 or ACI 318-11 D.4.3, as applicable, for steel elements. Strength reduction factors for load combinations in accordance with ACI 318-14 5.3 or ACI 318-11 9.2, as applicable, governed by steel strength of ductile steel elements shall be taken as 0.75 for tension and 0.65 for shear. The values of  $\phi$  applies when the load combinations of Section 1605.2 of the IBC, ACI 318-14 5.3 or ACI 318-11 9.2, as applicable, are used in accordance with ACI 318-14 17.3.3 or ACI 318-11 D.4.3, as applicable.

**ORDERING INFORMATION**

**Mini-Undercut+**

Cat. No.	Anchor Size	Rod/Anchor Dia.	Drill Diameter	Overall Length	Box Qty.	Ctn. Qty.
PFM2111820	3/8" x 3/4"	3/8"	5/8"	3/4"	100	600

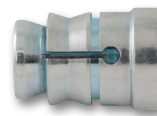

**Accu-Bit™ for DEWALT Mini-Undercut+**

Cat. No.	Accu-Bit Size	Rod/Anchor Dia.	Drill Diameter	Drill Depth	Std. Pack
PPA2431720	5/8" x 3/4" Stop Drill Bit - PT Anchor	3/8"	5/8"	3/4"	1



**SDS Plus Setting Tool for DEWALT Mini-Undercut+**

Cat. No.	SDS Plus Setting Tool Size	Rod/Anchor Dia.	Std. Pack
PFM2101720	3/8" SDS+ Setting Tool - PT Anchor	3/8"	1



**Mini-Undercut+ Ordering Matrix**

Description	Anchor Cat No.	Accu-Bit™ Cat. No.	SDS Plus Setting Tool Cat. No.	Recommended SDS Hammer-Tools (DEWALT)
3/8" x 3/4" Mini-Undercut+	PFM2111820	PPA2431720	PFM2101720	DCH273, DCH133, D25133, D25262, DCH263, D25263

**MECHANICAL ANCHORS**

**MINI-UNDERCUT+™**  
Internally Threaded Undercut Anchor