

west coast engineering ltd

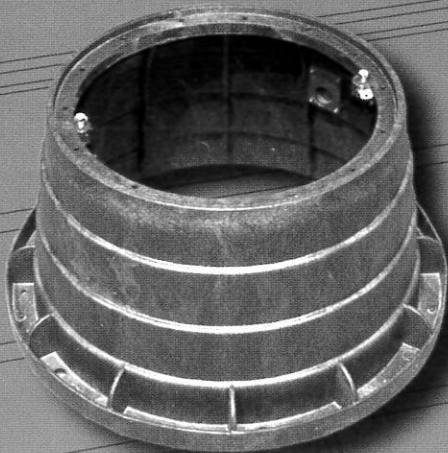

junction boxes



Plastic Underground Electrical Junction Boxes

Large Round • H2O Load

Cat #	Item	Top Dimensions	Bottom Dimensions	Height	Weight
		in (mm)	in (mm)	in (mm)	lbs (kg)
25010	Box	20.87 (530)	28.7 (730)	15.11 (384)	17 (7.7)
25300	Lid - Plastic*	19.69 (500)			6 (2.7)
25310	Lid - Steel	19.69 (500)			34.25 (15.6)
25800	Drain Plate	19.69 (500)			4.75 (2.16)

Notes:

- i) Tested for H2O loading with steel lid.
- ii) BC Ministry of Highways approved.
- iii) Washington State D.O.T. approved.

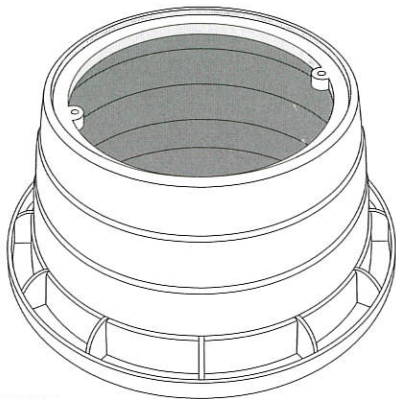

25010

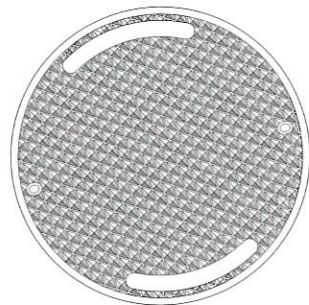

25300



25310



25800

Small Round • H2O Load

Cat #	Item	Top Dimensions	Bottom Dimensions	Height	Weight
		in (mm)	in (mm)	in (mm)	lbs (kg)
25020	Box	14.65 (372)	20 (508)	15.16 (385)	10 (4.55)
25400	Lid - Plastic*	13.66 (347)			2.5 (1.14)
25410	Lid - Steel	13.66 (347)			15.75 (7.2)
25810	Drain Plate	13.66 (347)			2 (0.91)

Notes:

- i) Tested for H2O loading with steel lid.
- ii) BC Ministry of Highways approved.
- iii) Washington State D.O.T. approved.

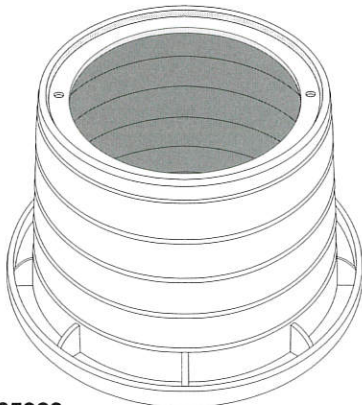

25020

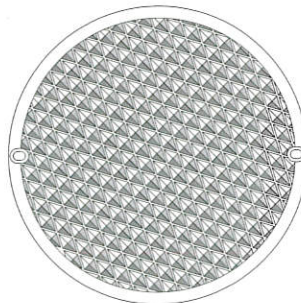

25400

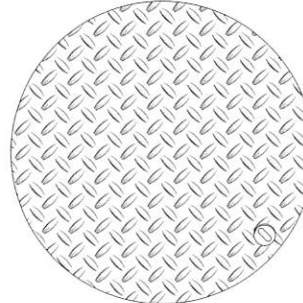

25410

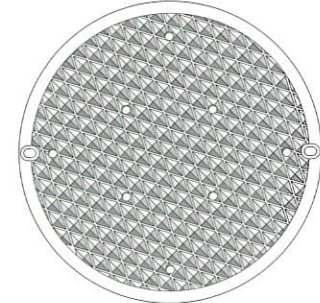

25810

Large Rectangular

Cat #	Item	Top Dimensions	Bottom Dimensions	Height	Weight
		in (mm)	in (mm)	in (mm)	lbs (kg)
25100	Large Rect.	31.6 x 18.5 (802 x 470)	37 x 24 (940 x 610)	15 (381)	20.74 (9.4)
25500	Lid - Plastic*	29.5 x 17.7 (750 x 450)			11.5 (5.2)
25510	Lid - Steel	30.3 x 17.3 (770 x 440)			40.5 (18.4)

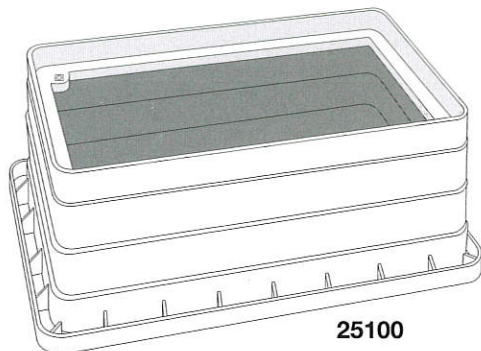

25100

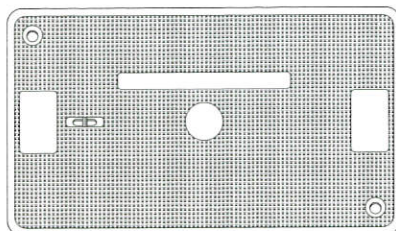

25500

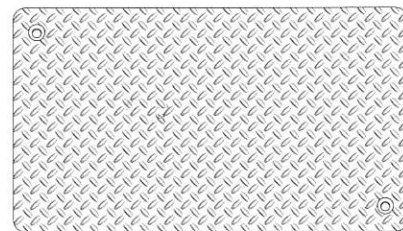

25510

Medium Rectangular

Cat #	Item	Top Dimensions	Bottom Dimensions	Height	Weight
		in (mm)	in (mm)	in (mm)	lbs (kg)
25110	Medium Rect.	26.6 x 14.6 (675 x 372)	34.45 x 22.6 (875 x 575)	15.16 (385)	21.5 (9.8)
25600	Lid - Plastic*	26.6 x 13.6 (675 x 345)			8 (2.7)
25610	Lid - Steel	26.3 x 13.8 (667 x 350)			23.25 (10.6)
25820	Drain Plate	26.6 x 13.6 (675 x 345)			3.25 (1.42)

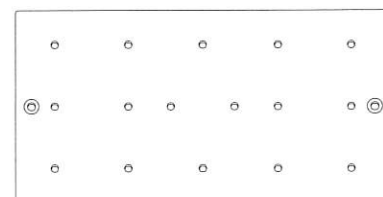

25820

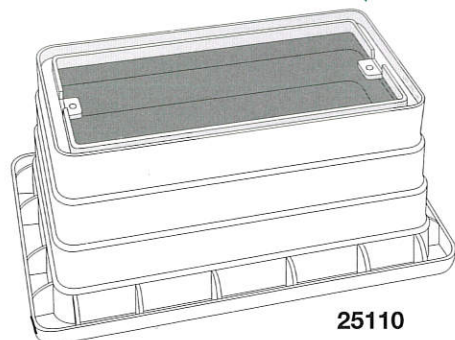

25110

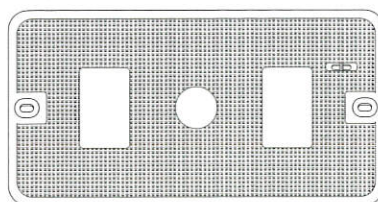

25600

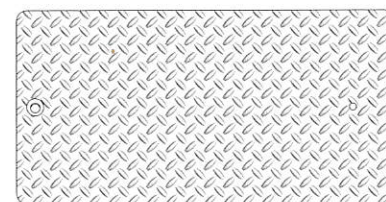

25610

Small Rectangular

Cat #	Item	Top Dimensions	Bottom Dimensions	Height	Weight
		in (mm)	in (mm)	in (mm)	lbs (kg)
25120	Small Rect.	17 x 11.75 (432 x 298)	21.2 x 15.75 (538 x 400)	12 (305)	7.5 (3.4)
25700	Lid - Plastic*	15.3 x 10.1 (389 x 257)			2.5 (1.14)
25710	Lid - Steel	15.2 x 9.9 (387 x 252)			10.75 (4.9)

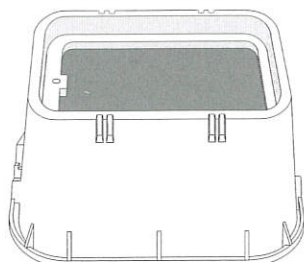

25120

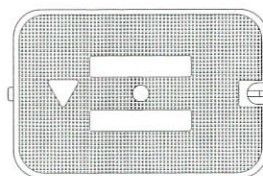

25700

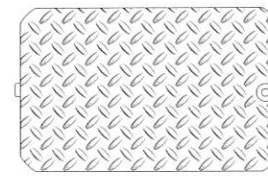

25710