

# Non-illuminated Push Buttons

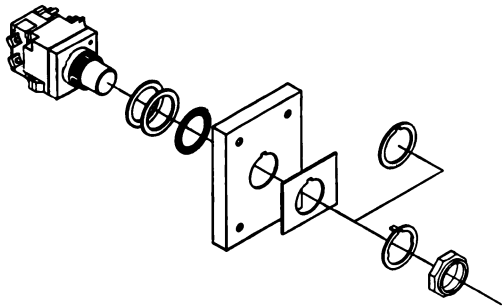

- Push Button Cap**
  - Interchangeable, snap-in design
  - 9 colors: red, black, green, brown, yellow, orange, blue, white, clear
- Mushroom Head**
  - 2 sizes: 1 3/8", 2 3/8"
  - 4 colors: black, red, green, yellow
- Mounting Ring**
  - Interchangeable design allows for flush, recessed or extended style on the same operator
- Contact Blocks**
  - Color coded for quick installation
  - Maximum of 8 single or 4 double contact blocks
  - Visible contacts for easy, accurate inspections
  - Special applications: early close, late open, gold flashed, reed switch

## Accessories for push buttons

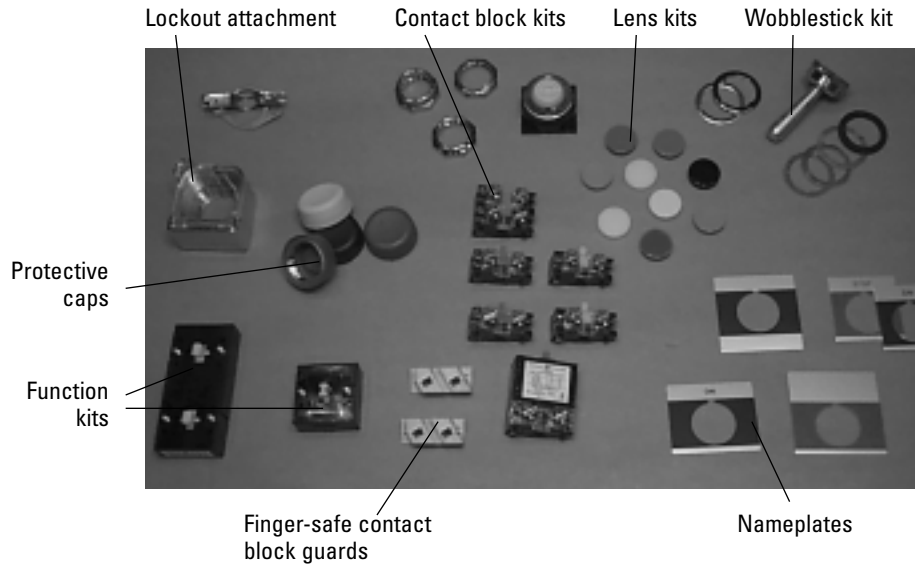

## Accessories for mushroom-head push buttons

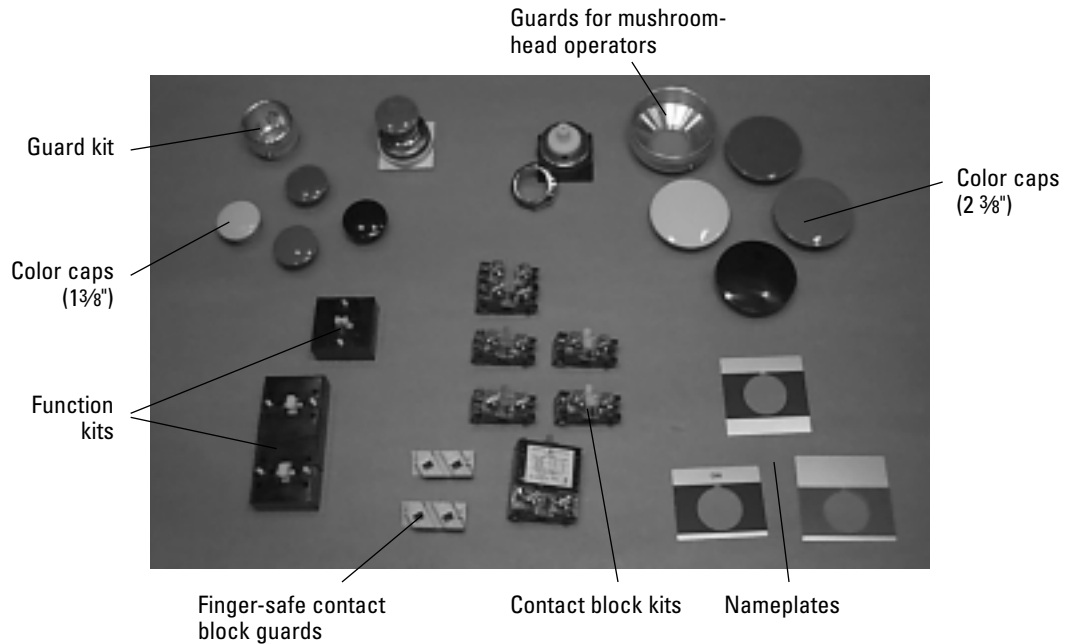

**Non-illuminated Push Buttons**

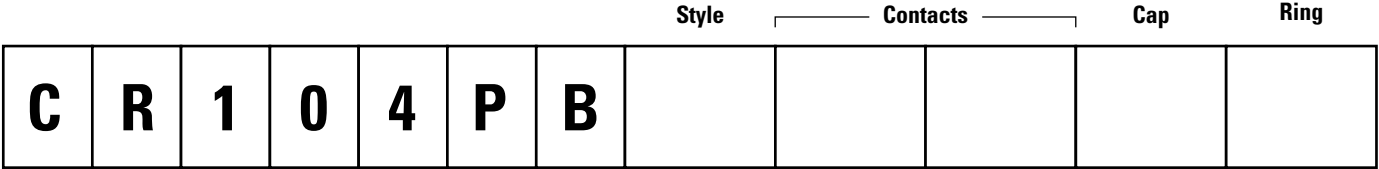

**G** = Standard  
**M** = Mushroom-head

**00** = None  
**01** = 1NC  
**10** = 1NO  
**91** = 1NO/1NC  
**92** = 2NO/2NC

**1** = Flush  
**2** = Extended  
**3** = Recessed  
**5** = 1 3/8" (35mm)  
**6** = 2 3/8" (60mm)

Availability	
Standard	Mushroom-head





Availability	
Standard Push Button	Mushroom-head

**A** = No cap  
**B** = Black  
**C** = Clear  
**E** = Yellow  
**G** = Green  
**L** = Blue  
**M** = Orange  
**N** = Brown  
**R** = Red  
**W** = White

**Other forms available:**

- Push-on, push-off
- Push-pull
- Two push buttons with maintained latch kit
- Two push buttons with mechanical interlock kit
- Wobble stick
- Key-operated push buttons

**Tip for Quick Service:** For small quantities, order operator with color cap universal kit and separate contact blocks. These items are typically in distributor stock (CR104PG00U1,V1). For OEM samples, order above components for field assembly and order any necessary recessed or extended rings separately.

	Joysticks	3-, 5- & 9-position, Momentary & Maintained	CR104PJ...
	Cluster Lights	2- & 4-lamp; 6V, 12V & 24V Full Voltage	CR104PLB... & CR104PLQ...
	Remote Test Lights	Lights All Illuminated Operators	CR104PBL...
	Time Delay Push Buttons	.5- to 30-second Adjustable Delay	CR104PBG99
	Cylinder Lock	Lock Capability in Any Position	CR104PBK...
	Enclosures	Sheet- & Stainless-Steel, 1 to 25 Operators	CR104PE...