

# Areamaster™ 250/400 Integrally Ballasted Floodlights

70 W, 100 W, 150 W, 250 W, 400 W HPS; 175 W, 200 W, 250 W, 320 W, 400 W PSMH.

175 W, 250 W, 400 W MH 

**NEC:** For general, marine and hazardous locations  
Class I, Division 2, Groups A, B, C, D  
Class I, Zone 2, AEx nR, Groups IIA, IIB, IIC

**CEC ** For general, marine and hazardous locations  
Class I, Division 2, Groups A, B, C, D  
Class I, Zone 2, Ex nR, Groups IIA, IIB, IIC  
Class II, Division 1 and 2, Groups E, F, G  
Class III

**NEC/CEC:**  
IP66  
Marine type electric fixtures, outside type (salt water)

## Applications

- Powerful, efficient weatherproof lighting for medium and large areas such as:
  - Shopping malls
  - Parking lots
  - Sports areas
  - New-car lot lighting
  - Security lighting
  - Industrial process lighting

## Features

- Compact in size, attractively styled contemporary design, rugged and dependable.
- Easy to install and service.
- A wide range of ballasts and voltages are available for both domestic and export applications.
- Integral ballast.
- One-piece housing.
- One-piece lens cover. Secured by four 1/4" Dia. captive stainless steel slotted hex-head bolts.
- Thermal shock and impact resistant glass lens.
- Heavy duty, high temperature silicone rubber gasket, firmly seated.
- Heavy duty mogul-base porcelain socket with heavy gauge brass, nickel-plated, double lamp-grip screw shell and spring-loaded center contact.
- Compound parabolic, double segment, finished aluminum reflector for optimum efficiency.
- Mounting choice:
  - (1) Yoke mount, zinc plated steel yoke with architectural bronze polyester finish
  - (2) Pole mount, built-in slip-fitter, for internal wiring, adjustable laterally and vertically, slip fits 2" or 2-1/2" pipe, architectural bronze polyester finish
- Cool operating temperatures translate into long luminaire life.

## Standard Materials

- Ballast housing and lens door: copperfree (4/10 of 1% max.) aluminum
- Gasket: silicone rubber
- Socket: heavy duty porcelain with heavy gauge brass shell
- Reflector: finished aluminum
- Yoke mount: zinc plated steel
- Bolts: stainless steel

## Standard Finishes

- Ballast housing, lens cover, yoke and pole mount: architectural bronze polyester
- Socket: nickel-plated

## Certifications and Compliances

- Areamaster 250/400
  - UL Standard: UL 1598, UL 1598A, UL 844
  - UL Listed: E10794
- Zone 2 Areamaster 250/400
  - UL Standard: UL 1598, UL 1598A, UL 60079-0, UL 60079-15
  - UL Listed: E10794



Projected Area: 1.9 Sq. Ft.

## Dimensions in Inches/Millimeters

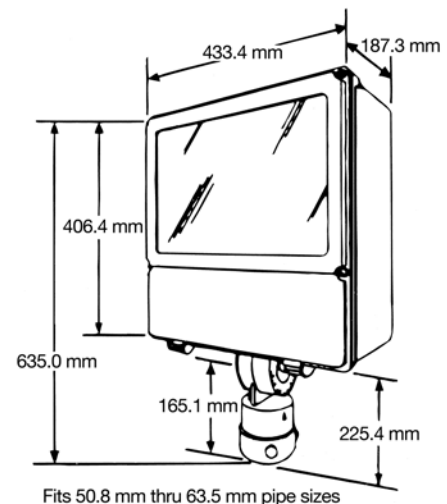

 CSA Certification only.

Visit our website at [www.appletonelec.com](http://www.appletonelec.com) or contact us at (800) 621-1506.  
© September 2010

 **Appleton**

1155







LIGHTING: ENCLOSED AND GASKETED — FLOODLIGHT

Lighting

# Areamaster™ 250/400 Integrally Ballasted Floodlights

70 W, 100 W, 150 W, 250 W, 400 W HPS; 175 W, 200 W, 250 W, 320 W, 400 W PSMH.

175 W, 250 W, 400 W MH 

Dimensions	Description	Catalog Numbers
<b>Crossarm Mounting Bracket</b>		
	Has 180° horizontal adjustment — degree marked. Facilitates mounting floodlight to crossarm or other flat surface, or to G-AM-8-WB. Includes floodlight yoke bolts. Malleable iron, zinc plated, chromate sealed, architectural bronze polyester finish.	<b>G-AM-8-CA</b>
<b>Pipe or Wall Mount Bracket</b>		
	Used with G-AM-8-CA. Clamps to 1" to 2-1/2" pipe, vertical or horizontal, or mounts on flat surfaces. Includes U-bolt and crossarm bracket bolts. Malleable iron, zinc plated, chromate sealed, with architectural bronze polyester finish.	<b>G-AM-8-WB</b>
<b>Poletop Slip-Fitter</b>		
	Slip-fits 1-1/2" or 2" pipe size poletop tenons. Includes floodlight yoke bolts, 3 locking bolts, and cord grip. Body is malleable iron-zinc plated, chromate sealed, with cast aluminum cap. Assembly has architectural bronze polyester finish.	<b>G-SF20</b>
<b>Locking-Type Photocontrol Receptacle</b>		
	For NEMA type photocontrol, with installation hardware and instructions. <b>Should not be mounted on Class I, Division 2/Class 1, Zone 2 units.</b>	<b>G-1PCR</b>
<b>Vandal Shield</b>		
	UV stabilized polycarbonate, with installation hardware and instructions.	<b>G-AM-6-VS</b>
<b>Top Visor</b>		
	Easy to install with hardware supplied. Aluminum, with architectural bronze POLYESTER finish.	<b>G-AM-6-V</b>
<b>Replacement Lens</b>		
		<b>604249003</b>
<b>Replacement Lens Frame Assembly</b>		
	Complete with Lens	<b>59607383002</b>

 CSA Certification only.