

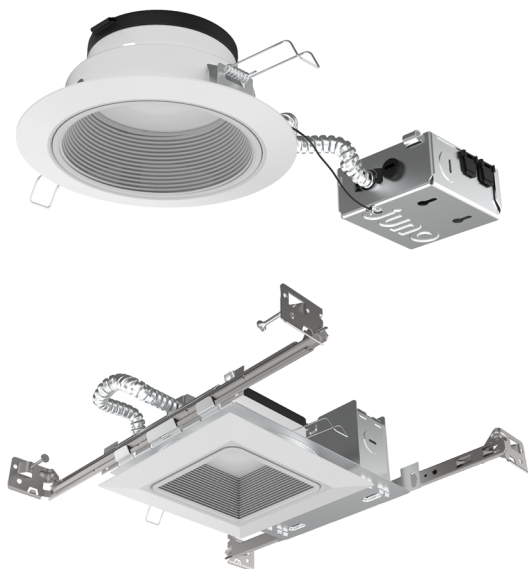

Podz™ LED Downlight Series

5" Canless Round and Square LED Downlight
New Construction or Remodel

JPDZ5 Series



Dimensions

5" Round

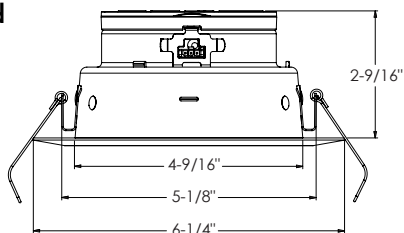

5" Square

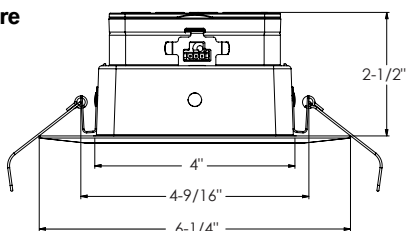

Application Flexibility - Remodel



Application Flexibility - New Construction



Project:
Fixture Type:
Location:
Contact/Phone:

Product Features

Canless low profile 5" LED recessed downlight with deeply regressed light source and technology rich features offers performance up to 1200L and installation solutions for both new construction and remodel applications.

Patent pending integral light engine

- Integrated design offers switchable LED color temperature and adjustable lumen output directly on module for easy switching
- Advanced color mixing technology provides consistent performance on the black body curve at all LED color temperatures while maintaining a high 90+ CRI
- WarmDim™ setting provides performance similar to incandescent light sources and warms the LED color temperature over the dimming range from 2850K to 1900K

Installation flexibility and ease

- Low profile integrated LED downlight less than 3" in height fits virtually anywhere
- Installs directly into the plenum - eliminates need for typical recessed housing
- Installs into new construction or remodel applications

Applications

- Ideal for a breadth of residential and commercial applications
- Shallow plenum installations
- IC rated - for direct contact with insulation
- Wet location listed - for use in shower applications

Performance

Switchable Delivered Lumens	700L, 1000L, 1200L
Switchable LED Color Temperature	27K, 30K, 35K, 40K, 50K
WarmDim Included as standard	2850K - 1900K over dimming range
CRI	90+
Voltage	Dedicated 120V or MVOLT (120-277V)
Dimming	Forward/Reverse Phase or 0-10V



Podz™ LED Downlight Series

5" Canless Round and Square LED Downlight
New Construction or Remodel

ORDERING INFORMATION For complete fixture, order trim module + mounting option

Podz TRIM MODULE

Example: JPDZ5 DC ALO10 SWW5WD 90CRI JPDZRMJBX 120 FRPC WWH

Series	Trim Type	Lumens	Color Temperature	CRI
JPDZ5 Juno Podz 5" LED Downlights	DB Round Downlight Baffle DC Round Downlight Cone SQDB Square Downlight Baffle SQDC Square Downlight Reflector	ALO10 Adjustable Lumen Output 700L, 1000L, and 1200L	SWW5WD Switchable White 2700K, 3000K, 3500K, 4000K, 5000K, + WarmDim (2850K-1900K)	90CRI 90+CRI

Mounting Options	Voltage/Driver	Finish
REMODEL: JPDZRMJBX ⁴ Juno Podz universal remodel junction box (for 4", 5", 6")	120 FRPC 120V Forward/Reverse Phase Cut, 5% dim MVOLT ZT10 Multi-Volt (120-277), 0-10V, 10% dim	WWH ¹ White, White Trim Ring BWH ² Black, White Trim Ring CWH ³ Clear, White Trim Ring HZWH ³ Haze, White Trim Ring WHZWH ³ Wheat Haze, White Trim Ring
NEW CONSTRUCTION: JPDZ5NCMF Juno Podz 5IN New Construction Mounting Frame (For use with Round and Square Trim Modules)		

Square trim options available to order May 2021.

NOTES

- 1 WWH is only available with DB, SQDB, DC and SQDC.
- 2 BWH only available with DB and SQDB.
- 3 CWH, HZWH and WHZWH only available with DC and SQDC.
- 4 Not for use in an existing housing.

Product ships in two parts

Trim Module



Mounting Option

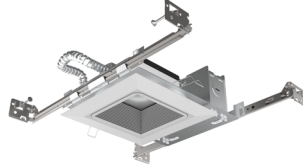

Remodel - Round

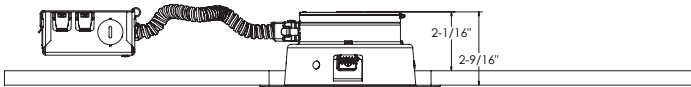

5 5/8" CEILING CUTOUT

Remodel - Square

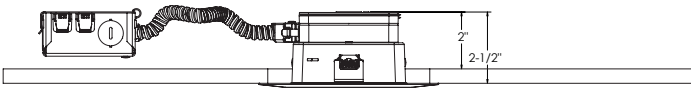

5 5/8" CEILING CUTOUT

New Construction - Round

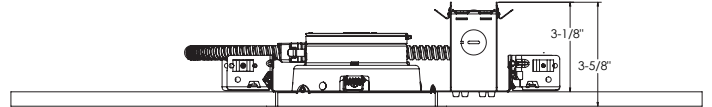

5 5/8" CEILING CUTOUT

New Construction - Square

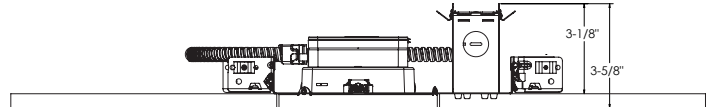

5 5/8" CEILING CUTOUT

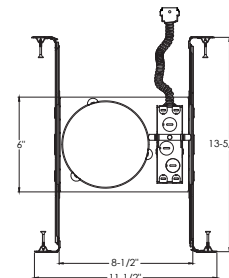
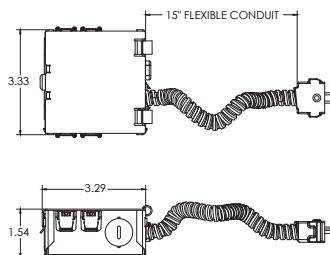



Podz™ LED Downlight Series

5" Canless Round and Square LED Downlight
New Construction or Remodel

Specifications

LED Light Engine

Patent pending integral light engine mounts directly to aluminum housing providing superior heat transfer to ensure long life of the electronics

- Switchable LED color temperature and adjustable lumen output directly on module for easy switching
- Advanced color mixing technology provides consistent color rendering on the black body curve at all LED color temperatures
- LED color temperature settings include 2700K, 3000K, 3500K, 4000K and 5000K; factory set at 3000K
- Three lumen switching options include 700L, 1000L and 1200L; factory set at 1000L
- Dedicated WarmDim setting provides performance similar to incandescent light sources and warms the LED color temperature over the dimming range from 2850K to 1900K
- 90CRI minimum

LED Driver

Choice of dedicated 120 volt (120) driver or universal voltage (MVOLT) drivers that accommodate input voltages from 120-277 volts AC at 50/60Hz

- Power factor > 0.9 at 120V input
- 120 volt only driver is dimmable with the use of most incandescent, magnetic low voltage and electronic low voltage wall box dimmers
- Universal voltage drivers are dimmable with the use of most 0-10V wall box dimmers
- For a list of compatible dimmers, see [JUNOICLED-DIM](#)

Optical System

Computer-optimized reflector design with high reflectance white finish coupled with a high transmission diffusing lens conceals the LEDs and produces uniform aperture luminance

- Deep regression of lens produces a low glare, efficient system typical of a standard 4" downlight medium flood distribution providing even illumination for general downlighting applications.

Certifications

ENERGY STAR® Certified • Can be used to comply with 2019 Title 24, Part 6, JA8 high efficacy LED light source requirements

- UL listed for U.S. and Canada through-branch wiring, damp locations and for wet location (indoor covered ceiling)
- UL and cUL

Testing All reports are based on published industry procedures; field performance may differ from laboratory performance.

Trim Module Construction

Low profile, < 3" aluminum housing with integral white flange

- Designed for installation directly into the plenum in IC (insulated ceiling) or non-IC construction
- Provided with spring clips for ease of installation
- Accommodates up to a 1 1/2" ceiling thickness

Trim Finishes

Choice of baffle or cone trims in a selection of finishes ship installed in trim

Remodel Junction Box Construction

22-gauge die-formed galvanized steel junction box

- Conduit cable with quick connect electrical plug pre-wired on junction box and allows for easy electrical connection with the trim module
- Junction box provided with (5) 1/2" and (1) 3/4" knockouts, (4) integrated wire traps for 12/2 or 12/3 NM cable
- UL listed and cUL listed for through-branch wiring, maximum of 4 #12 branch circuit

New Construction Mounting Frame

22-gauge die-formed galvanized steel mounting frame

- Rough-in section (junction box, mounting frame and bar hangers) fully assembled for ease of installation
- Pre-installed Air-Loc gasket applied to frame
- Conduit cable with quick connect electrical plug pre-wired on junction box and allows for easy electrical connection with the trim module
- Junction box provided with (5) 1/2" and (1) 3/4" knockouts, (4) knockouts for 12/2 or 12/3 NM cable and ground wire
- UL listed and cUL listed for through-branch wiring, maximum of 6 #12 branch circuit conductors
- Junction box provided with removable access plates
- Knock-outs equipped with pryout slots

Includes Patented (US Patent D552,969) Real Nail® 3 bar hangers: telescoping system permits quick placement of housing any where within 24" O.C. joists or suspended ceilings

- Includes removable nail for repositioning of fixture in wood joist construction
- Integral T-bar notch and clip for suspended ceilings.

LED housing is designed to provide 50,000 hours of life

- 5 year limited warranty on LED components.

Note: Actual performance may differ as a result of end-user environment and application.

All values are design or typical values, measured under laboratory conditions at 25 °C.

Specifications subject to change without notice.

ELECTRICAL DATA

Dedicated 120V Only Driver Option (120 FRPC)

	700L	1000L	1200L
Input Power	7.5W (+/-5%)	12.6W (+/-5%)	15.1W (+/-5%)
Input Current	0.06A	0.11A	0.13A
Frequency	50/60Hz	50/60Hz	50/60Hz
EMI/RFI	FCC Title 47 CFR, Part 15, Class B (residential)	FCC Title 47 CFR, Part 15, Class B (residential)	FCC Title 47 CFR, Part 15, Class B (residential)
Minimum starting temp	-20°C	-20°C	-20°C

ELECTRICAL DATA

Universal Voltage

MVOLT ZT10

	700L		1000L		1200L	
	120V	277V	120V	277V	120V	277V
Input Power	7.5W (+/-5%)	7.5W (+/-5%)	12.6W (+/-5%)	12.6W (+/-5%)	15.1W (+/-5%)	15.1W (+/-5%)
Input Current	0.06A	0.03A	0.11A	0.05A	0.13A	0.07A
Frequency	50/60Hz	50/60Hz	50/60Hz	50/60Hz	50/60Hz	50/60Hz
EMI/RFI	FCC Title 47 CFR, Part 15, Class B (residential)	FCC Title 47 CFR, Part 15, Class B (residential)	FCC Title 47 CFR, Part 15, Class B (residential)	FCC Title 47 CFR, Part 15, Class B (residential)	FCC Title 47 CFR, Part 15, Class B (residential)	FCC Title 47 CFR, Part 15, Class B (residential)
Minimum starting temp	-20°C	-20°C	-20°C	-20°C	-20°C	-20°C