

Threaded products and hardware

Channel nuts

Superstrut channel nuts are manufactured from grade 2 mild steel and are case hardened.

Design data

Superstrut self-aligning channel nuts are designed to provide resistance to pullout and resistance to side slip in excess of the full strength of the channels with which they are used. The extreme resistance to side slip results from the unique design of the alternate teeth, spaced and designed to develop a wedging action that increases with pressure or load.

Screw threads

All threaded products are American Standard thread, free fit class 2.

| Thread size (in.) | ¼ | ⅜ | ½ | ¾ | 1 | 1 ¼ | 1 ½ | 2 |
|------------------------|----|----|----|----|-----|-----|-----|-----|
| Threads per inch | 20 | 18 | 16 | 13 | 11 | 10 | 9 | 8 |
| Design torque (ft.-lb) | 6 | 11 | 19 | 50 | 100 | 125 | 185 | 275 |

Finish and special materials

Standard finish for all hardware is electrogalvanized (EGC) or GoldGalv®. Stainless steel type 316 is also available. Contact your regional sales office for availability and minimum quantities.

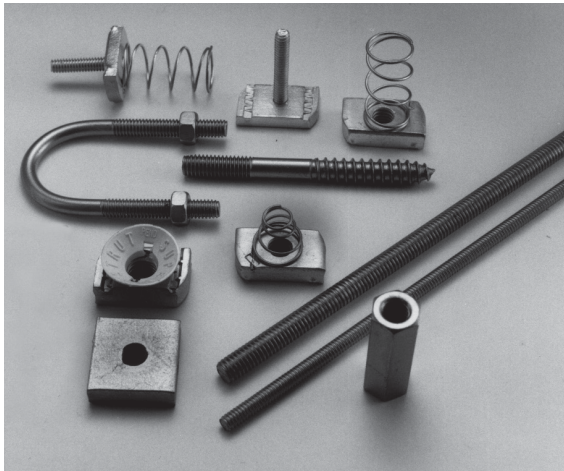

Spring nut selector chart

| Spring nut | Channel series | | | | | |
|--------------|----------------|------|---|---|---|---|
| | A-AR | B-BR | C | D | E | H |
| A100-1/4EGC | ■ | | ■ | | | |
| A100-5/16EGC | ■ | | ■ | | | |
| A100-3/8EGC | ■ | | ■ | | | |
| A100-1/2EGC | ■ | | ■ | | | |
| A100-3/4 | ■ | | ■ | | | |
| B100-1/4EGC | | ■ | | ■ | | |
| B100-5/16EGC | | ■ | | ■ | | |
| B100-3/8EGC | | ■ | | ■ | | |
| B100-1/2EGC | | ■ | | ■ | | |
| H100-3/8EGC | | | | | ■ | ■ |
| H100-1/2EGC | | | | | ■ | ■ |
| CM100-1/4 | ■ | ■ | ■ | ■ | ■ | ■ |
| CM100-3/8 | ■ | ■ | ■ | ■ | ■ | ■ |
| CM100-1/2 | ■ | ■ | ■ | ■ | ■ | ■ |
| CM100-1/2B | | ■ | | | | |
| UC100-1/4 | ■ | ■ | ■ | ■ | ■ | ■ |
| UC100-3/8 | ■ | ■ | ■ | ■ | ■ | ■ |
| UC100-1/2 | ■ | ■ | ■ | ■ | ■ | ■ |

Threaded products and hardware

A100 Regular spring nut*

Std. pack 100

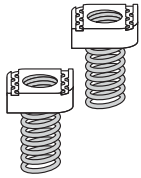

| | Cat. No. | Size (in.) | Wt./C lb |
|--|--------------|------------|----------|
| | A100-1/4EGC | ¼ | 8 |
| | A100-5/16EGC | 5/16 | 9 |
| | A100-3/8EGC | 3/8 | 10 |
| | A100-1/2EGC | ½ | 12 |
| | A100-5/8EGC | 5/8 | 19 |
| | A100-3/4 | ¾ | 19 |
| | A100-7/8 | 7/8 | 18 |

Available in stainless steel 316. Nut is square over ½ in. size.
For all A and C series channel and inserts.

AB100 Springless nut ¼ in. thick

Std. pack 100

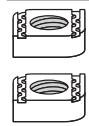

| | Cat. no. | Size (in.) | Wt./C lb |
|--|---------------|------------|----------|
| | AB100-1/4EGC | ¼ | 7 |
| | AB100-5/16EGC | 5/16 | 8 |
| | AB100-3/8EGC | 3/8 | 9 |
| | AB100-1/2EG | ½ | 9 |
| | AB100-5/8EG | 5/8 | 10 |
| | AB100-3/4EG | ¾ | 10 |

For use with all channels. Nut is square over ½ in. size.

H100 Long spring nut*

Std. pack 100

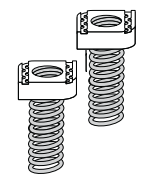

| | Cat. no. | Size (in.) | Wt./C lb |
|--|-------------|------------|----------|
| | H100-3/8EGC | 3/8 | 10 |
| | H100-1/2EGC | ½ | 14 |

For all E and H series channel and inserts.

A182 to A185 Regular spring stud nut*

Std. pack 100

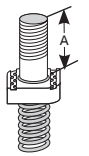

| | Cat. no. | Bolt dia (in.) | Length A (in.) | Wt./C lb |
|---------|----------------|----------------|----------------|----------|
| Diagram | A182-1/4x100EG | ¼ | 1 | 10 |
| | A182-1/4x125EG | ¼ | 1¼ | 15 |
| | A184-3/8x100EG | 3/8 | 1 | 10 |
| | A184-3/8x125EG | 3/8 | 1¼ | 15 |
| | A185-1/2x100EG | ½ | 1 | 10 |
| | A185-1/2x125EG | ½ | 1¼ | 15 |

For all A and C series channels.

B100 Short spring nut*

Std. pack 100

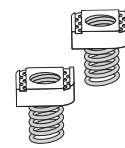

| | Cat. no. | Size (in.) | Wt./C lb |
|--|--------------|------------|----------|
| | B100-1/4EGC | ¼ | 7 |
| | B100-5/16EGC | 5/16 | 8 |
| | B100-3/8EGC | 3/8 | 9 |
| | B100-1/2EGC | ½ | 9 |

Available in stainless steel 316.
For all B and D series channel and inserts.

AC100 Springless nut heavy-duty 3/8 in. thick

Std. pack 100

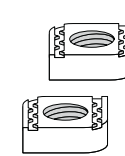

| | Cat. no. | Size (in.) | Wt./C lb |
|--|--------------|------------|----------|
| | AC100-3/8EGC | 3/8 | 9 |
| | AC100-1/2EGC | ½ | 11 |
| | AC100-5/8EGC | 5/8 | 18 |
| | AC100-3/4EGC | ¾ | 18 |

For all A, C, E and H series channel and inserts.
Nut is square over ½ in. size.

A177 to A179 Springless stud nut

Std. pack 100

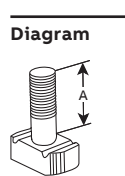

| | Cat. no. | Bolt dia (in.) | Length A (in.) | Wt./C lb |
|---------|----------------|----------------|----------------|----------|
| Diagram | A177-1/4x100EG | ¼ | 1 | 8 |
| | A177-1/4x125EG | ¼ | 1¼ | 10 |
| | A179-3/8x100EG | 3/8 | 1 | 13 |
| | A179-3/8x125EG | 3/8 | 1¼ | 13.5 |

For use with all channels.

813EG Springless nut light-duty

Std. pack 100

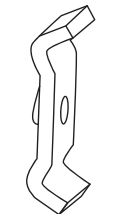

| | Cat. no. | Size (in.) | Wt./C lb |
|--|----------|------------|----------|
| | 813EG | ¼ | 5 |

For use with all channels.

*Supplied with a plastic sleeve over the spring portion to prevent tangling inside the carton.

Threaded products and hardware

E145 Standard hex nut

Std. pack 100

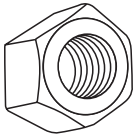

| Cat. no. | Size (in.) | Wt./C lb |
|-------------|------------|----------|
| E145-1/4EGC | 1/4 | .72 |
| E145-3/8EGC | 3/8 | 1.60 |
| E145-1/2EGC | 1/2 | 2.78 |
| E145-5/8EG | 5/8 | 6.92 |
| E145-3/4EGC | 3/4 | 12.70 |
| E145-7/8EGC | 7/8 | 19.00 |
| E145-1EGC | 1 | 28.00 |

812 Stud nut

Std. pack 100

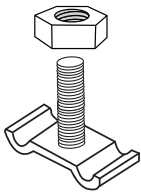

| Cat. no. | Size (in.) | Wt./C lb |
|----------|------------|----------|
| 812-1EG | 1/4 x 1 | 6 |

For attaching fixture to channel slot down or to channel slot up knockouts. Specify length. Hex nut included.

UCN Universal nylon cone nut

Std. pack 100

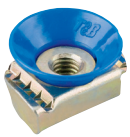

| Cat. no. | Size (in.) | Wt./C lb |
|----------|------------|----------|
| UCN-1/4 | 1/4 | 8 |
| UCN-3/8 | 3/8 | 10 |
| UCN-1/2 | 1/2 | 12 |

GoldGalv® only

For all 1 1/8 in. and 1 1/2 in. channels.

May be used with ALL strut depths.

Can be used for A100 series, B100 series and AB100 series.

E147 Flat steel washer

Std. pack 100

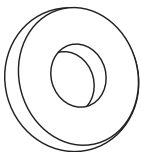

| Cat. no. | Size (in.) | Wt./C lb |
|-------------|------------|----------|
| E147-1/4EG | 1/4 | 0.67 |
| E147-5/16EG | 5/16 | 1.11 |
| E147-3/8EG | 3/8 | 1.49 |
| E147-1/2EG | 1/2 | 3.85 |
| E147-5/8EG | 5/8 | 7.69 |
| E147-3/4EG | 3/4 | 9.89 |
| E147-7/8EG | 7/8 | 15.40 |

Available in stainless steel.

ES145 Swivel nut and jam nut combinations

Std. pack 100

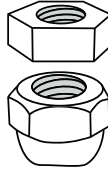

| Cat. no. | Size (in.) | Wt./C lb |
|-----------|------------|----------|
| ES145-3/8 | 3/8 | 5.5 |
| ES145-1/2 | 1/2 | 6.0 |

AB102 Unhardened square nut

Std. pack 100

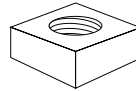

| Cat. no. | Size (in.) | Wt./C lb |
|-----------|------------|----------|
| AB102-1/4 | 1/4 | 13 |
| AB102-3/8 | 3/8 | 14 |
| AB102-1/2 | 1/2 | 14 |
| AB102-5/8 | 5/8 | 12 |
| AB102-3/4 | 3/4 | 11 |
| AB102-7/8 | 7/8 | 10 |

E146 Standard square nut

Std. pack 100

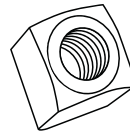

| Cat. no. | Size (in.) | Wt./C lb |
|-------------|------------|----------|
| E146-1/4EG | 1/4 | .93 |
| E146-5/16EG | 5/16 | 1.60 |
| E146-3/8EGC | 3/8 | 2.65 |
| E146-1/2EG | 1/2 | 5.83 |
| E146-5/8EG | 5/8 | 10.80 |

EF147 Fender washer

Std. pack 100

| Cat. no. | Size (in.) | A (in.) | B (in.) | Wt./C lb |
|--------------|------------|---------|---------|----------|
| EF147-1/4EGC | 1/4 | 1 1/4 | 5/16 | 3.1 |
| EF147-3/8EGC | 3/8 | 1 1/2 | 7/16 | 2.9 |
| EF147-1/2EGC | 1/2 | 2 | 9/16 | 5.0 |

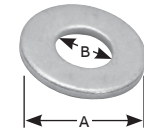

Available in stainless steel.

E148 Lock washer

Std. pack 100



| Cat. no. | Size (in.) | Wt./C lb |
|------------|------------|----------|
| E148-1/4EG | 1/4 | 0.26 |
| E148-3/8EG | 3/8 | 0.50 |
| E148-1/2EG | 1/2 | 1.09 |
| E148-5/8EG | 5/8 | 2.57 |

Available in stainless steel.

Threaded products and hardware

E142 Hex head cap screw

Std. pack 100



| Cat. no. | Size (in.) | Wt./C lb |
|----------------|------------|----------|
| E142-1/4x100EG | ¼ x 1 | 1.74 |
| E142-1/4x150EG | ¼ x 1½ | 2.43 |
| E142-3/8x100EG | ⅜ x 1 | 4.17 |
| E142-3/8x150EG | ⅜ x 1½ | 5.64 |
| E142-1/2x100EG | ½ x 1 | 8.94 |
| E142-1/2x150EG | ½ x 1½ | 10.00 |
| E142-1/2x200EG | ½ x 2 | 11.19 |
| E142-1/2x225EG | ½ x 2¼ | 11.90 |
| E142-1/2x250EG | ½ x 2½ | 12.52 |
| E142-1/2x275EG | ½ x 2¾ | 13.22 |

Available in stainless steel.

E151 Coach screw rod



| Cat. no. | Rod size (in.) | Std rod length (in.) | Wt./C lb |
|---------------|----------------|----------------------|----------|
| E151-3/8x4EG | ⅜ | 4 | 9 |
| E151-3/8x6EG | ⅜ | 6 | 14 |
| E151-3/8x8EG | ⅜ | 8 | 22 |
| E151-3/8x10EG | ⅜ | 10 | 29 |
| E151-3/8x12EG | ⅜ | 12 | 35 |
| E151-1/2x4EG | ½ | 4 | 17 |
| E151-1/2x6EG | ½ | 6 | 22 |
| E151-1/2x8EG | ½ | 8 | 40 |
| E151-1/2x10EG | ½ | 10 | 51 |

Machine threaded opposite end, carbon steel.

E150S Lag bolt

Std. pack 50

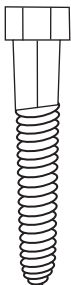

| Cat. no. | Drill size (in.) | Size (in.) | Wt./C lb |
|-------------------|------------------|------------|----------|
| E150S-3/8x1-1/2EG | ¼ | ⅜ x 1½ | 5 |
| E150S-3/8x2EG | ¼ | ⅜ x 2 | 7 |
| E150S-3/8x2-1/2EG | ¼ | ⅜ x 2½ | 8 |
| E150S-3/8x3EG | ¼ | ⅜ x 3 | 9 |
| E150S-1/2x1-1/2EG | 11/32 | ½ x 1½ | 12 |
| E150S-1/2x2EG | 11/32 | ½ x 2 | 13 |
| E150S-1/2x2-1/2EG | 11/32 | ½ x 2½ | 15 |
| E150S-1/2x3EG | 11/32 | ½ x 3 | 18 |

H104 Hanger rod continuous threaded

Std. pack 3

- Black available upon request
- Sold per foot; standard length, 10 ft.
- Also available in stainless steel (316) standard length 6 ft. (suffix SS6)
- National coarse thread

| Cat. no. | Thread size (in.) | Wt./lb 100 ft. | Design Load lb |
|----------------|-------------------|----------------|----------------|
| H104-1/4x10EGC | ¼ | 12.5 | 150 |
| H104-3/8x10EGC | ⅜ | 29 | 610 |
| H104-1/2x10EGC | ½ | 53.5 | 1,130 |
| H104-5/8x10EGC | ⅝ | 85 | 1,810 |
| H104-3/4x10EGC | ¾ | 123 | 2,710 |
| H104-7/8x10EG | 7/8 | 130 | 3,770 |
| H104-1x10EG | 1 | 214 | 4,960 |

H119 Rod couplings – standard

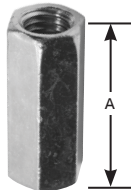
| Diagram | Rod size | A (in.) | Wt./C lb |
|---|----------|---------|----------|
|  | ¼ | 7/8 | 1.90 |
| | 5/16 | 7/8 | 3.75 |
| | 3/8 | 1 1/8 | 3.50 |
| | 1/2 | 1 1/4 | 5.50 |
| | 5/8 | 2 1/8 | 18.00 |
| | 3/4 | 2 1/4 | 28.00 |
| | 7/8 | 2 1/2 | 55.00 |
| | 1 | 2 3/4 | 56.00 |

Standard rod coupling

Example: H119-1/2EG

Order by product number, rod size, and finish.
Available in stainless steel.

H119 Rod couplings – reducing

| Rod size | A (in.) | Wt./C lb |
|----------|---------|----------|
| ¼ to ⅜ | 1½ | 3.50 |
| ⅜ to ½ | 1¾ | 6.70 |
| ½ to ⅝ | 1¾ | 14.00 |
| ⅝ to ¾ | 1½ | 21.00 |
| ¾ to 7/8 | 1¾ | 40.00 |

Rod reducer coupling

Example: H119-1/4x3/8EG

Threaded products and hardware

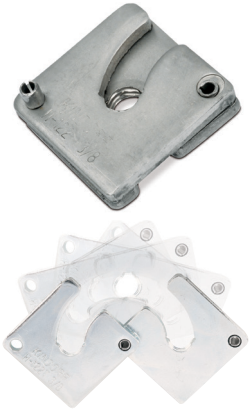

H122 Trapnut™ strut fastener

| Cat. no. | Size (in.) | Design load (lb) | Std. ctn. |
|---------------|------------|------------------|-----------|
| H 122 1/4 | 1/4 | 150 | 50 |
| H 122 3/8 | 3/8 | 590 | 50 |
| H 122 1/2 | 1/2 | 1,080 | 50 |
| H 122 1/4 EG | 1/4 | 150 | 50 |
| H 122 3/8 EG | 3/8 | 590 | 50 |
| H 122 1/2 EG | 1/2 | 1,080 | 50 |
| H 122 3/8 SS6 | 3/8 | 590 | 50 |
| H 122 1/2 SS6 | 1/2 | 1,080 | 50 |

Finishes – Electrogalvanized (EG), GoldGalv®, stainless steel type 316 (SS6)

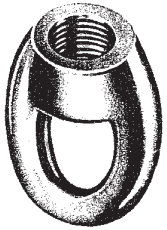

M117 Eye socket

| | Rod size A (in.) | Pipe size (in.) | B (in.) | E (in.) | Wt./C lb | Design load, lb |
|---------|---------------------|-----------------|---------|---------|----------|--------------------|
| Diagram | 1/4 | 3/8 | 1/4 | 1 11/32 | 5 | 230 |
| | 3/8 | 1/2–2 | 1/4 | 1 11/32 | 7 | 610 |
| | 1/2 | 2 1/2–3 1/2 | 1/4 | 1 17/32 | 13 | 1,130 |
| | 5/8 | 4–5 | 3/8 | 1 13/16 | 19 | 1,810 |
| | 3/4 | 6 | 1/2 | 2 5/32 | 31 | 2,400 |
| | 7/8 | 8 | 1/2 | 2 11/32 | 44 | 2,800 |

Standard finishes – bare (B), electrogalvanized (EG)
 Malleable iron. For attaching hanger rod to various types of hangers and beam clamps.
 Order by product number, rod size, and finish. **Example: M117-1/4B**
 Complies with Specification MSS SP69, Type 16.

E120 Swivel joint

| | Cat. no. | Size (in.) | A (in.) | B (in.) | Wt./C lb | Design load, lb |
|---------|----------|------------|---------|---------|----------|--------------------|
| Diagram | E120-3/8 | 3/8 | 1 3/8 | 3/8 | 15 | 1,000 |
| | E120-1/2 | 1/2 | 1 1/2 | 1/2 | 25 | 1,800 |

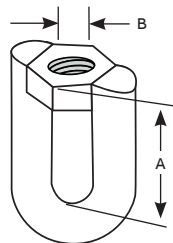

Threaded products and hardware

E120A Weldless eye nut

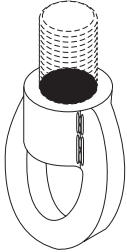

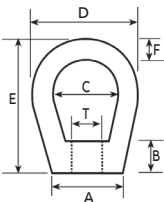
| | Rod size T (in.) | A (in.) | B (in.) | C (in.) | D (in.) | E (in.) | F (in.) | Wt./C lb | Design load, lb |
|---|---------------------|---------|---------|---------|---------|---------|---------|----------|-----------------|
| Diagram | 3/8 | 7/8 | 5/8 | 1 1/4 | 2 | 2 1/2 | 3/8 | 20 | 2,700 |
|  | 1/2 | 7/8 | 5/8 | 1 1/4 | 2 | 2 1/2 | 3/8 | 22 | 2,700 |
| | 5/8 | 1 3/8 | 3/4 | 1 1/2 | 2 1/2 | 3 | 1/2 | 60 | 5,000 |
| | 3/4 | 1 3/8 | 3/4 | 1 1/2 | 2 1/2 | 3 | 1/2 | 56 | 5,000 |
| | 7/8 | 1 1/2 | 1 5/8 | 1 5/16 | 3 5/8 | 4 1/2 | 3/4 | 174 | 10,000 |
| | 1 | 1 1/2 | 1 5/8 | 1 5/16 | 3 5/8 | 4 1/2 | 3/4 | 168 | 10,000 |

Standard finish – bare (B)
 Drop forged steel. For use on high temperature piping installations.
 Order by product number and rod size. **Example: E120A-3/8B**

E122 Swivel joint

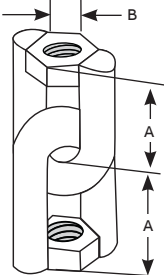
| | Cat. no. | Size (in.) | A (in.) | B (in.) | Wt./C lb | Design load, lb |
|---|----------|------------|---------|---------|----------|-----------------|
| Diagram | E122-3/8 | 3/8 | 1 3/8 | 3/8 | 28 | 1,000 |
|  | E122-1/2 | 1/2 | 1 1/2 | 1/2 | 48 | 1,800 |

E130 Swivel joint

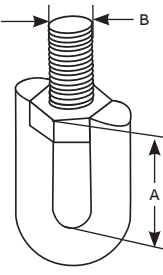
| | Cat. no. | Size (in.) | A (in.) | B (in.) | Wt./C lb | Design load, lb |
|--|----------|------------|---------|---------|----------|-----------------|
| Diagram | E130-3/8 | 3/8 | 1 3/8 | 3/8 | 23 | 1,000 |
|  | E130-1/2 | 1/2 | 1 1/2 | 1/2 | 48 | 1,800 |

E131 Swivel joint

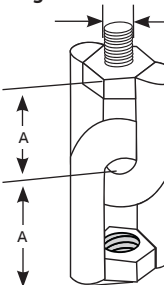
| | Cat. no. | Size (in.) | A (in.) | B (in.) | Wt./C lb | Design load, lb |
|---|----------|------------|---------|---------|----------|-----------------|
| Diagram | E131-3/8 | 3/8 | 1 3/8 | 3/8 | 25 | 1,000 |
|  | E131-1/2 | 1/2 | 1 1/2 | 1/2 | 52 | 1,800 |

Threaded products and hardware

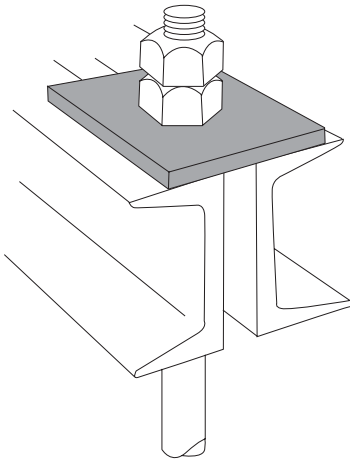

C781 Square washer
Std. pack 50

| Cat. no. | Rod size (in.) | Hole size (in.) | Overall dimensions (in.) | Wt./C lb |
|-----------|----------------|-----------------|--------------------------|----------|
| C781-3/8* | 3/8 | 7/16 | 3 x 3 x 3/16 | 27 |
| C781-1/2* | 1/2 | 9/16 | 3 x 3 x 3/16 | 27 |
| C781-5/8* | 5/8 | 11/16 | 3 x 3 x 1/4 | 47 |
| C781-3/4* | 3/4 | 13/16 | 3 x 3 x 1/4 | 42 |
| C781-7/8* | 7/8 | 15/16 | 4 x 4 x 3/8 | 85 |
| C781-1* | 1 | 1 1/8 | 4 x 4 x 3/8 | 160 |

Used for beam applications. For channel applications, use AB241.

*Finishes

- B
- HDG
- EG
- SS6