

Individual Spec Sheet

FLEXLED LED MODULE

ORDERING INFORMATION

Order code: 63222
Model number: LED/MOD/11.8W/30K/STD
UPC: 069549632226
Case quantity: 48

PHYSICAL DATA

Dimensions: 1 15/32" (37.0 mm)
Shape: Module
Finish: Black

PERFORMANCE DATA

Watts (W): 11.8
Volts (VAC): 120
Colour temperature (K): 3 000
Lumen output (lm): 750
Lumen per Watts (lm/W): 64
CRI: 90
Life L70 (h): 50 000
Beam angle (°): 88
CBCP (cd): N/A
THD (%): <20
Power factor: >0.9
Dimming:
Operating temp. range: -20 °C to 40 °C (-4 °F to 104 °F)

¹ Typical colour temperature range: +/- 5 %

² Lumen values are derived from photometric testing. Initial lumens range: +/- 10 %

³ Life hours are derived from IESNA LM80-08 testing report and projected per IESNA TM-21-11 extrapolations

COMPATIBLE DIMMERS

Brand	Model
LUTRON	AYLV-600P, DV600P, DVELV303P, DV603P, DVCL-153P, FAELV500, LG600P, MAW600, MAELV600, MAEL-153M, RRD-6NA, S-603PG, S600P, SELV300P, SCL-153P, CT103P, TG-603PGH, TGCL-153P
LEGRAND	ADPD703TU, H703PTU, HCL453P
COOPER	DAL06P, DLC03P, SLC03P
LEVITON	IP106-7LZ, 6673-10W, 6631-2, IPE4, 6633-P, 6161, 6615, 6621-P, 6683-IW, VPE06, VP106
CRESTON	CLS-EXP-DIMU, DIN-1DIM4, GLX-DIM6, GLXX-2DIM8
LIGHTOLIER	MSP300QE, ZP260QE

NOTE: The above table shows dimmers that have been tested and have demonstrated proper operation under normal conditions. Each installation being unique, various factors such as load, common neutrals or other electrical products on the circuit can, in certain instances, cause variance in system performance. Read and comply to the dimmer installation instructions. Consult dimming system manufacturer for additional support in operation. Stanpro recommends to use dimmers designed to work with LED products. Older dimmers designed for incandescent products may cause erratic operation. Some dimmers may require more than one product for stable operation. The maximum number of products is determined by the dimmer wattage rating with LEDs. Be careful, these dimmers have different ratings depending on the product type. Again, refer to the dimmer installation instructions.



COMPATIBLE PRODUCTS

Order code	Description
63275	4" trim
63276	4" trim
63277	4" trim
63278	4" trim
63279	4" trim
63290	4" trim
63291	4" trim
63292	6" trims
63293	6" trims
63294	6" trims

Order code	Description
63295	6" trims
63779	4" trim
63780	4" trim
63308	Surface mount
63309	Surface mount
63310	Universal Mounting Housing
63311	4" Remodeler Housing
63480	4" New Construction Housing

DIMENSIONS

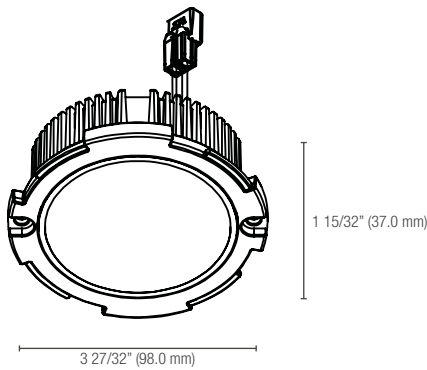

CAUTIONS

- Turn power off before inspection, installation, or removal.
- Risk of electric shock – do not use where directly exposed to water or weather.
- Suitable for use in open fixtures.
- Suitable for use in wet locations.
- Do not open – no user serviceable parts inside.
- Added weight of the device may cause instability of a freestanding portable luminaire. Use in portable table lamps in which the distance from the bottom of the base to the top of the lampholder does not exceed three (3) times the minimum base diameter.
- Use only on 120 VAC, 60 Hz circuits.
- This device is not intended for use with emergency exit fixtures or emergency exit lights.
- Compatible with most dimmers.
- Five year limited warranty.
- For complete dimmer compatibility and warranty information visit www.standardpro.com.
- Operating temperature: -40 °C/-40 °F to 40 °C/104 °F.

PHOTOMETRIC DATA¹

63222 • LED/MOD/11.8W/30K/STD • 799.6 lm

Polar candela distribution

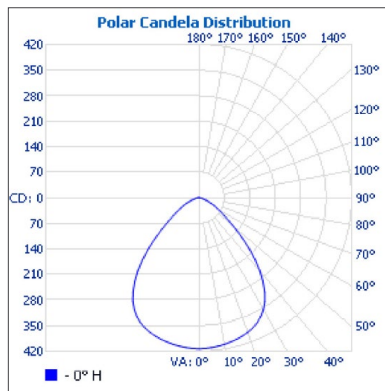

Zonal lumen summary

Zone	Lumens	% Fixture
0-30	325.8	40.8%
0-40	520.8	65.1%
0-60	749.4	93.7%
60-90	50.2	6.3%
70-100	13.3	1.7%
90-120	0	0%
0-90	799.6	100%
90-180	0	0%
0-180	799.6	100%

Illuminance at a distance

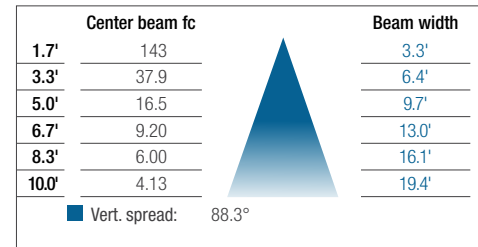

¹ Complete IES files available on our website.

Qty	Description	Price

I accept the specifications of the luminaire configuration mentioned above.

Name: _____
 Company: _____
 Signature: _____

Date: _____

Data is based upon tests performed in a controlled environment. Actual performance can vary depending on operating conditions. All products are subject to change or may be discontinued any time without notice.