

FACE VIEW - FEMALE INSERT SCALE 2 : 1

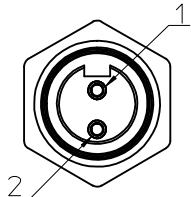

1 WHITE
2 BLACK

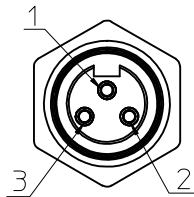

1 GREEN/YELLOW
2 BLACK
3 WHITE

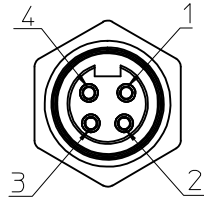

1 BLACK
2 WHITE
3 RED
4 GREEN/YELLOW

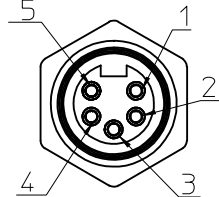

1 WHITE
2 RED
3 GREEN/YELLOW
4 ORANGE
5 BLACK

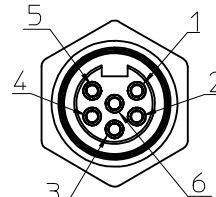

1 WHITE
2 RED
3 GREEN/YELLOW
4 ORANGE
5 BLACK
6 BLUE

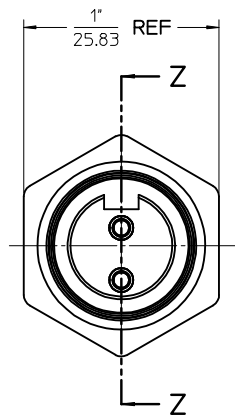

FEMALE INSERT - FRONT VIEW

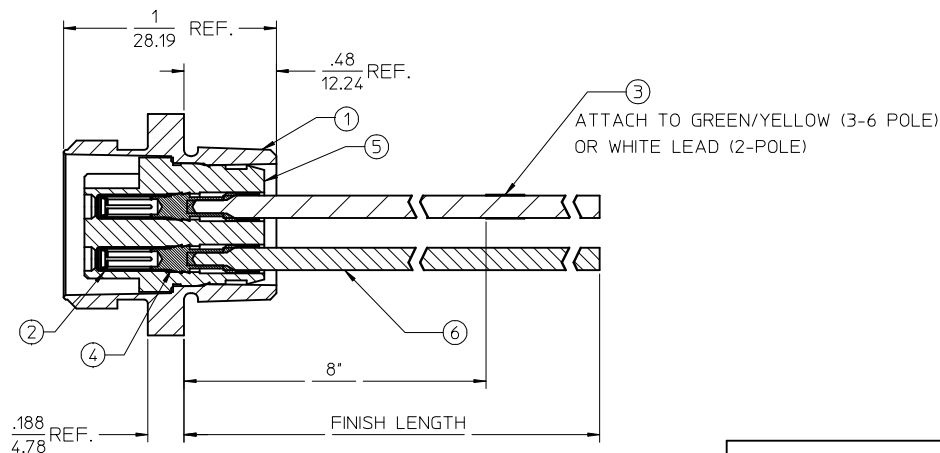

FINAL ASSEMBLY
1300130060 (SHOWN)

ENTER DESCRIPTION EC NO: MNA2010-0057 DRAWN BY: NKUMAR01 2009/07/13 CHKD: JFMURPHY APPR: JFMURPHY 2009/08/10 REV: A	DESCRIPTION DESCRIPTION	QUALITY SYMBOLS ▽=0 ▽=0	GENERAL TOLERANCES (UNLESS SPECIFIED)		DIMENSION STYLE SECTYON Z-Z	SCALE 2:1	DESIGN UNITS INCH	THIRD ANGLE PROJECTION
			mm INCH	DRAWN BY NKUMAR01	DATE 31/07/09	TITLE MC 2P FR 12IN 16/1 PVC		
			4 PLACES ± --- ± --- 3 PLACES ± --- ± --- 2 PLACES ± --- ± --- 1 PLACE ± --- ± ---	CHECKED BY BWOODMAN	DATE 31/07/09	APPROVED BY JFMURPHY		
			ANGULAR ±1/2°		DATE 31/07/09			
DRAFT WHERE APPLICABLE MUST REMAIN WITHIN DIMENSIONS			DOCUMENT NO. SD-130013-060			SHEET NO. 1 OF 2		
THIS DRAWING CONTAINS INFORMATION THAT IS PROPRIETARY TO MOLEX INCORPORATED AND SHOULD NOT BE USED WITHOUT WRITTEN PERMISSION								

FEMALE RECEPTACLE ASSEMBLY

2 POLE	3 POLE	4 POLE	5 POLE	6 POLE
--------	--------	--------	--------	--------

Sl. No.	DESCRIPTION	MATERIAL	FINISH	QUANTITY				
1	RECEPTACLE SHELL	ZINC DIECAST	BLACK E-COAT	1	1	1	1	1
2	SOCKET SLEEVE - TUBE	STAINLESS STEEL	PASSIVATED	2	3	4	5	6
3	LABEL	PLASTIC FILM	BLACK/YELLOW	1	1	1	1	1
4	SOCKET CONTACT 16AWG	COPPER ALLOY	GOLD PLATED	2	3	4	5	6
5	2P FEM INSERT PVC A-SIZE	PVC	YELLOW	1				
	3P FEM INSERT PVC A-SIZE	PVC	YELLOW		1			
	4P FEM INSERT PVC A-SIZE	PVC	YELLOW			1		
	5P FEM INSERT PVC A-SIZE	PVC	YELLOW				1	
6	#16-1 BLK PVC WIRE UL1015	PVC JACKET	BLACK	1	1	1	1	1
	#16-1 BLU PVC WIRE UL1015	PVC JACKET	BLUE					1
	#16-1 GRN/YEL PVC WIRE UL1015	PVC JACKET	GREEN/YELLOW		1	1	1	1
	#16-1 ORN PVC WIRE UL1015	PVC JACKET	ORANGE				1	1
	#16-1 RED PVC WIRE UL1015	PVC JACKET	RED			1	1	1
	#16-1 WHT PVC WIRE UL1015	PVC JACKET	WHITE		1	1	1	1

POLE COUNT	MAX. VOLTAGE RATING	MAX. CURRENT RATING
2 POLE	600 VOLTS	13 AMPS
3 POLE	600 VOLTS	13 AMPS
4 POLE	600 VOLTS	10 AMPS
5 POLE	600 VOLTS	8 AMPS
6 POLE	600 VOLTS	8 AMPS

PART NUMBER	DESCRIPTION	FINISHED LENGTH
1300130060	1R2004A20A120	12.0" +.75" -0 [0.3M +19.1MM -0]
1300130067	1R2004A20F060	6.0' +2.19' -0 [1.8M +55.6MM -0]
1300130135	1R3004A20A120	12.0" +.75" -0 [0.3M +19.1MM -0]
1300130148	1R3004A20F060	6.0' +2.19' -0 [1.8M +55.6MM -0]
1300130314	1R4004A20A120	12.0" +.75" -0 [0.3M +19.1MM -0]
1300130325	1R4004A20F060	6.0' +2.19' -0 [1.8M +55.6MM -0]
1300130442	1R5004A20A120	12.0" +.75" -0 [0.3M +19.1MM -0]
1300130452	1R5004A20F060	6.0' +2.19' -0 [1.8M +55.6MM -0]
1300130567	1R6004A20A120	12.0" +.75" -0 [0.3M +19.1MM -0]
1300130576	1R6004A20F060	6.0' +2.19' -0 [1.8M +55.6MM -0]

ENTER DESCRIPTION EC NO: MNA2010-0057 DRAWN BY: DRWINAKUMAR01 2009/07/31 CHKD: APPR: JFMURPHY 2009/08/10 REV: A	QUALITY SYMBOLS ▽=0 ▽=0	GENERAL TOLERANCES (UNLESS SPECIFIED) <table border="1" style="width: 100%; border-collapse: collapse;"> <tr> <th></th> <th>mm</th> <th>INCH</th> </tr> <tr> <td>4 PLACES</td> <td>± .005</td> <td>± .0002</td> </tr> <tr> <td>3 PLACES</td> <td>± .005</td> <td>± .0002</td> </tr> <tr> <td>2 PLACES</td> <td>± .005</td> <td>± .0002</td> </tr> <tr> <td>1 PLACE</td> <td>± .005</td> <td>± .0002</td> </tr> </table> ANGULAR ±1/2° DRAFT WHERE APPLICABLE MUST REMAIN WITHIN DIMENSIONS		mm	INCH	4 PLACES	± .005	± .0002	3 PLACES	± .005	± .0002	2 PLACES	± .005	± .0002	1 PLACE	± .005	± .0002	DIMENSION STYLE IN/MM DRAWN BY: NKUMAR01 DATE: 31/07/09 CHECKED BY: BWOODMAN DATE: 31/07/09 APPROVED BY: JFMURPHY DATE: 31/07/09	SCALE 2:1 TITLE MC 2P FR 12IN 16/1 PVC	DESIGN UNITS INCH THIRD ANGLE PROJECTION	MATERIAL NO. SEE CHART DOCUMENT NO. SD-130013-060 SHEET NO. 2 OF 2
	mm	INCH																			
4 PLACES	± .005	± .0002																			
3 PLACES	± .005	± .0002																			
2 PLACES	± .005	± .0002																			
1 PLACE	± .005	± .0002																			