

Project: _____ Type: _____

Drawn by: _____ Catalogue #: _____ Date: _____

Individual Spec Sheet

MOUNTING PLATE

WITH HANGER BARS

Downlight Accessory

ORDERING INFORMATION

Order code: 66817
Model number: ACC/MPLATE/VELOCE6/HANG.BARS/STD
UPC: 069549668171
Case quantity: 8

PHYSICAL DATA

Type: Mounting Plate with Hanger Bars
Material: Galvanized Iron
Length: 15 7/8" (403.6 mm)
Width: 12 3/16" (310 mm)
Height: 9 5/16" (236 mm)
Opening diameter: 6" (153 mm)

DIMENSIONS

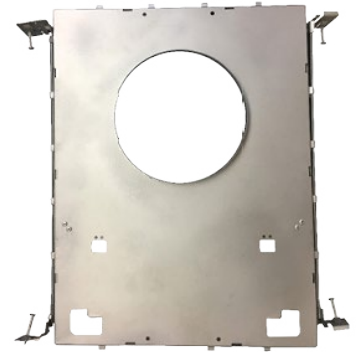
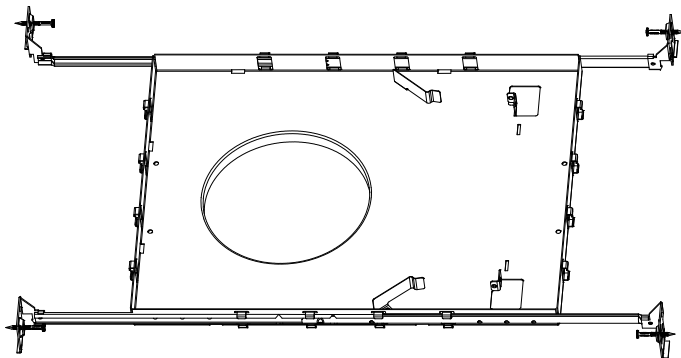

Qty	Description	Price

I accept the specifications of the luminaire configuration mentioned above.

Name: _____

Company: _____

Signature: _____

Date: _____

Data is based upon tests performed in a controlled environment. Actual performance can vary depending on operating conditions.
 All products are subject to change or may be discontinued any time without notice.