

THIS COPY IS PROVIDED ON A RESTRICTED BASIS AND IS NOT TO BE USED IN ANY WAY DETRIMENTAL TO THE INTERESTS OF PANDUIT CORP.

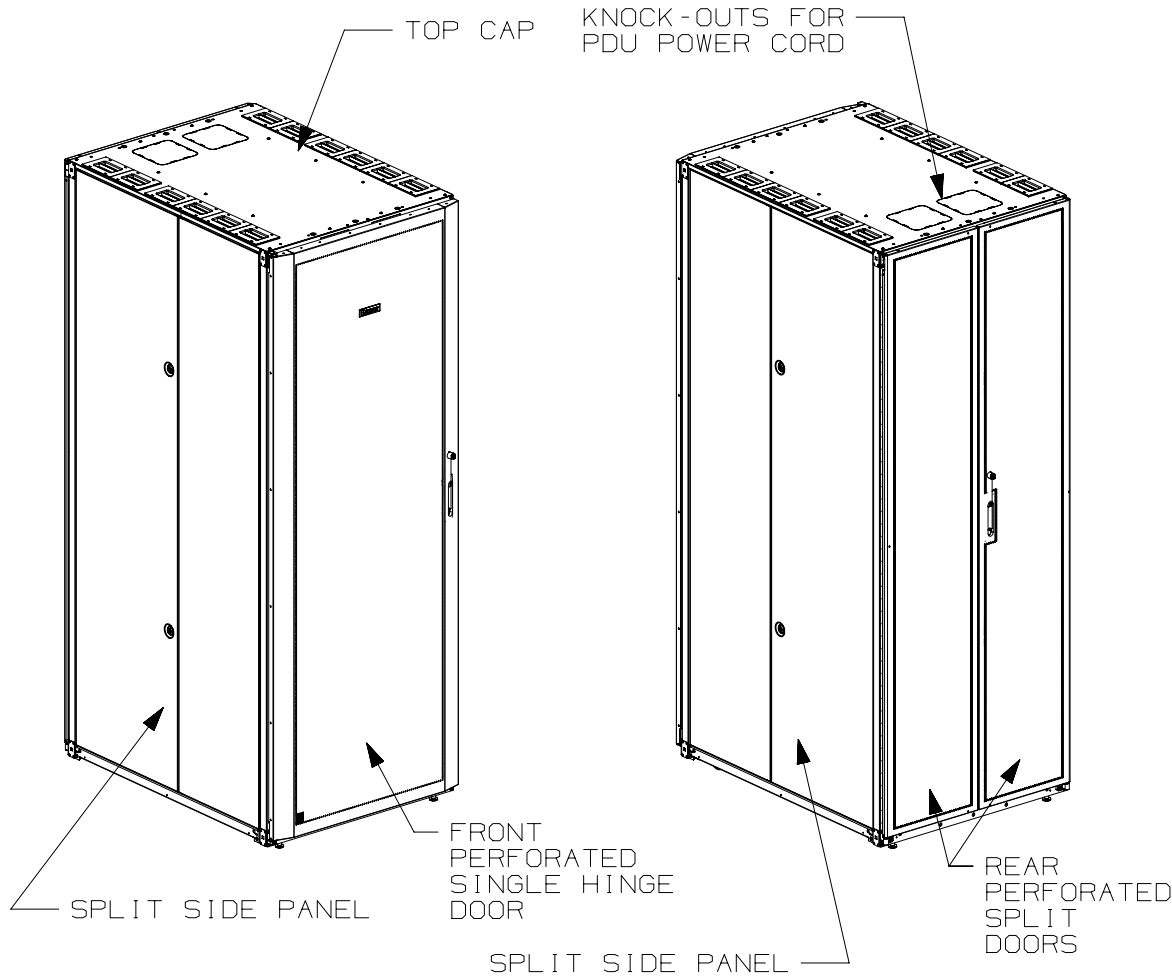

1. VISIT OUR ON-LINE CATALOG AT WWW.PANDUIT.COM FOR A LIST OF CURRENT PARTS APPLICABLE FOR USE WITH THIS PRODUCT.
2. PRIMARY DIMENSIONS ARE IN MILLIMETERS.
3. RAIL ADJUSTMENTS MEASUREMENTS ARE TAKEN FROM THE FRONT FACE OF EACH EQUIPMENT RAIL. INDEPENDENT ADJUSTABLE REAR EQUIPMENT MOUNTING RAILS (EIA) ADJUST FROM 141mm [5.5in] TO 437mm [17.2in] AND FROM 526mm [20.7in] TO 933mm [36.7in] WITH PDU BRACKETS AND CABLE MANAGEMENT FINGERS IN PLACE.
4. CAN BE USED WITH ANY 19" EIA STANDARD COMPONENT IN ADDITION TO ALL PANDUIT HORIZONTAL CABLE MANAGEMENT AND PATCH PANEL PRODUCTS.
5. EIA UNIVERSAL STANDARD HOLE PROGRESSION ON EQUIPMENT RAILS 15.88mm [.625in], 15.88mm [.625in], 12.70mm [.5in], 15.88mm [.625in], 15.88mm [.625in], 12.7mm [.5in]...ETC.
6. PARTS SUPPLIED:
 - BASE CABINET
 - FRONT PERFORATED SINGLE HINGE DOOR (SEE CHART ON SHEET 2)
 - REAR PERFORATED SPLIT DOOR (SEE CHART ON SHEET 2)
 - EQUIPMENT RAILS FRONT & REAR (SEE CHART ON SHEET 2)
 - PDU BRACKETS (SEE CHART ON SHEET 2)
 - CASTERS (SEE CHART ON SHEET 2)
 - INSTRUCTION SHEET
7. RACK UNIT SPACING NUMERALS ARE CLEARLY PRINTED ON EQUIPMENT MOUNTING RAILS.
8. FULLY BONDED STRUCTURE WHEN ASSEMBLED PER INSTRUCTIONS.
9. STATIC LOAD RATING. 1360 Kg (3000 LBS)
10. ROLLING LOAD RATING. 1133 Kg (2500 LBS)
11. SINGLE POINT GROUND LOCATIONS AT TOP AND BOTTOM OF CABINET.
12. ALL CABINET RAILS ARE INSTALLED NUMBERS UP.
13. MAXIMUM EQUIPMENT DEPTH, 959mm [37.75].

REV	DATE	BY	CHK	APR	DESCRIPTION	ECN
02A	08-26-20	RAMA	ELE	ELE	REMOVED ALL PART NUMBERS ENDING WITH "S"	V09000BX
01A	11-13-14	PBS	ADP	TCN	FLOOR MOUNT DIMENSIONS UPDATED	V09000BX
00B	5-13-13	MDCA	JDW	JDWE	REVISED CHART	12V305TL-DC
00A	8-29-12	TWV	JDW	PBD	RELEASED TO PRODUCTION	12V305TL-DC

TITLE					NET-ACCESS S TYPE CABINET 800mm WIDE X 1070mm DEEP FAMILY CUSTOMER DRAWING				
ITEM REVISION NAME					12V305TL/02.PRT				
DATASET FILE NAME					12V305TL_DC/02A.PRT				
MATERIAL:					N/A				
DRAWING NUMBER:					12V305TL-DC				
DRAWN BY		DATE		CHK		SCALE		SIZE	
TWV		8-29-12		JDW		NONE		SHT 1 OF 5 A	

THIS COPY IS PROVIDED ON A RESTRICTED BASIS AND IS NOT TO BE USED IN ANY WAY DETRIMENTAL TO THE INTERESTS OF PANDUIT CORP.

PART NO.	DESCRIPTION	SINGLE HINGE FRONT DOOR	SPLIT REAR DOOR	SPLIT SIDE PANEL	FRONT CAGE NUT E-RAIL	REAR CAGE NUT FINGER MGMT E-RAIL	REAR CAGE NUT VERTICAL PATCH E-RAIL	STANDARD PDU BRACKETS	CASTERS	CABLE MGMT FINGERS	VERTICAL PATCHING	CABINET WEIGHT FULLY UNPACKAGED	CABINET WEIGHT SHIPPING WEIGHT
S8212*	NET-ACCESS S-TYPE CABINET 800mm X 42RU X 1070mm DEEP	01	01	02	02	02	00	02	04	00	00	142 Kg/EACH 315 LBS/EACH	163 Kg/EACH 360 LBS/EACH
S8512*	NET-ACCESS S-TYPE CABINET 800mm X 45RU X 1070mm DEEP	01	01	02	02	02	00	02	04	00	00	149 Kg/EACH 330 LBS/EACH	170 Kg/EACH 375 LBS/EACH
S8812*	NET-ACCESS S-TYPE CABINET 800mm X 48RU X 1070mm DEEP	01	01	02	02	02	00	02	04	00	00	156 Kg/EACH 345 LBS/EACH	176 Kg/EACH 390 LBS/EACH
S8219*	NET-ACCESS S-TYPE CABINET 800mm X 42RU X 1070mm DEEP	01	01	00	02	02	00	02	04	00	00	120 Kg/EACH 265 LBS/EACH	140 Kg/EACH 310 LBS/EACH
S8519*	NET-ACCESS S-TYPE CABINET 800mm X 45RU X 1070mm DEEP	01	01	00	02	02	00	02	04	00	00	127 Kg/EACH 280 LBS/EACH	147 Kg/EACH 325 LBS/EACH
S8819*	NET-ACCESS S-TYPE CABINET 800mm X 48RU X 1070mm DEEP	01	01	00	02	02	00	02	04	00	00	133 Kg/EACH 295 LBS/EACH	154 Kg/EACH 340 LBS/EACH
S8212*F	NET-ACCESS S-TYPE CABINET 800mm X 42RU X 1070mm DEEP	01	01	02	02	02	00	02	04	01	00	143 Kg/EACH 317 LBS/EACH	164 Kg/EACH 362 LBS/EACH
S8512*F	NET-ACCESS S-TYPE CABINET 800mm X 45RU X 1070mm DEEP	01	01	02	02	02	00	02	04	01	00	150 Kg/EACH 332 LBS/EACH	171 Kg/EACH 377 LBS/EACH
S8812*F	NET-ACCESS S-TYPE CABINET 800mm X 48RU X 1070mm DEEP	01	01	02	02	02	00	02	04	01	00	157 Kg/EACH 347 LBS/EACH	177 Kg/EACH 392 LBS/EACH
S8219*F	NET-ACCESS S-TYPE CABINET 800mm X 42RU X 1070mm DEEP	01	01	00	02	02	00	02	04	01	00	121 Kg/EACH 267 LBS/EACH	141 Kg/EACH 312 LBS/EACH
S8519*F	NET-ACCESS S-TYPE CABINET 800mm X 45RU X 1070mm DEEP	01	01	00	02	02	00	02	04	01	00	128 Kg/EACH 282 LBS/EACH	148 Kg/EACH 327 LBS/EACH
S8819*F	NET-ACCESS S-TYPE CABINET 800mm X 48RU X 1070mm DEEP	01	01	00	02	02	00	02	04	01	00	134 Kg/EACH 297 LBS/EACH	155 Kg/EACH 342 LBS/EACH

* DENOTES COLOR
 "B" = BLACK, "W" = WHITE

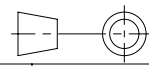
							TITLE NET-ACCESS S TYPE CABINET 800mm WIDE X 1070mm DEEP FAMILY CUSTOMER DRAWING							
							ITEM REVISION NAME 12V305TL/02.PRT							
							DATASET FILE NAME 12V305TL_DC/02A.PRT							
02A	8-26-20	RAMA	ELE	ELE	SEE SHEET 1 OF 5 FOR REVISIONS		V09000BX	 THIRD ANGLE PROJECTION				MATERIAL: N/A		
01A	11-13-14	PBS	ADP	TCN	SEE SHEET 1 OF 5 FOR REVISIONS		V09000BX							
00B	5-13-13	MDCA	JDW	JDWE	SEE SHEET 1 OF 5 FOR REVISIONS		12V305TL-DC							
00A	8-29-12	TWV	JDW	PBD	SEE SHEET 1 OF 5 FOR REVISIONS		12V305TL-DC							
REV	DATE	BY	CHK	APR	DESCRIPTION		ECN	DRAWN BY	DATE	CHK	SCALE	DRAWING NUMBER:		
								TWV	8-29-12	JDW	NONE	SHT 2 OF 5		
													SIZE	A

THIS COPY IS PROVIDED ON A RESTRICTED BASIS AND IS NOT TO BE USED IN ANY WAY DETRIMENTAL TO THE INTERESTS OF PANDUIT CORP.

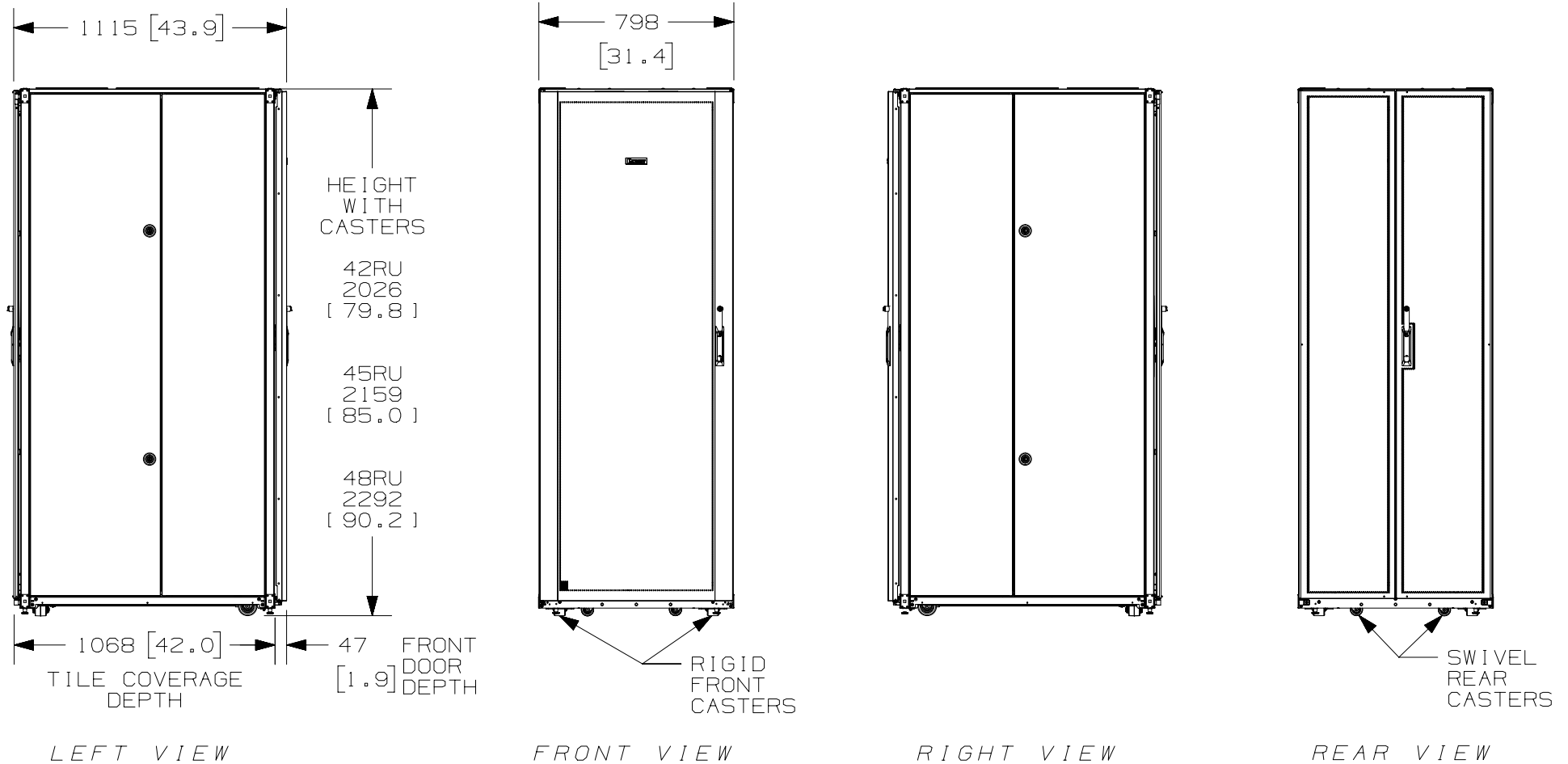

REV	DATE	BY	CHK	APR	DESCRIPTION	ECN
02A	8-26-20	RAMA	ELE	ELE	SEE SHEET 1 OF 5 FOR REVISIONS	V09000BX
01A	11-13-14	PBS	ADP	TCN	SEE SHEET 1 OF 5 FOR REVISIONS	V09000BX
00B	5-13-13	MDCA	JDW	JDWE	SEE SHEET 1 OF 5 FOR REVISIONS	12V305TL-DC
00A	8-29-12	TWV	JDW	PBD	SEE SHEET 1 OF 5 FOR REVISIONS	12V305TL-DC

TITLE		NET-ACCESS S TYPE CABINET 800mm WIDE X 1070mm DEEP FAMILY CUSTOMER DRAWING	
ITEM REVISION NAME		12V305TL/02.PRT	
DATASET FILE NAME		12V305TL_DC/02A.PRT	
DRAWING NUMBER:		12V305TL-DC	
MATERIAL:		N/A	
THIRD ANGLE PROJECTION			
DRAWN BY	DATE	CHK	SCALE
TWV	8-29-12	JDW	NONE
SHT 3 OF 5		SIZE A	

THIS COPY IS PROVIDED ON A RESTRICTED BASIS AND IS NOT TO BE USED IN ANY WAY DETRIMENTAL TO THE INTERESTS OF PANDUIT CORP.

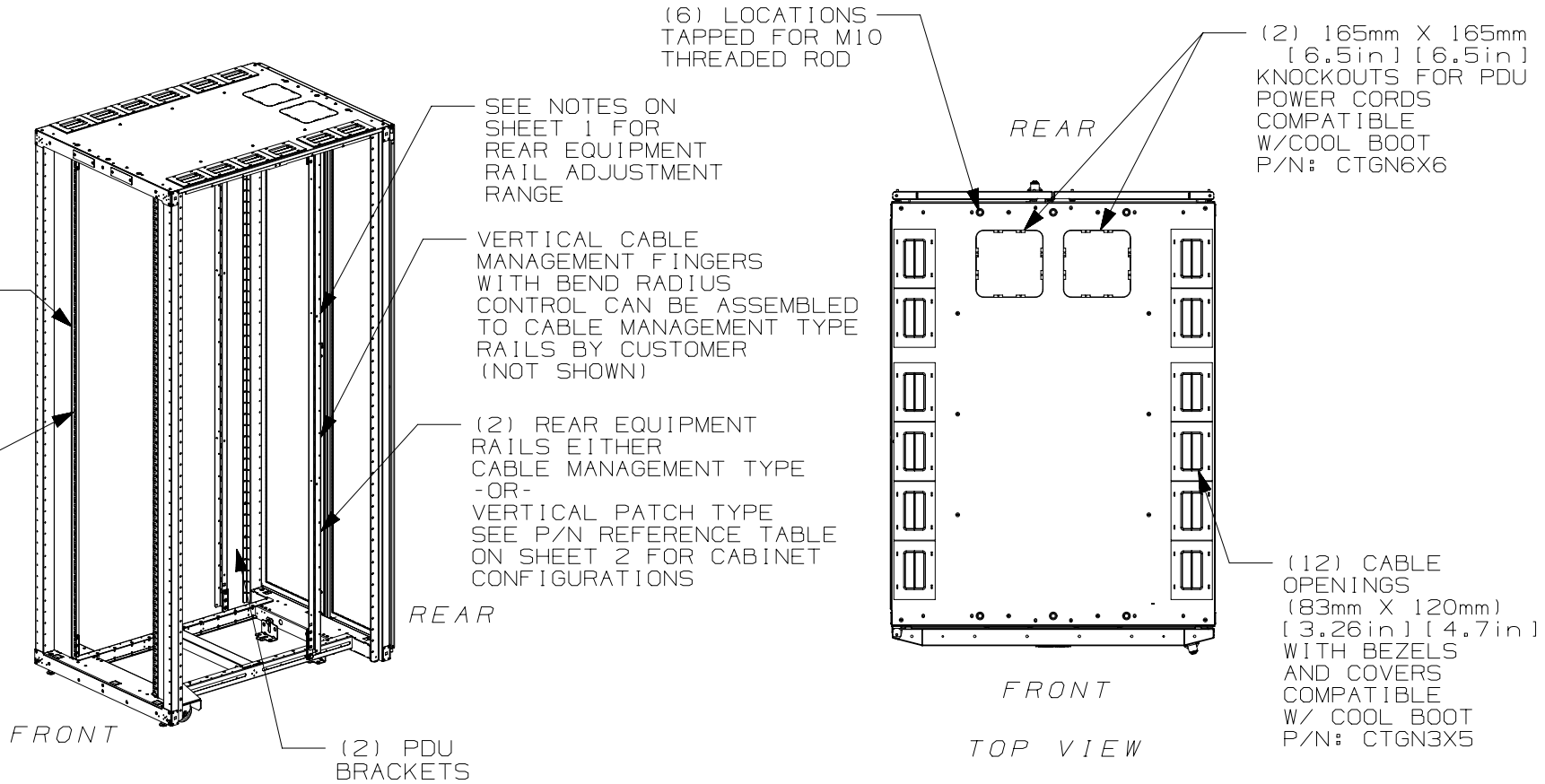

FRONT DOOR, REAR DOOR, AND SIDE PANELS NOT SHOWN

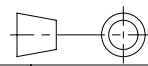
REV	DATE	BY	CHK	APR	DESCRIPTION	ECN	TITLE		DRAWING NUMBER:			
							NET-ACCESS S TYPE CABINET 800mm WIDE X 1070mm DEEP FAMILY		12V305TL-DC			
							CUSTOMER DRAWING		N/A			
							ITEM REVISION NAME 12V305TL/02.PRT					
							DATASET FILE NAME 12V305TL_DC/02A.PRT					
02A	8-26-20	RAMA	ELE	ELE	SEE SHEET 1 OF 5 FOR REVISIONS	V09000BX	 THIRD ANGLE PROJECTION					
01A	11-13-14	PBS	ADP	TCN	SEE SHEET 1 OF 5 FOR REVISIONS	V09000BX						
00B	5-13-13	MDCA	JDW	JDWE	SEE SHEET 1 OF 5 FOR REVISIONS	12V305TL-DC						
00A	8-29-12	TWV	JDW	PBD	SEE SHEET 1 OF 5 FOR REVISIONS	12V305TL-DC						
							DRAWN BY	DATE	CHK	SCALE		SIZE
							TWV	8-29-12	JDW	NONE	SHT 4 OF 5	A

THIS COPY IS PROVIDED ON A RESTRICTED BASIS AND IS NOT TO BE USED IN ANY WAY DETRIMENTAL TO THE INTERESTS OF PANDUIT CORP.

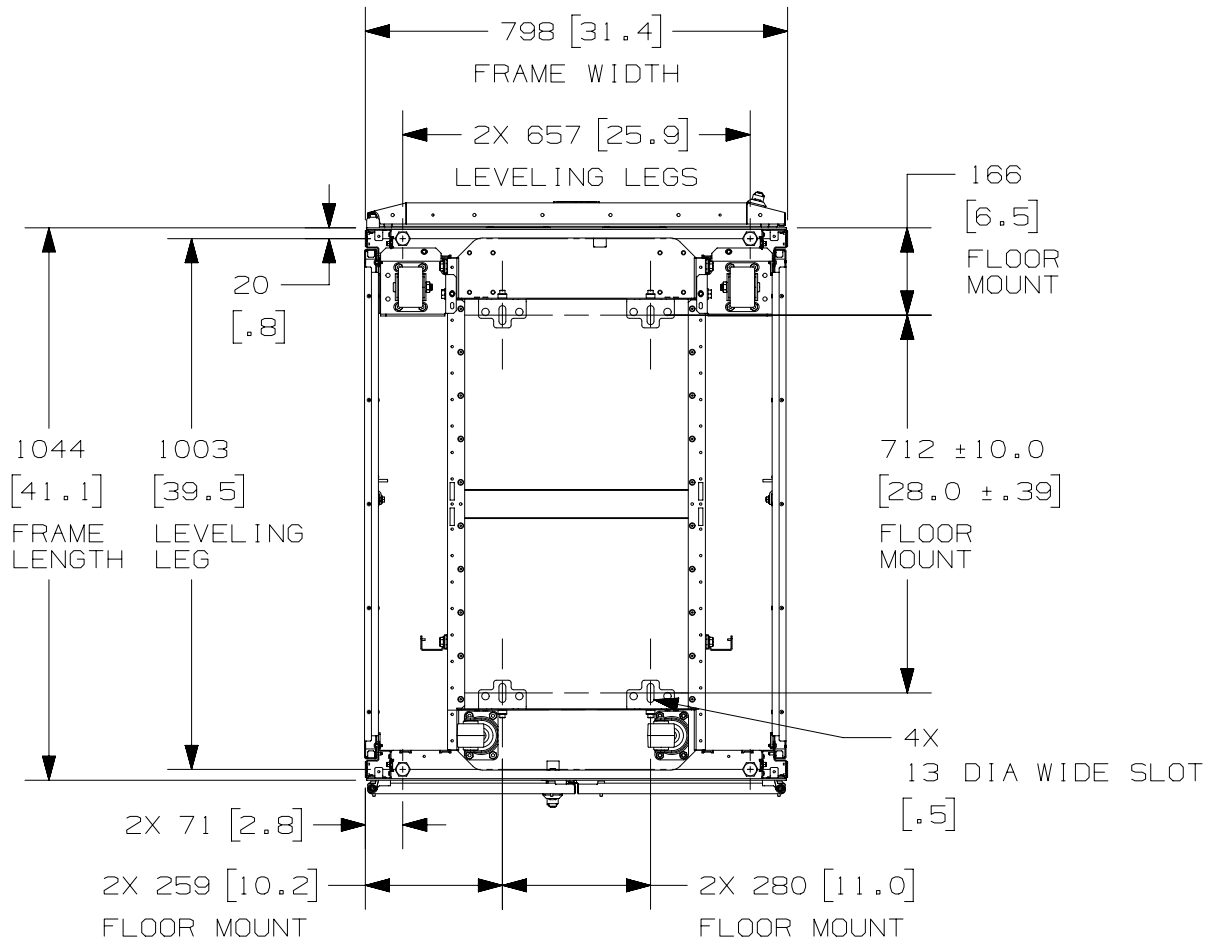

REAR OF CABINET
BOTTOM VIEW

FLOOR MOUNTING HOLE LOCATIONS -
SOME PARTS REMOVED FOR CLARITY

REV	DATE	BY	CHK	APR	DESCRIPTION	ECN
02A	8-26-20	RAMA	ELE	ELE	SEE SHEET 1 OF 5 FOR REVISIONS	V09000BX
01A	11-13-14	PBS	ADP	TCN	SEE SHEET 1 OF 5 FOR REVISIONS	V09000BX
00B	5-13-13	MDCA	JDW	JDWE	SEE SHEET 1 OF 5 FOR REVISIONS	12V305TL-DC
00A	8-29-12	TWV	JDW	PBD	SEE SHEET 1 OF 5 FOR REVISIONS	12V305TL-DC

TITLE		NET-ACCESS S TYPE CABINET 800mm WIDE X 1070mm DEEP FAMILY	
		CUSTOMER DRAWING	
ITEM REVISION NAME		12V305TL/02.PRT	
DATASET FILE NAME		12V305TL_DC/02A.PRT	
		PANDUIT	
		MATERIAL: N/A	
		DRAWING NUMBER: 12V305TL-DC	
DRAWN BY	DATE	CHK	SCALE
TWV	8-29-12	JDW	NONE
		THIRD ANGLE PROJECTION	
		SHT 5 OF 5	
		SIZE A	