

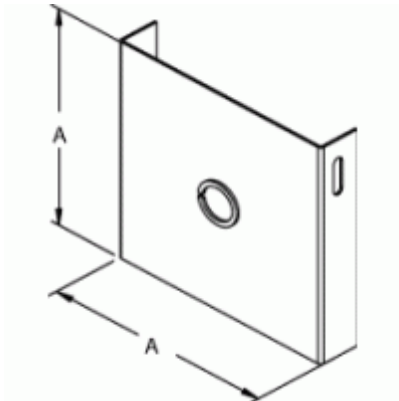

Quality Products. Service Excellence.

Closing Plate *CWCP Series*



- Comes complete with 1.75" KO

Painted Steel

Part No.	For use with	H	W
CWCP2	2.5 x 5.5	2.40	2.40
CWCP4	4 x 4	3.90	3.90
CWCP6	6 x 6	5.90	5.90
CWCP8	8 x 8	7.90	7.90
CWCP10	10 x 10	9.90	9.90
CWCP12	12 x 12	11.90	11.90

Unpainted Galvanized

Part No.	For use with	H	W
CWCP2G	2.5 x 5.5	2.40	2.40
CWCP4G	4 x 4	3.90	3.90
CWCP6G	6 x 6	5.90	5.90
CWCP8G	8 x 8	7.90	7.90
CWCP10G	10 x 10	9.90	9.90
CWCP12G	12 x 12	11.90	11.90



Data subject to change without notice

© 2021. Hammond Manufacturing Ltd. All rights reserved.