

# SIEMENS

Circuit breaker with thermal-magnetic trip unit  
 Leistungsschalter mit thermomagnetischen Auslösern  
 Disjoncteurs avec déclenchement thermomagnétique  
 Interruptores automáticos, con disparadores termomagnéticos  
 Interruttori automatici con sganciatori termomagnetici  
 Disjuntor com disparadores termomagnéticos  
 Termomanyetik tetikleyicilere sahip güç şalteri  
 Автоматический выключатель с термомангнитными расцепителями  
 Wyłącznik mocy z wyzwalaczami termomagnetycznymi  
 采用热磁跳闸单元的断路器







3VA52.. - .EC.1	3VA52.. - .MH31	UL489
3VA52.. - .ED.1	3VA52.. - .MU31	

<i>Operating Instructions</i>	<i>Betriebsanleitung</i>	<i>Notice d'utilisation</i>	<i>Instructivo</i>	<i>Istruzioni operative</i>
<i>Instruções de Serviço</i>	<i>İşletme kılavuzu</i>	<i>Руководство по эксплуатации</i>	<i>Instrukcja obsługi</i>	<i>使用说明</i>

		<b>EN</b> <b>DANGER</b> <b>Hazardous voltage. Will cause death or serious injury.</b> Turn off and lock out all power supplying this device before working on this device. Replace all covers before power supplying this device is turned on.
		<b>NOTICE</b> Installation and maintenance must be carried out by qualified personnel.
<b>DE</b> <b>GEFAHR</b> <b>Gefährliche Spannung. Lebensgefahr oder schwere Verletzungsgefahr.</b> Bevor Arbeiten am Gerät durchgeführt werden, müssen alle Stromquellen ausgeschaltet und mit einer Einschaltssicherung versehen werden. Vor dem Wiedereinschalten der Stromquellen müssen alle Abdeckungen wieder angebracht werden.	<b>FR</b> <b>DANGER</b> <b>Tension électrique dangereuse. Danger de mort ou risque de blessures graves.</b> Avant d'intervenir sur l'appareil, couper toutes les sources de tension et les consigner contre la refermeture. Remettre en place tous les couvercles avant de remettre l'appareil sous tension.	
<b>HINWEIS</b> Installations- und Wartungsarbeiten sind von qualifiziertem Personal durchzuführen.	<b>NOTIFICATION</b> L'installation et la maintenance doivent être effectuées uniquement par des personnes qualifiées.	
<b>ES</b> <b>PELIGRO</b> <b>Tensión peligrosa. Puede causar la muerte o lesiones graves.</b> Antes de trabajar en este dispositivo, desconecte y bloquee todas las fuentes que lo alimentan eléctricamente. Recoloque todas las cubiertas antes de volver a conectar la alimentación eléctrica para este dispositivo.	<b>IT</b> <b>PERICOLO</b> <b>Tensione pericolosa. Può causare la morte o lesioni gravi.</b> Prima di lavorare su questa apparecchiatura, disinserire tutte le fonti di alimentazione elettrica dell'apparecchiatura ed assicurarle contro la reinserzione. Riapplicare tutte le coperture prima di reinserire l'alimentazione di questa apparecchiatura.	
<b>NOTA</b> La instalación y el mantenimiento deben correr a cargo de personal cualificado.	<b>NOTA</b> L'installazione e la manutenzione devono essere eseguite da personale qualificato.	
<b>PT</b> <b>PERIGO</b> <b>Tensão perigosa. Perigo de morte ou ferimentos graves.</b> Desligue e bloqueie todas as fontes de alimentação antes de executar quaisquer trabalhos no aparelho. Volte a colocar todas as coberturas antes de voltar a ligar as fontes de alimentação.	<b>TR</b> <b>TEHLİKE</b> <b>Tehlikeli gerilim. Ölüm tehlikesi veya ağır yaralanma tehlikesi mevcuttur.</b> Cihazda çalışmalar yapılmadan önce, tüm güç kaynakları kapatılmalı ve bir açma emniyetiyle donatılmalıdır. Güç kaynakları tekrar açılmadan önce tüm kapaklar yerlerine takılmalıdır.	
<b>ATENÇÃO</b> A instalação e manutenção têm de ser efetuadas por pessoal qualificado.	<b>NOT</b> Montaj ve bakım işlemleri kalifiye personel tarafından yapılmalıdır.	
<b>РУ</b> <b>ОПАСНО</b> <b>Опасное напряжение. Опасность для жизни или телесных повреждений.</b> До начала работы выключите и заблокируйте все источники питания этого устройства. Перед включением питания снова установите все крышки.	<b>PL</b> <b>ZAGROŻENIE</b> <b>Niebezpieczne napięcie. Niebezpieczeństwo poważnych obrażeń lub utraty życia.</b> Wyłączyć i zablokować wszystkie źródła zasilania urządzenia przed rozpoczęciem pracy na urządzeniu. Założyć wszystkie osłony przed podłączeniem urządzenia do źródła zasilania.	
<b>ПРИМЕЧАНИЕ</b> Установка и техническое обслуживание должны производиться квалифицированным персоналом.	<b>UWAGA</b> Instalacja i konserwacja muszą być wykonywane przez wykwalifikowany personel.	

Technical Support: [Internet: http://www.siemens.com/lowvoltage/technical-support](http://www.siemens.com/lowvoltage/technical-support)

<p><b>中</b>  <b>危险</b></p> <p>危险电压。可能导致生命危险或重伤危险。操作此设备前必须确保切断其电源并采取防接通保护措施。在设备接通电源前，更换所有盖板。</p>	<p><b>HR</b>  <b>OPASNOST</b></p> <p>Opasni napon. Opasnost po život ili opasnost od teških ozljeda. Prije rada na uređaju potrebno je isključiti sve izvore struje i osigurati uređaj zaštitom od uključivanja. Prije ponovnog uključivanja izvora struje potrebno je opet postaviti sve poklopce.</p>
<p> <b>注意</b></p> <p>安装和维护必须由具备专业资质的人员进行。</p>	<p> <b>НАРОМЕНА</b></p> <p>Montažu i održavanje treba obavljati kvalificirano osoblje.</p>
<p><b>FI</b>  <b>VAARA</b></p> <p>Vaarallinen jännite. Vakava loukkaantumisvaara tai hengenvaara. Laitteen kaikki virransyöttö tulee katkaista ja sen kytkeytyminen päälle tulee estää lukolla ennen kuin laitteeseen kohdistetaan mitään toimenpiteitä. Kaikki kotelot tulee kiinnittää takaisin ennen kuin laitteen virransyöttö kytketään uudelleen päälle.</p>	<p><b>БГ</b>  <b>ОПАСНОСТ</b></p> <p>Опасно напряжение. Опасност за живота или опасност от тежки телесни повреди. Преди да извършвате дейности по устройството, изключете и обезопасете всички захранващи източници. Поставете всички капацити на мястото им, преди отново да включите захранването на устройството.</p>
<p> <b>HUOMAUTUS</b></p> <p>Asennus- ja huoltotyöt on annettava pätevän ammattilaisen suoritettaviksi.</p>	<p> <b>ПРЕДУПРЕЖДЕНИЕ</b></p> <p>Инсталирането и поддръжката трябва да се извършват от квалифициран персонал.</p>
<p><b>EE</b>  <b>OHT</b></p> <p>Ohtlik pinge. Oht elule või raskete vigastuste oht. Enne seadme hooldustööd lülitage kõik toiteallikad välja ja võtke meetmeid nende sisselülitamise takistamiseks. Enne toiteallikate uuesti sisselülitamist tuleb kõik katted tagasi paigaldada.</p>	<p><b>LV</b>  <b>BĪSTAMI</b></p> <p>Bīstams spriegums. Letālu seku vai smagu traumu risks. Pirms veicat darbu ar šo ierīci pilnībā izslēdziet un nobloķējiet tās strāvas padevi. Pirms ieslēdzat ierīces strāvas padevi uzliedziet atpakaļ visus pārsegus.</p>
<p> <b>MÄRKUS</b></p> <p>Paigaldus- ja hooldustööd tohib teha ainult kvalifitseeritud personal.</p>	<p> <b>BRĪDINĀJUMS</b></p> <p>Uzstādīšana un tehniskā apkope jāveic kvalificētiem darbiniekiem.</p>
<p><b>LT</b>  <b>PAVOJUS</b></p> <p>Pavojinga įtampa. Pavojus gyvybei arba sunkausi susižalojimo pavojus. Prieš dirbdami ties šiuo prietaisu, išjunkite ir užblokuokite visus šio prietaiso maitinimo šaltinius. Prieš jungdami šio prietaiso maitinimo šaltinį, vėl uždėkite visus dangčius.</p>	<p><b>DA</b>  <b>FARE</b></p> <p>Farlig spænding. Livsfare eller risiko for slemme kvæstelser. Sluk for og lås strømmen, der forsyner denne enhed, før du arbejder med denne enhed. Erstat alle afdækninger, før strømmen, der tilføres denne enhed, tændes.</p>
<p> <b>NUORODA</b></p> <p>Jrengimą ir techninę priežiūrą turi vykdyti kvalifikuoti darbuotojai.</p>	<p> <b>BEMÆRK</b></p> <p>Installationen og vedligeholdelsen skal foretages af uddannet personale.</p>
<p><b>MT</b>  <b>PERIKLU</b></p> <p>Vultaġġ perikoluż. Riskju ta' mewt jew korriment serju. Qabel taħdem fuq dan l-apparat, itfi kull provvista tal-elettriku tiegħu u sakkar kontra xegħil mill-gdid aċċidentali. Erġa' installa l-ghotjien kollha qabel tirritorna l-provvista tal-elettriku fl-apparat.</p>	<p><b>NL</b>  <b>GEVAAR</b></p> <p>Gevaarlijke spanning. Levensgevaar of gevaar voor ernstig letsel. Voordat u aan dit apparaat werkt, moet u alle actieve energiebronnen voor dit apparaat uitschakelen. Plaats alle afdekkingen terug voordat u energiebronnen voor dit apparaat inschakelt.</p>
<p> <b>AVVIŻ</b></p> <p>L-installazzjoni u l-manutenzjoni għandhom jittwettqu minn personal ikkwalifikat.</p>	<p> <b>OPMERKING</b></p> <p>Installatie en onderhoud moeten worden verricht door gekwalificeerd personeel.</p>
<p><b>EL</b>  <b>ΚΙΝΔΥΝΟΣ</b></p> <p>Επικίνδυνη τάση. Κίνδυνος για τη ζωή ή σοβαρού τραυματισμού. Απενεργοποιήστε και ασφαλίστε όλη την ενέργεια που τροφοδοτεί τη συσκευή, προτού εργαστείτε σε αυτή. Τοποθετήστε ξανά όλα τα καλύμματα, προτού ενεργοποιήσετε την τροφοδοσία της συσκευής με ενέργεια.</p>	<p><b>GA</b>  <b>CONTÚIRT</b></p> <p>Voltaas contúirteach. Baol go bhfaighfear bás nó tromghortú. Mích gach cumhacht a sholáthraíonn an gléas seo agus glasáil amach í roimh obair a dhéanamh ar an ngléas seo. Cuir na clúdaigh ar fad ar ais roimh an gcumhacht a sholáthraíonn an gléas seo a chur ar siúl arís.</p>
<p> <b>ΠΡΟΣΟΧΉ</b></p> <p>Η εγκατάσταση και συντήρηση πρέπει να διεξάγονται από εξειδικευμένο προσωπικό.</p>	<p> <b>FÓGRA</b></p> <p>Ní mór don fheistiú agus don chothabháil a bheith déanta ag pearsanra cáilithe.</p>
<p><b>RO</b>  <b>PERICOL</b></p> <p>Tensiune periculoasă. Pericol de moarte sau de accidentări grave. Opriți și blocați alimentarea cu energie a acestui dispozitiv înainte de a lucra la acesta. Așezați la loc toate capacele înainte de a porni alimentarea cu energie a acestui dispozitiv.</p>	<p><b>SV</b>  <b>FARA</b></p> <p>Farlig spänning. Livsfara eller risk för allvarliga personskador. Innan arbete utförst på utrustningen ska strömförsörjningen till utrustningen stängas av. Montera alla skyddsplåtar igen innan utrustningen slås på.</p>
<p> <b>ÎNȘTIINȚARE</b></p> <p>Instalarea și întreținerea trebuie să se efectueze de către personalul calificat.</p>	<p> <b>OBS</b></p> <p>Installation och underhåll får endast utföras av kvalificerad personal.</p>
<p><b>CZ</b>  <b>NEBEZPEČÍ</b></p> <p>Nebezpečné napětí. Nebezpečí smrtelného nebo těžkého úrazu. Před zahájením prací na tomto zařízení odpojte a zajistěte veškeré přírůdy energie. Před opětovným připojením zařízení vraťte všechny kryty na svá místa.</p>	<p><b>SL</b>  <b>NEVARNOST</b></p> <p>Nevarna napetost. Nevarnost za življenje ali nevarnost hudih poškodb. Izklopite in prekinite celotno napajanje naprave, preden na njej opravljate dela. Preden napajanje znova vklopite, namestite vse pokrove.</p>
<p> <b>POZNÁMKA</b></p> <p>Instalaci a údržbu musí provádět kvalifikovaní pracovníci.</p>	<p> <b>OPOMBA</b></p> <p>Namestitev in vzdrževanje mora opraviti usposobljeno osebje.</p>
<p><b>SK</b>  <b>NEBEZPEČENSTVO</b></p> <p>Nebezpečné napätie. Nebezpečenstvo ohrozenia života alebo vzniku ťažkých zranení. Pred prácou na zariadení vypnite a zaistite všetky napájacie prípojky tohto zariadenia. Pred zapnutím napájania tohto zariadenia najprv nasadte späť všetky kryty.</p>	<p><b>HU</b>  <b>VESZÉLY</b></p> <p>Veszélyes feszültség. Életveszély vagy súlyos sérülésveszély. Mielőtt bármilyen munkavégzést kezd az eszközön, az áramellátást le kell kapcsolni, és véletlen bekapcsolás elleni védelemmel kell ellátni. Az áramellátás visszakapcsolása előtt minden burkolatot vissza kell helyezni.</p>
<p> <b>UPOZORNENIE</b></p> <p>Inštaláciu a údržbu musí vykonávať kvalifikovaný personál.</p>	<p> <b>MEGJEGYZÉS</b></p> <p>A telepítést és a karbantartást kizárólag szakképzett személyzet végezheti.</p>

	<b>EN</b>  <b>DANGER</b> <b>Hazardous voltage. Will cause death or serious injury.</b> Turn off and lock out all power supplying this device before working on this device. Replace all covers before power supplying this device is turned on.
<b>ES</b>  <b>PELIGRO</b> <b>Tensión peligrosa. Puede causar la muerte o lesiones graves.</b> Antes de trabajar en este dispositivo, desconecte y bloquee todas las fuentes que lo alimentan eléctricamente. Recoloque todas las cubiertas antes de volver a conectar la alimentación eléctrica para este dispositivo.	<b>FR</b>  <b>DANGER</b> <b>Tension électrique dangereuse. Danger de mort ou risque de blessures graves.</b> Avant d'intervenir sur l'appareil, couper toutes les sources de tension et les consigner contre la refermeture. Remettez en place tous les couvercles avant de remettre l'appareil sous tension.

 **Required tools / Notwendige Werkzeuge / Outils nécessaires / Herramientas requeridas / 必要工具** 



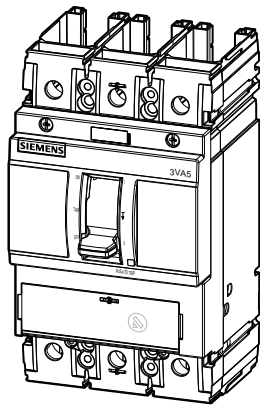

cal. ISO 6789

 **Contents / Lieferumfang / Etendue de la livraison / Alcance de suministro / 供货范围** 

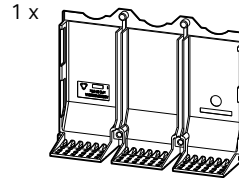
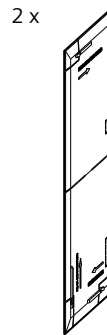
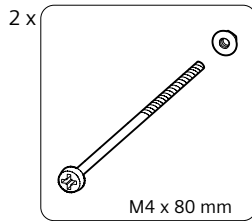

3VA5 250





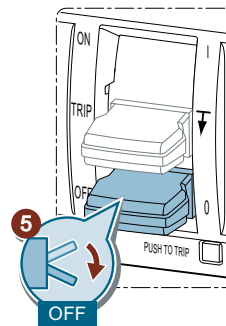
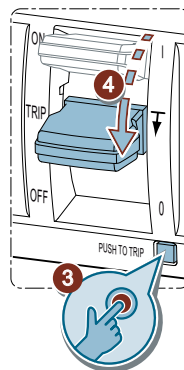
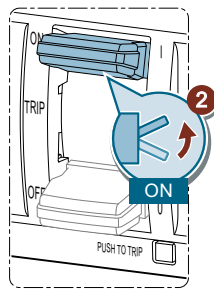
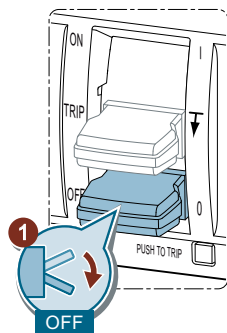

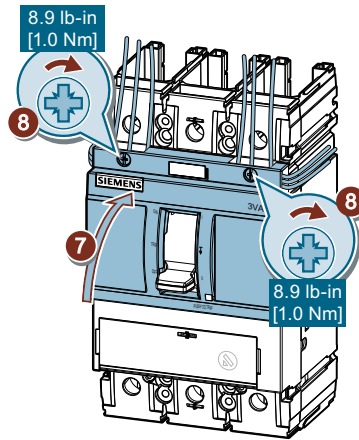
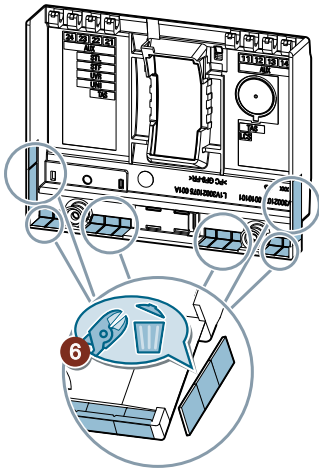
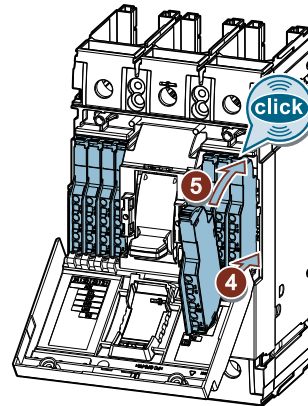
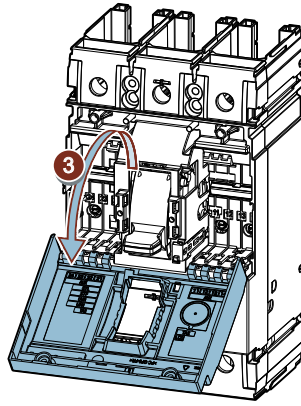
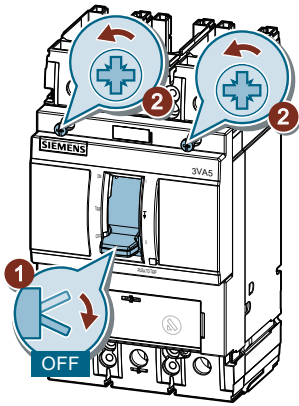
 **Test / Test / Test / Test / 测试** 







	<b>EN</b>  <b>DANGER</b> <b>Hazardous voltage. Will cause death or serious injury.</b> Turn off and lock out all power supplying this device before working on this device. Replace all covers before power supplying this device is turned on.
<b>ES</b>  <b>PELIGRO</b> <b>Tensión peligrosa. Puede causar la muerte o lesiones graves.</b> Antes de trabajar en este dispositivo, desconecte y bloquee todas las fuentes que lo alimentan eléctricamente. Recoloque todas las cubiertas antes de volver a conectar la alimentación eléctrica para este dispositivo.	<b>FR</b>  <b>DANGER</b> <b>Tension électrique dangereuse. Danger de mort ou risque de blessures graves.</b> Avant d'intervenir sur l'appareil, couper toutes les sources de tension et les consigner contre la refermeture. Remettez en place tous les couvercles avant de remettre l'appareil sous tension.



Settings / Parametrieren / Paramétrage / Parametrizar / 确定参数

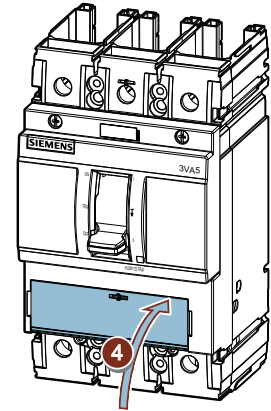
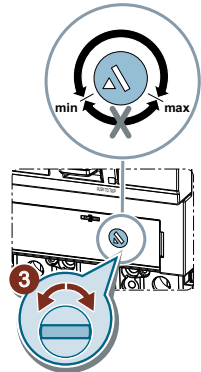
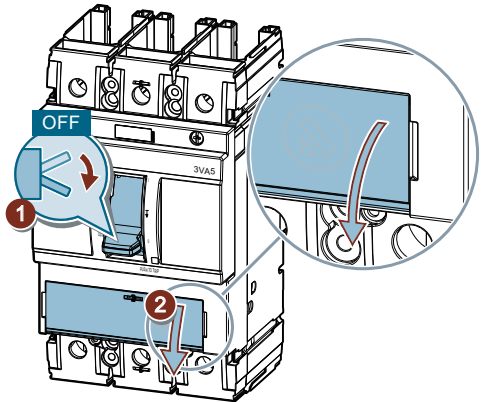

**TM230 FTAM**

$I_n$  / A

$I_r$       $I_r$   $I_{r\min}$   $I_{r\max}$

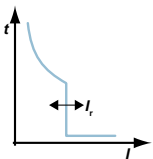
**TM120 M**

$I_n$  / A

$I_r$   $I_{r\min}$   $I_{r\max}$

**TM210 FTFM**

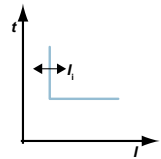
$I_r$       $I_r$   $10 \times I_n$  / A



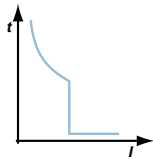



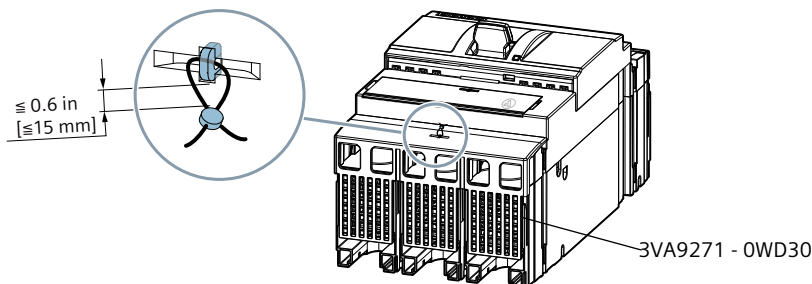









## Assembly / Montage / Montage / Montaje / 安装



## Information / Information / Informations / Información / 信息







	<p><b>EN</b> <b>DANGER</b>  <b>Arcing hazard. Will cause death or serious injury.</b>          One barrier method must be applied, as noted, per the specific application parameters.</p>
<p><b>DE</b> <b>GEFAHR</b>  <b>Lichtbogengefahr. Lebensgefahr oder schwere Verletzungsgefahr.</b>          Eine der aufgeführten Isolationsmaßnahmen muss, entsprechend den spezifischen Anwendungsparametern, vorgenommen werden.</p>	<p><b>FR</b> <b>DANGER</b>  <b>Danger d'arc. Danger des mort ou risque de blessures graves.</b>          Une méthode de barrière faut utilisées, comme indiqué, conformément à paramètres spécifiques de la utilisation</p>
<p><b>ES</b> <b>PELIGRO</b>  <b>Peligro de arco eléctrico Puede causar la muerte o lesiones graves.</b>          Es necesario aplicar, en base a los parámetros específicos de la aplicación, uno de los métodos de aislamiento indicados.</p>	<p><b>IT</b> <b>PERICOLO</b>  <b>Pericolo di formazione d'arco elettrico. Può provocare la morte o gravi lesioni.</b> Deve essere applicato un metodo di barriera, come già menzionato, che sia conforme ai parametri dell'applicazione.</p>
<p><b>PT</b> <b>PERIGO</b>  <b>Perigo de formação de arco voltaico. Perigo de morte ou ferimentos graves.</b> É necessário aplicar um método de barreira de separação, como referido, de acordo com os parâmetros de aplicação específicos.</p>	<p><b>TR</b> <b>TEHLİKE</b>  <b>Kıvılcım tehlikesi. Ölüm ya da ciddi yaralanmaya sebebiyet verir.</b>          Özel uygulama parametrelerinde belirtildiği şekilde tek bariyer yöntemin-den yararlanılmaldır.</p>
<p><b>РУ</b> <b>ОПАСНО</b>  <b>Опасность электрической дуги. Может привести к смерти или серьезным травмам.</b> Метод барьера должен быть применен, как уже отмечено, в соответствии с прикладными параметрами.</p>	<p><b>PL</b> <b>ZAGROŻENIE</b>  <b>Ryzyko wyładowań łukowych. Mogą powodować utratę życia lub poważne obrażenia.</b> Jak już wspomniano, należy zastosować jedną z metod ochronnych dla określonych parametrów użycia.</p>
<p><b>中</b> <b>危險</b>  <b>电弧危险。将导致死亡或重伤。</b>          必须如所述那样，根据特定应用参数应用一种屏障法。</p>	<p><b>HR</b> <b>OPASNOST</b>  <b>Opasnost od iskrenja. Opasnost po život ili opasnost od teških ozljeda.</b> Potrebno je koristiti metodu jedne prepreke, kao što je navedeno, po posebnim parametrima primjene.</p>
<p><b>FI</b> <b>VAARA</b>  <b>Valokaaren vaara. Seurauksena on vakava loukkaantuminen tai kuolema.</b> Yhden suojauskeinon käyttö on pakollista käyttökohteen erityisten parametrien mukaisesti, kuten on ilmoitettu.</p>	<p><b>БГ</b> <b>ОПАСНОСТ</b>  <b>Опасност от електрическа дъга. Може да причини смърт или сериозни наранявания.</b> Трябва да се използва метод с една преграда в съответствие с указанията и параметрите за конкретното приложение.</p>
<p><b>EE</b> <b>OHT</b>  <b>Keevituskaare oht. Võib olla eluohtlik või tekitada tõsiseid vigastusi.</b>          Rakendada tuleb ühte tõkkemeetodit vastavalt spetsiifilistele rakendusparameetritele.</p>	<p><b>LV</b> <b>BĪSTAMI</b>  <b>Lokizlādes risks. Izraisa nāvi vai smagus miesas bojājumus.</b>          Vienas barjeras metode saskaņā ar minēto jāizmanto katras konkrētās ierīces parametriem.</p>
<p><b>LT</b> <b>PAVOJUS</b>  <b>Lanko susidarymo pavojus. Sukels mirtį arba rimtą sužalojimą.</b>          Konkrečių naudojimo atvejų parametrus reikia taikyti, kaip nurodyta, vieno barjero metodą.</p>	<p><b>DA</b> <b>FARE</b>  <b>Lysbud fare. Forårsager død eller alvorlige kvæstelser.</b>          En afspærringsmetode skal bruges, som nævnt, efter de specifikke anvendelsesparametre.</p>
<p><b>MT</b> <b>PERIKLU</b>  <b>Periklu ta' arkjar (arcing). Dan jista' jikkawza mewt jew korrimenti gravi.</b> Kif gie nnotat, jista' jintuza metodu ta' protezzjoni wiehed biss skont il-parametri specifiċi tal-applikazzjoni.</p>	<p><b>NL</b> <b>GEVAAR</b>  <b>Gevaar van vonken. Leidt tot de dood of ernstig letsel.</b>          Er moet een blokkeringsmethode zijn toegepast (zoals opgemerkt) via de specifieke toepassingsparameters.</p>

















		<b>EN</b>  <b>DANGER</b> <b>Hazardous voltage. Will cause death or serious injury.</b> Turn off and lock out all power supplying this device before working on this device. Replace all covers before power supplying this device is turned on.
<b>ES</b>  <b>PELIGRO</b> <b>Tensión peligrosa. Puede causar la muerte o lesiones graves.</b> Antes de trabajar en este dispositivo, desconecte y bloquee todas las fuentes que lo alimentan eléctricamente. Recoloque todas las cubiertas antes de volver a conectar la alimentación eléctrica para este dispositivo.	<b>FR</b>  <b>DANGER</b> <b>Tension électrique dangereuse. Danger de mort ou risque de blessures graves.</b> Avant d'intervenir sur l'appareil, couper toutes les sources de tension et les consigner contre la refermeture. Remettre en place tous les couvercles avant de remettre l'appareil sous tension.	
<b>EL</b>  <b>ΚΙΝΔΥΝΟΣ</b> <b>Κίνδυνος σπινθηρισμών. Προκαλείται θάνατος ή σοβαρός τραυματισμός.</b> Πρέπει να εφαρμόζεται μία μέθοδος φραγμού, όπως επισημαίνεται, για τις συγκεκριμένες παραμέτρους εφαρμογής.	<b>GA</b>  <b>CONTÚIRT</b> <b>Baol stuála. Beidh sé ina chúis bháis nó tromghortaithe</b> Ní mór modh coiscthe amháin a fheidhmiú mar a cuireadh in iúl, de réir na bparaiméadar feidhme sainiúla.	
<b>RO</b>  <b>PERICOL</b> <b>Pericol de arc electric. Acesta va provoca decesul sau o vătămare gravă.</b> Trebuie să se aplice o metodă de barieră, conform indicațiilor, ținând cont de parametrii specifici ai aplicației.	<b>SV</b>  <b>FARA</b> <b>Överslagsrisk. Kommer att orsaka dödsfall eller allvarliga personskada.</b> Som nämnts måste en barriärmetod tillämpas enligt de specifika applikationsparametrarna.	
<b>SK</b>  <b>NEBEZPEČENSTVO</b> <b>Nebezpečnost vzniku el. oblúka. Nebezpečnost ohrozenia života alebo vzniku vážnych zranení.</b> Použitý musí byť jeden spôsob vytvorenia bariéry, ako to už bolo uvedené, podľa parametrov konkrétnej aplikácie.	<b>SL</b>  <b>NEVARNOST</b> <b>Nevarnost iskrenja. Nevarnost za življenje ali nevarnost hudih poškodb.</b> Uporabiti je treba eno metodo blokade, kot je navedeno, glede na parametre specifične aplikacije.	
<b>CZ</b>  <b>NEBEZPEČÍ</b> <b>Nebezpečí vzniku elektrického oblouku. Může způsobit usmrcení nebo vážné poranění</b> Je nezbytné použít uvedenou metodu jedné bariéry dle specifických parametrů dané aplikace.	<b>HU</b>  <b>VESZÉLY</b> <b>Ívksülés veszélye. Halált vagy komoly sérülést okoz.</b> Ahogy már említettük, az adott alkalmazási paramétereknek megfelelő szigetelési módot kell alkalmazni.	

Connection / Anschluss / Raccordement/ Conexión / Connessione / Conexão / Bağlantı / соединение / Połączenie / 连接			480 V AC 500 V DC	600 V AC 600 V DC	600 V AC 600 V DC	match barrier requirements / Isolationsanforderungen einhalten / Exigences de barrières respectées / Cumplir requisitos de aislamiento entre fases / coordinare i requisiti per barriera di separazione / corresponde aos requisitos da barreira / bariyer gereksinimlerini eşleştirmek / соответствуют требованиям к барьеру / dopasuj wymagania dot. barier / 匹配屏障要求			
			Line 1 3 5 Load 2 4 6	Line 1 3 5 Load 2 4 6	Line 1 3 5 Load 2 4 6				
		3VA923.-0JB12 3VA923.-0JG12 3VA923.-0JD12 3VA923.-0JK12	—	A B D	D I J	A		3VA9272-0WA00	
		3VA923.-0JA1.					B		3VA9272-0WA00
		3VA923.-0JJ13 3VA923.-0JC13 3VA923.-0JJ22 3VA923.-0JC22 3VA923.-0JF60		D				C	
		3VA923.-0QA00	—	A B D	D I J	D			3VA9271-0WF.0
		3VA927.-0QB00	D F		D		E		
		3VA923.-0QE.0	C G H		G H			F	
		3VA923.-0QA00	D F		D	G			3VA9272-0WA00 3VA9271-0WD.0
		3VA927.-0QB00	D F		D		H		
		3VA923.-0QF.0	C G H		G H			I	
		3VA923.-0QA00	—	A B D	D E F	J			3VA9272-0WA00 3VA9271-0WJ.0
		3VA927.-0QB00	D F		D		J		
		3VA923.-0QF.0	C G H		G H				

—: no barrier requirements / keine Isolationsanforderungen / Pas d'exigences de barrières / No hay requisitos de aislamiento entre fases / nessun requisito per barriera di separazione / não há requisitos de barreira / bariyer gereksinimleri yok / требования к барьеру отсутствуют / brak wymagań dot. barier / 无屏障要求

		EN	 <b>DANGER</b>
		Hazardous voltage. Will cause death or serious injury. Turn off and lock out all power supplying this device before working on this device. Replace all covers before power supplying this device is turned on.	
ES	 <b>PELIGRO</b>	FR	 <b>DANGER</b>
Tensión peligrosa. Puede causar la muerte o lesiones graves. Antes de trabajar en este dispositivo, desconecte y bloquee todas las fuentes que lo alimentan eléctricamente. Recoloque todas las cubiertas antes de volver a conectar la alimentación eléctrica para este dispositivo.		Tension électrique dangereuse. Danger de mort ou risque de blessures graves. Avant d'intervenir sur l'appareil, couper toutes les sources de tension et les consigner contre la refermeture. Remettez en place tous les couvercles avant de remettre l'appareil sous tension.	

	<b>Information / Information / Informations / Información / 信息</b>	
---	--	---

		EN	 <b>DANGER</b>
		Arcing hazard. Will cause death or serious injury. Ensure the adhesive insulator, as supplied from the factory, is in place for all applications not utilizing a trip interlock accessory. Do not apply breaker if insulator is missing.	
DE	 <b>GEFAHR</b>	FR	 <b>DANGER</b>
Lichtbogengefahr. Lebensgefahr oder schwere Verletzungsgefahr. Stellen Sie sicher, dass die vom Werk mitgelieferte Klebeisolierung für alle Anwendungen, bei denen kein Zubehör zur Auslösesperre verwendet wird, angebracht ist. Setzen Sie den Leistungsschalter nicht ohne die Isolierung ein.		Danger d'arc. Danger des mort ou risque de blessures graves. Vérifier que l'isolateur autocollant fourni soit en place pour toutes les applications sans interverrouillage de déclenchement. Ne pas utiliser le disjoncteur si l'isolateur manque.	
ES	 <b>PELIGRO</b>	IT	 <b>PERICOLO</b>
Peligro de arco eléctrico. Puede causar la muerte o lesiones graves. Cerciórese de que el aislador adhesivo suministrado de fábrica esté colocado para todas las aplicaciones en las que no se use un accesorio de enclavamiento de disparo. No aplique el interruptor si se ha perdido el aislador.		Pericolo di formazione d'arco elettrico. Può provocare la morte o gravi lesioni. Assicurarsi che l'isolamento adesivo fornito sia utilizzato per tutte le applicazioni senza un blocco di attivazione. Non utilizzare l'interruttore automatico se manca l'isolamento.	
PT	 <b>PERIGO</b>	TR	 <b>TEHLİKE</b>
Perigo de formação de arco voltaico. Perigo de morte ou ferimentos graves. Certifique-se de que o elemento isolante adesivo, tal como fornecido pela fábrica, está colocado para todas as aplicações que não utilizam um acessório de bloqueio da ativação. Não ative o disjuntor se o elemento isolante estiver em falta.		Kıvılcım tehlikesi. Ölüm ya da ciddi yaralanmaya sebebiyet verir. Fabrikadan temin edilen yapıştırıcı yalıtkan maddenin güvenlik kilidi olmayan tüm alanlara uygulandığından emin olun. Yalıtkan madde yoksa kesiciyi kullanmayın.	
РУ	 <b>ОПАСНО</b>	PL	 <b>ZAGROŻENIE</b>
Опасность электрической дуги. Может привести к смерти или серьезным травмам. Позаботьтесь о наличии клейкой изоляции в том виде, в котором поставляется изготовителем, для всех приложений, не использующих аварийные устройства отключения.		Ryzyko wyładowań łukowych. Mogą powodować utratę życia lub poważne obrażenia. W przypadku wszelkich zastosowań niewymagających użycia samowyzwalacza blokującego należy się upewnić, że izolacja samoprzylepna jest na swoim miejscu, tak jak było w stanie fabrycznym. Proszę nie stosować wyłącznika, jeśli nie ma izolacji.	
中	 <b>危険</b>	HR	 <b>OPASNOST</b>
电弧危险。将导致死亡或重伤。确保将出厂时随附的粘性绝缘体正确应用于未采用跳闸互锁附件的所有应用。请勿在缺少绝缘体的情况下应用断路器。		Opasnost od iskrenja. Opasnost po život ili opasnost od teških ozljeda. Svakako upotrijebite ljepljivi izolator, koji je isporučen iz tvornice, za svaku primjenu koja nema sigurnosnu sklopku za blokiranje aktivacije. Ne koristite prekidač ako nema izolatora.	
FI	 <b>VAARA</b>	БГ	 <b>ОПАСНОСТ</b>
Valokaaren vaara. Seurauksena on vakava loukkaantumisen tai kuolema. Varmista, että tarttuva eriste, joka on toimitettu tehtaalta, on paikallaan kaikkia sellaisia käyttötarkoituksia varten, joissa ei käytetä suojareleisävarustetta. Älä käytä katkaisijaa, jos eriste puuttuu.		Опасност от електрическа дъга. Може да причини смърт или сериозни наранявания. Уверете се, че фабрично предоставеният залепящ се изолатор е на мястото си при всички приложения, за които не се използва блокиращо потока устройство. Не поставяйте прекъсвач, ако изолаторът липсва.	
EE	 <b>OHT</b>	LV	 <b>BĪSTAMI</b>
Keevitускаare oht. Võib olla eluohutlik või tekitada tõsiseid vigastusi. Veenduge, et tehase väljastatud kleepuv isolaator oleks paigaldatud kõigiks rakendusteks, kus ei kasutata rakendumisvastast lukku (lisavarustus). Kui isolaator puudub, ärge rakendage kaitset.		Lokāzīlādes risks. Izraisa nāvi vai smagus miesas bojājumus. Nodrošiniet, lai līmējamais izolators būtu tādā stāvoklī, kādā tas piegādāts no ražotnes, un tas tiktu izmantots visām ierīcēm, kam nav atslēgšanas bloķēšanas piederuma. Neizmantojiet jaudas slēdzi bez izolatora.	





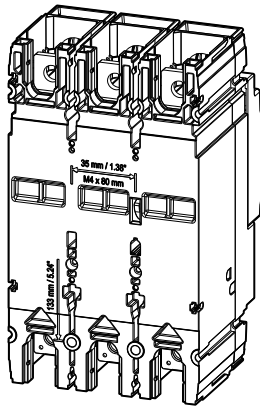
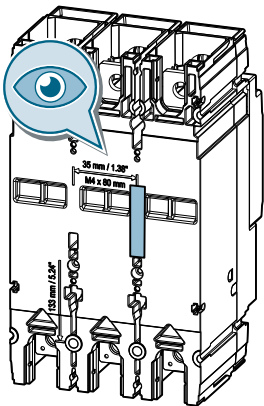

LT	<b>⚠️ PAVOJUS</b> Lanko susidarymo pavojus. Sukels mirtį arba rimtą sužalojimą. Įsitikinkite, kad lipnūs izoliatoriai, pateikiamas iš gamyklos, yra savo vietoje visais naudojimo atvejais, kai nenaudojamas atskyriklio blokavimo priedas. Nenaudokite pertraukiklio, jei nėra izoliatoriaus.	DA	<b>⚠️ FARE</b> Lysbud fare. Forårsager død eller alvorlige kvæstelser. Sørg for, at den hæftende isolator, som leveret fra fabrikken, er sat på alle anvendelser, der ikke bruger en låseenhed. Brug ikke afbryderen, hvis isolatoren mangler.
MT	<b>⚠️ PERIKLU</b> Periklu ta' arkjar (arcing). Dan jista' jikkawża mewt jew korrimenti gravi. Iżgura li l-izolament adegiv ipprovdut mill-fabbrika huwa mwaħħal għall-applikazzjonijiet kollha li m'għandhomx aċċessorju protettiv li jinterlokka jew jiskatta. Tinstallax breaker jekk m'hemmx izolament.	NL	<b>⚠️ GEVAAR</b> Gevaar van vonken. Leidt tot de dood of ernstig letsel. Zorg er beslist voor dat de plak-isolator, zoals door de fabriek geleverd, op zijn plaats aanwezig is voor alle toepassingen die geen accessoire voor activeringsblokkering gebruiken. Pas de onderbreker niet toe als de isolator ontbreekt.
EL	<b>⚠️ ΚΙΝΔΥΝΟΣ</b> Κίνδυνος σπινθηρισμών. Προκαλείται θάνατος ή σοβαρός τραυματισμός. Βεβαιωθείτε ότι ο μονωτής κόλλας, όπως τον προμηθεύει το εργοστάσιο, είναι σε θέση για όλες τις εφαρμογές χωρίς να χρησιμοποιείται αξεσουάρ μανδάλωσης. Μην εφαρμόζετε θραυστήρα εάν λείπει το μονωτικό.	GA	<b>⚠️ CONTÚIRT</b> Baol stuála. Beidh sé ina chúis bháis nó tromghortaithe Cinntigh go bhfuil an t-inslitheoir greamaitheach, mar a soláthraíodh ón mhonarchain é, suite do gach gaireas nach n-úsáideann oiriúint chomhghlasáil tuislithe. Ná feidhmigh scóránán má tá an t-inslitheoir in easnamh.
RO	<b>⚠️ PERICOL</b> Pericol de arc electric. Acesta va provoca decesul sau o vătămare gravă. Asigurați-vă că izolația adezivă livrată din fabrică este la locul său pentru toate aplicațiile în care nu se folosește un accesoriu de interblocare a declanșatoarelor. Nu aplicați întrerupătorul dacă lipsește izolația.	SV	<b>⚠️ FARA</b> Överslagsrisk. Kommer att orsaka dödsfall eller allvarliga personskad. Se till att den vidhäftande isolatorn, som levereras från fabriken, är på plats för alla applikationer som inte använder en utlösningmekanism för brytare. Använd inte brytare om isolatorn saknas.
SK	<b>⚠️ NEBEZPEČENSTVO</b> Nebezpečnostvni vzniku el. oblúka. Nebezpečnostvni ohrozenia života alebo vzniku vážnych zranení. Zabezpečte, aby pri všetkých aplikáciách ktoré nevyužívajú zariadenia núdzového odstavenia sa použil adhézný izolátor tak, ako je dodaný z výroby. Ak izolátor chýba, istič nezapínajte.	SL	<b>⚠️ NEVARNOST</b> Nevarnost iskrenja. Nevarnost za življenje ali nevarnost hudih poškodb. Gondoskodjon róla, hogy a gyárilag biztosított ragasztós szigetelő minden kioldóberendezés használatánál alkalmazásnál a helyén legyen. Ne használja a megszakítót, ha a szigetelő hiányzik.
CZ	<b>⚠️ NEBEZPEČÍ</b> Nebezpečí vzniku elektrického oblouku. Může způsobit usmrčení nebo vážné poranění. Dbejte na to, aby při všech aplikacích bez použití vypínacího blokovacího prvku byl na zařízení umístěn nalepovací izolátor dodaný z výroby. Nespínejte jistič, pokud izolátor chybí.	HU	<b>⚠️ VESZÉLY</b> Ívkiülés veszélye. Halált vagy komoly sérülést okoz. Ahogy már említettük, az adott alkalmazási paramétereknek megfelelő szigetelési módot kell alkalmazni.

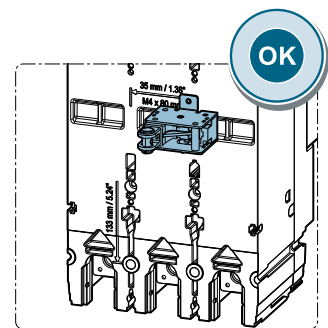
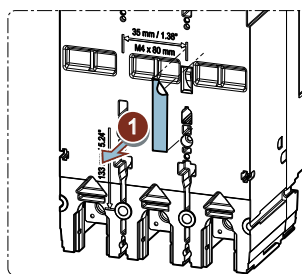

3VA9078 - 0VM10  
3VA9078 - 0VM30



	<b>EN</b>  <b>DANGER</b> <b>Hazardous voltage. Will cause death or serious injury.</b> Turn off and lock out all power supplying this device before working on this device. Replace all covers before power supplying this device is turned on.
<b>ES</b>  <b>PELIGRO</b> <b>Tensión peligrosa. Puede causar la muerte o lesiones graves.</b> Antes de trabajar en este dispositivo, desconecte y bloquee todas las fuentes que lo alimentan eléctricamente. Recoloque todas las cubiertas antes de volver a conectar la alimentación eléctrica para este dispositivo.	<b>FR</b>  <b>DANGER</b> <b>Tension électrique dangereuse. Danger de mort ou risque de blessures graves.</b> Avant d'intervenir sur l'appareil, couper toutes les sources de tension et les consigner contre la refermeture. Remettez en place tous les couvercles avant de remettre l'appareil sous tension.

**Information / Information / Informations / Información / 信息**

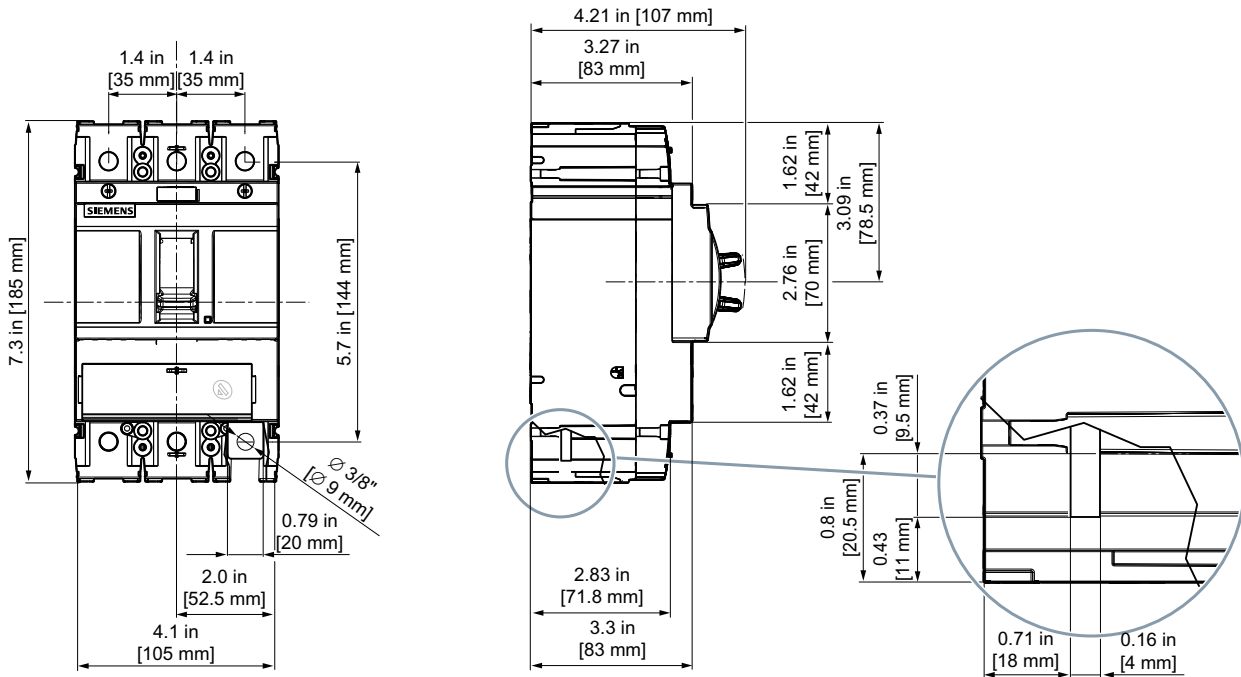

**Assembly / Montage / Montage / Montaje / 安装**

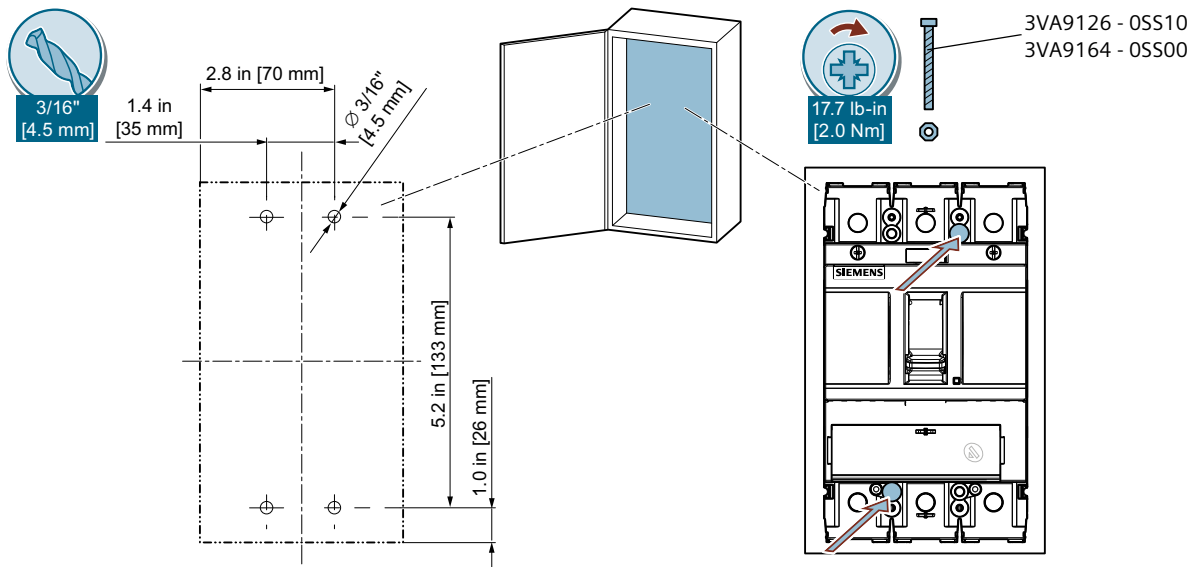



## Assembly / Montage / Montage / Montaje / 安装

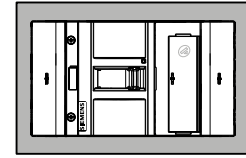
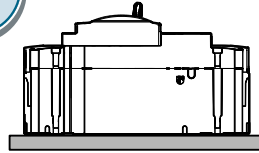
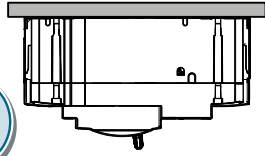
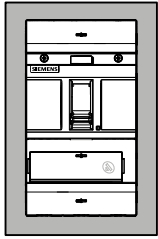

EN

### NOTICE

These instructions do not purport to cover all details or variations in equipment, or to provide for every possible contingency in connection with installation, operation, or maintenance. Should additional information be desired, please contact the local Siemens sales office. The contents of this instruction manual shall not become part of or modify any prior or existing agreement, commitment, or relationship. The sales contract contains the entire obligation of Siemens. The warranty contained in the contract between the parties is the sole warranty of Siemens. Any statements contained herein do not create new warranties or modify the existing warranty.

Trademarks - Unless otherwise noted, all names identified by ® are registered trademarks of Siemens AG or Siemens Industry, Inc. The remaining trademarks in this publication may be trademarks whose use by third parties for their own purposes could violate the rights of the owner.