

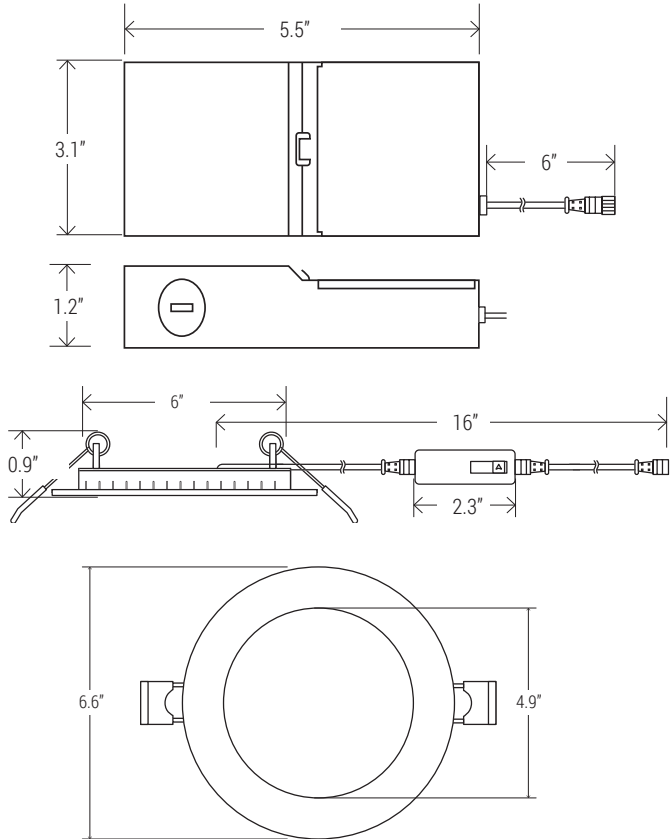

EASY 5 COLORS
SELECCTOR
2700K • 3000K • 3500K • 4000K • 5000K



NOMINAL LUMENS	DELIVERED LUMENS	WATTAGE
700	847	12W
1100	1235	14W

Based on 4000K, 90+ CRI. Actual wattage may vary +/- 5%

INSTALLATION

Cut hole in ceiling. Insert luminaire into opening by squeezing spring clips on both sides of luminaire. The width in ceiling needed for the driver to fit is 3".

You **MUST** seal all gaps between the ceiling and fixture with weatherproof silicone sealant. This deters moisture and water from damaging fixtures and other mechanical ceiling elements.

FEATURES

6" round multi-CCT LED "Slim Disk" engineered for new construction, remodel, or retrofit to accommodate insulated or dropped ceilings. Easily access field-adjustable 5-Color SeleCCTOR switch by lowering the luminaire from the opening. Recessed housing not required, especially with limited plenum applications. Remote driver allows easy installation and maintenance. Small aperture and shallow depth are ideal for unlimited applications.

LUMENS	700, 1100
CCT	27K/30K/35K/40K/50K
CRI	90+
COLOR QUALITY	3-Step MacAdam Ellipse
CONSTRUCTION	Aluminum die-cast body and trim
TRIM OPTION	Round Flat Lens
TRIM COLORS	WH (White), BK (Black), BZ (Bronze), SN (Satin Nickel), CP (Copper), CH (Chrome)
DIMMING	DIMTR (Triac), DIM10 (0-10V)
EMERGENCY	16W high voltage inverter (remote)
LIFETIME	L70 at 50,000 Hours
PHOTOMETRIC TESTS	In Accordance with IES LM79-08, LM80 and TM-30, TM-21

- IC-rated and Air-Tight ready and may be in direct contact with insulation.
- Can be installed in shallow plenum spaces.
- May be installed in drywall or suspended ceilings.
- Flicker-free 120V forward-phase dimming down to 5%.
- Even illumination achieved with patent-pending optics and edge-lit LED technology.
- Ideal where ceiling or top access is unavailable.



SLIM TRIM



TRIM RINGS



RL675-RT-BK
(Black)



RL675-RT-BZ
(Bronze)



RL675-RT-CH
(Chrome)



RL675-RT-CP
(Copper)



RL675-RT-SN
(Satin Nickel)

ACCESSORIES



RL-ACC-SLIM-1-10F
10-ft long extension



RL-ACC-SLIM-1-20F
20-ft long extension



RL-UNV-4/5/6
For use with: 4", 5", 6"
Universal mounting plate

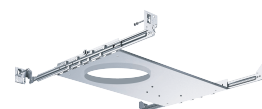
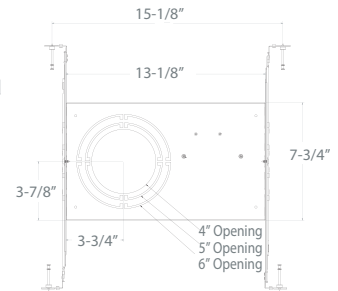

AL-ACC-SLIM-6-F-ROUGHPLATE
For use with: 6" downlights

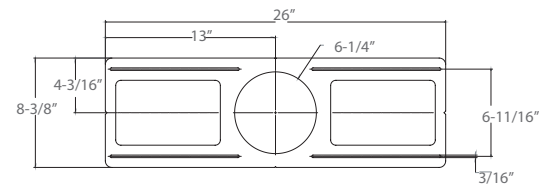
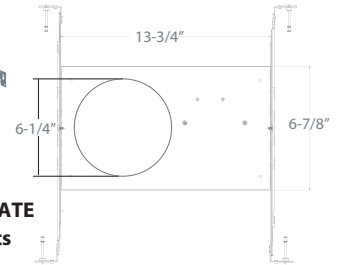

RL-ACC-SLIM-6-ROUGHPLATE
Rough-in plate for use with 6" downlights

EXAMPLE:
RL675-700L-DIMTR-120-27K/30K/35K/40K/50K-90-WH

TYPE	LUMEN	CCT	CRI	FINISH
RL675	<input type="checkbox"/> 700L-DIMTR-120 <input type="checkbox"/> 1100L-DIMTR-120 <input type="checkbox"/> 1100L-DIM10-120-347	<input type="checkbox"/> 27K/30K/35K/40K/50K	<input type="checkbox"/> 90+	<input type="checkbox"/> WH - White

RL675-RT-BZ

ACCESSORIES
<input type="checkbox"/> RL675-RT-BZ - Bronze <input type="checkbox"/> RL675-RT-BK - Black <input type="checkbox"/> RL675-RT-CH - Chrome <input type="checkbox"/> RL675-RT-CP - Copper <input type="checkbox"/> RL675-RT-SN - Satin Nickel

RL-ACC-SLIM-1-10F

OPTIONS
<input type="checkbox"/> RL-ACC-SLIM-1-10F - 10ft Long Extension <input type="checkbox"/> RL-ACC-SLIM-1-20F - 20ft Long Extension <input type="checkbox"/> RL-UNV-4/5/6 - Universal Mounting Plate for 4", 5" and 6" <input type="checkbox"/> RL-ACC-SLIM-6-F-ROUGHPLATE - 6" Mounting Plate <input type="checkbox"/> AL-ACC-SLIM-6-F-ROUGHPLATE - 6" Flanged Roughplate

RL675-700L-DIMTR-120-27K-30K-35K-40K-50K-90-WH

TEST NO.: **EL12191972**

INPUT WATTS: **11.5489**

LUMENS: **847**

CRI: **90**

EFFICACY: **73**

CCT: **4000K**

SPACING CRITERIA: **1.18**

Candle Power Distribution (Candelas)

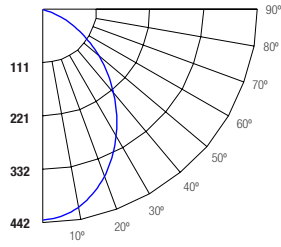

Zonal Lumens Summary

Zone	Lumens	%Lamp	%Fixt
0-20	155.70	18.40	18.40
0-30	316.70	37.40	37.40
0-40	491.20	58.00	58.00
0-60	763.72	90.20	90.20
0-80	845.87	99.90	99.90
0-90	845.91	99.90	99.90

Luminance Data (cd/sq.m)

Angle In Degrees	Average 0°	Average 45°	Average 90°
45°	94050	94233	97574
55°	72140	72749	76682
65°	46168	47375	52226
75°	12895	15196	21161
85°	118	118	118

Lumens Per Zone

Zone	Lumens
0-10	41.42
10-20	114.27
20-30	161.00
30-40	174.50
40-50	156.62
50-60	115.90
60-70	64.68
70-80	17.47
80-90	0.04

Candela Tabulation

0	1	2	3	4	5	6	7	8	9	10
0	442.00	436.50	402.04	343.89	271.40	194.28	120.88	57.00	9.75	0.03
90	85	80	0.03	0.03						

Coefficients of Utilization - Zonal Cavity Method
Effective Floor Cavity Reflectance 0.20

Cone of Light			
2	111	3.7	3.7
4	27.6	7.4	7.4
6	12.3	11.1	11.1
8	6.91	14.8	14.7
10	4.42	18.4	18.4
12	3.07	22.1	22.1

(FT.) Distance to Plane (FC.) Initial Footcandle at Nadir (FT.) Beam Vert. Spread (FT.) Beam Horiz. Spread
BEAM DIA. MEASURED AT 50% OF NADIR F.C.

ROOM CAVITY RATIO	RC		80%			70%			50%			30%			10%			0%		
	RW	70%	50%	30%	10%	70%	50%	30%	10%	50%	30%	10%	50%	30%	10%	50%	30%	10%	0%	
0	119	119	119	119	119	116	116	116	116	111	111	111	106	106	106	102	102	102	100	
1	111	107	104	101	101	108	105	102	99	101	98	96	97	95	93	93	92	90	88	
2	103	96	90	85	85	100	94	89	84	90	86	82	87	84	80	84	81	79	77	
3	95	86	79	73	73	92	84	78	72	81	76	71	79	74	70	76	72	69	67	
4	88	77	69	64	64	85	76	69	63	73	67	62	71	66	61	69	64	61	59	
5	81	70	62	56	56	79	69	61	56	67	60	55	65	59	54	63	58	54	52	
6	75	63	55	50	50	74	62	55	49	61	54	49	59	53	49	58	52	48	46	
7	70	58	50	44	44	69	57	50	44	56	49	44	54	48	44	53	48	43	42	
8	66	53	45	40	40	64	53	45	40	51	45	40	50	44	40	49	43	39	38	
9	62	49	42	36	36	60	49	41	36	48	41	36	46	40	36	46	40	36	34	
10	58	46	38	33	33	57	45	38	33	44	38	33	43	37	33	42	37	33	31	

RC - Ceiling Cavity Reflectance RW - Wall Reflectance

RL675-1100L-DIMTR-120-27K-30K-35K-40K-50K-90-WH

TEST NO.: **EL11121926**

INPUT WATTS: **14.8497**

LUMENS: **1235**

CRI: **90**

EFFICACY: **83**

CCT: **4000K**

SPACING CRITERIA: **1.20**

Candle Power Distribution (Candelas)

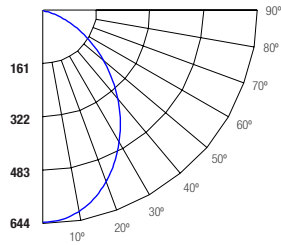

Zonal Lumens Summary

Zone	Lumens	%Lamp	%Fixt
0-20	226.95	18.40	18.40
0-30	462.15	37.40	37.40
0-40	717.60	58.10	58.10
0-60	1116.75	90.40	90.40
0-80	1233.88	99.90	99.90
0-90	1233.92	99.90	99.90

Luminance Data (cd/sq.m)

Angle In Degrees	Average 0°	Average 45°	Average 90°
45°	141466	143006	146482
55°	108819	111284	116034
65°	69859	73415	79514
75°	20619	24415	33712
85°	157	118	118

Lumens Per Zone

Zone	Lumens
0-10	60.34
10-20	166.61
20-30	235.20
30-40	255.45
40-50	229.73
50-60	169.42
60-70	93.10
70-80	24.03
80-90	0.04

Candela Tabulation

0	1	2	3	4	5	6	7	8	9	10
0	643.02	637.26	590.83	508.93	404.97	292.23	182.34	86.25	15.59	0.04
90	85	80	0.04	0.04						

Coefficients of Utilization - Zonal Cavity Method
Effective Floor Cavity Reflectance 0.20

Cone of Light			
2	161	3.7	3.7
4	40.2	7.4	7.4
6	17.9	11.2	11.2
8	10	14.9	14.9
10	6.43	18.6	18.6
12	4.47	22.3	22.3

(FT.) Distance to Plane (FC.) Initial Footcandle at Nadir (FT.) Beam Vert. Spread (FT.) Beam Horiz. Spread
BEAM DIA. MEASURED AT 50% OF NADIR F.C.

ROOM CAVITY RATIO	RC		80%			70%			50%			30%			10%			0%		
	RW	70%	50%	30%	10%	70%	50%	30%	10%	50%	30%	10%	50%	30%	10%	50%	30%	10%	0%	
0	119	119	119	119	119	116	116	116	116	111	111	111	106	106	106	102	102	102	100	
1	111	107	104	101	101	108	105	102	99	101	98	96	97	95	93	93	92	90	88	
2	103	96	90	85	85	100	94	89	84	91	86	82	87	84	81	84	81	79	77	
3	95	86	79	73	73	92	84	78	73	81	76	71	79	74	70	76	72	69	67	
4	88	77	69	64	64	85	76	69	63	73	67	62	71	66	62	69	65	61	59	
5	81	70	62	56	56	79	69	61	56	67	60	55	65	59	54	63	58	54	52	
6	75	63	55	50	50	74	63	55	49	61	54	49	59	53	49	58	52	48	46	
7	70	58	50	44	44	69	57	50	44	56	49	44	54	48	44	53	48	43	42	
8	66	53	46	40	40	64	53	45	40	51	45	40	50	44	40	49	44	39	38	
9	62	49	42	36	36	60	49	41	36	48	41	36	47	40	36	46	40	36	34	
10	58	46	38	33	33	57	45	38	33	44	38	33	43	37	33	42	37	33	31	

RC - Ceiling Cavity Reflectance RW - Wall Reflectance