

Deltec cable support system

Lashing straps and accessories

The Deltec cable support system is a user-friendly product designed to provide ease and flexibility in fastening communications cables to messenger strand. It is equally well suited for copper conductor cable, coaxial cable, fiber optic cable and innerduct in aerial applications.



Strong, long-life and cost-saving method of securing communication cables

The Deltec system answers your aerial cable needs with innovative design and state-of-the-art materials. This system includes weather-resistant acetal cable straps, marine grade locking devices, and base hanger accessories for specific applications where mounting is required.

Pre-assembled Deltec cable straps are available in standard lengths of 10 in. (254 mm), 13.5 in. (342.9 mm), and 27 in. (685.8 mm). Convenient 50 ft. (15.24 m) to 3500 ft. (1066.8 m) reels where specific lengths need to be established by the installer in the field are available. Additional "standard" lengths can be established for applications where higher volumes prevail.

Extra security !

The recommended maximum continuous static loading for the Deltec straps is 20 lb. per strap. For best results, suggested spacing is 15 in. It's the responsibility of the user to determine whether or not their application meets our recommendation.

Advantages of the Deltec System Include:

- Proven years of service
- No sharp edges – craft friendly Cable friendly!
- Ease of installation – one wrap, no re-treading or re-strap
- Lowers installation costs
- High tensile strength after fastening
- Total flexibility in lengths when using reel
- Stackable spacers accommodate all cable sizes – no need to stock multiple sizes of individual height spacers
- Spacer designed to retain strap on each side and cradle the cable, providing restricted movement of spacer and preventing damage to cable
- In situations where multiple cables are supported, the ABB TCP360 stackable spacer may be rotated 90° and installed similarly to a single cable, yet provide the same restricting features (unlike those commonly used today)
- Month and year of manufacture stamped into strap material
- Squirrels and vermin won't eat it!



Deltec cable support system

Pre-assembled Deltec cable ties



Characteristics

- Provides a strong, long-life and cost saving method of securing communication and overhead cables
- Double locking head with corrosion resistant locking barbs in copper alloy
- Proven years of service: designed to last a minimum of 20 years outdoor
- No sharp edges: operator friendly, cable friendly!
- Easy to install, low installation costs
- Extremely robust ties, with high tensile strength (1110N) after fastening
- Choice of specific spacers and accessories
- Superior resistance to moisture and salt environments

Technical information

- Material - Strap & head: Toughened weatherable acetal
- Material - Locking barb: Marine grade, corrosionresistant copper alloy
- Temperature range: -65°C to +90°C (-85°F to 194°F)
- Flammability rating: UL 94 HB
- Colour: Black
- Halogen free

Pre-assembled Deltec cable ties

Cat. n°.	ANSI UL94 Flame rating	Max. wire bundle dia.		Length L		Width W		Tensile strength		Std. pkg. [pcs]
		[mm]	[in.]	[mm]	[in.]	[mm]	[in.]	[lb]	[N]	
CSS-100	HB	76.2	3	254.0	10	12.7	0.5	250	1,110	50
CSS-135	HB	88.9	3.5	342.9	13.5	12.7	0.5	250	1,110	50
CSS-160	HB	101.6	4	406.4	16	12.7	0.5	250	1,110	50
CSS-270	HB	200	7.87	685.8	27	12.7	0.5	250	1,110	10

Note: the recommended maximum continuous static loading for the Deltec straps is 90 N per strap.
For best results suggested spacing is 35 to 40cm.
It is the responsibility of the user to determine whether or not their application meets our recommendation.

Tooling



WT3D

For use with 12.7mm
(1110N) Cable ties.
See page C42.

Diagrams

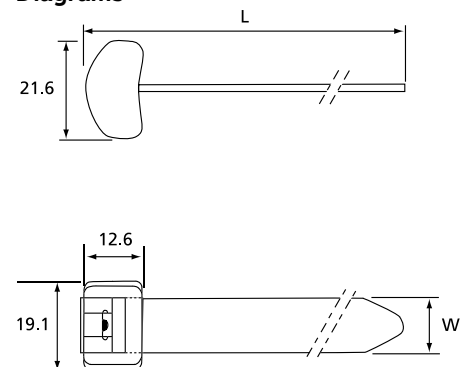

Deltec cable support system

Strap on reel & double locking heads



Characteristics

- Strap on reel, with separate head
- Total flexibility & no waste: cut at the desired length
- Easy to store: reduced inventory
- Convenient kits containing several reels of strap and separate locking heads, to provide all you need to be efficient on the field
- 2 configurations to match your need
- Superior resistance to UV rays, to moisture and salt environments

Technical information

- Material - Strap & head: Toughened weatherable acetal
- Material - Locking barb: Marine grade, corrosionresistant copper alloy
- Temperature range: -40°C to +85°C (-40°F to 185°F)
- Flammability rating: UL 94 HB
- Colour: Black
- Halogen free

Strap on reel

Cat. n°.	ANSI UL94 Flame rating	Length per reel			Width [in.]	Min. tensile strength		Std. pkg. reel [pcs]	Std. pkg. heads [pcs]
		[m]	[pi]	[mm]		[lb]	[N]		
CSS-5K	HB	15	50	12.7	0.5	250	1,110	5	150
CSS-10K	HB	15	50	12.7	0.5	250	1,110	5	300
TYD-50R	HB	15	50	12.7	0.5	250	1,110	1	-
696-41794	HB	305	1,000	12.7	0.5	250	1,110	1	-

Note: the recommended maximum continuous static loading for the Deltec straps is 90 N per strap.

For best results suggested spacing is 35 to 40cm. It is the responsibility of the user to determine whether or not their application meets our recommendation.

Tooling



WT3D

For use with 12.7mm (1110N) Cable ties.
See page C42.



Technical information

- Material: Toughened weatherable acetal
- Material - locking barb: Marine grade, corrosion-resistant copper alloy
- Superior resistance to UV rays, to moisture and salt environments
- Temperature range: -40°C to +85°C (-40°F to +185°F)
- Flammability rating: UL 94 HB
- Colour: Black
- Halogen free

Double locking heads

Std. Cat. N°.	Bulk Cat. N°.	ANSI UL94 Flame rating	Length L			Width W [in.]	Height H [mm]	Std. pkg. [pcs]	Bulk pkg. [pcs]	
			[mm]	[in.]	[mm]					
TYD-LH	696-41795	HB	21.6	0.85	19.1	0.75	12.6	0.50	25	1,000

To be assembled with Deltec strap on reel

Diagrams

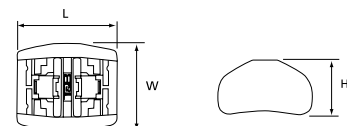

Deltec cable support system

Modular stackable cable spacers



Characteristics

- Stackable, 0.5 in (12.7 mm) high each, to achieve desired spacing regardless of cable diameter - no need to store a multitude of spacers of different heights
- Designed to hold and support each side of the cable, limiting movement of the spacer to prevent damage to the cable
- Ideal for coaxial cables (TCP360)
- Can be used for parallel or perpendicular cable routing

Technical information

- Material: weather-resistant polypropylene
- Temperature range: -40°C to +85°C (-40°F to +185°F)
- Flammability rating: UL 94 HB
- Colour: Black
- Halogen free

Spacers

Std. Cat. N°.	Bulk Cat. n°.	ANSI UL94 Flame rating	Length L		Width W		Height H		Std. pkg. [pcs]	Bulk pkg. [pcs]
			[mm]	[in.]	[mm]	[in.]	[mm]	[in.]		
TCP5255	TCP360	HB	53.3	2.10	30.5	1.20	12.7	0.5	25	100

Diagrams

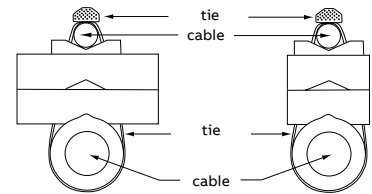
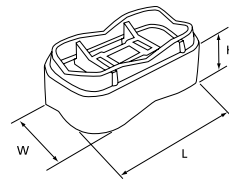

Cable support system with metallic locking barb

Base and hanger



Characteristics

- Secures cables to all types of surfaces

Technical information

- Material: zinc-plated steel

Base and hanger

Cat. n°.	Dimensions										Dia. from the hole fixation		Std. pkg. [pcs]
	A		B		C		D		E		[mm]	[in.]	
	[mm]	[in.]	[mm]	[in.]	[mm]	[in.]	[mm]	[in.]	[mm]	[in.]			
CSS-B	48.4	1.91	14.3	0.56	7.1	0.28	15.1	0.59	5.6	0.22	6.7 (2x)	0.26 (x2)	50
CSS-H	22.5	0.89	22.2	0.87	29.8	1.17	13.6	0.54	8.3	0.33	6.9	0.27	50

Must be assembled with Deltec on reels.

Diagrams

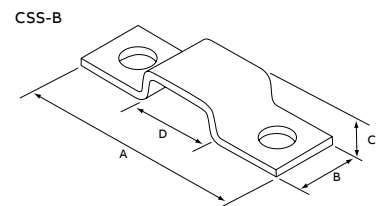
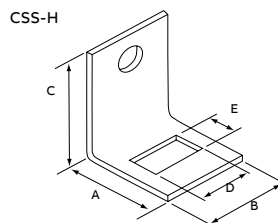

Deltec cable support system

Messenger hanger straps



Characteristics

- Very good resistance to ultraviolet rays, exposure to chemicals and weathering
- 2 practical kits containing several rolls of ties and separate heads to fully meet your needs on site

Technical information

- Material: polyamide 12
- Temperature range: -40°C to +80°C (-40°F to +176°F)
- Colour: Black



UV-resistant



Chemically resistant



Weather-proof

Messenger Hanger Straps

Cat. n°.	Max. wire bundle dia.		Length		Width		Material hook	Min. tensile strength		Std. pkg. [pcs]
	[mm]	[in.]	[mm]	[in.]	[mm]	[in.]		[lb]	[N]	
Weather-Resistant polyamide 12 messenger hanger straps (Releasable)										
TYM5412X	76	3	305	12	12.7	0.5	Bronze	200	890	50
TYM5418X	127	5	457	18	12.7	0.5	Bronze	200	890	25
TYM5423X	178	7	610	24	12.7	0.5	Bronze	200	890	25
TYM5430X	229	9	762	30	12.7	0.5	Bronze	200	890	25
TYM5436X	279	11	914	36	12.7	0.5	Bronze	200	890	25
TYM5412X-S	76	3	305	12	12.7	0.5	Stainless steel	200	890	50
TYM5418X-S	127	5	457	18	12.7	0.5	Stainless steel	200	890	25
TYM5423X-S	178	7	610	24	12.7	0.5	Stainless steel	200	890	25
TYM5430X-S	229	9	762	30	12.7	0.5	Stainless steel	200	890	25
TYM5436X-S	279	11	914	36	12.7	0.5	Stainless steel	200	890	25
Weather-resistant polyamide 12 hanger strap (Releasable)										
TY54407X	51	2	161	6,34	12.7	0.5	Steel	200	890	100
TY54413X	102	4	349	13,75	12.7	0.5	Steel	200	890	100

Note: The recommended maximum continuous static load for polyamide is 25 lbs (111 N) per strap.

For best results, the suggested spacing is 15 in. (38cm). It is the user's responsibility to determine whether or not their application meets our recommendations.

The hook hooks onto a ½ in. diameter carrier cable.

Deltec cable support system

Heavy-Duty lashing tie (Releasable)



Characteristics

- Black carbon provides good resistance to ultraviolet rays and also extends the service life of the clip
- One piece heavy duty ties
- Reusable, ideal for temporary installations
- Quick and durable installation
- Easily transportable
- No tools

Technical information

- Material: polyamide 6.6
- Temperature range: -40°C to +85°C (-40°F to +185°F)
- Flammability rating: UL 94 V-2
- Colour: Black
- Halogen free



UV-resistant



Weather-proof

Heavy-Duty lashing tie (Releasable)

Cat. n°. Std. pkg. / Emb. en nbr.	ANSI UL94 Flame rating	Wire bundle dia.		Length L		Width W		Min. tensile strength		Std. pkg. [pcs]	Bulk pkg. [pcs]
		[mm]	[in.]	[mm]	[in.]	[mm]	[in.]	[lb]	[N]		
TY5409 / TY409	V-2	45 - 121	1,77 - 4,76	483	19	12,7	0,5	200	890	25	100

Description of Cat. n°. structure: see page C13

Description of materials and properties: see pages C132 to C144

Diagrams

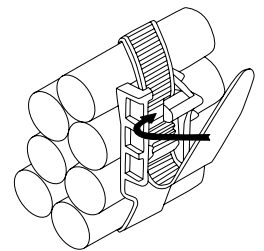
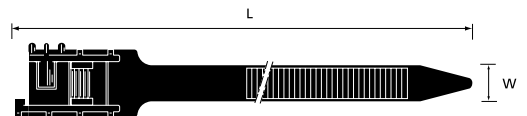

Introduce the cable tie tail into the lower slot in the head. Tighten the tie and pull it back. Slide in the tie under the catch from the side until it snaps into position.

Deltec cable support system

2-piece reusable attachment straps



Characteristics

- Heavy-duty lashing ties, in cut lengths with pre-assembled heads
- The strap is made of UV-resistant Polypropylene, ideal for applications where chemical resistance is important
- Extremely robust (670N)
- Easily releasable & reusable
- 2 types of head:
 - type A: no mounting hole,
 - type B: with mounting hole
- Typical applications: Indoor and outdoor fastening of cables, pipes and other parts in industry, shipbuilding, chemical industry etc

- Cat. n°. 696-41563: strap on reel of 300 meter, UV resistant polypropylene
- Cat. n°. 696-41562: separate head (without fixing hole), polyamide 6.6 UV resistant

Technical information

- Material - tie : weatherable Polypropylene
- Material - head : polyamide 6.6
- Temperature range:
 - strap: -55°C to +110°C (-67°F to +230°F)
 - head: -40°C to +85°C (-40°F to +185°F)
- Flammability rating: UL 94 V-2
- Colour: Black
- Halogen free

Releasable 2-piece lashing ties, pre-assembled version

Cat. n°.	ANSI UL94 Flame rating	Wire bundle dia.		Length L		Width W		Mounting hole diameter		Tensile strength		Std. pkg. [pcs]
		[mm]	[in.]	[mm]	[in.]	[mm]	[in.]	[mm]	[in.]	[lb]	[N]	
Weather-resistant polypropylene hanger lashing tie (Releasable)												
TY53418PX	UL 94 V-2	45 - 127	1.77 - 5	457	17.99	13.2	0.52	6.9	0,27	150	670	25
Weather-Resistant polypropylene lashing tie (Releasable)												
TY5418PX	UL 94 V-2	45 - 127	1.77 - 5	457	17.99	13.2	0.52	-	-	150	670	25
TY5424PX	UL 94 V-2	10 - 178	0.39 - 7.01	610	24.02	13.2	0.52	-	-	150	670	25
TY5442PX	UL 94 V-2	10 - 305	0.39 - 12.01	1.067	42.01	13.2	0.52	-	-	150	670	10
TY5460PX	UL 94 V-2	10 - 457	0.39 - 17.99	1.524	60	13.2	0.52	-	-	150	670	10

Description of Cat. n°. structure: see page C13

Description of materials and properties: see pages C132 to C144

Releasable 2-piece lashing ties on reel with separate heads

Cat. n°.	ANSI UL94 Flame rating	Max. wire bundle dia.		Length L		Width W		Tensile strength		Std. pkg. [pcs]
		[mm]	[in.]	[mm]	[in.]	[mm]	[in.]	[lb]	[N]	
696-41562	V-2	-	-	-	-	-	-	150	670	200
696-41563	V-2	45	1.8	300	1,000	13.2	0.5	150	670	1

Diagrams

TY54XXPX

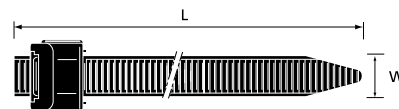
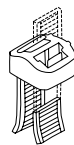

696-41563

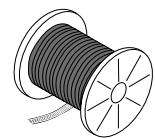

TY53418PX

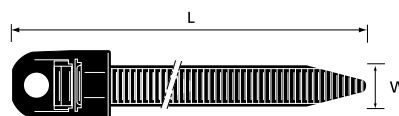
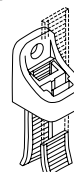

696-41562

