

# Mini-Com<sup>®</sup> High Density Modular Patch Panels

## specifications

High density modular patch panels shall consist of a metal panel with molded front or rear snap-in faceplates. Patch panels shall accept all Mini-Com<sup>®</sup> Modules for UTP, STP, A/V or select fiber and shall mount to standard 19" racks. Patch Panels shall be available in 32-port 1 RU), 48-port (1 RU) and 72-port (2 RU). Select styles shall be available in white. Flush mount panels shall be easy to identify with pre-numbered ports. Angled patch panels shall be designed at an optimum angle to help route the cable.

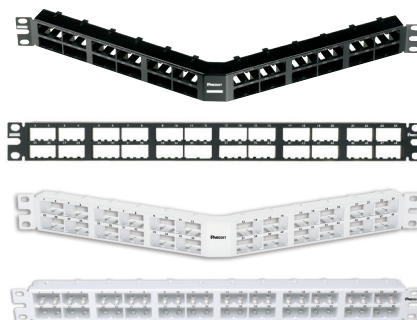

## technical information

<b>Mounting options:</b>	Mounts to standard 19" rack
<b>Material:</b>	Stamping is CRS and faceplate is ABS
<b>Packaging:</b>	Packaged with appropriate pre-installed snap in faceplates and a set of mounting screws (#12-24)

## key features and benefits

<b>Modular</b>	Panels with front snap-in faceplates will accept any Mini-Com <sup>®</sup> Modules and panels with rear snap-in faceplates will accept all UTP, STP, A/V and most fiber modules
<b>Angled design</b>	Minimizes the need for horizontal cable managers enabling patch cords to be routed directly into vertical cable managers which leads to increase closet density
<b>Port and panel identification</b>	Pre-numbered ports and labeling capabilities on select panels
<b>Optional strain relief bars</b>	To help support and manage cables
<b>Optional filler panels</b>	Flat and angled design fill unused rack openings to provide a clean and consistent look when used with any version of Panduit patch panels
<b>Optional extender bracket</b>	Allows 19" patch panels to be mounted on a 23" rack
<b>High density</b>	More modules per rack space
<b>Color options</b>	Select styles available in white, standard color is black

## applications

Mini-Com<sup>®</sup> High Density Patch Panels are ideal for multi-media applications. Flat and angled designs are available in various port densities to fit most needs. Flush mount style includes pre-numbered ports or area for adhesive labeling, select faceplate style panels with label pockets include pre-numbered labels and covers. Angled patch panels are available for applications

in which rack space is limited. The design allows cable to flow to each side of the rack, minimizing the need for horizontal cable managers and increasing the density of the rack space. High density patch panels can mount on a standard 19" rack or a 23" rack when using the extender brackets PEB1 or PEB2.

### Mini-Com<sup>®</sup> High Density Flat Style, Flush Mount

<b>Black</b>	
<b>48-port, 1 RU:</b>	CPP48HDWBLY*
<b>48-port, 1 RU (extended area for labeling):</b>	CPP48HDEWBL
<b>48-port, 1 RU (vertical numbering):</b>	CPP48HDVNSWBLY*
<b>72-port, 2 RU:</b>	CPP72FMWBLY

<b>White</b>	
<b>48-port, 1 RU:</b>	CPP48HDWWH*

### Mini-Com<sup>®</sup> High Density Angled Style, Flush Mount

<b>Black</b>	
<b>48-port, 1 RU:</b>	CPPA48HDWBLY*
<b>48-port, 1 RU (extended area for labeling):</b>	CPPA48HDEWBL
<b>48-port, 1 RU (vertical numbering):</b>	CPPA48HDVNSWBLY*
<b>72-port, 2 RU:</b>	CPPA72FMWBLY

<b>White</b>	
<b>48-port, 1 RU:</b>	CPPA48HDWWH*

### Mini-Com<sup>®</sup> High Density Patch Panels Faceplate Style

<b>32-port, 1 RU, flat:</b>	CPP32WBLY
<b>72-port, 2 RU, flat:</b>	CPPL72WBLY
<b>72-port, 2 RU, angled:</b>	CPPLA72WBLY

### Patch Panel Accessories

<b>Black</b>	
<b>Transitional cover:</b>	CPATCBL
<b>Angled filler panel, 1 RU:</b>	CPAF1BL
<b>Angled filler panel, 2 RU:</b>	CPAF2BL
<b>Flat filler panel, 1 RU:</b>	DPFP1
<b>Flat filler panel, 2 RU:</b>	DPFP2
<b>White</b>	
<b>Transitional cover:</b>	CPATCWH
<b>Angled filler panel, 1 RU:</b>	CPAF1WH
<b>Angled filler panel, 2 RU:</b>	CPAF2WH
<b>Flat filler panel, 1 RU:</b>	DPFP1WH
<b>Flat filler panel, 2 RU:</b>	DPFP2WH

### Extender Brackets

<b>1 RU:</b>	PEB1
<b>2 RU:</b>	PEB2

\* = Space not available for labeling

# Mini-Com® High Density Modular Patch Panels

Mini-Com® High Density Modular Patch Panels Label Chart

Part Number	Label Type	Replacement for Label Pocket	Laser/Ink	LS8	Thermal
CPP32WBLY	Adhesive	—	—	T024X000VPC-BK	T024X000FJT
CPP48HDEWBL					
CPP48HDEWWH					
CPP48HDWWH					
CPPA48HDEWBL					
CPPA48HDEWWH					
CPPA48HDWWH					
CPP72FMWBLY					
CPPA72FMWBLY					
CPPL72WBLY					
CPPLA72WBLY					

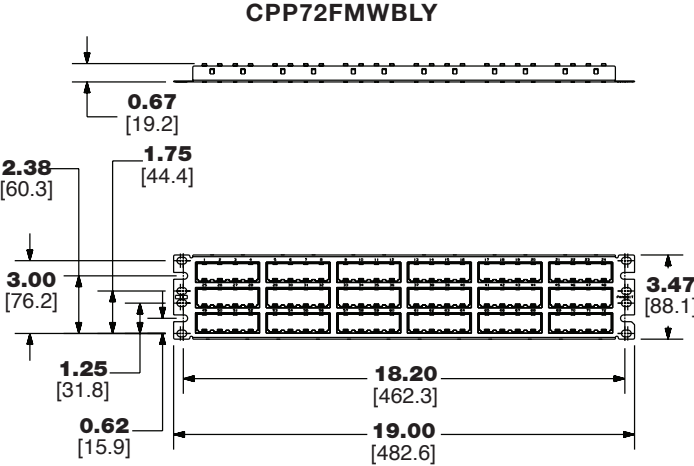
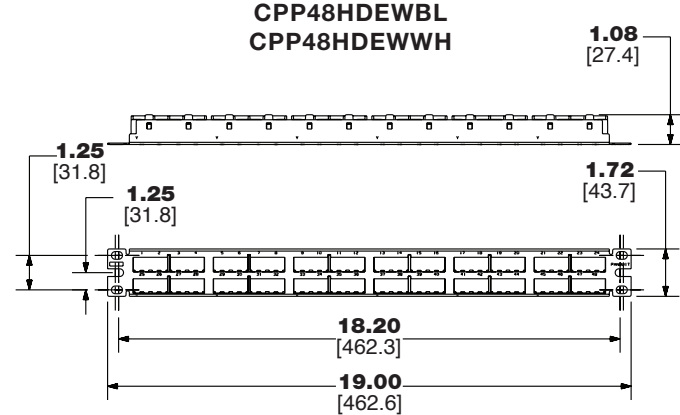
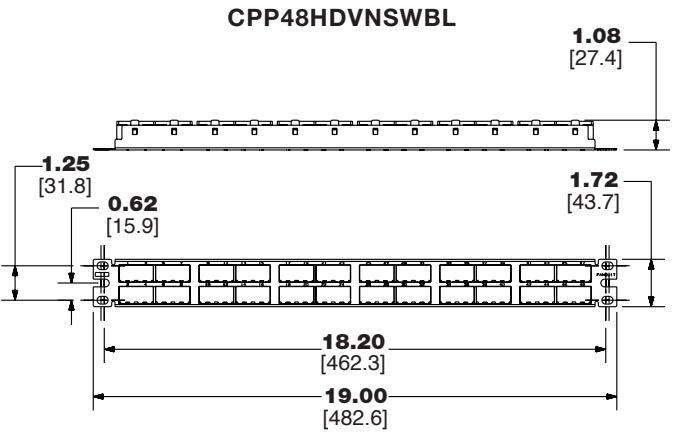
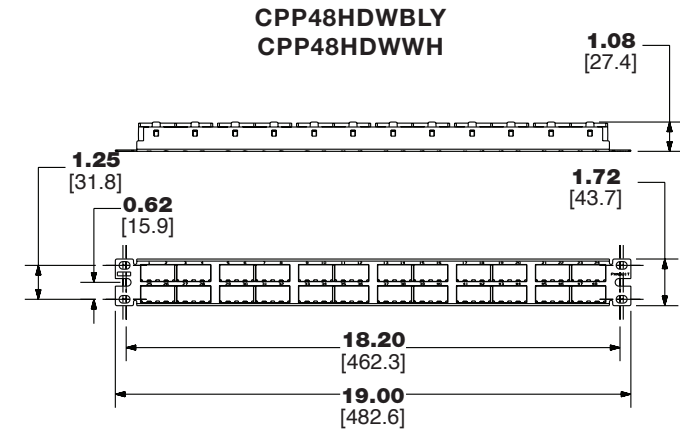
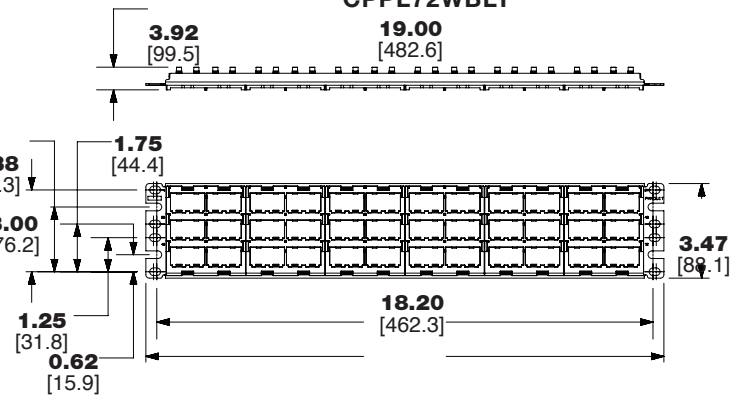
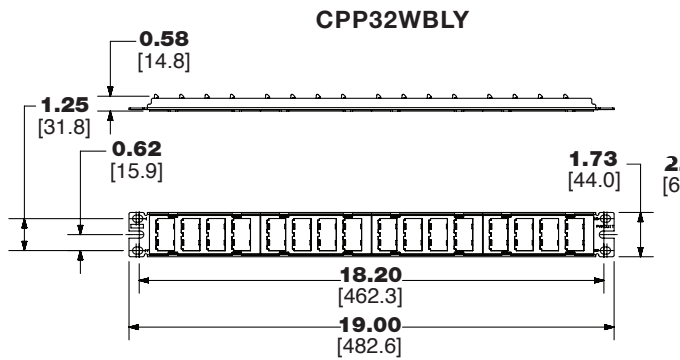

# Mini-Com<sup>®</sup> High Density Modular Patch Panels

**CPPA48HDWBL**  
**CPPA48HDWWH**

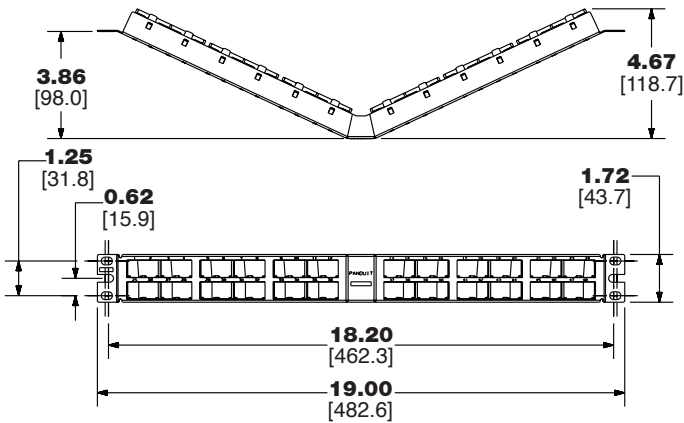

**CPPA48HDEWBL**  
**CPPA48HDEWWH**

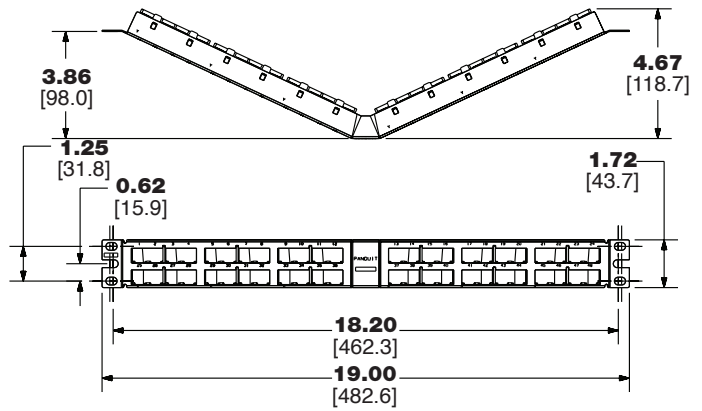

**CPPA48HDVNSWBL**

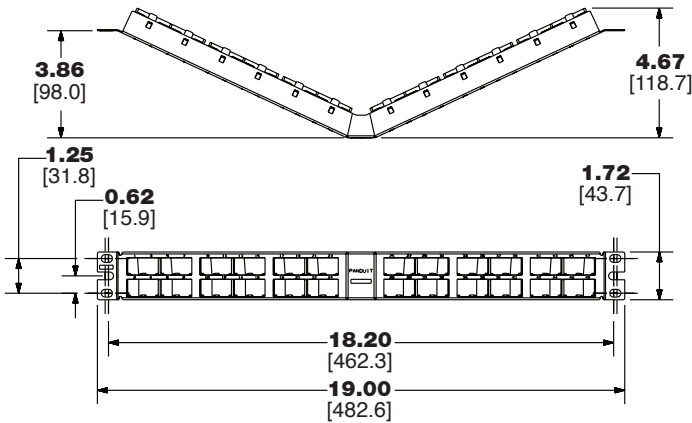

**CPPA72FMWBL**

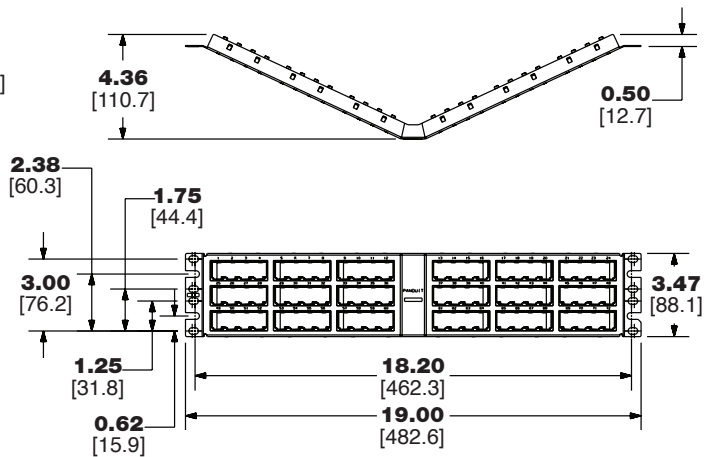

**CPPLA72WBL**

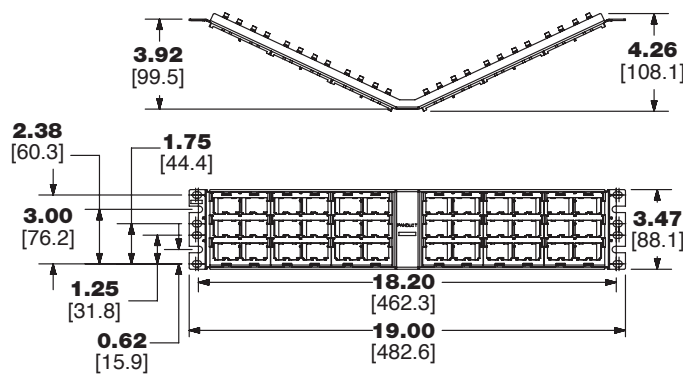

Dimensions are in inches. [Dimensions in brackets are metric].

## WORLDWIDE SUBSIDIARIES AND SALES OFFICES

PANDUIT US/CANADA  
Phone: 800.777.3300

PANDUIT EUROPE LTD.  
London, UK  
Phone: 44.20.8601.7200

PANDUIT SINGAPORE PTE. LTD.  
Republic of Singapore  
Phone: 65.6305.7575

PANDUIT JAPAN  
Tokyo, Japan  
Phone: 81.3.6863.6000

PANDUIT LATIN AMERICA  
Guadalajara, Mexico  
Phone: 52.33.3777.6000

PANDUIT AUSTRALIA PTY. LTD.  
Victoria, Australia  
Phone: 61.3.9794.9020

For a copy of Panduit product warranties, log on to [www.panduit.com/warranty](http://www.panduit.com/warranty)



For more information  
Visit us at [www.panduit.com](http://www.panduit.com)  
Contact Customer Service by email: [cs@panduit.com](mailto:cs@panduit.com)  
or by phone: 800.777.3300

© 2022 Panduit Corp.  
ALL RIGHTS RESERVED.  
OTSP49--WW-ENG  
4/2022