



The Advance Xitanium range of linear LED drivers is designed to provide OEMs with ultimate flexibility. These models are compatible with standard 0-10V dimming systems to deliver reliably smooth dimming performance down to a minimum of 1%. Enabled with SimpleSet technology, these drivers offer the needed flexibility and performance for the application with precise tuning of drive currents, selectable dimming curves and adjustable minimum dimming levels. With wide operating windows, slim profile and simple current adjustability, the drivers make it easy for luminaire manufacturers to design linear fixtures with desired lumen levels to suit the application.

Specifications

Input Voltage (Vac)	Output Power (W)	Output Voltage (V)	Output Current (A)	Efficiency @ Max Load and 75°C Case	Max Case Temp. (°C)	Input Current (A)	Max. Input Power (W)	THD @ Max Load (%)	Power Factor @ Max Load	Surge Protect. (Ring Wave, KV)	Envir. Protect. Rating	Dim.	Dimming Range (with specified dimmers)	Minimum Output Current (A)	Other Comments
120	20	10-54	0.1 - 0.56	86.0%	Life-75°C	0.2	24.8	<10%	>0.95	2.5	UL damp & dry	0-10V Analog Class 1 or Class 2 Wiring	1% - 100% (Constant Current)	0.001	Dimming source current: 150 µA
277				87.0%	UL-80°C	0.09		<15%							

Enclosure

	In. (mm)	Tolerance (mm)
Overall Length (A1)	11.02 (280)	± 0.5
Mounting Length (A2)	10.63 (270)	± 0.5
Case Length (A3)	8.81 (223.8)	± 0.5
Case Width (B1)	1.18 (29.4)	± 0.5
Case Height (C1)	1.0 (25.4)	± 1.0
Mounting Hole Diameter (D1)	0.31 (7.9)	± 0.3
Center of SimpleSet Antenna (G1)	0.80 (20.4)	± 3.0

Wiring Diagram

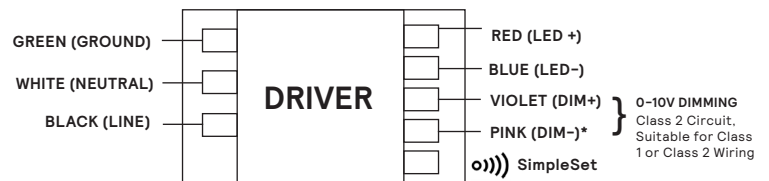

*DIM- will change from GREY to PINK from 2021 onwards.

Warning

- Install in accordance with national and local electrical codes.
- Use 18 AWG Solid Copper Wire Rated ≥ 90 °C.
- Strip Wire 3/8".
- For Class 2 Wiring, Use 20 AWG-16 AWG.

Grounding

- Driver case must be grounded.

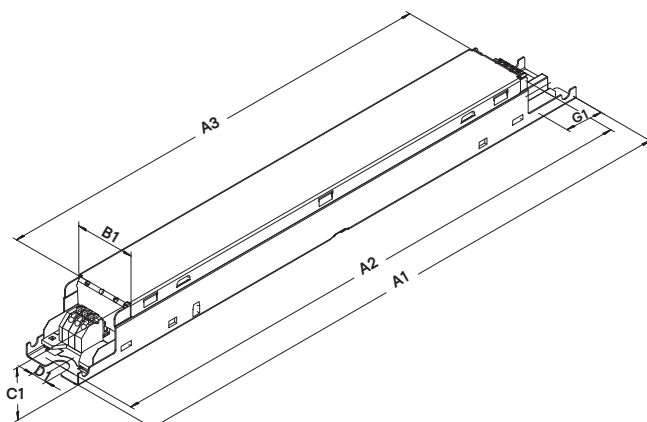

Xitanium XI020C056V054BST3

20W 0.1-0.56A 54V 0-10V INT (1% dim) with SimpleSet

Features

- 50,000+ hour lifetime¹
- SimpleSet programmable
- Large operating window
- 1% minimum dim level
- Constant Current Reduction (CCR) Dimming

Benefits

- Slim profile housing enables easy design-in with excellent thermal performance
- Enables simple, fast, flexible application-specific configurations
- Enables fixture designs with comprehensive application coverage for various loads and lumen levels

Application

- Indoor linear applications such as troffers and pendants
- Office
- Education
- Healthcare
- Retail
- Big box stores

Electrical Specifications

All the specifications are typical and at 25°C unless specified otherwise.

Product Data

Order Information	
Full Product Code	XI020C056V054BST3 (Mid-Pack, 18pcs/Box), 12NC:929002703813
Line Frequency	50/60Hz
Min. Mains Voltage Operational	108 Vac
Max. Mains Voltage Operational	305 Vac
Output Information	
Maximum Open Circuit Voltage	<=60Vdc (Class 2 output)
Output Current Ripple (ripple = peak to average / average)	15% max @ max Iout 4% max @ frequency range 60Hz-3KHz
Output Current Tolerance (in the performance window)	<5%
Flicker	Pst:≤0.5, SVM:≤1.0
Protections	Short Circuit and Open Circuit Protection for LED + and LED-, mis-wiring protection for 0-10V interface
Features	
0-10V Dimming	150µA source current from driver. See dim curve for detail.
AOC (Adjustable Output Current)	0.1A-0.56A via SimpleSet programming (refer to graph and notes below)
Additional SimpleSet Configurable Features	Adjustable minimum dimming level, Dimming curve selection (linear or logarithmic), Adjustable output level, Adjustable output min, OEM write protection
Environment & Approbation	
Operating Ambient Temp. Range	-20°C to +50°C
Max Case Temperature (Tcase)	75°C for Life / 80°C for UL
Agency Approbations	UL8750, CSA-C22.2 No. 250.13, NOM, Class P (ETL, cUL, UL)
Electromagnetic Compliance	FCC Title 47 Part 15 Class A
Audible Noise	<24dB Class A
Weight	0.44 Lbs / 0.2 kgs

1. Advance Xitanium LED drivers are manufactured to engineering standards correlating to a designed and average life expectancy of 50,000 hours of operation at maximum rated case temperature. Minimum 90% survivals based on MTBF modeling.

Xitanium XI020C056V054BST3

20W 0.1-0.56A 54V 0-10V INT (1% dim) with SimpleSet

Electrical Specifications

All the specifications are typical and at 25°C unless specified otherwise.

0-10V Dimming Curve

Dimming source current from the driver: 150µA (@ 0<Vdim<8V)

Minimum dim level: 1% of Iout (minimum 1mA)

Maximum output voltage on the dimming wires: 12V

Leakage current of dimming leads: 0.01 mA, recommended max number of control circuits in parallel refer to Design-in Guide.

Approved Dimmer List

Manufacturer	Manufacturer Part Number
Lutron	Visit www.lutron.com/advance for a list of dimmers (Mark VII) that will work with this driver
Leviton	IllumaTech IP7 series
Advance	Sunrise - SR1200ZTUNV

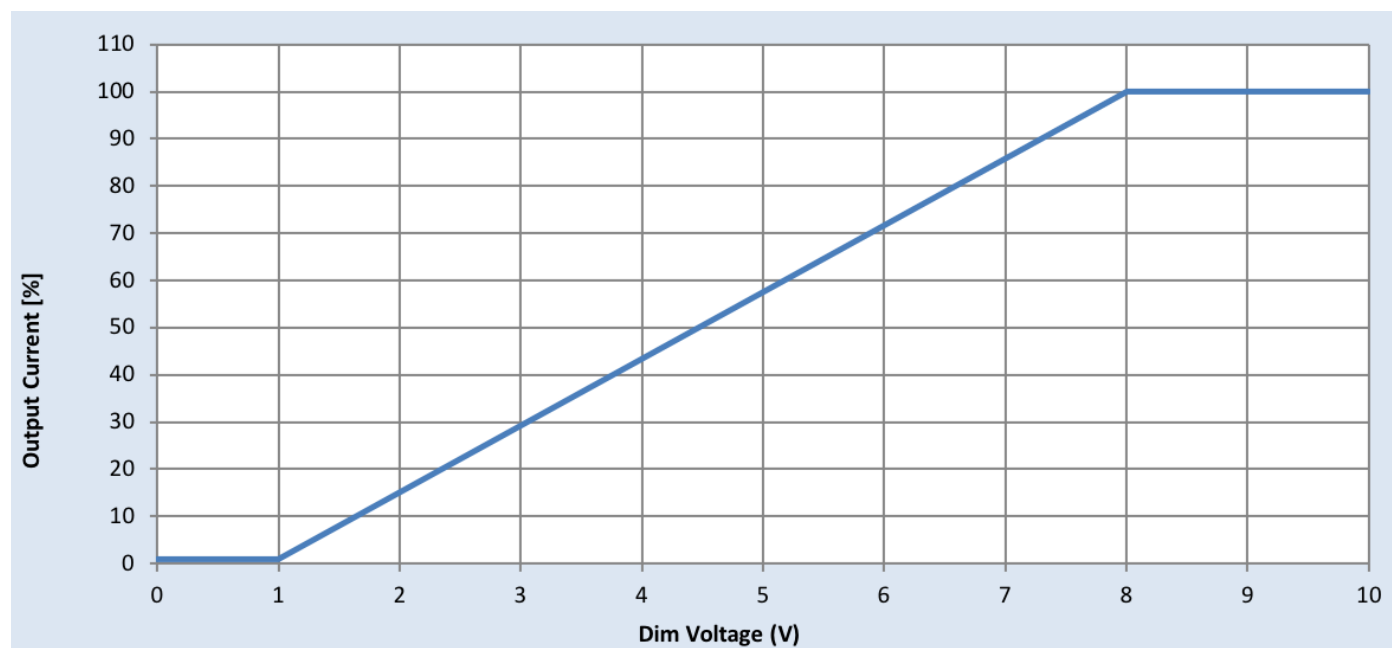

Xitanium XI020C056V054BST3

20W 0.1-0.56A 54V 0-10V INT (1% dim) with SimpleSet

Electrical Specifications

All the specifications are typical and at 25°C unless specified otherwise.

Driver Output Window

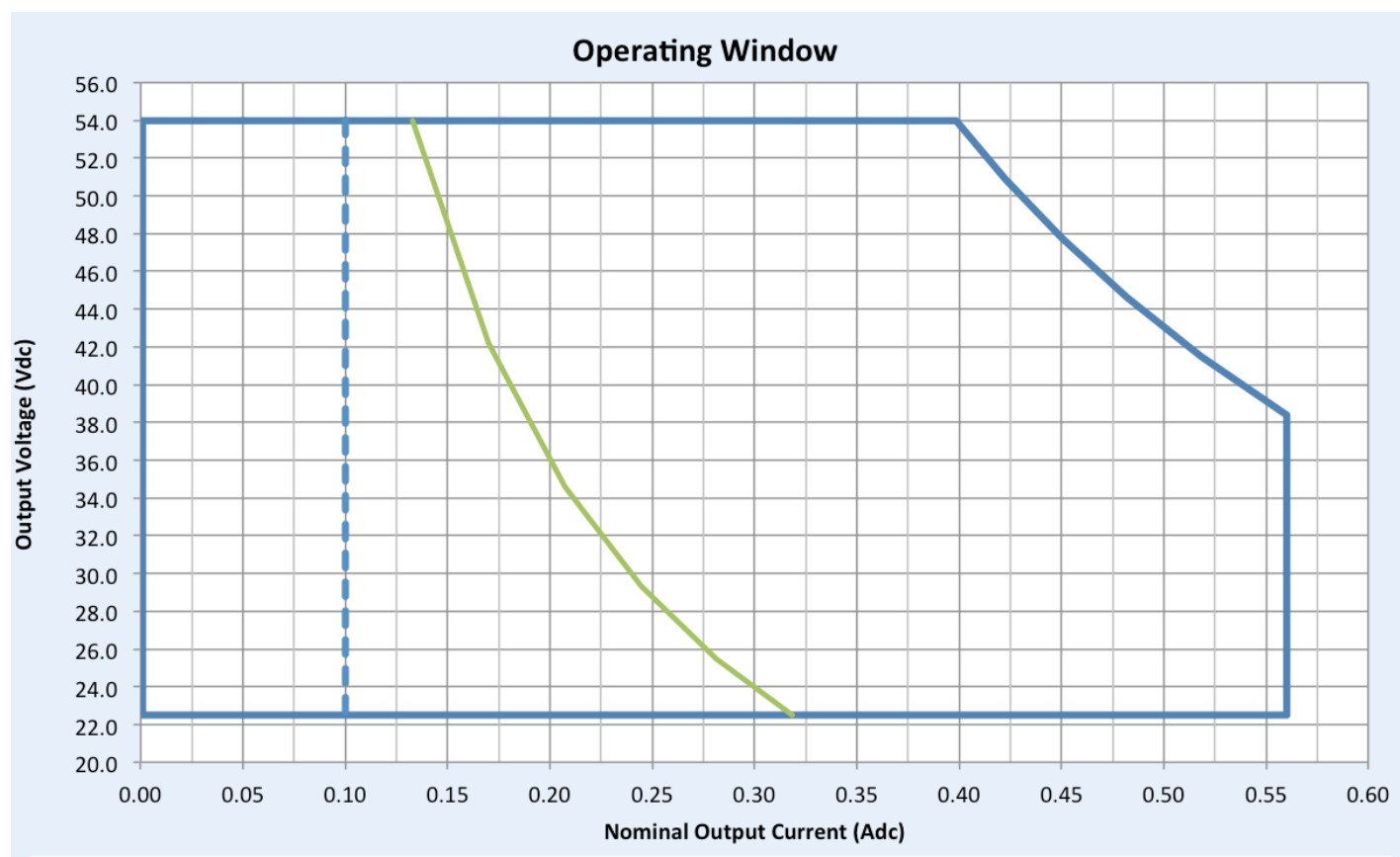

Notes

1. Factory default output current is 0.56A.
2. For dimming to a minimum level of 1% the output current setting through AOC should be $\geq 0.1A$.

Xitanium XI020C056V054BST3

20W 0.1-0.56A 54V 0-10V INT (1% dim) with SimpleSet

Electrical Specifications

All the specifications are typical and at 25°C unless specified otherwise.

Output Current Vs. Driver Case Temperature

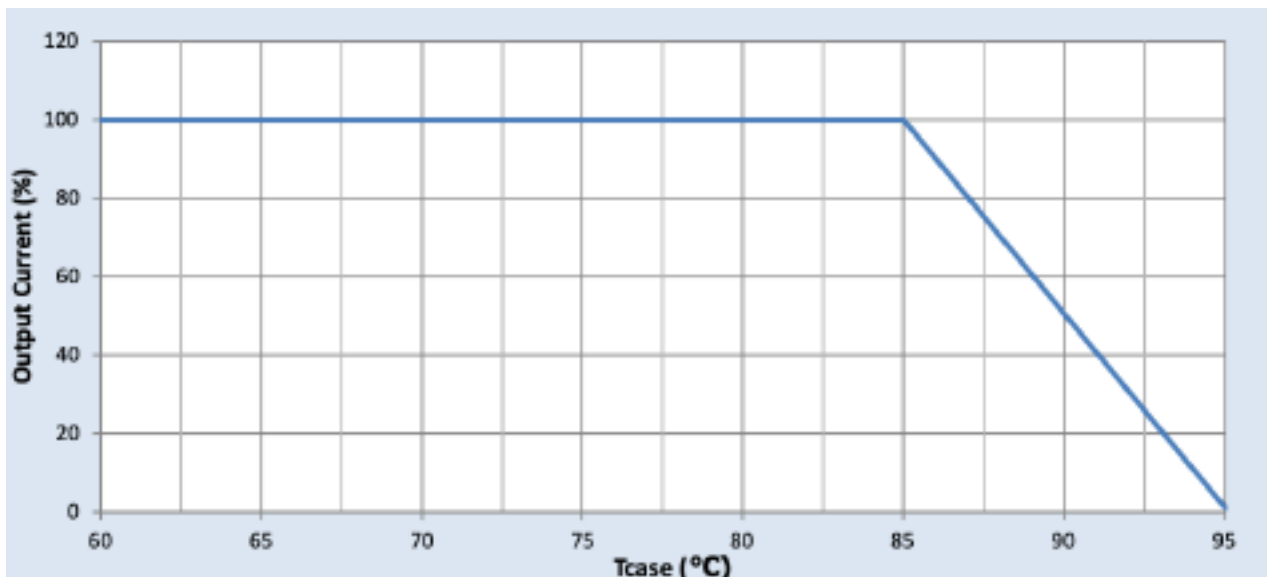

Note: There is $\pm 5^\circ\text{C}$ tolerance on the driver case temperature.

Driver Lifetime vs. Driver Case Temperature

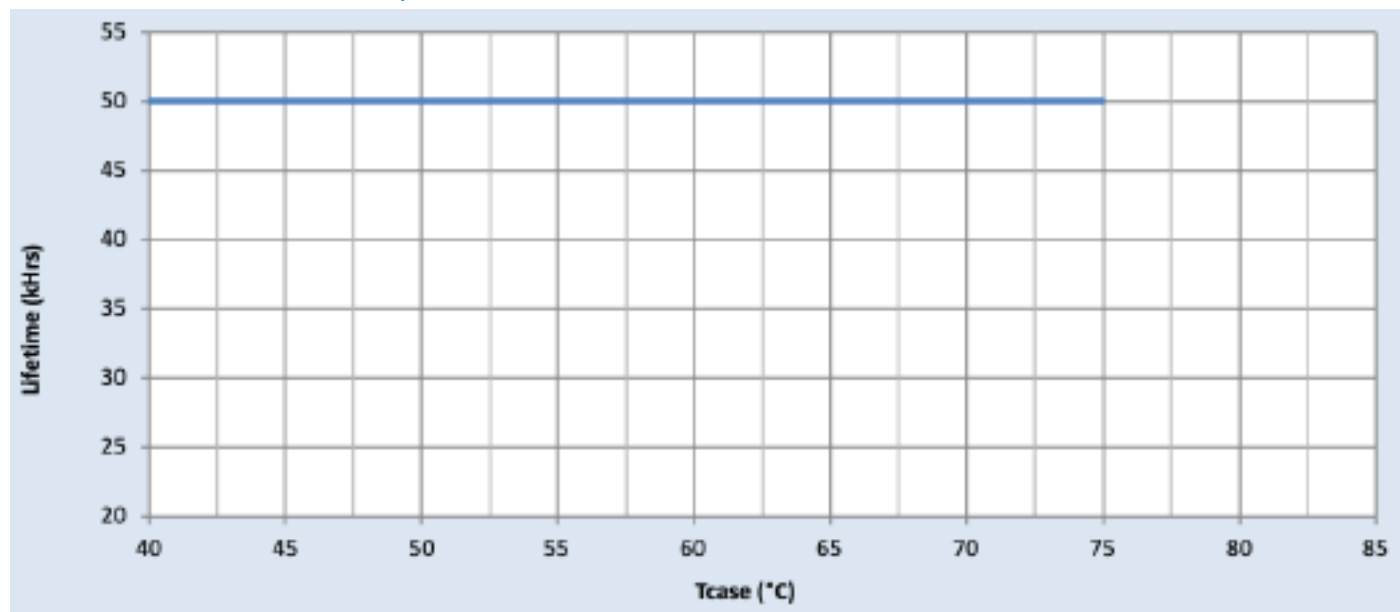

Xitanium XI020C056V054BST3

20W 0.1-0.56A 54V 0-10V INT (1% dim) with SimpleSet

Performance Characteristics

Based on measurements on a typical sample at 75°C case. The accuracy of the measurements is within the tolerance of the measurement instruments.

Efficiency Vs. Output Voltage at 120Vac

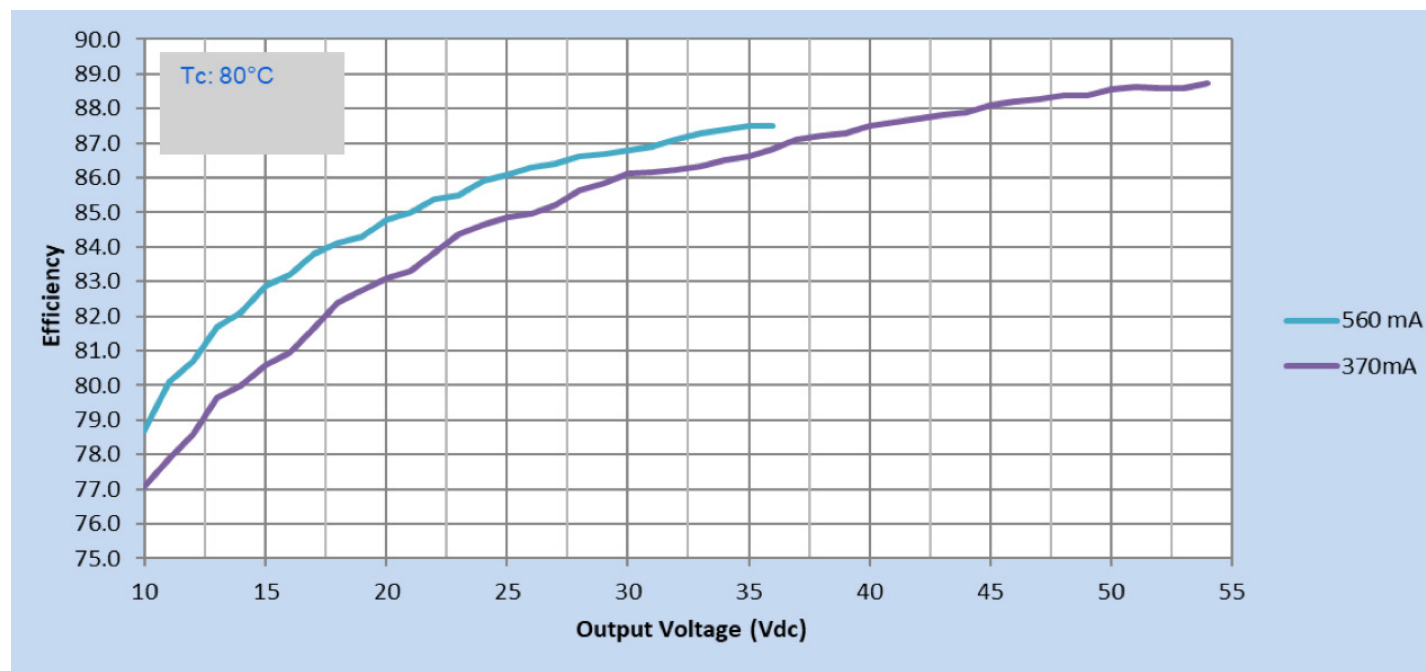

Efficiency Vs. Output Voltage at 277Vac

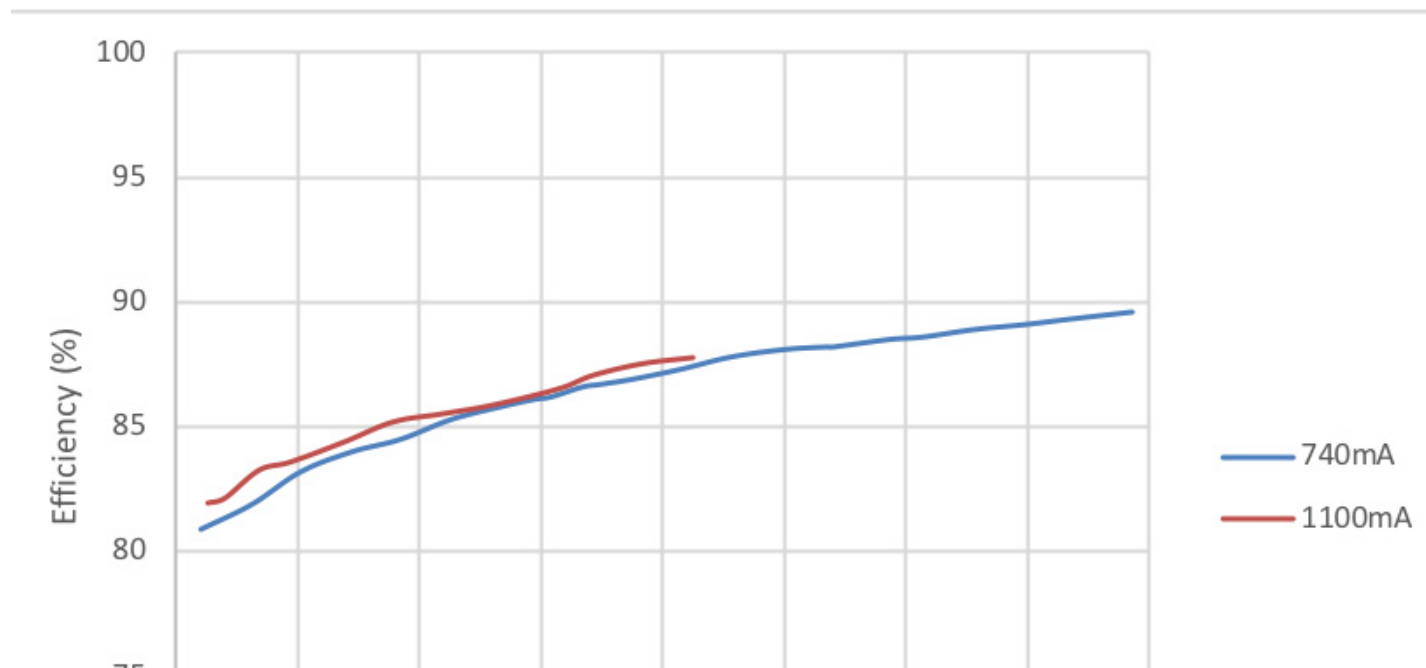

Xitanium XI020C056V054BST3

20W 0.1-0.56A 54V 0-10V INT (1% dim) with SimpleSet

Performance Characteristics

Based on measurements on a typical sample at 70°C case. The accuracy of the measurements is within the tolerance of the measurement instruments.

Power Factor Vs. Output Power

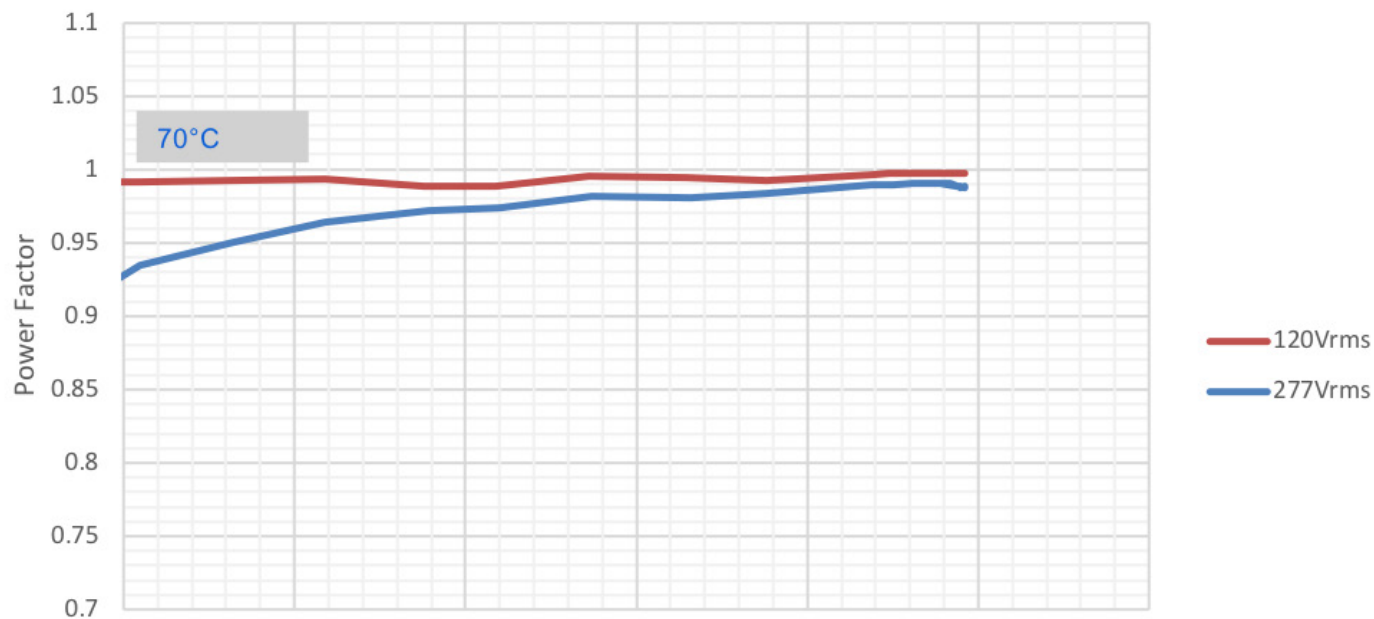

Total Harmonic Distortion (THD) Vs. Output Power

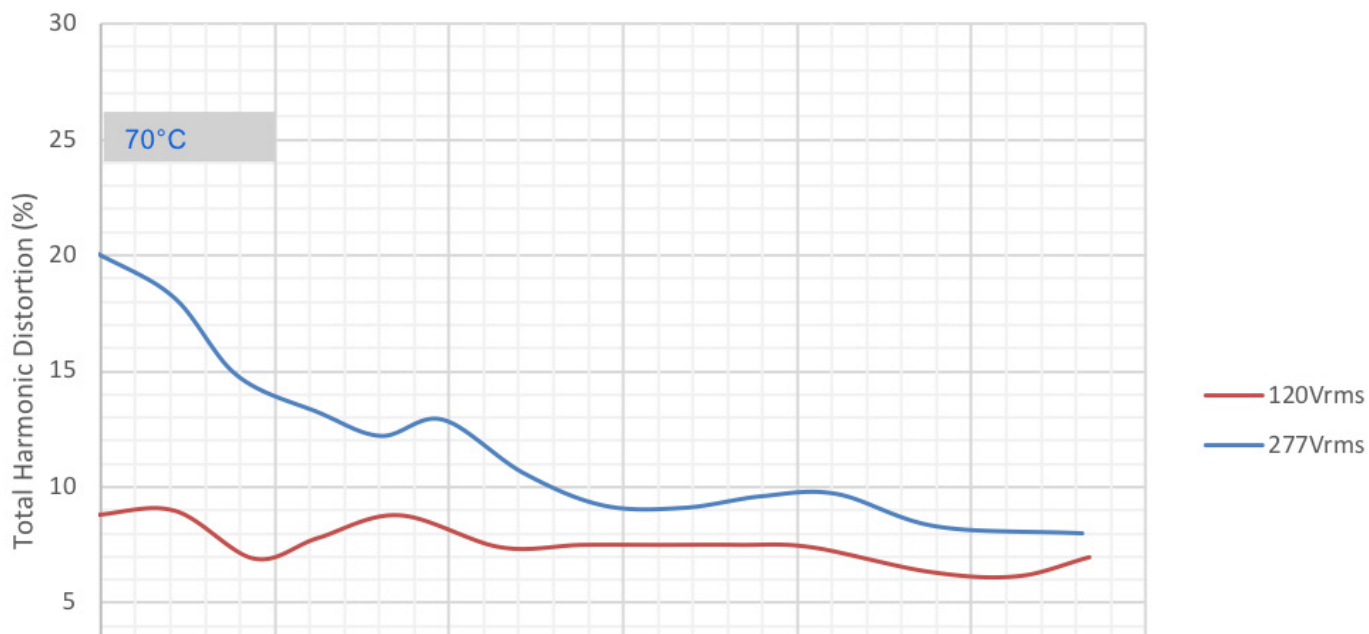

Xitanium XI020C056V054BST3

20W 0.1-0.56A 54V 0-10V INT (1% dim) with SimpleSet

Inrush Current Info

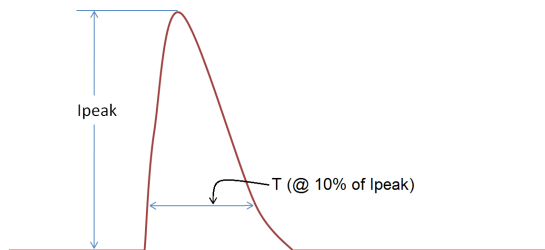

Vin	Ipeak	T (@ 10% of Ipeak)
120 Vrms	7.35A	5.59μS
277 Vrms	19.8A	4.76μS

Inrush current is measured at peak of the corresponding line voltage. Source impedance per NEMA 410.

Lightning Surge Info

ANSI Surge Type	Differential Mode (L-N)	Common Mode (L-G, N-G, L&N-G)
100kHz Ring Wave (w/t 30Ω)	>2.5KV	>2.5KV

Isolation

Isolation	Input	Output	0-10V	Enclosure
Input	-	2xU+1kV	2xU+1kV	2xU+1kV
Output	2xU+1kV	-	2xU+1kV	2xU+1kV
0-10V	2xU+1kV	2xU+1kV	-	2xU+1kV
Enclosure	2xU+1kV	2xU+1kV	2xU+1kV	-

U = Max input voltage



© 2021 Signify Holding. All rights reserved. The information provided herein is subject to change, without notice. Signify does not give any representation or warranty as to the accuracy or completeness of the information included herein and shall not be liable for any action in reliance thereon. The information presented in this document is not intended as any commercial offer and does not form part of any quotation or contract, unless otherwise agreed by Signify.

Signify North America Corporation
200 Franklin Square Drive,
Somerset, NJ 08873
Telephone 855-486-2216

Signify Canada Ltd.
281 Hillmount Road,
Markham, ON, Canada L6C 2S3
Telephone 800-668-9008

All trademarks are owned by Signify Holding or their respective owners.