



NVENT CADDY SLICK NUT, POLYAMIDE, SPRING STEEL, 1/2" HOLE, THREADED

CATALOG NUMBER

SLICK500



FEATURES

Provides fast universal attachment of threaded rod and hardware to standard strut profiles

PRODUCT ATTRIBUTES

Material: Polyamide;Spring Steel

Finish: nVent CADDY Armour

Hole Size: 1/2"

Hole Type: Threaded

Height: 11/16"

Torque: 10 ft lb

Static Load 1: 600 lb

Static Load 2: 100 lb

Static Load 3: 250 lb

ADDITIONAL PRODUCT DETAILS

Indicated loads are independent of the threaded stud or rod.

Indicated loads are applicable on 14 GA and 12 GA (2 mm and 2.5 mm) strut channels only.

DIAGRAMS

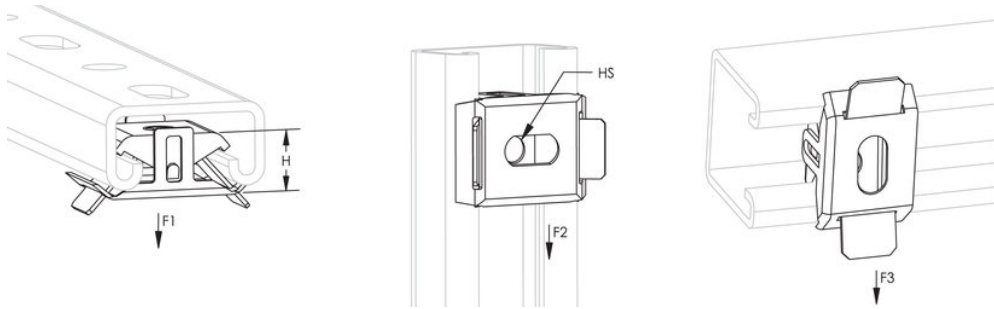

WARNING

nVent products shall be installed and used only as indicated in nVent's product instruction sheets and training materials. Instruction sheets are available at www.nvent.com and from your nVent customer service representative. Improper installation, misuse, misapplication or other failure to completely follow nVent's instructions and warnings may cause product malfunction, property damage, serious bodily injury and death and/or void your warranty.

North America

+1.800.753.9221

Option 1 – Customer Care

Option 2 – Technical Support

Europe

Netherlands:

+31 800-0200135

France:

+33 800 901 793

Europe

Germany:

800 1890272

Other Countries:

+31 13 5835404

APAC

Shanghai:

+ 86 21 2412 1618/19

Sydney:

+61 2 9751 8500



Our powerful portfolio of brands:

nVent.com CADDY ERICO HOFFMAN RAYCHEM SCHROFF TRACER

© 2022 nVent. All nVent marks and logos are owned or licensed by nVent Services GmbH or its affiliates. All other trademarks are the property of their respective owners.

nVent reserves the right to change specifications without notice.