



BOLT CLOSE CONDUIT/PIPE CLAMP, S304, 1/2" EMT, 1/2" RIGID/PIPE, 1/4" HOLE

CATALOG NUMBER

CD0BSS



CERTIFICATIONS

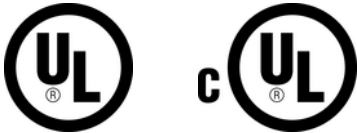

FEATURES

Retained bolt and built-in nut means there are less parts to handle or drop

Combo head bolt works with slotted, hex, #3 phillips or #2 robertson drivers

PRODUCT ATTRIBUTES

Material: Stainless Steel 304 (EN 1.4301)

Nut Type: Hex Nut

Outer Diameter: 0.670" – 0.840"

EMT Conduit Size: 1/2"

Rigid Conduit/Pipe Size: 1/2"

Hole Size: 1/4"

Static Load 1: 200 lb

DIAGRAMS

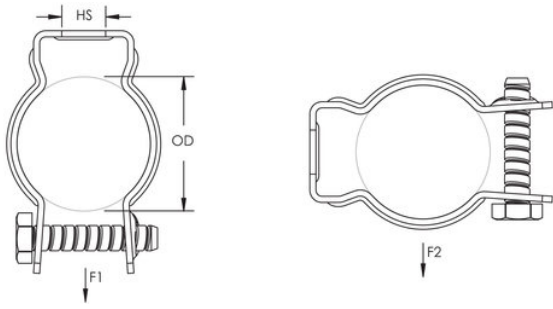

WARNING

nVent products shall be installed and used only as indicated in nVent's product instruction sheets and training materials. Instruction sheets are available at www.nvent.com and from your nVent customer service representative. Improper installation, misuse, misapplication or other failure to completely follow nVent's instructions and warnings may cause product malfunction, property damage, serious bodily injury and death and/or void your warranty.

North America

+1.800.753.9221

Option 1 – Customer Care

Option 2 – Technical Support

Europe

Netherlands:

+31 800-0200135

France:

+33 800 901 793

Europe

Germany:

800 1890272

Other Countries:

+31 13 5835404

APAC

Shanghai:

+ 86 21 2412 1618/19

Sydney:

+61 2 9751 8500



Our powerful portfolio of brands:

nVent.com CADDY ERICO HOFFMAN RAYCHEM SCHROFF TRACER