



## Easily bring power and charging right where you need it

RDZ, RDSZ, RDB, RDSB, RDZC, RDSZC, RDR

The world today runs on mobile devices. In fact, the average person carries more than 3 devices on them at once. Keeping these mobile devices charged is critical to both personal and professional success.

radiant Furniture Power Centers allow you to conveniently bring power and charging right to the spaces where people work and play, all in a compact, aesthetically pleasing package. Office lobbies, waiting rooms, cafeterias, restaurants/bars, lecture halls, transportation hubs, guest rooms, etc. can benefit from the installation of radiant Furniture Power.

### Features & Benefits

- **Meets Safety Standards.** Models either have 2, 3 or 4 tamper-resistant receptacles to keep little fingers away from danger.
- **Fast Device Charging.** Some models provide two USB charging ports (5V, 3.1A total) ensuring that all of your devices charge as quickly as possible.
- **Versatile.** Compact, low profile design allows you to mount the unit in more places than ever before.
- **UL Spill Water Compliant.** Passed UL 962A spill water test requirements so it can even be used in a horizontal surface such as a table top.
- **Beautiful.** Available in three attractive radiant finishes, black, white and nickel, so you can match or complement any furniture style. Included bezel hides the mounting screws for a cleaner look.
- **Easy to Install.** Mounts using screw clamps instead of wood screws, allowing you to mount the unit in more types of surfaces, even glass and stone. Installation is a snap: Cut the opening, insert the unit, tighten the clamps, snap on the bezel and plug it in.
- **Lighting control option.** RDSZ & RDSZC models have a push button switch that controls a rear outlet for connection and control of a sconce, table lamp or floor lamp. Switch is ADA compliant (Section 309.4 f, 2010 ADA Standards for Accessible Design).
- **Pass-thru plug.** The pass-thru plug on the radiant Furniture Power Center allows you to connect the power center to any outlet, even one that is already being used.
- **FCC Compliance.** This device complies with part 15 of the FCC Rules. Operation is subject to the following two conditions: (1) This device may not cause harmful interference, and (2) this device must accept any interference received, including interference that may cause undesired operation.
- **ETL Listed.** Listed to both US and Canadian safety standards. (RD4R not listed to Canadian safety standards.)

### Compliance

cETLus Meets UL962A the standard for Furniture Power Distribution Units and CSA C22.2 No. 308, the standard for Cord Reels and Multi-Outlet Assemblies. All models passed the Spill Test for UL962A and are suitable for installation on horizontal surfaces.

RD4R ETLus Listed.

## TECHNICAL SPECIFICATIONS

### 3rd Party Compliance

cETLus Listed to UL962A, the Standard for Furniture Power Distribution Units and  
CSA C22.2 No. 308, the standard for Cord Reels and Multi-Outlet Assemblies

### Performance

#### ELECTRICAL

Electrical	Outlets rated 15A, 125Vac
Cord Set	6' (1.83m) or 10' (3.05m), SJT 14/3 right angle 5-15P Pass-Thru Plug
USB	5Vdc, 3.1A Shared

#### MECHANICAL

Mounting	Mounts in vertical or horizontal position Any material up to 3/4" (19mm) thick
----------	---

#### ENVIRONMENTAL

Operating Temperature	0°C to 65°C (32°F to 149°F)
Storage Temperature	-35°C to 85°C (-31°F to 185°F)

### Warranty

One Year

**RDZ & RDZC**

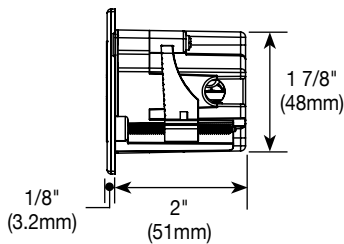
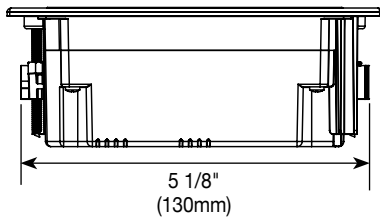
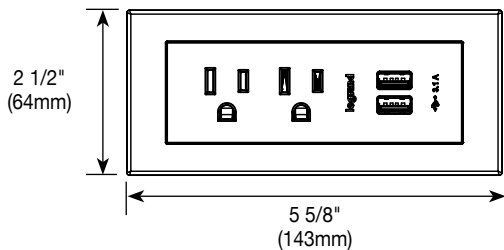

**RDSZ & RDSZC**

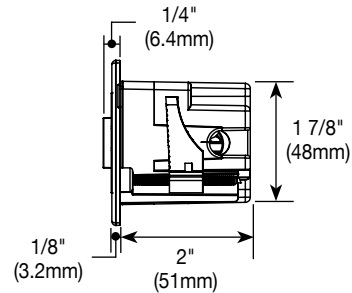
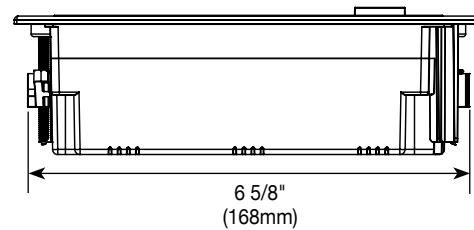
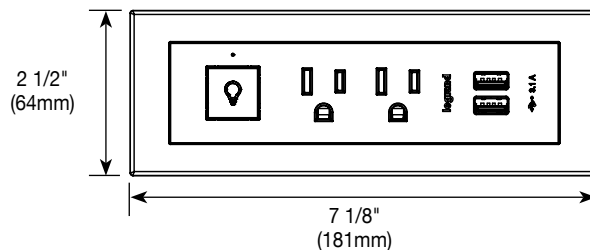

## Ordering Information

**RDZBK**  
**RDZWH**  
**RDZNI**

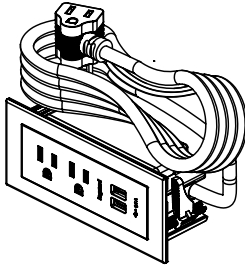

### Basic Power Unit (RDZxx) –

Two (2) tamper-resistant (TR) receptacles and two (2) fast charging USB ports. 6' (1.83m) cord with pass-thru plug. Receptacles rated 15A, 125Vac. USB ports rated 5Vdc, 3.1A total. Overall dimensions 5 5/8" wide by 2 1/2" tall by 2 1/8" deep (143mm x 64mm.x.54mm). Mounting flange is 1/8" (3.2mm) thick. Requires a hole cut of 5 1/4" wide by 2" high (133mm x 51mm). Available in black (RDZBK), white (RDZWH) and nickel (RDZNI).

**RDZBK10**  
**RDZNI10**  
**RDZWH10**

### Basic Power Unit with 10' Cord (RDZxx10) –

Same as Basic Power Unit with 10' (3.1m) cord with pass-thru plug. Available in black (RDZBK10), nickel (RDZNI10) and white (RDZWH10).

**RDSZBK**  
**RDSZWH**  
**RDSZNI**

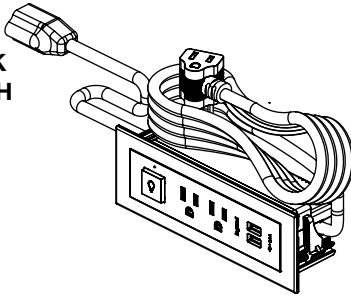

### Switching Power Unit (RDSZxx) –

Two (2) tamper-resistant (TR) receptacles and two (2) fast charging USB ports. 6' (1.83m) cord with pass-thru plug. Also has ADA-compliant push-button switch on the front that controls a rear receptacle to allow lighting control of a customer supplied portable lamp. Rear receptacle provided on the end of an 8" (203mm) cord. Receptacles rated 15A, 125Vac. USB ports rated 5Vdc, 3.1A total. Overall dimensions 7 1/8" wide by 2 1/2" tall by 2 1/8" deep (181mm x 64mm.x.54mm). Mounting flange is 1/8" (3.2mm) thick. Requires a hole cut of 6 5/8" wide by 2" high (168mm x 51mm). Available in black (RDSZBK), white (RDSZWH) and nickel (RDSZNI).

**RDSZBK10**  
**RDSZNI10**  
**RDSZWH10**

### Switching Power Unit with 10' Cord (RDZxx10) –

Same as Switching Unit but with 10' (3.1m) cord with pass-thru plug. Available in black (RDSZBK10), nickel (RDSZNI10) and white (RDSZWH10).

## Ordering Information

RDZCBK  
RDZCWH  
RDZCNI

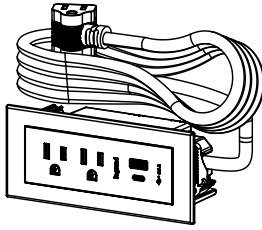

### Basic Power Unit (RDZCxx) –

Two (2) tamper-resistant (TR) receptacles and two (2) fast charging USB ports. One USB A port and one USB C port. 6' (1.83m) cord with pass-thru plug. Receptacles rated 15A, 125Vac. USB ports rated 5Vdc, 3.1A total. Overall dimensions 5 5/8" wide by 2 1/2" tall by 2 1/8" deep (143mm x 64mm.x.54mm). Mounting flange is 1/8" (3.2mm) thick. Requires a hole cut of 5 1/4" wide by 2" high (133mm x 51mm). Available in black (RDZCBK), white (RDZCWH) and nickel (RDZCNI).

RDZCBK10  
RDZCNI10  
RDZCWH10

### Basic Power Unit with 10' Cord (RDZCxx10) –

Same as Basic Power Unit with 10' (3.1m) cord with pass-thru plug. Available in black (RDZCBK10), nickel (RDZCNI10) and white (RDZCWH10).

RDSZCBK  
RDSZCWH  
RDSZCNI

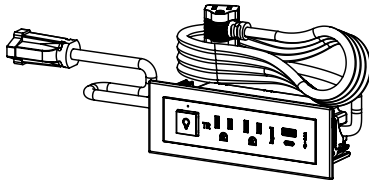

### Switching Power Unit (RDSZCxx) –

Two (2) tamper-resistant (TR) receptacles and two (2) fast charging USB ports, one USB A port and one USB C port. 6' (1.83m) cord with pass-thru plug. Also has ADA-compliant push-button switch on the front that controls a rear receptacle to allow lighting control of a customer supplied portable lamp. Rear receptacle provided on the end of an 8" (203mm) cord. Receptacles rated 15A, 125Vac. USB ports rated 5Vdc, 3.1A total. Overall dimensions 7 1/8" wide by 2 1/2" tall by 2 1/8" deep (181mm x 64mm x 54mm). Mounting flange is 1/8" (3.2mm) thick. Requires a hole cut of 6 5/8" wide by 2" high (168mm x 51mm). Available in black (RDSZCBK), white (RDSZCWH), and nickel (RDSZCNI).

RDSZCBK10  
RDSZCNI10  
RDSZCWH10

### Switching Power Unit with 10' Cord (RDSZCxx10) –

Same as Switching Unit but with 10' (3.1m) cord with pass-thru plug. Available in black (RDSZBK10), nickel (RDSZCNI10) and white (RDSZCWH10).

## TECHNICAL SPECIFICATIONS

**3rd Party Compliance**

cETLus Listed to UL962A, the Standard for Furniture Power Distribution Units and CSA C22.2 No. 308, the standard for Cord Reels and Multi-Outlet Assemblies

RD4R ETLus Listed

**Performance**
**ELECTRICAL**

Electrical Outlets rated 15A, 125Vac

Cord Set

6' (1.83m) or 10' (3.05m), SJT 14/3 right angle 5-15P Pass-Thru Plug (RD4R SJT 12/3)

**MECHANICAL**

Mounting

Mounts in vertical or horizontal position  
 Any material up to 3/4" (19mm) thick

**ENVIRONMENTAL**

Operating Temperature

0°C to 65°C (32°F to 149°F)

Storage Temperature

-35°C to 85°C (-31°F to 185°F)

**Warranty**

One Year

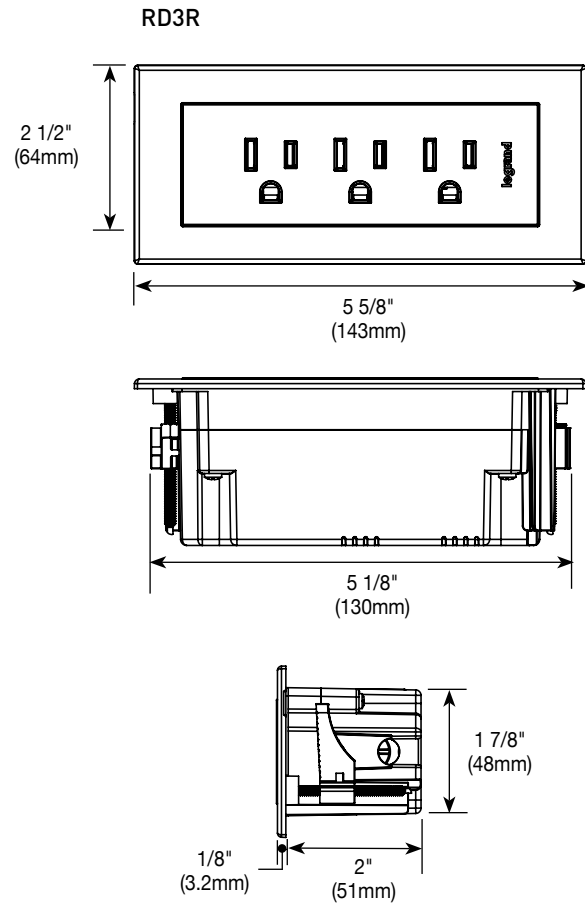
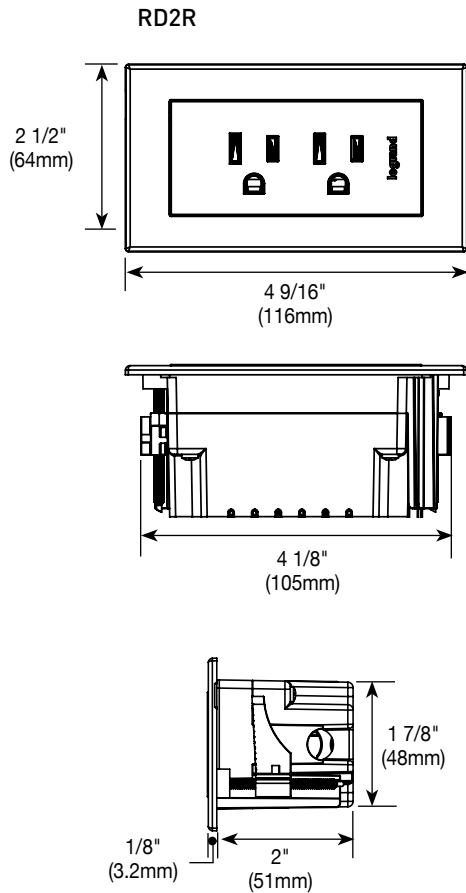

RD4R

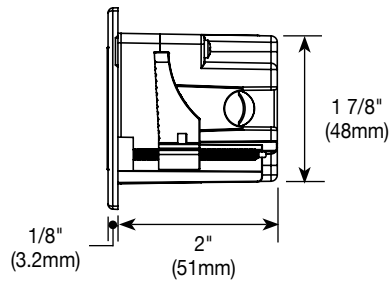
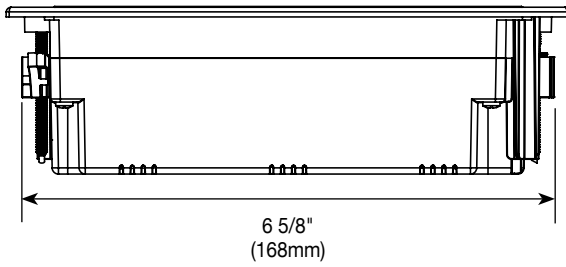
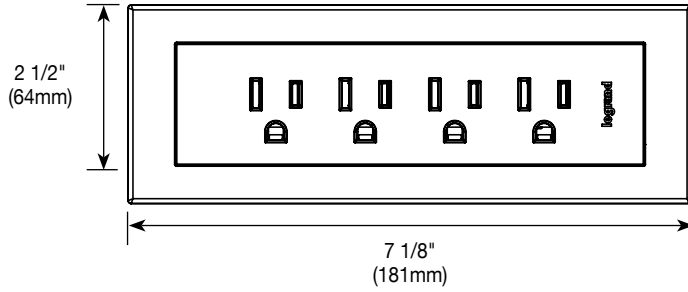

## Ordering Information

RD2RBK  
RD2RWH  
RD2RNI

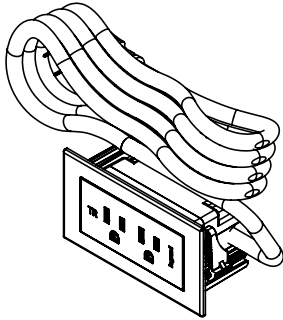

### Power Only Two Outlet Unit (RD2Rxx) –

Two (2) tamper-resistant (TR) receptacles. 6' (1.83m) cord with pass-thru plug. Receptacles rated 15A, 125Vac. Overall dimensions 4 9/16" wide by 2 1/2" tall by 2 1/8" deep (116mm x 64mm.x.54mm). Mounting flange is 1/8" (3.2mm) thick. Requires a hole cut of 5 1/4" wide by 2" high (133mm x 51mm). Available in black (RD2RBK), white (RD2RWH), and nickel (RD2RNI).

RD2RBK10  
RD2RWH10  
RD2RNI10

### Power Only Two Outlet Unit with 10' Power Cord (RD2Rxx10) –

Same as Power Only Unit but with 10' (3.1m) cord with pass-thru plug. Available in black (RD2RBK10), white (RD2RWH10) and nickel (RD2RNI10).

RD3RBK  
RD3RWH  
RD3RNI

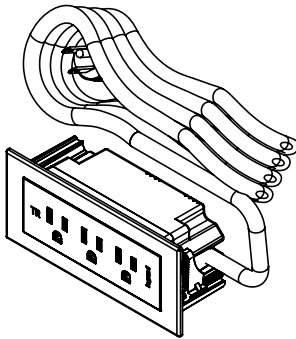

### Power Only Three Outlet Unit (RD3Rxx) –

Three (3) tamper-resistant (TR) receptacles. 6' (1.83m) cord with pass-thru plug. Receptacles rated 15A, 125Vac. Overall dimensions 5 3/4" wide by 2 1/2" tall by 2 1/8" deep (146mm x 64mm.x.54mm). Mounting flange is 1/8" (3.2mm) thick. Requires a hole cut of 5 1/4" wide by 2" high (133mm x 51mm). Available in black (RD3RBK), white (RD3RWH), and nickel (RD3RNI).

RD3RBK10  
RD3RWH10  
RD3RNI10

### Power Only Three Outlet Unit with 10' Power Cord (RD3Rxx10) –

Same as Basic Power Unit but with 10' (3.1m) cord with pass-thru plug. Available in black (RD3RBK10), white (RD3RWH10) and nickel (RD3RNI10).

RD4RBK  
RD4RWH  
RD4RNI

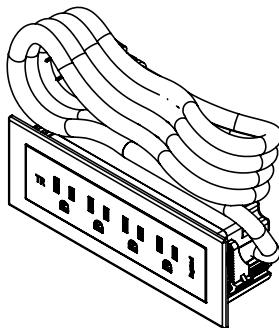

### Power Only Four Outlet Unit (RD4Rxx) –

Four (4) tamper-resistant (TR) receptacles. 6' (1.83m) cord with pass-thru plug. Receptacles rated 15A, 125Vac. Overall dimensions 7 1/8" wide by 2 1/2" tall by 2 1/8" deep (181mm x 64mm.x.54mm). Mounting flange is 1/8" (3.2mm) thick. Requires a hole cut of 5 1/4" wide by 2" high (133mm x 51mm). Available in black (RD4RBK), white (RD4RWH), and nickel (RD4RNI).

RD4RBK10  
RD4RWH10  
RD4RNI10

### Power Only Four Outlet Unit with 10' Power Cord (RD4Rxx10) –

Same as Basic Power Unit but with 10' (3.1m) cord with pass-thru plug. Available in black (RD4RBK10), white (RD4RWH10) and nickel (RD4RNI10).

## Ordering Information

RDB2BK  
RDB2WH  
RDB2NI

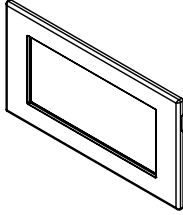

**Replacement Bezel for Power Only Two Outlet Unit (RDB2xx)** – Overall dimensions 4 9/16" wide by 2 1/2" tall by 1/8" thick (116mm x 64mm x 3.2mm). Available in black (RDB2BK), white (RDB2WH) and nickel (RDB2NI).

RDBBK  
RDBWH  
RDBNI

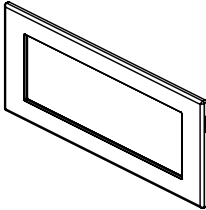

**Replacement Bezel for Basic Power Unit & Power Only Three Outlet Unit (RDBxx)** – Overall dimensions 5 5/8" wide by 2 1/2" tall by 1/8" thick (143mm x 64mm x 3.2mm). Available in black (RDBBK), white (RDBWH) and nickel (RDBNI).

RDSBBK  
RDSBWH  
RDSBNI

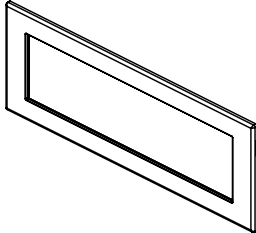

**Replacement Bezel for Switching Unit & Power Only Four Outlet Unit (RDSBxx)** – Overall dimensions 7 1/8" wide by 2 1/2" tall by 1/8" deep (181mm x 64mm x 3.2mm). Available in black (RDSBBK), white (RDSBWH) and nickel (RDSBNI).









## Complementary Devices & Accessories



### radiant® Collection

The radiant collection of switches, outlets and dimmers by Legrand puts that stylish finishing touch affordably within reach. Radiant gets rid of unsightly screws, delivering clean looks in a range of colors and metallic finishes.



### adore® Furniture Power Center

Providing power, USB charging and lighting control in your high end furniture has never been easier. Just install the appropriate adorne Furniture Power Center in your furniture and plug in your light fixture. Perfect for headboards, night stands, desks, side tables, etc. Models are available to switch any cord connected lighting load. There are also models that will dim cord connected incandescent, halogen, CFL/LED and ELV fixtures, up to 450W.



### adore® Collection

The adorne collection by Legrand combines the world's most innovative light switches and outlets with an array of stylish and custom finishes.



### deQuorum™ Flip-Up Table Boxes

deQuorum™ Flip-Up Table Boxes bring ready access to power and USB charging to work surfaces, desks, night stands and any other horizontal surface. Horizontal surfaces are prone to spills from liquids. Recognizing that accidents often happen, deQuorum Flip-Up Table Boxes have been designed and rated specifically to perform in these areas.

## Vertical Markets

- Retail
- Hospitality
- Commercial Office
- Municipal
- Multi-Dwelling Units
- Education
- Worship
- Transportation

**NOTE: All brand and product names referenced in this document are registered trademarks or trademarks of their respective holders.**



**NOTE:** The paper used to print this document is an environmentally responsible paper with 10% post consumer waste, with FSC and SFI Chain of Custody certifications, Lacey Act compliant. 100% of the electricity used to manufacture Flo sheets is generated with Green-e certified renewable energy.



**Legrand, North America**  
60 Woodlawn Street  
West Hartford, CT 06110  
1.877.BY.LEGRAND (295.3472)  
www.legrand.us

**Canada**  
905.738.9195  
www.legrand.ca

FOLLOW US

