

Get new dimensions under control.
Protecting with SIRIUS.



sirius

PROTECT

SIEMENS

3 7	Innovative, proven, and systematic: The SIRIUS system
8 9	More than switching and starting: SIRIUS protecting loads
10 19	Far more than ON-OFF: SIRIUS circuit-breakers
20 29	Thermal or solid-state: SIRIUS overload relays
30 33	Clear and comprehensive: The selection table
34 35	Alphabetical and definitive: The glossary



*It is impossible to comprehend
the energy when a supernova explodes.*

The universe is full of dimensions and possibilities we've never even

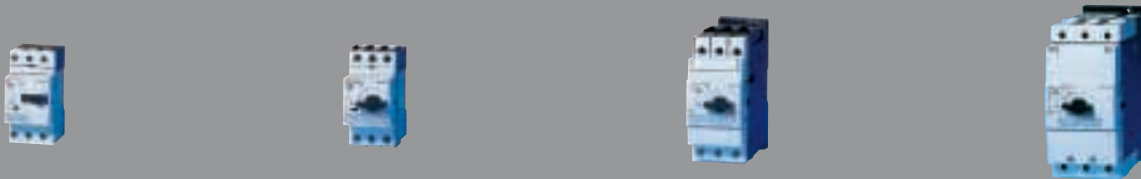

imagined. You'll find them right here on Earth, too. In order to be

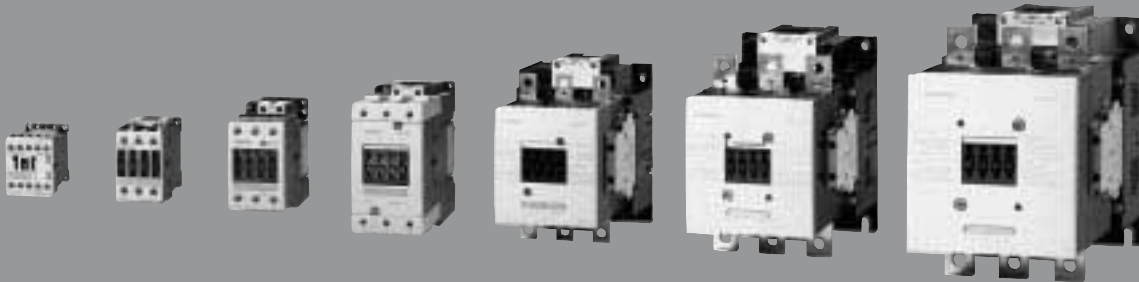

able to reliably and safely monitor these inconceivable dimensions



(short-circuit and overload), the SIRIUS system offers the optimum

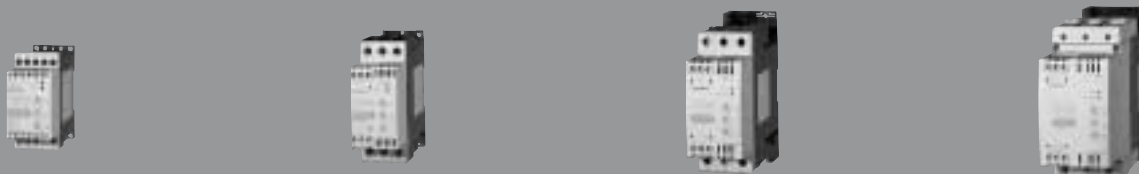

protective element for every requirement. That's a fact.

Spiral galaxies, like the M100 shown here in the stellar constellation Virgo, comprise cooler, older stars at the center, while young, hot stars colonize it a considerable distance away.





Our solar system is unique, flexible,
and stable.

Before we continue on the subject of protecting with SIRIUS, you should first get to know the SIRIUS system. Siemens, with SIRIUS, has created a modular system for switching, protecting, and starting loads. It comprises standard components, which are optimally harmonized with one another and which can be combined as required.

With the modular SIRIUS system, it is extremely easy to configure load feeders from modular standard components



The advantages of the SIRIUS system at a glance:	
Load feeders	Up to 250 kW/400 V (500 Hp/600 V) can be simply realized using standard devices
Modular design	Everything fits together and can be combined as required
Versions and sizes	Cost-effective and flexible using seven compact sizes
Assembly	Fast commissioning, short setup times, simple wiring
Communications	Open for SIRIUS NET; can be connected to AS-Interface and PROFIBUS-DP
Service	Extremely long service life, reliability and low maintenance
Design	Space-saving as a result of the low device width and side-by-side mounting up to 60°C
Approvals	Approved and certified world-wide with UL, CSA, marine and more
Optical design	Simple and ergonomic, it has received several awards
Mounting	Screwed or snapped on for reliable mounting over its service life
Service	Fast delivery of components and spare parts through a global logistics network
Environmental issues	Environmentally-compatible production and materials; can be recycled; low power loss
Accessories	Optimal variance with standard accessories
Cage Clamp	Fast, reliable connections, vibration-proof and maintenance-free

Just like the **SIRIUS** system ...

Get to know the SIRIUS system

The modular SIRIUS system is being continuously expanded and offers everything that is required to switch, protect and start motors and other loads. Modular, standard components, which fit together and can be easily combined, make working with SIRIUS so easy. Using SIRIUS, all of the requirements from the field can be individually fulfilled cost-effectively. The individual components distinguish themselves as a result of their space-saving design and high degree of flexibility. Engineering, installation and mounting, wiring, and service are extremely simple – saving a lot of valuable time. From the technical perspective, the SIRIUS system fulfills the highest standards and offers some unique highlights, for example, vacuum contactors and the remaining life-time signal for contactors. It doesn't make any difference whether a load feeder uses a circuit-breaker or overload relay, contactor or soft starter – SIRIUS always provides the optimum solution for every application.

Technical perfection: the SIRIUS design

It is quite obvious that people are enthusiastic about the technology of the modular SIRIUS system. However, a glance into a cabinet is also extremely appealing. Outstanding ergonomics, excellent optical design and finish ensure a transparent image – which is reflected in the fact that the SIRIUS series was awarded the iF Product Design Award.

Convincing flexibility: the combination possibilities

With SIRIUS, circuit-breakers, contactors, soft starters, and overload relays can be simply combined. The complete power range up to 250 kW/400 V (500 HP/600V) is covered by just six widths and seven sizes. Plug components together, tighten the screws, and the load feeder is ready. The ability to snap assemblies on to mounting rails also saves a lot of time.

With SIRIUS, you are never left alone: the global service network

It does not matter whether you are in Oslo, London or Capetown, world-wide, you can utilize the benefits of the unique modular SIRIUS system. SIRIUS has all of the relevant global approvals and is available everywhere. Siemens is at your service in 190 countries.

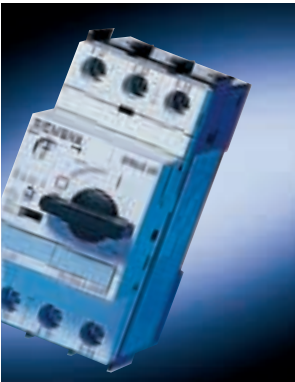
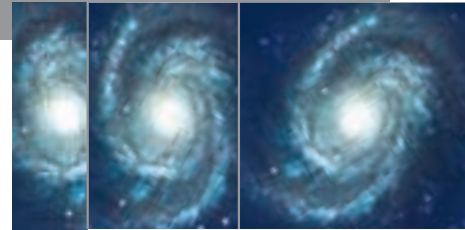

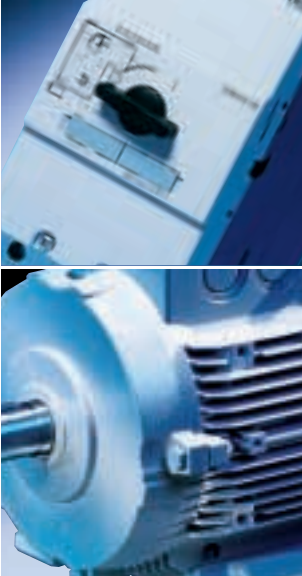

A simple question: why motor protection?

When a motor has failed, this generally means that not only could the unit itself be damaged, but the production process could also be disturbed, resulting in downtime. This is the reason that motor protection isn't just a pure technical issue – it also has a financial impact.

An electric motor converts electrical energy into mechanical energy. It draws energy from the line supply, converts this, and outputs mechanical energy at the shaft. This results in losses, which increase the motor temperature (copper losses in the stator and rotor of the motor, iron losses in the stator, and friction losses). A motor can be thermally overloaded for several reasons. Here are just a few: excessively high load torque in continuous operation, excessively high operating frequency, locked rotor, line supply imbalance, and phase failure. The main task of motor protection is to prevent high temperature jumps in the stator and rotor (overload) of the motor. The reason for this is that if the high temperature jump is permanent, this can result in damage and eventually cause a short-circuit. On the other hand, motor protective devices will not respond if the motor is running correctly.

A critical time: starting

It is also a critical time when a motor starts. The motor draws significantly more current when starting than when it is running under steady-state conditions. The starting current lies between 400 and 840 percent of the rated motor current, which is drawn under rated operating conditions. As a result of the high starting current, the stator, and rotor winding temperature assumes a high temperature within a few seconds because the heat doesn't have time to dissipate to the iron. This is the reason that when engineering a motor drive, the various starting times must also be taken into consideration.

Starting times of up to 10 seconds are considered to be normal (CLASS 10).

Longer starting times are considered to involve heavy-duty starting (CLASS 20 and CLASS 30).

Temperature- or current-dependent: the possibilities

There are two fundamental ways to protect motors: current-dependent and temperature-dependent methods. Current-dependent motor protection devices utilize the principle that the current in the motor increases with increasing temperature.

This means that these types of devices indirectly sense the temperature. Current-dependent motor protection devices include:

- Thermally-delayed overload releases as part of a circuit-breaker (refer to SIRIUS 3RV10).
- Thermally-delayed overload relays (refer to SIRIUS 3RU11)
- Solid-state overload relays (refer to SIRIUS 3RB10, 3RB12)

Temperature-dependent protective devices directly measure the temperature in the motor. The 3RN thermistor motor protection device and 3RS10 temperature monitoring relay are available for this purpose (refer to the SIMIREL brochure).



... which proves itself when
protecting motors

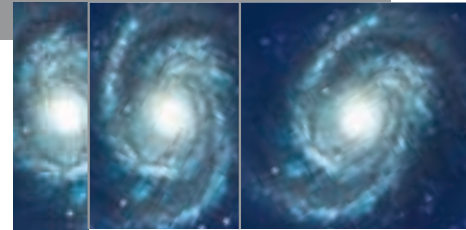

The advantages of the SIRIUS system are quite clear. There is no doubt about the necessity to have sensible motor protection. Now is the time to demonstrate just how the SIRIUS system takes into consideration the special requirements of motor protection.

*User-friendly overload protection:
In addition to the thermal overload
relay, the SIRIUS series also includes
the 3RB12 solid-state overload relay
for full motor protection.*



A supernova – like the 1987A here, which exploded in January 1987 – will still be able to be clearly seen many thousands of years later



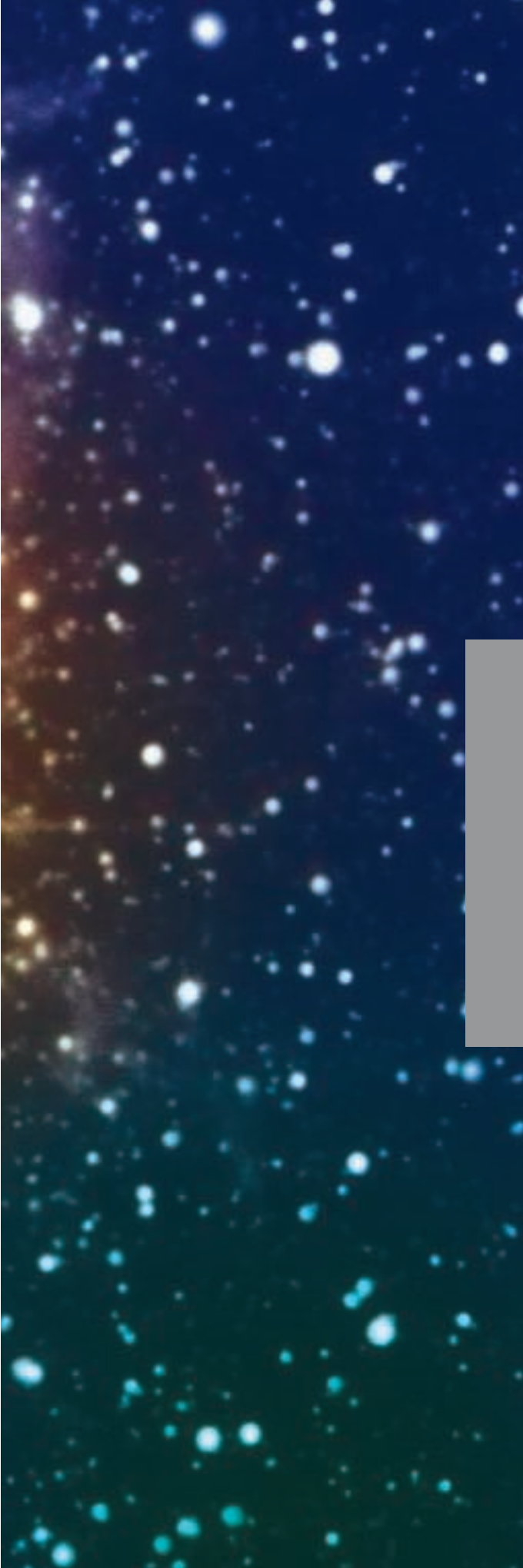

When a star explodes – a supernova – it is **100 million** times brighter than the sun.



A lot more than just ON-OFF: SIRIUS 3RV circuit-breakers*

SIRIUS 3RV circuit-breakers are compact, current-limiting circuit-breakers. They guarantee safe shutdown when short-circuits occur and protect loads and plants against overload. Furthermore, they are also suitable for operationally switching loads at a low operating frequency, as well as safely isolating the plant from the line supply when maintenance work or changes are required.

For every application: SIRIUS circuit-breakers are available in four sizes up to 100 A – to fulfill all requirements.

Structured and harmonized: technology and optical design

Just like all SIRIUS devices, the circuit-breakers are suitable for side-by-side mounting up to 60 °C. In addition to the usual CLOSED/OPEN circuit-breaker positions, the TRIPPED position is also indicated. SIRIUS circuit-breakers can be connected easily to the SIRIUS contactors and soft starters through a link module.

The clear, structured range is electrically, mechanically, and optically harmonized to the other families of SIRIUS devices – contactors, soft starters, and overload relays. Furthermore, the four frame sizes cover a current range up to 100 A. This corresponds to a power range up to 45 kW at 400 V AC (100 HP at 600 V).

Quickly assembled: fuseless load feeders

Fuseless load feeders can be easily assembled by combining a circuit-breaker with contactor, soft starter, and overload relay. We tell you all about the numerous combination possibilities and other details in the “Start” brochure.

Is it even possible: without fuses?

For the SIRIUS circuit-breakers, with their high short-circuit breaking capacity of at least 50 kA at 400 V AC, additional fuses are not required. In fact, there is a continuous series of circuit-breakers with 100 kA short-circuit breaking capacity for especially high requirements.

**The 3RV devices are referred to as circuit breakers in this document. However, for UL and CSA applications the 3RV is considered a Motor Starter Protector.*

Size
S00



Size
S0



Size
S2



Size
S3







Our **circuit-breakers** ensure it doesn't get quite so hot here on Earth.

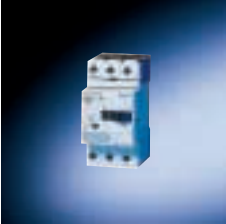

Of course, we know that current peaks with supernova dimensions are extremely rare here on Earth, but there are still some good reasons to have effective motor protection. If you place a lot of significance on high plant availability, and you want to protect your motors and plants, then you should get to know the SIRIUS circuit-breakers in more detail.

Overview of the sizes

Type	3RV1.1	3RV1.2	3RV1.3	3RV1.4
				
Size	S00	S0	S2	S3
Width	45 mm	45 mm	55 mm	70 mm
Max. rated current I_n max.	12 A	25 A	50 A	100 A
Features	Rocker operating mechanism, lockable in the zero position with a padlock	Rotary operating mechanism, lockable in the zero position with a padlock, optical TRIPPED indication (the lever is in the tripped position)	Rotary operating mechanism, lockable in the zero position with a padlock, optical TRIPPED indication (the lever is in the tripped position) CLASS 10 motor protection	Rotary operating mechanism, lockable in the zero position with a padlock, optical TRIPPED indication (the lever is in the tripped position) circuit-breakers for motor protection in CLASS 10 and CLASS 20. Either 50 or 100 kA short-circuit breaking capacity can be selected

The advantages of SIRIUS 3RV circuit-breakers at a glance:

Advantage	How you benefit
At 400 V AC, all setting ranges are short-circuit-proof up to 50 kA (in some cases, 100 kA)	Short-circuit calculations or series fuses can be omitted, as these values are seldom reached in practice
Standard accessories for all sizes	Minimizes stock inventory costs and the danger of accidentally interchanging accessories
All of the usual international Approvals (e.g. Type E certification for UL/CSA)	Standard engineering for different applications and various countries
Auxiliary contacts and auxiliary releases can be mounted without tools (simply click on... and it is ready!)	Reduces assembly time
Size S00 (up to 12 A), also with Cage Clamp connection including a wide range of accessories	Reduces wiring time Excellent immunity to vibration
Electrically and mechanically harmonized with SIRIUS contactors	The same width with the same rating, space-saving installation, and clear, transparent engineering.
Contactors and soft starters are simply mounted using link and wiring modules	Saves time and avoids wiring errors when mounting the devices

SIRIUS 3RV

A quick overview of the SIRIUS circuit-breakers: well-conceived, modular design that is attractive and functional and has received many awards.



Terminals

Generously dimensioned, they allow two conductors to be connected, even with different diameters.

Auxiliary contact at the front

This is standard across all sizes; when required, it can be simply plugged in; it affords a high degree of flexibility with low stock inventory.

Motor current setting

The complete setting range of the circuit-breaker can be used even when mounted side-by-side and for ambient temperatures up to +60°C.

Handling

Clear switching position indication, for rotary operating mechanisms, the TRIPPED position is also clearly indicated.

Circuit-breaker accessories

Auxiliary contacts

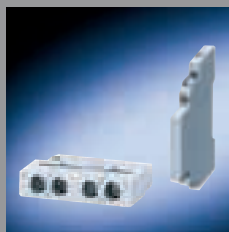

A comprehensive range of transversely- and laterally-mounted auxiliary contacts is available to signal the main contact position. Both of these versions can be snapped on without having to use tools and can be used for all sizes. Auxiliary contacts are also available with the Cage Clamp connection system. Transversely mounted auxiliary contacts are mounted at the front in a space-saving fashion.

Auxiliary releases

Undervoltage and shunt releases are available in almost all of the usual voltage versions encountered world-wide. They can be used for all sizes and are snapped onto the side of the device without having to use tools.



Three-phase busbar system

Several circuit-breakers can be supplied in parallel simply and quickly using three-phase busbars. The system is available for sizes S00, S0 and S2. Busbars for two to five circuit-breakers are available for distribution. A three-phase line-side terminal is used to connect the incoming supply voltage either from the top or from the bottom.

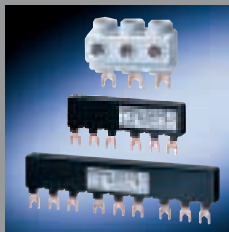

Door-coupling rotary operating mechanisms



Rotary operating mechanisms for mounting in cabinet doors are available with black as well as with red/yellow EMERGENCY OFF knobs. They have degree of protection IP65 and can be locked with up to three padlocks. The door-coupling rotary operating mechanisms comply with the requirements of IEC 60 947-2 regarding isolating characteristics under arduous conditions.



Enclosure and front plates

Matching molded-plastic enclosures are available for the circuit-breakers, sizes S00, S0 and S2. These enclosures are available in four widths for applications with and without laterally-mounted accessories. All of the enclosures have degree of protection IP55 and can also be supplied with an EMERGENCY OFF knob and a locking mechanism. The range of accessories also includes cast aluminum enclosures for wall mounting with degree of protection IP65 for more rugged conditions, as well as enclosures and front plates for flush mounting and installation in cabinet doors.

DETAIL

Some basic information

For which applications can circuit-breakers be used?

Motor protection



SIRIUS 3RV10 circuit-breakers for motor protection are optimally designed for protecting three-phase motors. The motor current can be set using a scale at the front. Once the current

has been set, the circuit-breaker provides optimum motor protection against overload thanks to the integrated thermal release. The magnetic short-circuit release is set in the factory to 13x the circuit-breaker rated current (the maximum setting current). If this value is exceeded, then the circuit-breaker reliably trips within just a few milliseconds to disconnect the load feeder or plant section involved.

These circuit-breakers have an integrated phase failure sensitivity function. When a phase fails, resulting in overcurrents in the other phases, the circuit-breaker reliably trips in plenty of time.

Circuit-breakers for motor protection are available in all four sizes – S00 to S3 – thus covering a current range from 0.11 to 100 A.

In addition to the standard devices with tripping class 10, there are also circuit-breakers for heavy-duty starting with tripping class 20. They are available in sizes S2 and S3 (from 11A), and the thermal overload release used can handle a high inrush current under heavy-duty starting conditions over a longer period of time without tripping.

Motor protection

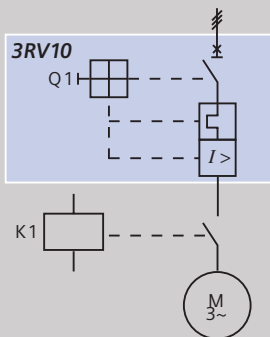

Motor protection with automatic RESET

SIRIUS 3RV11 circuit-breakers are also optimally dimensioned for protecting three-phase motors. They also have an automatic RESET feature when overload occurs using the integrated overload relay function.

The circuit-breaker with overload relay function remains closed when an overload condition develops, unlike circuit-breakers for motor protection. The overload release has two auxiliary contacts (1 NO + 1 NC), similar to an overload relay. These auxiliary contacts can be used to signal an overload condition to a higher-level control system or can directly trip a downstream contactor. The overload signal is automatically reset after the circuit-breaker has cooled down.

The advantages of this circuit-breaker are quite obvious

Thanks to the automatic RESET function, a technician does not have to go to the electrical cabinet and manually re-close the circuit-breaker after an overload condition. This saves time and also increases the productivity of the plant. When a short-circuit occurs, the circuit-breaker automatically trips and must be manually re-closed. The magnetic short-circuit release, just like the motor protection circuit-breaker, is set to 13x rated current. Just like the circuit-breaker for motor protection, it also has an integrated phase failure sensitivity function. The circuit-breaker with overload relay is available in sizes S0 to S3, covering a current range from 0.11 to 100 A.

Motor protection with automatic RESET

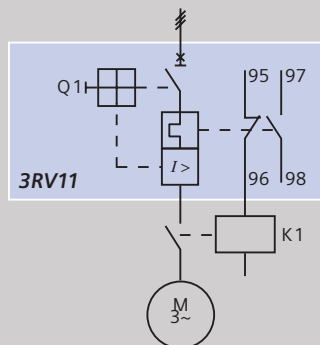

Plant protection

SIRIUS 3RV10 motor protection circuit-breakers are admirably suited for protecting plants and parts of plants.

Plant protection circuit-breaker

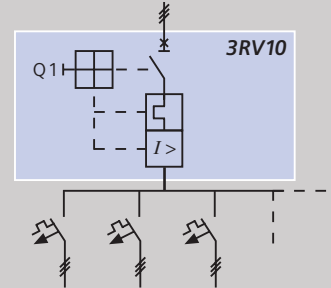

Starter combinations

Starter combinations, which comprise a contactor or soft starter and an overload relay, are used to operationally switch and provide overload protection for a motor. Short-circuit protection must also be provided. The SIRIUS 3RV13 circuit-breaker is in this case the obvious choice.

It has the same magnetic short-circuit release as the circuit-breaker for motor protection (which is set to 13x the rated current), but it does not have an overload release. The current range from 1.16 to 100 A can be covered using sizes S0 to S3.

Circuit-breaker for starter combinations

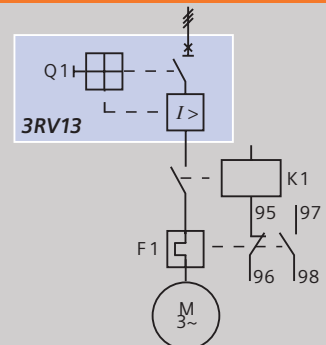

Technology in detail: the **circuit-breaker**

Transformer protection

When transformers are connected to the line supply, extremely high inrush currents can flow for a short time. These can cause the protective elements to trip unnecessarily. In order to protect transformers on the primary side, for these applications we recommend the circuit-breaker for transformer protection – the SIRIUS 3RV14. The magnetic short-circuit release for these devices is set in the factory to 20x the rated current. This means that the circuit-breaker does not unnecessarily trip when the transformer is connected to the line supply. The thermal overload release for this circuit-breaker is identical to that of the motor protection circuit-breaker. Motor protection circuit-breakers can also be used for transformers with lower inrush current. Circuit-breakers for transformer protection are available in sizes S0 and S2 - for a current range from 0.11 to 40 A.

Circuit-breaker for transformer protection

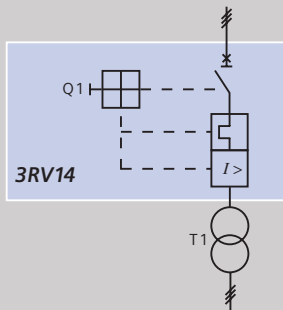

Fuse monitoring

The 3RV16 11-0BD10 SIRIUS circuit-breaker, size S00, can be used for fuse monitoring. Each fuse is connected in parallel to a current path of the circuit-breaker. When a fuse fails, the current flows through the current path of the circuit-breaker, which is connected in parallel, and trips it. The circuit-breaker is normally tripped by the magnetic release. For currents less than 1.2A, the circuit-breaker is tripped by the thermal overload release. The circuit-breaker can be supplemented by an auxiliary contact located either transversely or laterally. This auxiliary contact signals fuse failure or disconnects all phases of the faulted circuit through an appropriate switching device.

Circuit-breaker for fuse monitoring

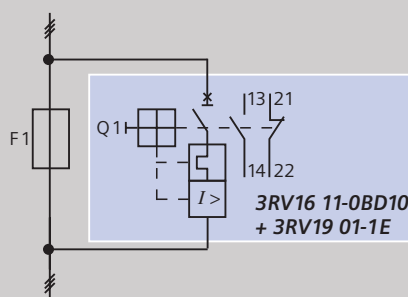

DETAIL

Some detailed information

How are the circuit-breakers connected?

All of the circuit-breakers, sizes S00 to S3 are available with screw connections. The complete range of circuit-breakers is designed so that two conductors can be connected for each phase, even if the conductors have different cross sections. The connection spaces allow adequately large conductor cross sections to be connected. All of the devices are supplied with captive screws.



Is there an alternative connection system?



The innovative Cage Clamp connection system is available for circuit-breakers size S00. In this case, two conductors can be connected per phase to two independent cage clamps. This has the advantage that the two conductors can be inserted and withdrawn independently of one another.

The Cage Clamp system is the fastest and most straightforward connection system but also offers a high degree of security and immunity against mechanical shock and vibration. Obviously, there are no screws to be re-tightened when the Cage Clamp system is used.

How are the circuit-breakers mounted?

All of the circuit-breakers in all sizes can be simply snapped onto the appropriate mounting rail. Insulated three-phase busbars for two to five circuit-breakers, sizes S00, S0 and S2, are available to connect them in parallel on the incoming side.

The system can be expanded as required to a maximum current load of 63A (S00 and S0) and 108A (S2) by using several busbars. The 3-phase line-side terminals are used to feed such a system. The use of a supply system saves time and avoids wiring errors. An even more user-friendly method is to plug the circuit-breakers directly



onto a busbar system using an adapter. Busbar adapters, both for 40 mm and 60 mm systems are available for all circuit-breaker sizes. This is, without doubt, the fastest mounting method – circuit-breakers are snapped onto the adapter, connected up, snapped onto the system and that's it. Furthermore, a system such as this means that individual circuit-breakers can be replaced quickly and easily.

How can a circuit-breaker be upgraded to create an enclosed motor starter?



Using a matching enclosure, the circuit-breaker for motor protection can be quickly and simply transformed into an enclosed motor starter. Motor starters such as these are used wherever motors must be manually and locally switched and protected. The range of applications of the encapsulated SIRIUS 3RV motor starter is almost unlimited – whether for drills, circular saws or industrial sewing machines. Molded-plastic enclosures are available for sizes S00, S0 and S2. If the motor starter is to be used under rugged conditions, then we recommend our cast aluminum housing, size S0. In addition to wall-mounting enclosures, there are also enclosures for flush mounting, in sizes S00 and S0, as well as front panels in sizes S00 to S3. Furthermore, all of the enclosure types can also be equipped with an EMERGENCY OFF switch or a locking device.



What are the important advantages of the enclosed SIRIUS motor starter?

- Available up to 50 A (22 kW at 400 V AC)
- Can be flexibly used as EMERGENCY OFF or repair switch
- Large metric cable glands, M25, M32 and M40
- Can be sealed to protect against manipulation and tampering
- N and PE terminals are already integrated
- Standard mounting dimensions (can be universally used, even replacing devices from other manufacturers)

A compact and high performance circuit-breaker: SENTRON VL

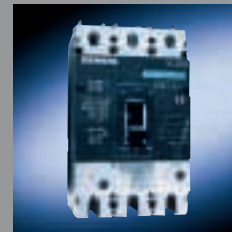

SENTRON VL circuit-breakers are available for applications with currents exceeding 100 A. SENTRON VL circuit-breakers distinguish themselves due to their compact and space-saving design. They are available in 3- and 4-pole versions, in six sizes for rated currents extending from 16 A to 1600 A, and for rated voltages up to 690 V. The short-circuit breaking capacity, depending on the make-break capacity, is either 40 kA, 70 kA or 100 kA, at 415 V AC. These circuit-breakers are available as non-withdrawable and withdrawable types. You can select from circuit-breakers for plant protection, motor protection, starter combinations, and load interrupter switches, depending on the particular application. Accessories for the SENTRON circuit-breakers can be used across the complete range.

Technology in detail: the **circuit-breaker**

What sizes are available and what are their characteristics? A total of four sizes cover the range up to 100 A. Precise data is available from the following table:

Technical data				
Type	3RV1.1	3RV1.2	3RV1.3	3RV1.4
Size	S00	S0	S2	S3
Number of poles	3			
Width	45 mm	45 mm	55 mm	70 mm
Max. rated current I_n max.	12 A	25 A	50 A	100 A
Lowest setting range	0.11...0,16 A	0.11...0,16 A	11...16 A	11...16 A
Highest setting range	9...12 A	20...25 A	40...50 A	80...100 A
Permissible ambient temperature: Storage/transport Operation Interior cabinet temperature Permissible rated current	-55 °C to +80 °C -20 °C to +70 °C (above 60 °C, current derating) +60 °C +70 °C 100% 87%			
Rated operational voltage V_E	690 V			
Rated frequency	50/60 Hz			
Rated insulation voltage voltage V_i	690 V			
Rated impulse withstand voltage voltage V_{imp}	6 kV			
Utilization category IEC 947-2 (circuit-breakers) IEC 947-4-1 (motor starters)	A AC-3			
Tripping CLASS IEC 947-4-1	10	10	10 or 20	10 or 20
Rated short-circuit breaking capacity I_{cu} at 400 V AC	100 kA (to $I_n = 6,3$ A) 50 kA (to $I_n = 12$ A)	100 kA (to $I_n = 12,5$ A) 50 kA (to $I_n = 25$ A)	50 kA	Either 50 or 100 kA
Shock resistance acc. to IEC 68 Part 2.27	25 g			
Degree of protection	IP 20	IP 20	IP 20 Connecting space IP 00	IP 20 Connecting space IP 00
Shock hazard protection acc. to DIN VDE 0160 Part 100	Safe against finger touch			
Temperature compensation acc. to IEC 947-4-1	-20 °C to +60 °C			
Phase failure sensitivity acc. to IEC 947-4-1	yes			
ATEX certification acc. to EC Directive 94/9/EC	yes			
Isolator characteristics acc. to IEC 947-3	yes			
Main and EMERGENCY OFF switch characteristics acc. to DIN VDE 0113	yes			
Safe separation between the main and auxiliary circuits acc. to DIN VDE 0106 Part 101	to 400 V			
Mech. endurance operating cycles	100,000	100,000	50,000	50,000
Electrical endurance operating cycles	100,000	100,000	25,000	25,000
Max. operating frequency per hour (motor starts)	15			
Permissible mounting position	Any, acc. to DIN 43602, Start command, at the right or at the top	Any	Any	Any



*It is easy to see the main star SIRIUS
in the Canis Major constellation
because it is so bright.*

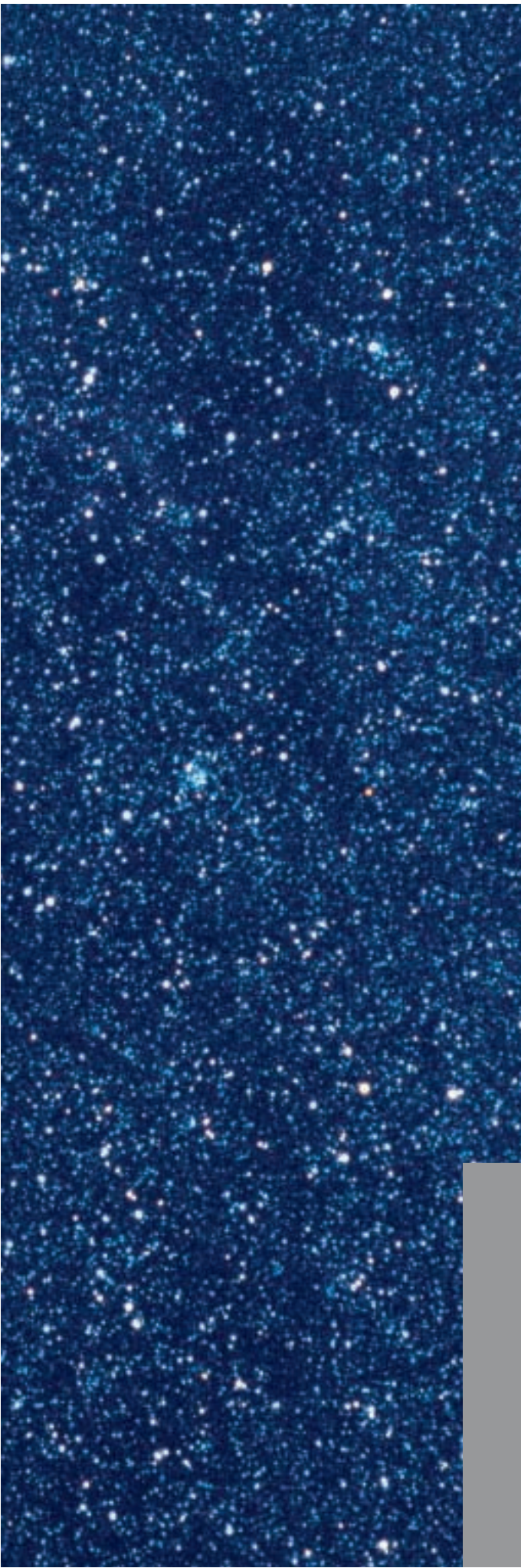

The small star at the top left registers **660,000 °C** on the thermometer.



*User-friendliness built-in:
Easy-to-read status displays, operator-friendly motor current and starting class setting, as well as color-coded TEST, STOP and RESET switches, take into account the requirements from the field.*

Size S00

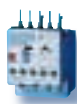

Size S0



Size S2



Size S3



Size S6



However, we are of the opinion that it doesn't have to get quite as hot.

This is the reason that the tripping points of our thermal and solid-state

overload relays are a lot lower.

Tripping when things get serious: SIRIUS overload relays

SIRIUS overload relays are available in a thermal version and also in a solid-state version for higher requirements. They have the function of providing current-dependent overload protection for loads (e.g. motors) in the main circuit as well as in the other switching and protective devices in the load feeder.

SIRIUS overload relays can be used to configure compact load feeders quite simply and in a space-saving fashion. This is because the overload relays are optimally harmonized to the other components (contactors, soft starters, etc.) of the modular SIRIUS system – electrically, mechanically, and optically.

The modular SIRIUS system also includes standard accessories, which are used independent of the size, and which match the 3RU11 thermal overload relay and the 3RB10 solid-state overload relay. This significantly simplifies engineering and minimizes stock inventory costs.

Higher requirements: Protect with 3RB12

Our 3RB12 solid-state overload relays offer an even higher degree of functionality and protection for full motor protection: these devices additionally protect your loads as a function of the temperature by using a PTC thermistor sensor circuit that is connected to the device. The PTC sensor measures the temperature directly in the motor windings, and the signals are evaluated by a relay. As a result of this integrated evaluation unit, it is often not necessary to use an additional temperature evaluation device (e.g. thermistor motor protection device or temperature monitoring relay). This also means that no special wiring is required. Furthermore, the 3RB12 relay allows the plant or system to be protected against the consequences of a ground fault using its internal and external ground fault sensing.

The 3RB12 also outputs an analog signal indicating the measured motor current.

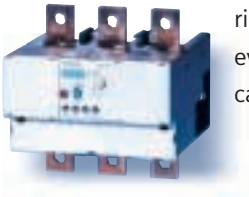

The 3UF50 SIMOCODE-DP motor protection and control device is the right selection if you require, in addition to the features of the 3RB12, even more comprehensive control functions, user-friendly diagnostic capabilities, and high performance communications via PROFIBUS-DP.

Size
S10/S12

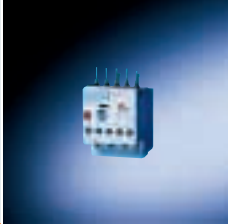
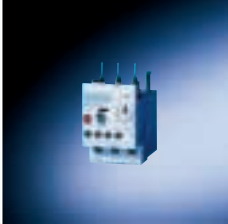

Our **overload relays** don't let your loads get too hot.

Overview of the versions of the 3RU11 and 3RB10 overload relays

Type	3RB1016	3RB1026	3RB1036	3RB1046
				
Size	S00	S0	S2	S3
Width	45 mm	45 mm	55 mm	70 mm
3RU11 thermal overload relay				
Main Order No.	3RU1116	3RU1126	3RU1136	3RU1146
Max. rated current	12 A	25 A	50 A	100 A
Lowest setting range	0.11...0.16 A	1.8...2.5 A	5.5...8 A	18...25 A
Highest setting range	9...12 A	20...25 A	40...50 A	80...100 A
Tripping Class	CLASS 10			
3RB10 electronic overload relay				
Main Order No.	3RB1016	3RB1026	3RB1036	3RB1046
Max. rated current	12 A	25 A	50 A	100 A
Lowest setting range	0.1...0.4 A	0.1...0.4 A	6...25 A	13...50 A
Highest setting range	3...12 A	6...25 A	13...50 A	25...100 A
Tripping Class	CLASS 10 and CLASS 20			

Overview of the versions of the 3RB12 electronic overload relays

Main Order No.	3RB1246	3RB1253	3RB1257	3RB1262
Max. rated current	100 A	205 A	500 A	820 A
Lowest setting range	0.25...6.3 A	50...205 A	125...500 A	200...820 A
Highest setting range	25...100 A	50...205 A	125...500 A	200...820 A
Tripping Class	CLASS 5, 10, 15, 20, 25 and 30 can be set			
Versions				
Standard version	A PTC thermistor sensor circuit and an additional summation CT can be connected with two outputs (each with 1 NO + 1 NC), which, depending on the version, can be used to trip and signal an overload, thermistor, ground fault trip, and/or an overload condition (overload alarm).			
Version with internal ground fault detection	Same as the standard version, but with an additional internal ground fault detection to sense fault currents			
Version with bi-stable output relay	Same as the standard version, but with a bi-stable output relay.			
Version with analog output	Same as the standard version, but with an additional analog output signal 4...20 mA for the motor current referred to the set motor current; to drive measuring instruments, processing in process control systems, communication via bus systems, to display overload and motor current.			

Technology in detail: the **overload relays**

3RB1056	3RB1066
	
S6	S10/S12
120 mm	145 mm
–	–
–	–
–	–
–	–
3RB1056	3RB1066
200 A	630 A
50...200 A	55...250 A
50...200 A	300...630 A

Some basic information

What are the overload relay functions?

Overload relays provide current-dependent overload protection against inadmissibly high temperature rises as a result of overload, phase imbalance, or phase failure. Under overload conditions, phase imbalance, or phase failure, the motor current increases beyond the selected rated motor current.

This increased current, if it flows for a longer period of time, can cause damage or even destroy the load. The overload relay senses the current and evaluates it. Two fundamental principles of operation are available: thermal and solid-state.

What is the difference between a thermal and solid-state overload relay?

With the 3RU11 thermal overload relay, the increased current heats up the bimetallic strips inside the device using heating elements. These bimetallic strips then actuate the auxiliary contacts through a release mechanism.

With the 3RB10 and 3RB12 solid-state overload relays, the increased current is sensed using the CT integrated in the devices and is evaluated using the appropriate electronics. This then outputs a pulse to the auxiliary contacts.

The contactor, and therefore the load, is shut down through the auxiliary contacts. The time it takes to disconnect the load depends on the ratio between the release current and the set current, which is saved in the form of a release characteristic that is extremely stable over a long period of time.

What happens when an overload relay responds?

The “tripped” condition is signaled using the switch position indication (3RU11 and 3RB10) or LED (3RB12). It can also be transferred using auxiliary contacts.

The device is reset either manually (directly at the device or remotely) or automatically after a recovery time has expired. The load can cool down during this recovery time.

Can load feeders be configured together with contactors and soft starters?

The overload relays are optimally harmonized to the 3RT contactors and the 3RW soft starters (also refer to the “Switch” brochure). This means that in addition to being separately mounted (in some cases using the individual mounting block), the overload relays can also be directly mounted on the device (3RB1246 is the exception) to form load feeders (refer to the “Start” brochure). This reduces the amount of space required.

DETAIL

How are overload relays connected?

The main and auxiliary current paths can be connected in multiple ways. In some cases, Cage Clamp connections can be used or use the straight-through transformer technique. After the overload relay has been connected, it can be checked for correct operation using a TEST function. In addition to the TEST function, the overload relays also have a STOP function.

How is short-circuit protection implemented?

An overload relay protects a load, as a function of the current, against overload, phase imbalance, and phase failure. Short-circuit protection must be implemented using fuses (fused) or circuit-breakers (fuseless).

Fused load feeder

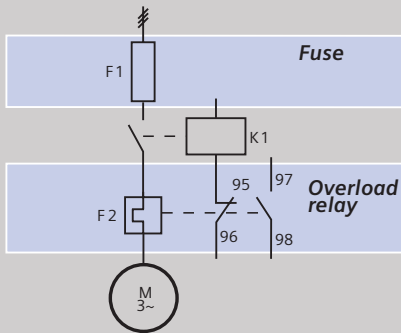

Fuseless load feeder with circuit-breaker for starter combinations

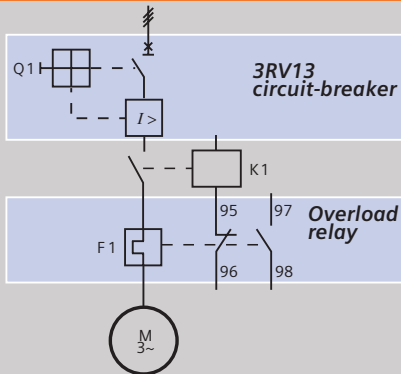

Can overload relays be used world-wide?

Overload relays are environmentally compatible and are not sensitive to external effects (e.g. aggressive environments and high temperatures). They are also certified in compliance with ATEX, which makes them suitable for motors with "increased safety" EEx e type of protection. They fulfill all of the important standards and approvals world-wide.

What accessories are available for the overload relays?

The range of accessories (single mounting block, electrical and mechanical RESET, terminal cover, etc.), for the overload relays covers all of the requirements with just a few versions.

Some detailed information

When is a thermal overload relay the correct choice?

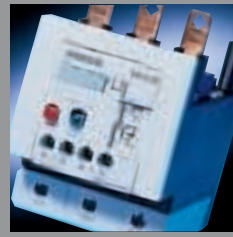

3RU11 thermal overload relays from 0.11 A to 100 A are available with tripping class 10 and offer a high degree of current-dependent protection for loads

with normal starting characteristics – and at a low price. The good price-performance ratio results in cost-effective protection, especially in the lower power range.

Why are solid-state overload relays especially suitable for more stringent requirements?

The 3RB10 and 3RB12 solid-state overload relays have some essential advantages over thermal overload relays. The common features of solid-state overload relays include wide setting ranges, low power loss, tripping classes which are higher than class 10 and an extremely precise release characteristic that is extremely stable over a long period of time:

- The wide setting ranges reduce the number of versions, minimize engineering time and costs, and reduce both the stock inventory with associated costs and the amount of capital that is tied up.

- The low power loss reduces the energy usage (the energy usage is up to 95 percent less than for thermal overload relays) and therefore the energy cost, minimizes the temperature increase of the contactor and interior of the cabinet (it may be possible to reduce or eliminate cabinet cooling). Furthermore, it can save space, as it can be directly mounted on the contactor, even for high motor currents (i.e. it does not have to be thermally insulated).

- Tripping classes higher than class 10 permit solutions for heavy-duty starting.

- The precision tripping characteristics, which are extremely stable over a long period of time, guarantee safe and reliable load protection even after years of use under difficult conditions.

What are the distinguishing features of the 3RB10 solid-state overload relay?

The 3RB10 solid-state overload relays, from 0.1 A to 630 A with their own supply, are available in tripping classes 10 and 20. With these two tripping classes, they offer optimum current-dependent load protection for normal and heavy-duty starting. When it comes to the dimensions, handling, and features, the 3RB10 solid-state overload relays correspond to the 3RU11 thermal overload relays. This means that thermal overload relays can be easily replaced by solid-state versions if more stringent demands apply for the overload protection – e.g. faster tripping within three seconds when a phase fails, wide setting ranges, and a reduced power loss therefore minimizing energy usage. The range of accessories is identical for the thermal and solid-state devices.

What are the distinguishing features of 3RB12 solid-state overload relays?

3RB12 solid-state overload relays, from 0.25 A to 820 A, with external supply, are suitable for light- and heavy-duty starting as a result of the variable and selectable tripping classes – class 5 to class 30. Using a rotary switch, the tripping classes can be varied in five steps. This reduces the number of versions, minimizes engineering time and costs, and reduces stock inventory and the associated costs and the amount of capital that is tied up.

Technology in detail: the **overload relays**

Advantages of overload relays at a glance

Features	Benefits
Trip on overload, phase asymmetry, phase imbalance, overheating (3RB12) and ground fault (3RB12)	Guarantees optimum load protection against inadmissibly high temperature rises
Short-circuit protection in conjunction with the appropriate fuses or the appropriate circuit-breaker	Permits optimum protection for the load and operating personnel when short-circuits occur resulting from insulation faults or incorrect switching operations
RESET function	Allows the relay to be either manually or automatically reset
TEST function	Permits the function and wiring to be simply checked
Status display	Signals the actual operating status
Large current setting knob	Makes it easier to precisely set the relay to the correct current value
Integrated auxiliary contacts (1NC + 1NO)	Allows the load to be shut down when an irregularity occurs, and permits the output of the appropriate signals
Electrically and mechanically harmonized to 3RT1 contactors	Simplifies engineering, reduces connection times and costs, and allows, in addition to individual mounting, space-saving direct mounting.
Temperature sensitivity/compensation	Allows the relay to be used even at high temperatures without derating, avoids premature trips, facilitates a compact electrical cabinet design without intermediate clearances between the devices/load feeders, simplifies engineering, and allows space to be saved in the cabinet
Highly durable	Guarantees safe, reliable load protection even after years of operation under difficult conditions
Wide setting ranges for the electronic devices	Reduces the number of versions, minimizes engineering times and costs, and reduces stock inventory and the associated costs and the amount of capital that is tied up
Tripping classes > class 10 for the solid-state devices	Permits solutions for heavy-duty starting
Reduced power loss of the electronic devices	Reduces the energy usage and therefore the energy costs, minimizes the temperature rise of the contactor and electrical cabinet, and reduces the amount of space required, as it can be directly mounted on the contactor, even for high motor currents
Standard accessories for all SIRIUS overload relays	Minimizes engineering time and costs and reduces stock inventory and the associated costs and the amount of capital that is tied up.
Device versions with Cage Clamp connection	Allows vibration and shock-resistant connections, eliminates service/maintenance work, and minimizes wiring time.

Beyond the selectable tripping classes, the 3RB12 solid-state overload relay offers numerous additional features and protective functions over the thermal 3RB10 overload relay: overload alarm, thermistor motor protection function, ground fault detection, self-monitoring, status displays using LEDs, analog output, as well as monostable and bi-stable auxiliary contacts.

Some specific information

What happens when an overload alarm is tripped? What are the advantages of this function?

After a limit current has been exceeded as a result of overload, phase imbalance, or phase failure, the 3RB12 relay flags a pending trip using a flashing LED. This alarm can also be transferred. This overload alarm allows counter-measures to be taken in plenty of time (e.g. loads can be shed) for load currents which exceed the limit current for a longer period of time. It also eliminates an additional device, minimizes the space required in the electrical cabinet, and reduces the wiring time and costs.

What is the thermistor motor protection function used for?

In addition to protecting loads against an inadmissibly high temperature rise, as a function of the current, the 3RB12 solid-state overload relay allows the motor winding temperature to be monitored. This is realized by connecting a PTC thermistor sensor circuit. Loads can be protected against overtemperature, for example, indirectly caused by a restricted cooling medium flow and which cannot be sensed by measuring the current. When an overtemperature condition develops, the 3RB12 de-energizes the contactor through the auxiliary contact and in turn disconnects the load. The sensor circuit connection is fail-safe, i.e. the device trips if the terminal is opened or a conductor is interrupted. This integrated thermistor motor protection function frequently eliminates having to use an additional separate device (refer to the 3RN thermistor motor protection devices and 3RS temperature monitoring relays), saves space in the electrical cabinet, and reduces the wiring time and costs.

Just what is ground fault detection?

In order to protect loads against ground faults as a result of insulation damage, moisture, condensation water, etc., 3RB12 overload relays can monitor ground faults in two ways:

1. Internal ground fault sensing (this is not possible for star-delta combinations) for motors with a 3-conductor connection to detect fault currents ≥ 30 percent of the setting current I_e at the rated operating point.
2. External ground fault sensing by connecting a summation CT for motors with 3- and 4-conductor connection to detect sinusoidal fault currents (50/60 Hz) of 0.3 A, 0.5 A and 1A.

When a ground fault occurs, the device trips, de-energizes the contactor through the auxiliary contacts, and disconnects the load. The "tripped" condition is signaled using a red LED (ground fault) and can also be signaled using a separate output. The internal or external ground fault detection means that an additional separate device does not have to be used. This saves space in the electrical cabinet and reduces the wiring time and costs.

What are the tasks of the self-monitoring function?

The 3RB12 relay continually checks that it is functioning correctly (self-monitoring function), and when an internal fault occurs, trips. In this particular case, there is no way of resetting the relay.

What information do the LEDs provide about the overload relay?

The LEDs are used as status display. They indicate when the device is functioning perfectly and the cause of a trip. After an overload, phase asymmetry, phase failure, thermistor trip, or ground fault, the device can be reset either manually or automatically after the recovery time has expired.

What can the optional analog output be used for?

The 3RB12 overload relay is also available with an analog output. With this device, the motor current, measured by a microprocessor, is converted into an analog output signal (4 mA up to 20 mA DC). This analog signal can be used to drive moving-coil instruments with a 4mA to 20 mA input or the analog inputs of PLC controls. Furthermore, the current values can be transferred, using an AS-Interface analog module via the AS-i bus system. The analog output eliminates an additional transducer and signal converter. In so doing, it reduces the space required in the electrical cabinet and reduces wiring costs.

In addition to mono-stable, are bi-stable auxiliary contacts also available?

Yes. The overload relays are generally equipped with mono-stable auxiliary contacts. As an alternative, two device versions can be ordered with bi-stable auxiliary contacts.

What are the advantages of these special functions?

These special functions mean that expensive supplementary equipment does not have to be purchased, and space is saved in the electrical cabinet. Furthermore, the amount of wiring is reduced, which in turn reduces the installation time and costs.

SIMOCODE-DP motor protection and control device



In addition to the comprehensive functions of the 3RB12 overload relay, which provides full motor protection, the SIMOCODE-DP motor protection and control device offers a host of additional, valuable advantages: The most outstanding are the comprehensive diagnostic and control functions and the high performance communication via PROFIBUS-DP. Details on the range of accessories and more information on the possible applications are provided under: www.siemens.com/simocode-dp

Thermistor motor-protection devices and temperature-monitoring relays

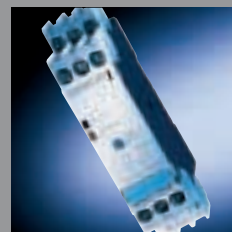

Thermistor motor-protection devices and temperature-monitoring relays are used to directly protect motors against overheating. It is especially advantageous to directly monitor the motor winding temperature if the motor rated current does not mean an excessive load temperature. This is the case, for example, for irregular intermittent duty, excessively high operating cycles, increased ambient temperatures, or restricted cooling medium flow. In this case, the direct winding temperature measurement provides optimum motor protection. A detailed overview of the possibilities and performance features of the thermistor motor protection devices and temperature monitoring relays is provided under: www.siemens.com/simirel

Technology in detail: the **overload relays**

3RU11 thermal overload relay and 3RB10 solid-state overload relay

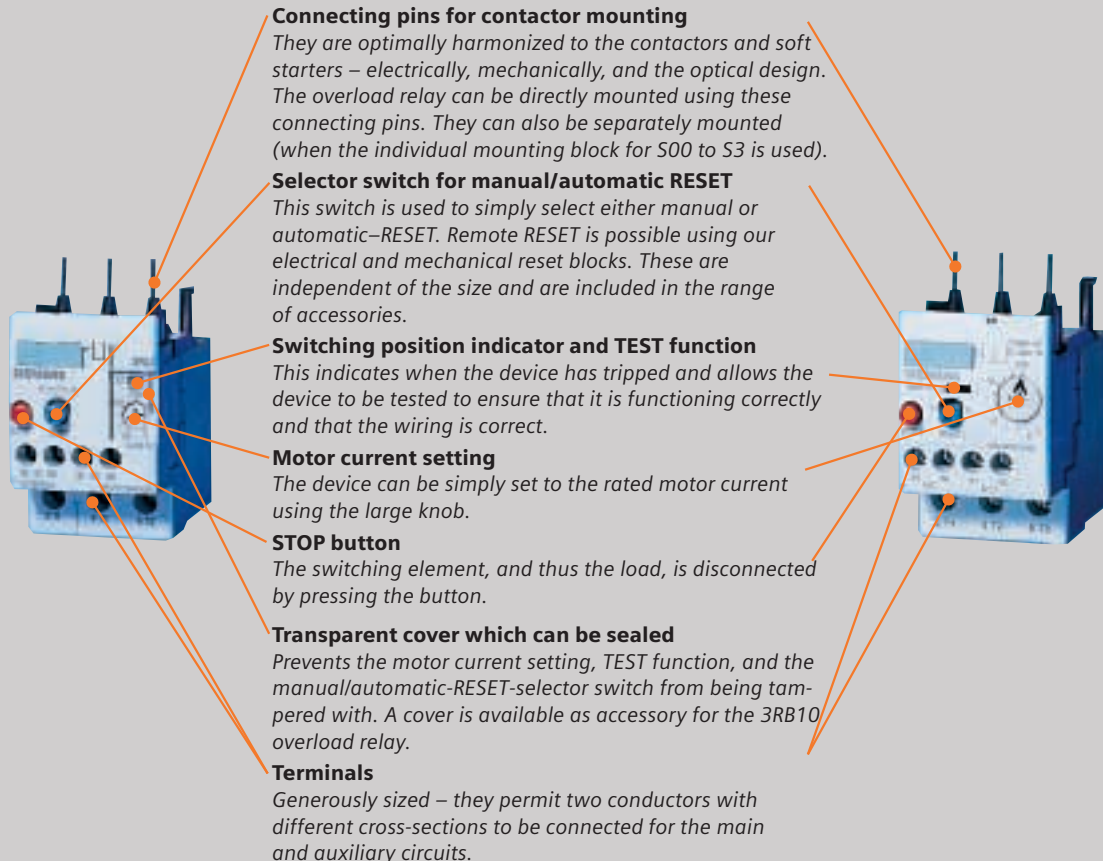

Connecting pins for contactor mounting

They are optimally harmonized to the contactors and soft starters – electrically, mechanically, and the optical design. The overload relay can be directly mounted using these connecting pins. They can also be separately mounted (when the individual mounting block for S00 to S3 is used).

Selector switch for manual/automatic RESET

This switch is used to simply select either manual or automatic-RESET. Remote RESET is possible using our electrical and mechanical reset blocks. These are independent of the size and are included in the range of accessories.

Switching position indicator and TEST function

This indicates when the device has tripped and allows the device to be tested to ensure that it is functioning correctly and that the wiring is correct.

Motor current setting

The device can be simply set to the rated motor current using the large knob.

STOP button

The switching element, and thus the load, is disconnected by pressing the button.

Transparent cover which can be sealed

Prevents the motor current setting, TEST function, and the manual/automatic-RESET-selector switch from being tampered with. A cover is available as accessory for the 3RB10 overload relay.

Terminals

Generously sized – they permit two conductors with different cross-sections to be connected for the main and auxiliary circuits.

3RB12 solid-state overload relay

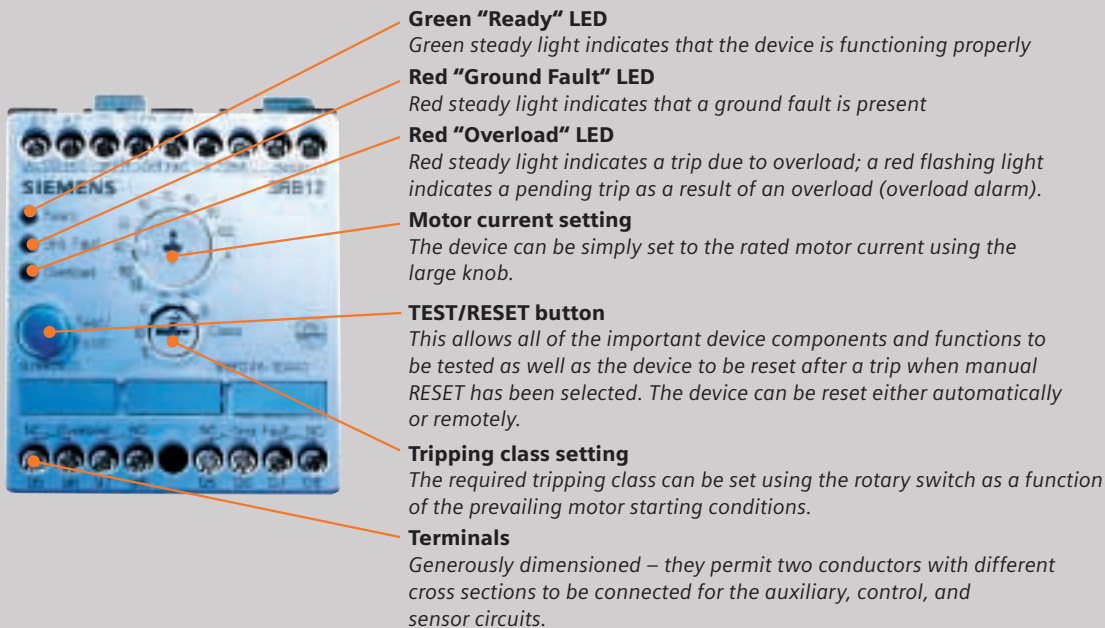

Green "Ready" LED

Green steady light indicates that the device is functioning properly

Red "Ground Fault" LED

Red steady light indicates that a ground fault is present

Red "Overload" LED

Red steady light indicates a trip due to overload; a red flashing light indicates a pending trip as a result of an overload (overload alarm).

Motor current setting

The device can be simply set to the rated motor current using the large knob.

TEST/RESET button

This allows all of the important device components and functions to be tested as well as the device to be reset after a trip when manual RESET has been selected. The device can be reset either automatically or remotely.

Tripping class setting

The required tripping class can be set using the rotary switch as a function of the prevailing motor starting conditions.

Terminals

Generously dimensioned – they permit two conductors with different cross sections to be connected for the auxiliary, control, and sensor circuits.

DETAIL

The heat flares in the Orion nebula can be seen both in the Northern as well as in the Southern heavens.





There are many uncontrollable **risks, phenomena, and explosions** in space.

Device type	Circuit-breakers for motor protection	Circuit-breakers for motor protection with overload relay function	Circuit-breakers for starter combinations	Circuit-breakers for transformer protection	Thermal overload relay
Main Order No.	3RV10	3RV11	3RV13	3RV14	3RU11
Principle of operation	Thermal/magnetic	Thermal/magnetic	Magnetic	Thermal/magnetic	Thermal
Current range	0,11 A to 100 A	0,11 A to 100 A	0,16 A to 100 A	0,11 A to 40 A	0,11 A bis 100 A
Protective functions					
Short-circuit protection	x	x	x	x	With fuses or circuit-breaker
Overload protection	x	x	–	x	x
Phase imbalance	x	x	–	x	x
Phase failure	x	x	–	x	x
Thermal protection	–	–	–	–	–
Ground fault detection	–	–	–	–	–
Tripping classes					
CLASS 10	x	x	Not relevant	x	x
CLASS 20	x (from 11 A)	–	Not relevant	–	–
CLASS 5 to 30, can be selected	–	–	Not relevant	–	–
Features					
Wide setting range	–	–	Not relevant	–	–
Manual RESET	x	x (only for short-circuit)	x	x	x
Automatic RESET	–	x (only for overload)	–	–	x
Test function	x	x	x	x	x
Auxiliary contacts	Accessories	1NO + 1NC for overload signal	Accessories	Accessories	1NO + 1NC
Cage Clamp connections					
Main current path	x (up to 12 A)	–	–	–	x (to 12 A)
Auxiliary current path	x (auxiliary contact)	x (auxiliary contact)	x (auxiliary contact)	x (auxiliary contact)	x
Load feeder configuration					
Directly mounted onto the contactor and soft starter	x	x	x	x	x
Individual mounting	x	x	x	x	x (with connection carrier)
Applications to protect					
Three-phase loads	x	x	x	x	x
DC loads	x	x	x	x	x
Single-phase AC loads	x	x	x	x	x
Communications possible via					
	AS-Interface	AS-Interface	AS-Interface	AS-Interface	PLC-compatible auxiliary contact

Only we have the right protection: **you have the choice.**

Solid-state overload relay	Solid-state overload relay for full motor protection	Motor protection and control device SIMOCODE DP	Thermistor-motor protection	Temperature monitoring relay
3RB10	3RB12	3UF5	3RN1	3RS1040/3RS1041
solid-state	solid-state	solid-state	solid-state	solid-state
0,1 A bis 630 A	0,25 A bis 820 A	0,25 A bis 820 A	Not relevant (response temperature is defined by the thermistor)	-99 °C to 500 °C
With fuses or circuit-breaker	With fuses or circuit-breaker	With fuses or circuit-breaker	With fuses or circuit-breaker	With fuses or circuit-breaker
x	x	x	-	-
x	x	x	-	-
x	x	x	-	-
-	x	x	x	x
-	x	x	-	-
x	-	-	Not relevant	Not relevant
x	-	-	Not relevant	Not relevant
-	x	x	Not relevant	Not relevant
x	x	x	Not relevant	Not relevant
x	x	x	x (Exception: 3RN1000/1010)	x
x	x	x	x	x
x	x	x	x (Exception: 3RN1000/1010)	-
1NO + 1NC	2NO + 2NC	4NO + 4NC (Can be expanded to 8NO or 8NC)	1NO + 1NC or 2 NC	1NO + 2NC
-	-	-	Not relevant	Not relevant
-	-	-	x	x
x	x (not 3RB1246)	x (from 3UF5031)	-	-
x (S00 to S3 with connection carrier)	x	x	x	x
x	x	x	x	x
-	-	-	x	x
-	x	x	x	x
PLC-compatible auxiliary contact	Analog output	PROFIBUS-DP integrated or RS 232	PLC-compatible auxiliary contact	PLC-compatible auxiliary contact

SITOR semiconductor protection fuses for fast short-circuit interruption.



This fuse system prevents burning and scalding in the immediate area around the short circuit caused by the effects of arcing. This means that the effects of the short-circuit cannot extend to other equipment that would destroy it.

Your advantages:

- Extremely fast response: The higher the short-circuit, the faster the SITOR fuse ruptures. Peak currents are interrupted within milliseconds.
- Safe, reliable protection for power semiconductors.
- Interrupting capacity up to 200 kA.
- Always functions with 100 percent reliability: SITOR fuses can be simply replaced after interrupting overloads or short-circuits.
- High-precision fuse technology without mechanically complex mechanisms.
- Functions perfectly after decades of use.
- Even with close fuse grading using cascaded SITOR fuses, only the area that is involved is selectively shut down.
- Fuse-element link conductors are manufactured with the highest precision and close tolerances.
- Good price-performance ratio: increasing performance requirements don't automatically mean higher costs. The space-saving potential increases by a multiple with the current rating that has to be protected.

OVERVIEW

Bi-stable auxiliary contacts

When the control voltage fails, bi-stable overload relays do not change their “tripped” or “not tripped” status. The auxiliary contacts only change state when there is an overload condition and when the supply voltage is connected. This means that these devices are suitable for plants and systems where the control voltage is separately monitored.

Cage Clamp connection

This is a screwless connection system where the conductors are clamped using a Cage Clamp for vibration- and shock-proof connections. Single-, multi-, and finely- stranded conductors can be connected, with or without end sleeve. Each device connection point has two cage clamps that operate independently of one another. One conductor can be clamped in each of these.

Current-dependent protection

Current-dependent protective devices indirectly monitor the motor winding temperature by following through the feeder cables.

Ground fault

When a phase conductor or an operationally insulated neutral conductor has an electrical connection to ground or to grounded parts as a result of a fault (also caused by an arc).

Heavy-duty starting

Heavy-duty starting is considered to be the case if a motor requires more than 10 seconds to reach its rated speed after being connected to the power source due to specific load characteristics (e.g. when accelerating large centrifuges). Special protective devices, with the appropriate tripping characteristics, are required to protect motors that start heavy-duty loads.

Load feeder

Combinations of switching devices to protect and switch loads, e.g. motors, ohmic loads, transformers. Combinations such as these can comprise circuit-breakers and contactors (fuseless load feeders) or contactors and overload relays (fused load feeders).

Mono-stable auxiliary contacts

Mono-stable overload relays go into the “tripped” position when the control voltage fails (> 200 ms), and when the voltage returns they return to the original state before the control failed. This means that these devices are suitable for plants and systems where the control voltage is not specifically monitored.

Normal starting

Normal starting occurs when a motor requires less than 10 seconds to reach its rated speed after it has been connected to the power source.

Overload

Operating conditions in a circuit that is operating fault-free, which results in an overcurrent condition. An overload such as this can cause damage if it is maintained over a longer period of time and the load is not disconnected.

Phase failure

Phase failure means that one phase has been interrupted. The cause of an interrupted phase can be an interrupted cable or a blown fuse. In this situation, a motor can very quickly overheat.

Phase failure protection

An integrated function which, when a phase fails and the current increases in the two remaining phases, interrupts all of the phases before the motor is thermally damaged.

Phase imbalance protection

This function ensures motor overload protection, even for non-symmetrical loads (asymmetry of the line supply). This means that the motor is not thermally damaged when fed from non-symmetrical line supplies.

Recovery time

Interval which is required after a device has tripped until it can be reset.

Short-circuit

Connection with a negligibly low impedance between conductors that are at different operational voltages. The current is a multiple of the current that flows under normal operating conditions. This can result in thermal or mechanical stressing of the switchgear and parts of the plant.

Single-phase operation

Single-phase operation is an abnormal operating condition of a three-phase asynchronous motor in which one of the power supply phases is interrupted (e.g. caused by an interrupted conductor or a blown fuse).

Straight-through transformer technology

With this system, the main circuit conductors are directly routed in a short-circuit-proof fashion through the openings of the relay directly at the contactor connections.

SIRIUS and open questions: **definitions and information.**

Temperature-dependent protection

Temperature-dependent protective devices directly and locally measure the temperature using a temperature sensor that is integrated in the motor winding.

Tripping class

The tripping class defines the time intervals within which the protective devices must trip from the cold state for a symmetrical three-phase load with a $7.2 \times$ setting current I_e .
The tripping times are:

CLASS 10A	between 2 - 10 seconds
CLASS 10	between 4 - 10 seconds
CLASS 20	between 6 - 20 seconds
CLASS 30	between 9 - 30 seconds

Tripping characteristic

The tripping characteristic defines the interdependency between the tripping time and tripping current.

Siemens AG

Automation and Drives

Low Voltage Controls and Distribution

P.O. Box 32 40, D-91050 Erlangen

www.siemens.com/sirius

The information provided in this brochure contains merely general descriptions or characteristics of performance which in case of actual use do not always apply as described or which may change as a result of further development of the products. An obligation to provide the respective characteristics shall only exist if expressly agreed in the terms of contract.