



3M™ Cold Shrink QT-III Silicone Rubber Skirted Termination Kit

With High-K Stress Relief

For Jacketed Concentric Neutral (JCN) Cable and Concentric Neutral (CN) Cable

7652-S-4, 7652-S-4 (L), 7653-S-4, 7654-S-4, 7655-S-4,
7655-S-4 (L), 7656-S-4

Instructions

IEEE Std. No. 48

Class 1 Termination

25/28 kV Class

150 kV BIL

CAUTION

Working around energized systems may cause serious injury or death. Installation should be performed by personnel familiar with good safety practice in handling electrical equipment. De-energize and ground all electrical systems before installing product.

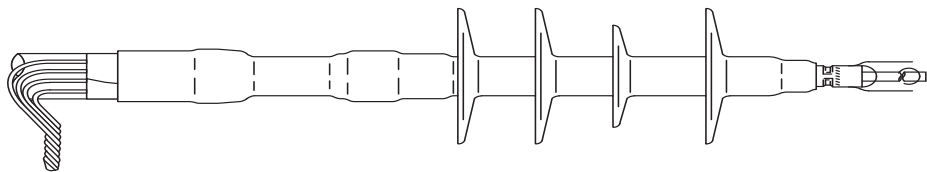

Jacketed Concentric Neutral (JCN) Cable

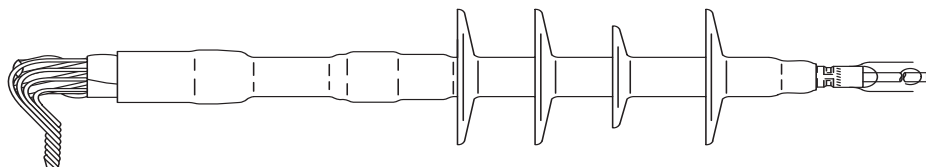

Concentric Neutral (CN) Cable

July 2021

78-8117-0588-4 Rev J

1.0 Kit Contents

- 1 High-K, Tracking Resistant, Silicone Rubber Termination
- 2 Strips Scotch® Mastic Strip 2230 (black with white release liners, bagged)
- 1 Instruction Sheet

NOTE: Do Not use knives to open plastic bags.

Kit Selection Tables

NOTE: Final Determination Factor is cable insulation diameter.

For Use With Compression Lugs or Connectors						
Kit Number	Primary Insulation O.D. Range	Jacket O.D. Range	Conductor Size Range (AWG & kcmil)			
			5 kV	8 kV	15 kV	25/28 kV
7652-S-4	0.64" – 1.08" (16,3 – 27,4 mm)	0.97" – 1.48" (24,6 – 37,6 mm)	4/0 – 400 —	3/0 – 300 —	2 – 4/0 (35 – 120 mm ²)	2 – 1/0 (35 – 50 mm ²)
7653-S-4	0.72" – 1.29" (18,3 – 32,8 mm)	1.04" – 1.60" (26,4 – 40,6 mm)	300 – 500 —	250 – 500 —	2/0 – 300 (70 – 150 mm ²)	2 – 4/0 (35 – 120 mm ²)
7654-S-4	0.83" – 1.53" (21,1 – 38,9 mm)	1.12" – 1.87" (28,4 – 47,5 mm)	500 – 750 —	350 – 700 —	4/0 – 500 (120 – 240 mm ²)	2/0 – 250 (70 – 150 mm ²)
7655-S-4	1.05" – 1.80" (26,7 – 45,7 mm)	1.39" – 2.40" (35,3 – 61,0 mm)	700 – 1500 —	600 – 1250 —	500 – 1000 (240 – 500 mm ²)	250 – 800 (150 – 400 mm ²)
7656-S-4	1.53" – 2.32" (38,9 – 58,9 mm)	1.84" – 2.80" (46,8 – 71,1 mm)	1750 – 2000 —	1500 – 2000 —	1250 – 2000 (625 – 1000 mm ²)	900 – 1750 (500 – 800 mm ²)

Table 1

For Use With 3M™ Mechanical Shearbolt Lugs QL2 Series: Two Hole					
Kit Number	Primary Insulation O.D. Range	Jacket O.D. Range	Conductor Size Range (AWG & kcmil)		3M™ Mechanical Shearbolt Lugs QL2 Series: Two Hole Part Number
			15 kV	25/28 kV	
7652-S-4(L)	0.69" – 1.22" (17,5 – 31,0 mm)	0.97" – 1.48" (24,6 – 37,6 mm)	1/0 – 4/0 (60 – 120 mm ²)	—	QL2-A-2-250
7653-S-4	0.72" – 1.29" (18,3 – 32,8 mm)	1.04" – 1.60" (26,4 – 40,6 mm)	2/0 – 250 (70 – 150 mm ²)	2 - 4/0 (35 - 120 mm ²)	QL2-A-2-250
7654-S-4	0.83" – 1.53" (21,1 – 38,9 mm)	1.12" – 1.87" (28,4 – 47,5 mm)	—	2/0 - 250 (70 - 150 mm ²)	QL2-A-2-250
7654-S-4	0.83" – 1.53" (21,1 – 38,9 mm)	1.12" – 1.87" (28,4 – 47,5 mm)	4/0 – 350 (120 – 150 mm ²)	2/0 - 250 (70 - 150 mm ²)	QL2-A-1/0-350
7654-S-4	0.83" – 1.53" (21,1 – 38,9 mm)	1.12" – 1.87" (28,4 – 47,5 mm)	—	4/0 - 250 (120 - 150 mm ²)	QL2-A-4/0-600
7655-S-4	1.05" – 1.80" (26,7 – 45,7 mm)	1.39" – 2.40" (35,3 – 61,0 mm)	500 (240 mm ²)	250-500 (150-240 mm ²)	QL2-A-4/0-600
7655-S-4	1.05" – 1.80" (26,7 – 45,7 mm)	1.39" – 2.40" (35,3 – 61,0 mm)	500 – 750 (240 – 325 mm ²)	350 – 750 (185 – 325 mm ²)	QL2-A-350-750
7655-S-4(L)	1.15" – 1.98" (29,2 – 50,3 mm)	1.39" – 2.40" (35,3 – 61,0 mm)	750 – 1000 (400 – 500 mm ²)	500 – 750 (240 – 325 mm ²)	QL2-A-500-1000
7656-S-4	1.53" – 2.32" (38,9 – 58,9 mm)	1.84" – 2.80" (46,7 – 71,1 mm)	1250 (625 mm ²)	1000 -1250 (600 - 625 mm ²)	QL2-A-1000-1250

Table 2A

For Use with 3M™ Shearbolt Stem Connector QP 7-4/0					
Kit Number	Primary Insulation O.D. Range	Jacket O.D. Range	Conductor Size Range (AWG & kcmil)		Part Number
			15 kV	25/28 kV	
			7652-S-4	0.64" – 1.08" (16,3 – 27,4 mm)	
7652-S-4 (L)	0.69" – 1.22" (17,5 – 31,0 mm)	0.97" – 1.48" (24,6 – 37,6 mm)	1/0 – 4/0 (60 – 120 mm²)	-----	QP 7-4/0
7653-S-4	0.72" – 1.29" (18,3 – 32,8 mm)	1.04" – 1.60" (24,4 – 40,6 mm)	2/0 – 4/0 (70 – 120 mm²)	2 – 4/0 (35 – 120 mm²)	QP 7-4/0
7654-S-4	0.83" – 1.53" (21,1 – 38,9 mm)	1.12" – 1.87" (28,4 – 47,5 mm)	-----	2/0 – 4/0 (70 – 120 mm²)	QP 7-4/0

Table 2B

Instructions for Jacketed Concentric Neutral (JCN) Cable

2.0 Prepare Cable

- 2.1 Check to be sure cable size fits within kit size range as shown in Table 1 (For Use With Compression Lugs or Connectors), Table 2A (For Use With 3M Mechanical Shearbolt Lugs QL2 Series: Two Hole) or Table 2B (For use With 3M Shearbolt Stem Connector QP 7-4/0).
- 2.2 Train cable into position and cut to length required for installation. Allow sufficient neutral wire length for grounding connection.
- 2.3 Prepare cable using dimensions shown in Figure 1. **BE SURE TO ALLOW FOR DEPTH OF TERMINAL LUG OR CONNECTOR.** If using 3M Shearbolt Lugs QL2 Series: Two Hole, 3M Shearbolt Stem Connector QP 7-4/0 or 3M Mechanical Shearbolt Connector QCI Series, proceed to Step 2.4. If using a Crimp Type (Compression) lug, measure the depth of the barrel, or if using a Crimp Type (Compression) connector, measure to the barrel center stop/midpoint, and see the NOTE below, in order to calculate the Insulation Removal Length. Table 4 can be used to assist in calculating the total Jacket Removal Length when using a compression lug or connector.

NOTE: Provide additional exposed conductor distance to account for growth during crimping of ALUMINUM lugs or connectors as follows:

Aluminum Lug and Connector Growth Allowance	2 - 350 1/4" (6 mm)	400 - 650 1/2" (13 mm)	750 - 1000 3/4" (19 mm)	1250 - 2000 Field Determined
---	------------------------	---------------------------	----------------------------	---------------------------------

Table 3

NOTE: It is imperative to remove all remnants of the semi-con layer, even if the semi-con layer comes off as one layer. There should not be any remaining black areas, or particles, on the cable insulation layer.

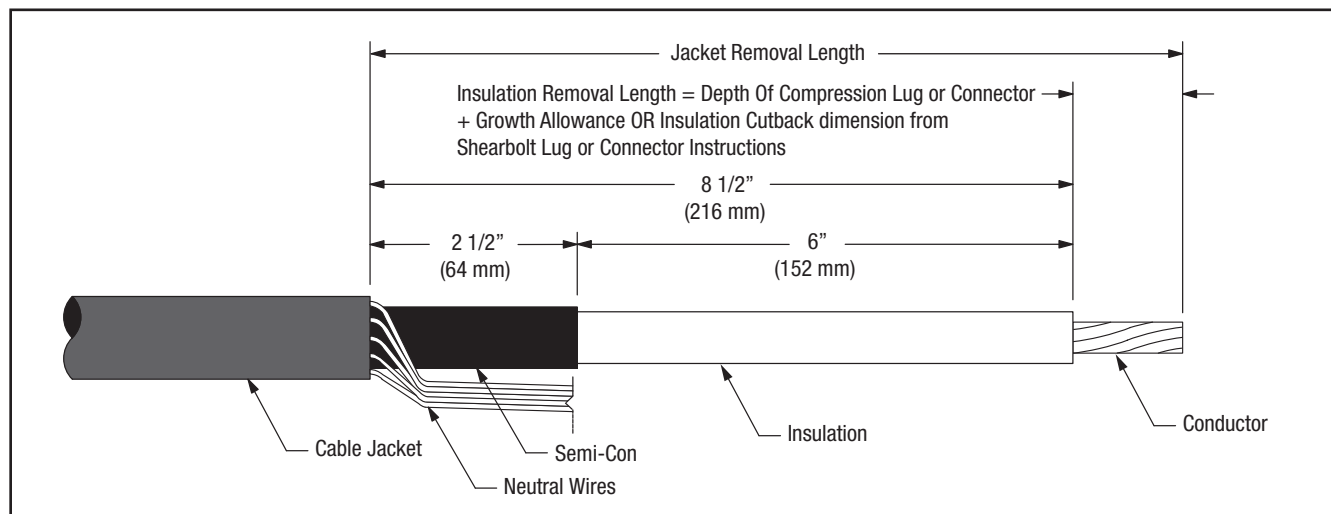

Figure 1

3M™ Cold Shrink QT-III Silicone Rubber Skirted Termination Kit With High-K Stress Relief

Jacket Removal Calculation Table - Jacketed Concentric Neutral (JCN) Cable - Crimp Type (Compression) Lugs / Connectors - 7652-S-4, 7652-S-4(L), 7653-S-4, 7654-S-4, 7655-S-4, 7655-S-4(L), 7656-S-4			
CABLE PREPARATION ITEM	Inches -Add this column-	mm -Add this column-	NOTES
Insulation Length	8.5"	216 mm	Value from Figure 1
Insulation Removal Length = Depth of Crimp Type (Compression) Terminal Lug or Connector Barrel (See NOTES column.)	+	+	Measure full depth of bore for lugs and to the center stop for connectors.
Growth Allowance (Aluminum Only) for Crimp Type (Compression) Lug / Connector (See NOTES column.)	+	+	See Table 3 for correct growth allowance. This measurement applies only to Aluminum lugs / connectors.
TOTAL JACKET REMOVAL LENGTH	=	=	

Table 4

2.4 If using 3M Mechanical Shearbolt Lugs QL2 Series: Two Hole, 3M Shearbolt Stem Connector QP 7-4/0 or 3M Mechanical Shearbolt Connector QCI Series, refer to the Instructions that are packed with the 3M Shearbolt product for the Insulation Cutback length for the specific 3M Shearbolt Lug or Connector being used. Table 5 can be used to assist in calculating the total Jacket Removal Length when using 3M Mechanical Shearbolt Lugs QL2 Series: Two Hole, 3M Shearbolt Stem Connector QP 7-4/0 or 3M Mechanical Shearbolt Connector QCI Series.

Jacket Removal Calculation Table - Jacketed Concentric Neutral (JCN) Cable - 3M™ Mechanical Shearbolt Lugs QL2 Series / 3M™ Mechanical Shearbolt Connector QCI Series / 3M™ Shearbolt Stem Connector QP 7-4/ 0- 7652-S-4(L), 7653-S-4, 7654-S-4, 7655-S-4, 7655-S-4(L), 7656-S-4			
CABLE PREPARATION ITEM	Inches -Add this column-	mm -Add this column-	NOTES
Insulation Length	8.5"	216 mm	Value from Figure 1
Insulation Removal Length = Depth of 3M Mechanical Shearbolt QL2 Series Terminal Lug, 3M Shearbolt Stem Connector QP 7-4/0 or QCI Series Connector Barrel (See NOTES column.)	+	+	Obtain Insulation Removal Length: For 3M Mechanical Shearbolt Lugs or Shearbolt Stem Connector see 3M™ Mechanical Shearbolt Lugs QL2 Series: Two Hole or 3M™ Shearbolt Stem Connector QP 7-4/0 Instructions. For 3M Mechanical Shearbolt Connectors see 3M™ Mechanical Shearbolt Connectors QCI Series Instructions.
TOTAL JACKET REMOVAL LENGTH	=	=	

Table 5

2.5 Select a Scotch® Mastic Strip 2230 from kit and remove white release liners. Using light tension, apply a **SINGLE WRAP** of mastic around the cable jacket 1/4" (6 mm) from cut edge (Figure 2). Cut off excess.

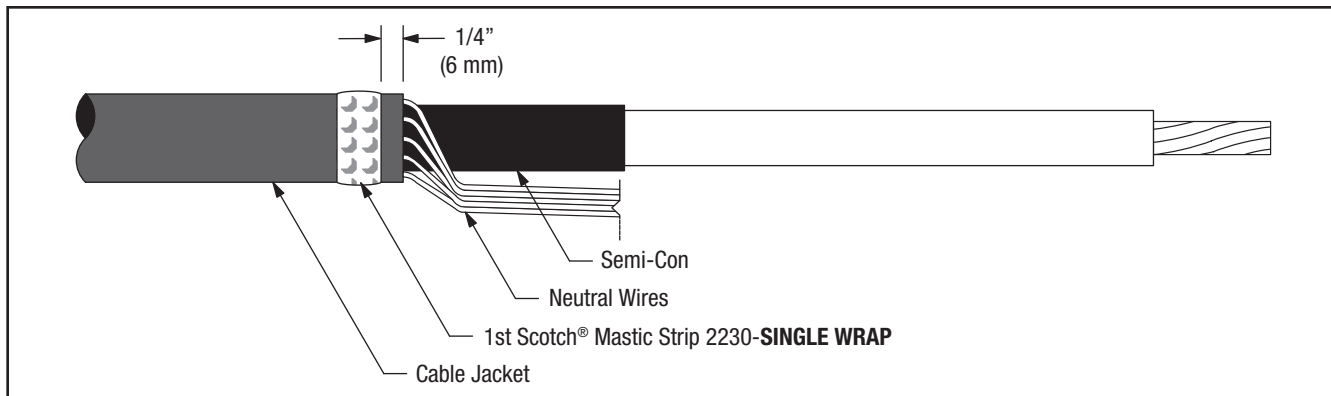

Figure 2

2.6 Bend neutral wires back over applied sealing mastic and secure to cable jacket **4 1/2" (114 mm)** from cable semi-con edge using vinyl tape (see NOTE and Figure 3).

NOTE: Position vinyl tape with care, it also serves as a marker for positioning the termination.

2.7 Select second Scotch® Mastic Strip 2230 from kit and remove white release liners. Apply a second **SINGLE WRAP** of mastic over the neutral wires and previously applied mastic (Figure 3). Cut off excess.

2.8 Compress neutral wires into mastic by over-wrapping seal strips with two highly stretched layers of electrical grade vinyl tape (Figure 3). **Be sure to cover all exposed mastic AND TO READ THE CONCENTRIC NEUTRAL WIRES NOTE, OR THE SPECIAL FLAT STRAP NEUTRAL WIRES NOTE, BELOW CONCERNING APPLICATION OF THE TWO HIGHLY STRETCHED LAYERS OF ELECTRICAL GRADE VINYL TAPE.**

CONCENTRIC NEUTRAL WIRES NOTE: DO NOT completely cover the concentric neutral wires with electrical grade vinyl tape when applying over the Scotch® Mastic Strip 2230 per Step 2.8. LEAVE AT LEAST 1" (25 MM) OF EXPOSED CONCENTRIC NEUTRAL WIRES between the Vinyl Tape Marker applied in step 2.6 and the start of the two highly stretched half-lapped layers of electrical grade vinyl tape covering the Scotch® Mastic Strip 2230 applied in Step 2.8.

SPECIAL FLAT STRAP NEUTRAL WIRES NOTE: If using flat strap neutral cable, cover the flat strap neutral wires starting 1" (25 mm) from the Vinyl Tape Marker (that was applied in Step 2.6) and proceed towards the edge of the semi-con layer where the flat strap neutrals are bent back onto the cable jacket, using two half-lapped layers of electrical grade vinyl tape. Be sure to leave 1" (25 mm) of exposed flat strap neutral wires between the Vinyl Tape Marker and the start of the two half-lapped layers of electrical grade vinyl tape covering the flat strap neutral wires. The vinyl tape can extend onto the semi-con layer up to 1/4" (6 mm).

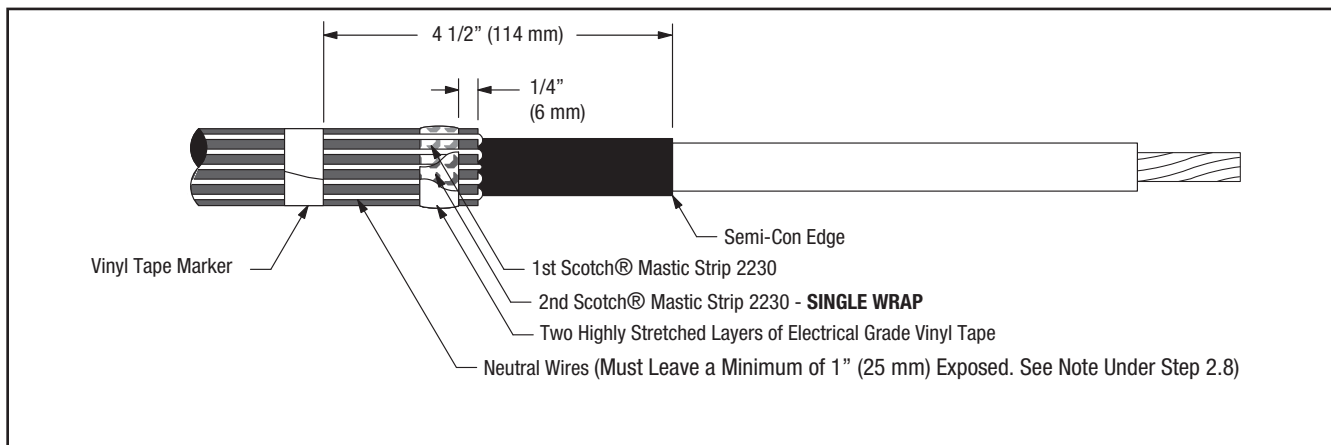

Figure 3

3.0 Install Lug or Connector

Important Packaging Notice

In order to make sure that you receive an undamaged termination, this 3M Cold Shrink QT-III Silicone Rubber Termination is packed with a RED SHIPPING CORE inside of the white core. Please remove the red shipping core BEFORE you install the termination. This shipping core can be recycled with other polypropylene waste.

- 3.1 Check to insure 3M Cold Shrink QT-III Silicone Rubber Termination assembly fits over the selected lug or connector BEFORE installing the lug or connector. If lug or connector (Figure 4) will not fit through the termination core, clean the insulation (per Step 4.0) and slide termination on cable before installing Lug or Connector. **DO NOT REMOVE CORE AT THIS TIME.**

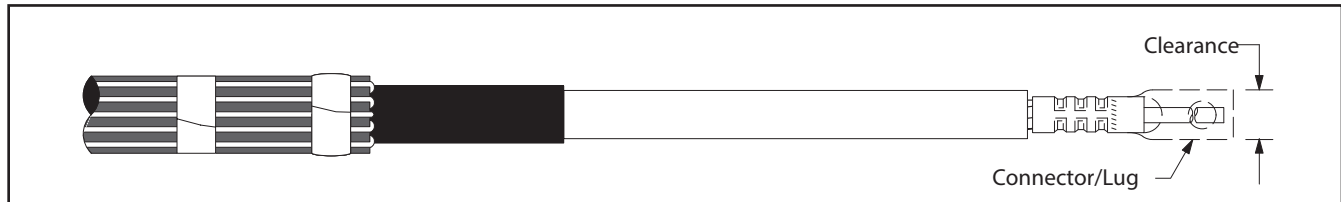

Figure 4

- 3.2 For 3M Compression Lugs and 3M Stem Connectors:
- Refer to pages 12 - 14 for 3M Connector and Lug crimping information.
 - For Aluminum Conductors - Thoroughly wire brush conductor strands to remove aluminum oxide layer. Insert conductor into lug or connector and then remove conductor. This will transfer some of the antioxidant paste onto the conductor. Wire brush the antioxidant paste into the strands. Immediately insert conductor into lug or connector barrel as far as it will go.

NOTE: Die/crimper head rotation between consecutive crimps is RECOMMENDED

- Position connector or lug and crimp according to manufacturer's directions. Remove excess oxide inhibitor and sharp crimp flashings following crimping.
- 3.3 For 3M Mechanical Shearbolt Lugs QL2 Series: Two Hole, 3M Shearbolt Stem Connector QP 7-4/0 or 3M Mechanical Shearbolt Connector QCI Series:
- Refer to the Instructions that are packed with the 3M Shearbolt product for the installation procedures.

4.0 Clean Cable Insulation and Lug Barrel Using Standard Practice

- 4.1 If abrasive must be used:
- Use on insulation only. **DO NOT USE ABRASIVE ON SEMI-CON INSULATION SHIELD!**
 - Use **ONLY aluminum oxide abrasive**; grit 120 or finer.
 - Be careful not to reduce the cable insulation diameter below that allowed by the kit.
- 4.2 Wipe the cable insulation, and lug or connector, with an approved cable cleaner/solvent (such as 3M Cable Cleaning Solvent CC Series) **AND ALLOW IT TO DRY BEFORE INSTALLING TERMINATION. A clean lint-free cloth, inexpensive paper towel or 3M Cable Cleaning Pads CC-DRY (not supplied with kit) can be used to dry the insulation surface if air drying time is of concern. DO NOT ALLOW SOLVENT TO TOUCH SEMI-CON INSULATION SHIELD!**

5.0 Install Termination

- 5.1 Slide the termination body onto the cable and remove core. Make sure the termination body (not the core) is butted up to the edge of the vinyl tape marker previously applied (Figure 5). Pull the core while unwinding, counterclockwise, starting with the loose end (Figure 5). Be sure to alternate the pulling and unwinding actions (pull-unwind-pull-unwind-etc.) to help prevent the core material from binding up as the core is being removed.

NOTE: Once the termination body makes contact over the mastic seal area, there is no need to continue supporting the assembly. DO NOT PUSH OR PULL ON THE TERMINATION ASSEMBLY WHILE UNWINDING THE CORE.

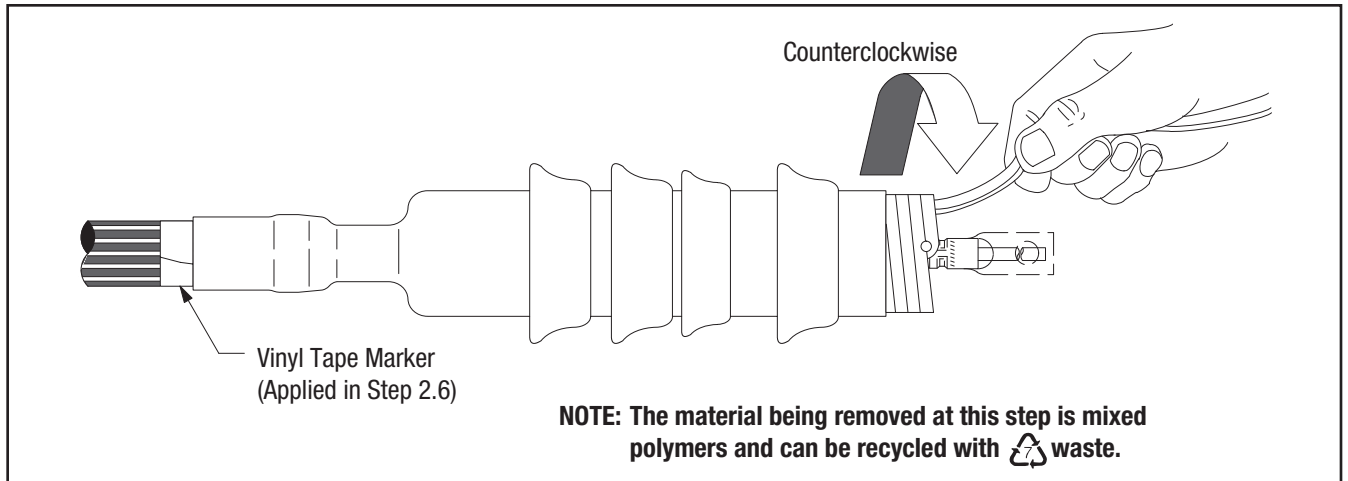

Figure 5

5.2 Collect all concentric neutral wires together (Figure 6) and connect to system ground according to standard practice.

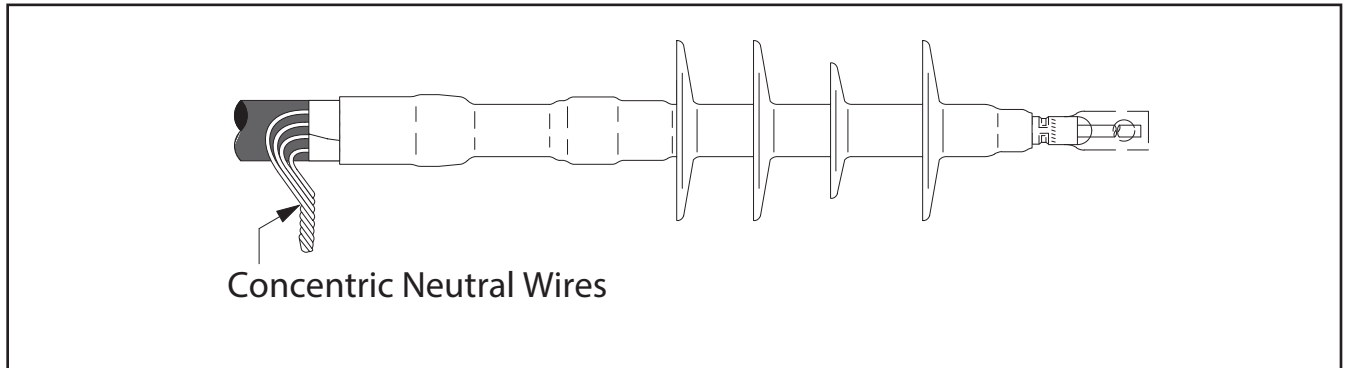
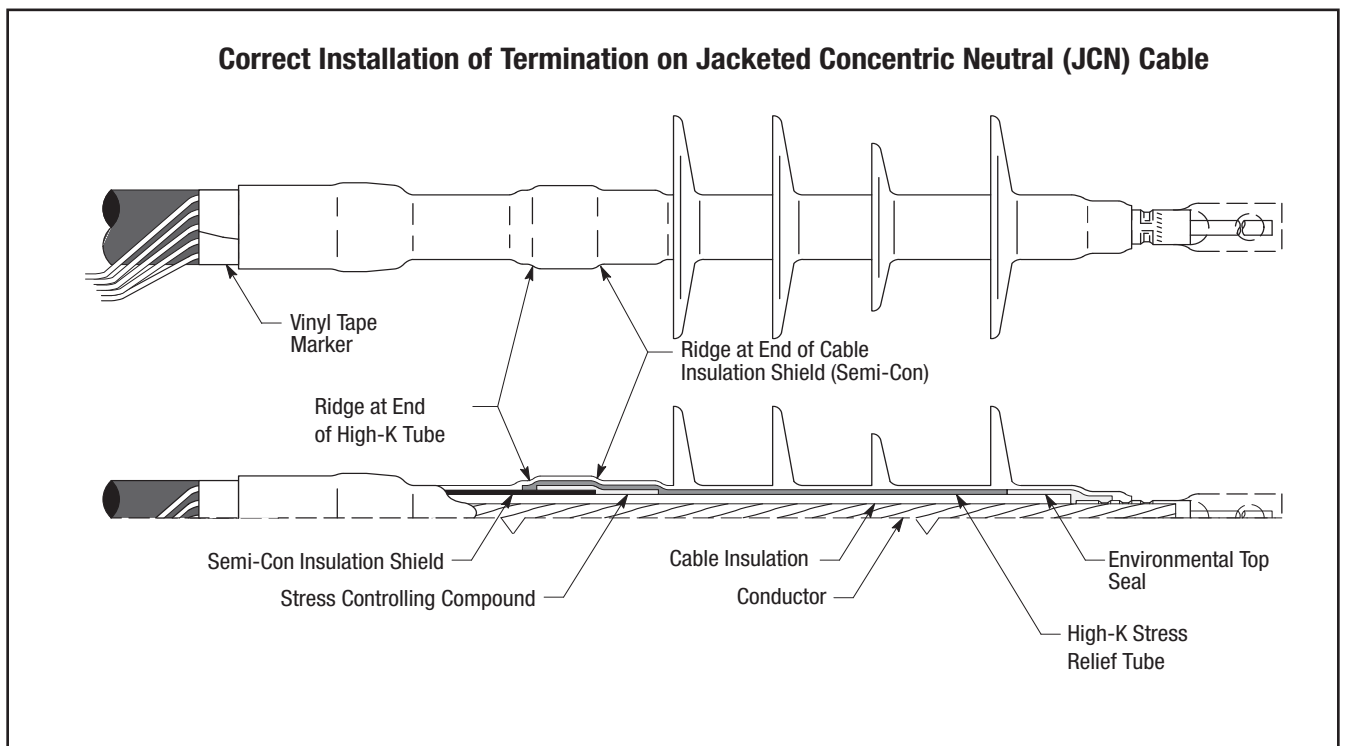

Figure 6



Instructions for Concentric Neutral (CN) Cable

6.0 Prepare Cable

- 6.1 Check to be sure cable size fits within kit range as shown in Table 1 (For Use With Compression Lugs or Connectors), Table 2A (For Use With 3M Mechanical Shearbolt Lugs QL2 Series: Two Hole) or Table 2B (For Use With 3M Shearbolt Stem Connector QP 7-4/0).
- 6.2 Train cable into position and cut to length required for installation. Allow sufficient neutral wire length for grounding connection.
- 6.3 Prepare cable using dimensions shown in Figure 7. **BE SURE TO ALLOW FOR DEPTH OF TERMINAL LUG OR CONNECTOR.** If using 3M Shearbolt Lugs QL2 Series: Two Hole, 3M Shearbolt Stem Connector QP 7-4/0 or 3M Mechanical Shearbolt Connector QCI Series, proceed to Step 6.4. If using a Crimp Type (Compression) lug, measure the depth of the barrel. If using a Crimp Type (Compression) connector, measure to the barrel center stop/midpoint, and see the NOTE below in order to calculate the Insulation Removal Length. Table 7 can be used to assist in calculating the total Jacket Removal Length when using a compression lug or connector.

NOTE: Provide additional exposed conductor distance to account for growth during crimping of ALUMINUM lugs or connectors as follows:

Aluminum Lug and Connector Growth Allowance	2 - 350 1/4" (6 mm)	400 - 650 1/2" (13 mm)	750 - 1000 3/4" (19 mm)	1250 - 2000 Field Determined
---	------------------------	---------------------------	----------------------------	---------------------------------

Table 6

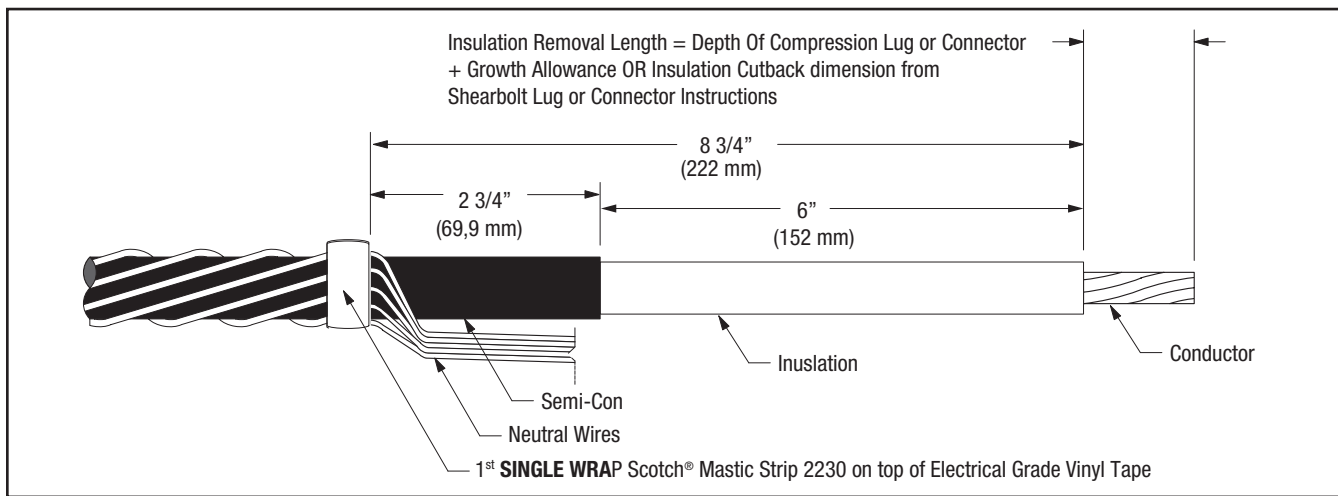

Figure 7

NOTE: It is imperative to remove all remnants of the semi-con layer, even if the semi-con layer comes off as one layer. There should not be any remaining black areas, or particles, on the cable insulation layer.

- 6.4 If using 3M Shearbolt Lugs QL2 Series: Two Hole, 3M Shearbolt Stem Connector QP 7-4/0 or 3M Shearbolt Connector QCI Series, refer to the Instructions that are packed with the 3M Shearbolt product for the Insulation Cutback length for the specific 3M Shearbolt Lug or Connector being used. Table 8 can be used to assist in calculating the total Jacket Removal Length when using 3M Shearbolt Lugs QL2 Series: Two Hole, 3M Shearbolt Stem Connector QP 7-4/0 or 3M Shearbolt Connector QCI Series.
- 6.5 Secure neutral wires to cable with several highly stretched layers of electrical grade vinyl tape around the cable and neutral wires 2 3/4" (69,9 mm) from cut edge of cable semi-con (Figure 7).
- 6.6 Select a Scotch® Mastic Strip 2230 from kit and remove white release liners. Using light tension, apply a **SINGLE WRAP** of mastic around the cable and neutral wires 2 3/4" (69,9 mm) from cut edge of cable semi-con, directly on top of vinyl tape (Figure 7). Cut off excess.

Jacket Removal Calculation Table - Concentric Neutral (CN) Cable - Crimp Type (Compression) Lugs / Connectors - 7652-S-4, 7652-S-4(L), 7653-S-4, 7654-S-4, 7655-S-4, 7655-S-4(L), 7656-S-4			
CABLE PREPARATION ITEM	Inches -Add this column-	mm -Add this column-	NOTES
Insulation Length	8.75"	222 mm	Value from Figure 7
Insulation Removal Length = Depth of Crimp Type (Compression) Terminal Lug or Connector Barrel (See NOTES column.)	+	+	Measure full depth of bore for lugs and to the center stop for connectors.
Growth Allowance (Aluminum Only) for Crimp Type (Compression) Lug / Connector (See NOTES column.)	+	+	See Table 6 for correct growth allowance. This measurement applies only to Aluminum lugs / connectors.
TOTAL JACKET REMOVAL LENGTH	=	=	

Table 7

Jacket Removal Calculation Table - Concentric Neutral (CN) Cable - 3M™ Mechanical Shearbolt Lugs QL2 Series / 3M™ Mechanical Shearbolt Connector QCI Series/ 3M™ Shearbolt Stem Connector QP 7-4/ 0- 7652-S-4(L), 7653-S-4, 7654-S-4, 7655-S-4, 7655-S-4(L), 7656-S-4			
CABLE PREPARATION ITEM	Inches -Add this column-	mm -Add this column-	NOTES
Insulation Length	8.75"	222 mm	Value from Figure 7
Insulation Removal Length = Depth of 3M Mechanical Shearbolt QL2 Series Terminal Lug, Stem Connector QP 7-4/0 or QCI Series Connector Barrel (See NOTES column.)	+	+	Obtain Insulation Removal Length: For 3M Mechanical Shearbolt Lugs or 3M Shearbolt Stem Connector see 3M™ Mechanical Shearbolt Lugs QL2 Series: Two Hole or 3M™ Shearbolt Stem Connector QP 7-4/0 Instructions. For 3M Mechanical Shearbolt Connectors see 3M™ Mechanical Shearbolt Connectors QCI Series Instructions.
TOTAL JACKET REMOVAL LENGTH	=	=	

Table 8

6.7 Bend neutral wires back over applied sealing mastic and secure to cable 4 1/2" (114 mm) from cable semi-con edge using vinyl tape (see NOTE and Figure 8).

NOTE: Position vinyl tape with care, it also serves as a marker for positioning the termination.

6.8 Select second Scotch® Mastic Strip 2230 from kit and remove white release liners. Apply a second **SINGLE WRAP** of mastic over the neutral wires and previously applied mastic (Figure 8). Cut off excess.

6.9 Compress neutral wires into mastic by over-wrapping seal strips with two highly stretched layers of electrical grade vinyl tape (Figure 8). **Be sure to cover all exposed mastic.**

NOTE: DO NOT completely cover the neutral wires with electrical grade vinyl tape when applying over the Scotch® Mastic Strip 2230 per Step 6.9. LEAVE AT LEAST 1" (25 MM) OF EXPOSED NEUTRAL WIRES between the Vinyl Tape Marker applied in step 6.7 and the start of the two half-lapped layers of electrical grade vinyl tape covering the Scotch® Mastic Strip 2230 applied in Step 6.9

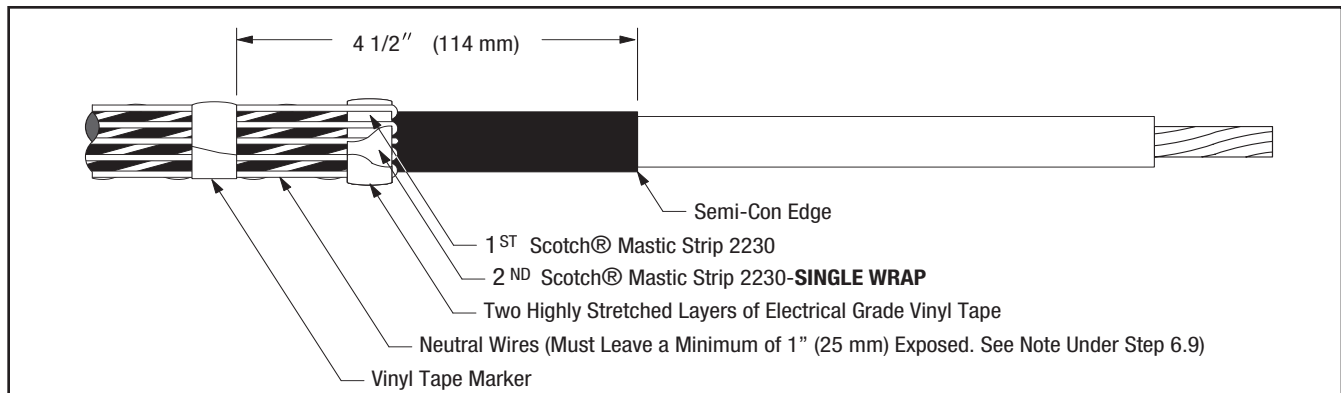

Figure 8

7.0 Install Lug or Connector

Important Packaging Notice

In order to make sure that you receive an undamaged termination, this 3M Cold Shrink QT-III Silicone Rubber Termination is packed with a RED SHIPPING CORE inside of the white core. Please remove the red shipping core BEFORE you install the termination. This shipping core can be recycled with other polypropylene waste.

- 7.1 Check to insure 3M Cold Shrink QT-III Silicone Rubber Termination assembly fits over the selected lug or connector BEFORE installing the lug or connector. If lug or connector (Figure 9) will not fit through the termination core, clean the insulation (per Step 8.0) and slide termination on cable before installing Lug or Connector. **DO NOT REMOVE CORE AT THIS TIME.**

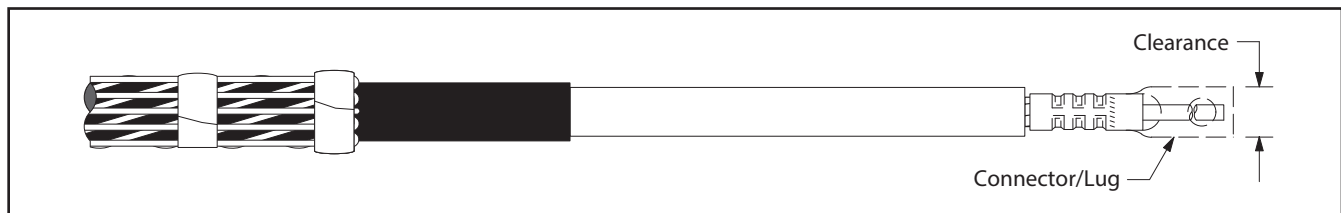

Figure 9

- 7.2 For 3M Compression Lugs and 3M Stem Connectors:
- Refer to pages 12 - 14 for 3M Connector and Lug crimping information.
 - For Aluminum Conductors - Thoroughly wire brush conductor strands to remove aluminum oxide layer. Insert conductor into lug or connector and then remove conductor. This will transfer some of the antioxidant paste onto the conductor. Wire brush the antioxidant paste into the strands. Immediately insert conductor into lug or connector barrel as far as it will go.

NOTE: Die/crimper head rotation between consecutive crimps is RECOMMENDED

- Position connector or lug and crimp according to manufacturer's directions. Remove excess oxide inhibitor and sharp crimp flashings following crimping.
- 7.3 For 3M Mechanical Shearbolt Lugs QL2 Series: Two Hole, 3M Shearbolt Stem Connector QP 7-4/0 or 3M Mechanical Shearbolt Connector QCI Series:
- Refer to the Instructions that are packed with the 3M Shearbolt product for the installation procedures.

8.0 Clean Cable Insulation and Lug or Connector Barrel Using Standard Practice

- 8.1 If abrasive must be used:
- Use on insulation only. **DO NOT USE ABRASIVE ON SEMI-CON INSULATION SHIELD!**
 - Use **ONLY aluminum oxide abrasive**; grit 120 or finer.
 - Be careful not to reduce the cable insulation diameter below that allowed by the kit.
- 8.2 Wipe the cable insulation, and lug or connector, with an approved cable cleaner/solvent (such as 3M Cable Cleaning Solvent CC Series) **AND ALLOW IT TO DRY BEFORE INSTALLING TERMINATION. A clean lint-free cloth, inexpensive paper towel or 3M Cable Cleaning Pads CC-DRY (not supplied with kit) can be used to dry the insulation surface if air drying time is of concern. DO NOT ALLOW SOLVENT TO TOUCH SEMI-CON INSULATION SHIELD!**

9.0 Install Termination

9.1 Slide the termination body onto the cable and remove core. Make sure the termination body (not the core) is butted up to the edge of the vinyl tape marker previously applied (Figure 10). Pull the core while unwinding, counterclockwise, starting with the loose end (Figure 10). Be sure to alternate the pulling and unwinding actions (pull-unwind-pull-unwind-etc.) to help prevent the core material from binding up as the core is being removed (Figure 10).

NOTE: Once the termination body makes contact over the mastic seal area, there is no need to continue supporting the assembly. DO NOT PUSH OR PULL ON THE TERMINATION ASSEMBLY WHILE UNWINDING THE CORE.

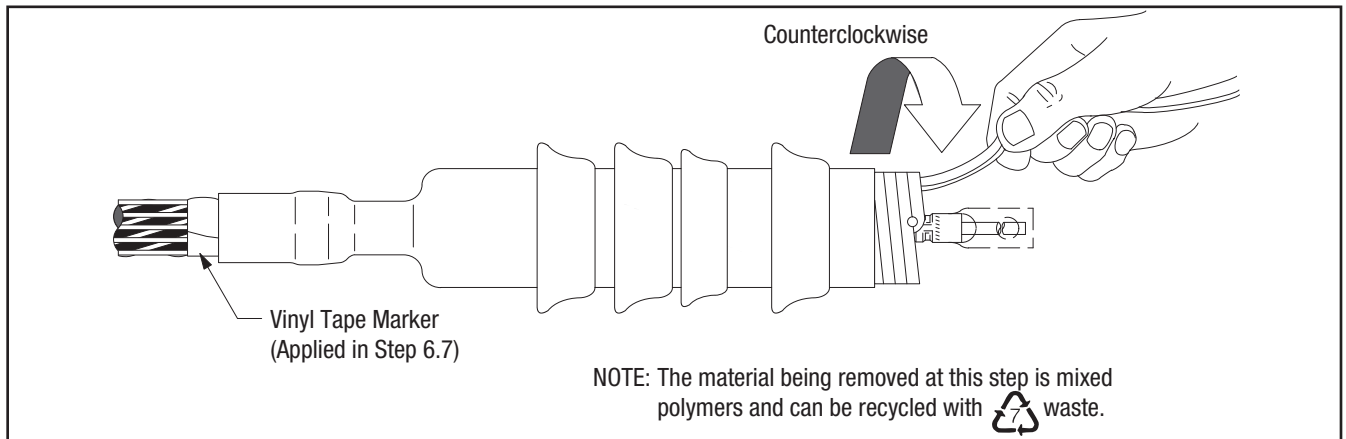

Figure 10

9.2 Collect all concentric neutral wires together (Figure 11) and connect to system ground according to standard practice.

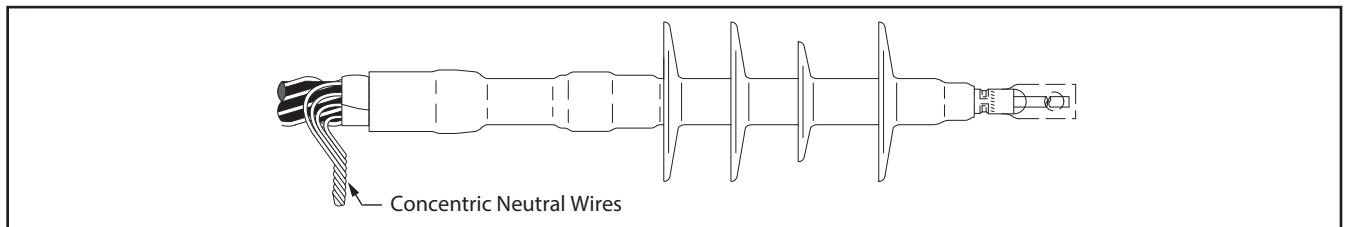
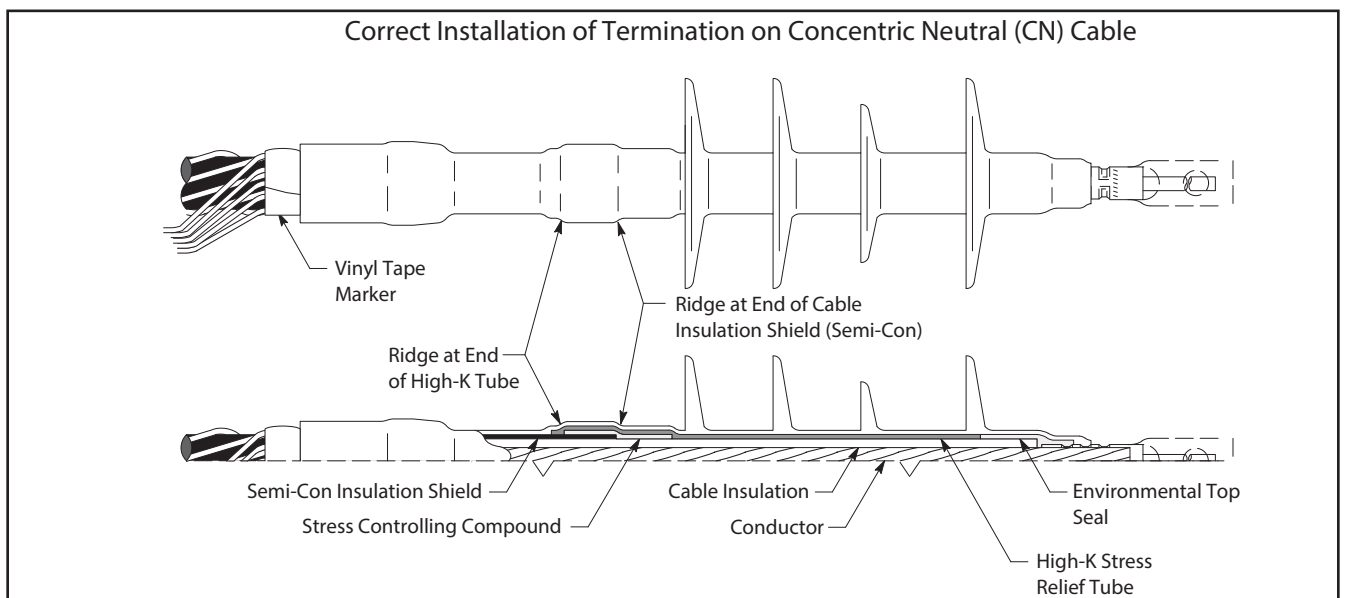

Figure 11



Tooling Index

Lug and Crimping Information for 3M™ Scotchluk™ Copper Lugs										
30014 thru 30045 One hole			31036 thru 31068 One hole-long barrel				31145 thru 31178 Two hole-long barrel			
Crimping Tool-Die Sets (Minimum Number Of Crimps)										
Cable Size AWG/ kcmil	Stud Size (in.)	3M™ Scotchluk™ Copper Lug Number	Burdny Corporation				Thomas & Betts Corporation			Square D Co. Anderson Div.
			MD6	MY29	Y34A	Y35, Y39, Y45*, Y46*	TBM 5	TBM 8	TBM 15	VC6-3, VC6-FT**
6	10 1/4 5/16	30014 30015 30016	-	6AWG(1)	-	U5CRT(1)	Blue(1)	Blue(1)	-	(1)
4	10 1/4 3/8	30018 30019 30021	W161(1)	4AWG(1)	A4CR(1)	U4CRT(1)	Grey(1)	Grey(1)	-	(1)
2	1/4 5/16 3/8	30022 30023 30024	W162(2)	2AWG(1)	A2CR(1)	U2CRT(2)	Brown(1)	Brown(1)	33(1)	(1)
1	5/16 3/8	30027 30028	-	1AWG(1)	A1CR(1)	U1CRT(2)	Green(1)	Green(1)	37(1)	(1)
1/0	5/16 3/8	30031 30032	W163(2)	1/0(1)	A25R(1)	U25RT(1)	Pink(2)	Pink(2)	42H(2)	(1)
2/0	3/8 3/8	30036 31036	W241(2) W241(3)	2/0(1) 2/0(2)	A26R(1) A26R(2)	U26RT(2)	Black(2) Black(3)	Black(2) Black(3)	45(1) 45(2)	(1)
3/0	1/2 1/2	30041 31041	W243(2) W243(3)	3/0(1) 3/0(2)	A27R(1) A27R(2)	U27RT(2)	Orange(2) Orange(3)	Orange(2) Orange(3)	50(1) 50(2)	(1)
4/0	1/2 1/2 1/2	30045 31045 31145	BG(3) BG(4) BG(4)	4/0(1) 4/0(2) 4/0(2)	A28R(2)	U28RT(2)	Purple(2) Purple(3) Purple(3)	Purple(2) Purple(3) Purple(3)	54H(2) 54H(3) 54H(3)	(1)
250	1/2 1/2	31049 31149	W166(4)	250(2)	A29R(2)	U29RT(2)	Yellow(2)	Yellow(2)	62(2)	(2)
300	1/2 1/2	31053 31153	-	-	A30R(2)	U30RT(3)	-	White(3)	66(3)	(2)
350	1/2 1/2	31056 31156	-	-	A31R(2)	U31RT(3)	-	Red(4)	71H(4)	-
400	1/2 1/2	31060 31160	-	-	A32R(2)	U32RT(3)	-	Blue(4)	76H(4)	-
500	1/2 5/8 1/2	31066 31067 31166	-	-	A34R(2)	U34RT(3)	-	Brown(4)	87H(4)	-
600	1/2 1/2	31068 31168	-	-	-	U36RT(3)	-	Green(4)	94H(4)	-
750	1/2	31172	-	-	-	Y39, Y45, Y46 U39RT(5)	-	-	106H(4)	-
1000	1/2	31178	-	-	-	Y45: S44RT(6) Y46: P44RT(6)	-	-	125H(4)	-

* Y45 and Y46 accept all Y35 dies ("U" series). For Y45 use PT6515 adapter. For Y46 use PUADP adapter.

** Anderson VC6-3 and VC6-FT require no die set.

Tooling Index

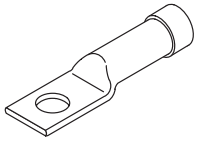
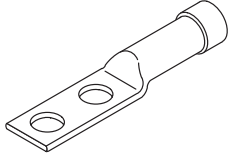
Lug and Crimping Information for 3M™ Scotchlok™ Copper/Aluminum Lugs															
40016 thru 40079 One hole								40132 thru 40178 Two hole							
Cable Size AWG/ kcmil	Stud Size (in.)	3M™ Scotchlok™ Lug Number	Crimping Tool-Die Sets (Minimum Number Of Crimps)												
			Burdny Corporation					Thomas & Betts Corporation				Square D Co. Anderson Div.		ITT Blackburn Co.	Kearny Nat'l Div.
			MD6	MY29	Y34A	Y35, Y39, Y45*, Y46*	Y1000**	TBM 5	TBM 8	TBM 12	TBM 15	VC6-3** VC6-FT**	VC8C**	OD58	TYPE 0
6	5/16	40016	W161(1)	6AWG(1)	A6CAB(1)	U6CABT(1)	(1)	Grey(1)	Grey(1)	-	29(1)	(1)	-	BY19(3)	J(3)
4	5/16	40020	W162(3)	4AWG(1)	A4CAB(1)	U4CABT(1)	(1)	Green(2)	Green(2)	-	37(1)	(1)	-	BY53(3)	P(3)
2	3/8	40024	W163(3)	2AWG(1)	A2CAB(1)	U2CABT(1)	(1)	Pink(2)	Pink(2)	-	42H(2)	(1)	-	BY23(3)	1/2(3)
	1/2	40025	W163(3)	2AWG(1)	A2CAB(1)	U2CABT(1)	(1)	Pink(2)	Pink(2)	-	42H(2)	(1)	-	BY23(3)	1/2(3)
1	3/8	40028	W163(3)	1AWG(1)	A1CAR(1)	U1CART(1)	(1)	Gold(2)	Gold(2)	-	45(1)	(1)	-	BY23(3)	1/2(3)
	1/2	40029	W163(3)	1AWG(1)	A1CAR(1)	U1CART(1)	(1)	Gold(2)	Gold(2)	-	45(1)	(1)	-	BY23(3)	1/2(3)
1/0	3/8	40032	W241(3)	1/0(1)	A25AR(1)	U25ART(1)	(1)	Tan(2)	Tan(2)	-	50(1)	(1)	-	BY25(3)	5/8-1(3)
	1/2	40033	W241(3)	1/0(1)	A25AR(1)	U25ART(1)	(1)	Tan(2)	Tan(2)	-	50(1)	(1)	-	BY25(3)	5/8-1(3)
	3/8	40132	W241(3)	1/0(1)	A25AR(1)	U25ART(1)	(1)	Tan(2)	Tan(2)	-	50(1)	(1)	-	BY25(3)	5/8-1(3)
2/0	1/2	40037	BG(4)	2/0(1)	A26AR(2)	U26ART(2)	(1)	Olive(2)	Olive(2)	-	54H(2)	(2)	-	BY31C(3)	5/8-1(3)
	1/2	40137	BG(4)	2/0(1)	A26AR(2)	U26ART(2)	(1)	Olive(2)	Olive(2)	-	54H(2)	(2)	-	BY31C(3)	5/8-1(3)
3/0	1/2	40041	W166(4)	3/0(1)	A27AR(2)	U27ART(2)	(1)	Ruby(2)	Ruby(2)	-	60(2)	(2)	-	-	737(3)
	1/2	40141	W166(4)	3/0(1)	A27AR(2)	U27ART(2)	(1)	Ruby(2)	Ruby(2)	-	60(2)	(2)	-	-	737(3)
4/0	1/2	40045	W660(4)	4/0 (2)	A28AR(2)	U28ART(2)	(1)	-	White(4)	-	66(4)	(2)	-	BY35C(4)	840(4)
	5/8	40046	W660(4)	4/0 (2)	A28AR(2)	U28ART(2)	(1)	-	White(4)	-	66(4)	(2)	-	BY35C(4)	840(4)
	1/2	40145	W660(4)	4/0 (2)	A28AR(2)	U28ART(2)	(1)	-	White(4)	-	66(4)	(2)	-	BY35C(4)	840(4)
250	1/2	40049	W249(3)	-	A29AR(2)	U29ART(2)	(1)	-	-	71H(4)	71H(2)	(3)	-	-	-
	5/8	40050	W249(3)	-	A29AR(2)	U29ART(2)	(1)	-	-	71H(4)	71H(2)	(3)	-	-	-
	1/2	40149	W249(3)	-	A29AR(2)	U29ART(2)	(1)	-	-	71H(4)	71H(2)	(3)	-	-	-
300	1/2	40053	-	-	A30AR(2)	U30ART(2)	(1)	-	-	76H(4)	76H(2)	(3)	-	-	-
	1/2	40153	-	-	A30AR(2)	U30ART(2)	(1)	-	-	76H(4)	76H(2)	(3)	-	-	-
350	1/2	40056	-	-	-	U31ART(2)	(1)	-	-	87H(4)	87H(3)	(3)	-	-	-
	5/8	40057	-	-	-	U31ART(2)	(1)	-	-	87H(4)	87H(3)	(3)	-	-	-
	1/2	40156	-	-	-	U31ART(2)	(1)	-	-	87H(4)	87H(3)	(3)	-	-	-
400	1/2	40160	-	-	-	U32ART(4)	(1)	-	-	94H(4)	94H(4)	-	(2)	-	-
500	5/8	40067	-	-	-	U34ART(4)	(1)	-	-	106H(4)	106H(3)	-	(2)	-	-
	1/2	40166	-	-	-	U34ART(4)	(1)	-	-	106H(4)	106H(3)	-	(2)	-	-
600	1/2	40170	-	-	-	U36ART(4)	(1)	-	-	-	115H(3)	-	(3)	-	-
750	5/8	40073	-	-	-	U39ART(4)	(1)	-	-	-	125H(4)	-	(3)	-	-
	1/2	40172	-	-	-	U39ART(4)	(1)	-	-	-	125H(4)	-	(3)	-	-
1000	5/8	40079	-	-	-	S44ART(4)	(1)	-	-	-	140H(4)	-	(3)	-	-
	1/2	40178	-	-	-	S44ART(4)	(1)	-	-	-	140H(4)	-	(3)	-	-

* Y45 and Y46 accept all Y35 dies ("U" series). For Y45 use PT6515 adapter. For Y46 use PUADP adapter.

** Anderson VC6-3, VC6-FT, VC8C and Burndy Y1000 require no die set.

Tooling Index

Conductor Size AWG & kcmil		3M™ Connector Number	Crimping Table For 3M™ Stem Type Connector				
Stranded	Solid		Recommended Crimping Tools				
			Manufacturer	Mech. Tool	Die (Minimum No. Crimps)	Hydraulic	Die (Minimum No. Crimps)
2, 1 4 1/0	1, 1/0 2 2/0	SC0001 SC0002 SC0010	Burndy	MD6	BG(4), W241(3)	Y35, Y39, Y45*, Y46*	U25ART(2), U243(2)
			Kearny	0-51, 0-52	5/8-1 (4)	WH-1, WH-2	5/8-1(4)
			T & B	TBM 5	Tan(2)	-	-
			T & B	TBM 8	Olive(2), Tan(2)	TBM 15	50(2)
			Anderson	-	-	VC6**	(2)
2/0 3/0 4/0	3/0 4/0 -	SC0020 SC0030 SC0040	Burndy	MD6	W249(3)	Y35, Y39, Y45*, Y46*	U28ART(2)
			Kearny	0-51, 0-52	840(5)	WH-1, WH-2	840(2)
			T & B	TBM 8	Red(4)	TBM 15	71H(3)
			Anderson	-	-	VC6**	(2)

* Y45 and Y46 accept all Y35 dies ("U" series). For Y45 use PT6515 adapter. For Y46 use PUADP adapter.

** Anderson VC6 is dieless and does not require a die set.

3M, Scotch and Scotchlok are trademarks of 3M Company.

Important Notice

All statements, technical information, and recommendations related to 3M's products are based on information believed to be reliable, but the accuracy or completeness is not guaranteed. Before using this product, you must evaluate it and determine if it is suitable for your intended application. You assume all risks and liability associated with such use. Any statements related to the product which are not contained in 3M's current publications, or any contrary statements contained on your purchase order shall have no force or effect unless expressly agreed upon, in writing, by an authorized officer of 3M.

Warranty; Limited Remedy; Limited Liability.

This product will be free from defects in material and manufacture at the time of purchase. **3M MAKES NO OTHER WARRANTIES INCLUDING, BUT NOT LIMITED TO, ANY IMPLIED WARRANTY OF MERCHANTABILITY OR FITNESS FOR A PARTICULAR PURPOSE.** If this product is defective within the warranty period stated above, your exclusive remedy shall be, at 3M's option, to replace or repair the 3M product or refund the purchase price of the 3M product. **Except where prohibited by law, 3M will not be liable for any direct, indirect, special, incidental or consequential loss or damage arising from this 3M product, regardless of the legal theory asserted.**



Electrical Markets Division
13011 McCallen Pass, Bldg. C
Austin, TX 78753 USA

Phone 1-800-245-3573
Web www.3M.com/electrical

Please Recycle. Printed in USA.
© 3M 2021. All Rights Reserved.
78-8117-0588-4 Rev J