

Project: _____ Type: _____

Drawn by: _____ Catalogue #: _____ Date: _____

Individual Spec Sheet

MOUNTING PLATE

WITH HANGER BARS

Downlight Accessory

ORDERING INFORMATION

Order code: 66819
Model number: ACC/MPLATE/2.75IN/HANG.BARS/STD
UPC: 069549668195
Case quantity: 25

PHYSICAL DATA

Type: Mounting plate with hanger bars
Material: Steel
Length in. (mm): 8 1/16 (205)
Width in. (mm): 5 1/4 (133.5)
Height in. (mm): 1/4 (7.19)
Opening diameter in. (mm): 2 3/4 (70)

DIMENSIONS

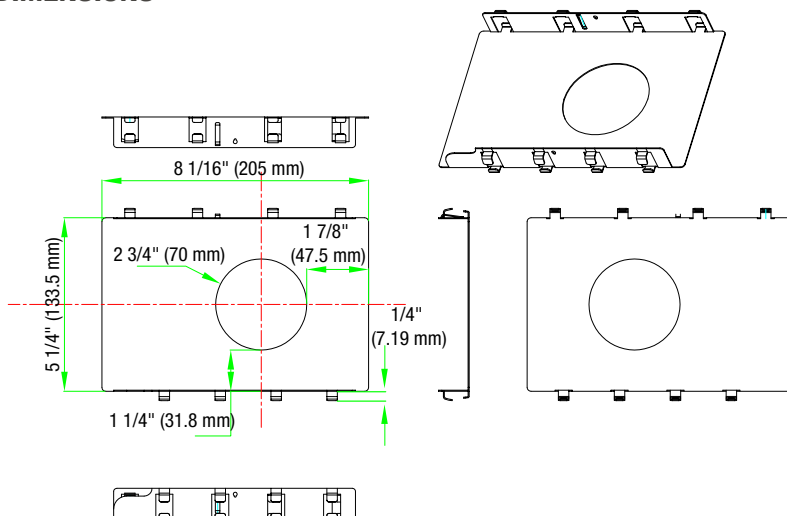

Qty	Description	Price

I accept the specifications of the luminaire configuration mentioned above.

Name: _____

Company: _____

Signature: _____

Date: _____

Data is based upon tests performed in a controlled environment. Actual performance can vary depending on operating conditions.
 All products are subject to change or may be discontinued any time without notice.