



# Selective Call Intercom

## SYSTEM INSTALLATION GUIDE

1308003 REV.B



301 Fulling Mill Road, Suite G  
Middletown, PA 17057  
(800)-321-2343

©Copyright 2008 by On-Q/Legrand,  
Inc All Rights Reserved.  
[www.onqlegrand.com](http://www.onqlegrand.com)

## Federal Communications Commission Statement

This device complies with Part 15 of the FCC Rules. Operation is subject to the following two conditions:

- This device may not cause harmful interference, and
- This device must accept any interference received, including interference that may cause undesired operation.

This equipment has been tested and found to comply with the limits for a class B digital device, pursuant to Part 15 of the Federal Communications Commission (FCC) rules. These limits are designed to provide reasonable protection against harmful interference in a residential installation. This equipment generates, uses, and can radiate radio frequency energy and, if not installed and used in accordance with the instructions, may cause harmful interference to radio communications. However, there is no guarantee that interference will not occur in a particular installation. If this equipment does cause harmful interference to radio or television reception, which can be determined by turning the equipment off and on, the user is encouraged to try to correct the interference by one or more of the following measures:

- Reorient or relocate the receiving antenna.
- Increase the separation between the equipment and receiver.
- Connect the equipment into an outlet on a circuit different from that to which the receiver is connected.
- Consult the dealer or an experienced radio/TV technician for help.

Reprinted from the Code of Federal Regulations #47, part 15.193, 1993. Washington DC: Office of the Federal Register, National Archives and Records Administration, U.S. Government Printing Office.

**WARNING: TO PREVENT FIRE OR SHOCK HAZARD, DO NOT EXPOSE THIS PRODUCT TO RAIN OR MOISTURE. THE UNIT MUST NOT BE EXPOSED TO DRIPPING OR SPLASHING WATER.**

**CAUTION: DO NOT OPEN THE UNIT. DO NOT PERFORM ANY SERVICING OTHER THAN THAT CONTAINED IN THE INSTALLATION AND TROUBLESHOOTING INSTRUCTIONS. REFER ALL SERVICING TO QUALIFIED SERVICE PERSONNEL.**

**CAUTION: THIS DEVICE MUST BE INSTALLED AND USED IN STRICT ACCORDANCE WITH THE MANUFACTURER'S INSTRUCTIONS AS DESCRIBED IN THE USER DOCUMENTATION THAT COMES WITH THE PRODUCT.**

**WARNING: POSTPONE INSTALLATION UNTIL THERE IS NO RISK OF THUNDERSTORM OR LIGHTNING ACTIVITY IN THE AREA.**

*When using this device, basic safety precautions should always be followed to reduce the risk of fire, electric shock and injury to persons, including the following:*

- Read all of the instructions {listed here and/or in the user manual} before you operate this equipment.
- Give particular attention to all safety precautions.
- Retain the instructions for future reference.
- Comply with all warning and caution statements in the instructions.
- Observe all warning and caution symbols that are affixed to this equipment.
- Comply with all instructions that accompany this equipment.
- Avoid using this product during an electrical storm. There may be a risk of electric shock from lightning. It is recommended that the customer install an AC surge protector in the AC outlet to which this device is connected. This is to avoid damaging the equipment by local lightning strikes and other electrical surges.
- Operate this product only from the type of power source indicated on the product's marking label.
- If you are not sure of the type of power supplied to your home, consult your dealer or local power company.
- Upon completion of any service or repairs to this product, ask the service technician to perform safety checks to determine that the product is in safe operating condition.

Installation of this product must be in accordance with national wiring codes and conform to local regulations.

Wipe the unit with a clean, dry cloth. Never use cleaning fluid or similar chemicals. Do not spray cleaners directly on the unit or use forced air to remove dust.

Keep the device away from excessive heat and humidity and keep the device free from vibration and dust.



301 Fulling Mill Road, Suite G  
Middletown, PA 17057  
(800)-321-2343

©Copyright 2008 by On-Q/Legrand,  
Inc All Rights Reserved.  
www.onqlegrand.com

# TABLE OF CONTENTS

<b>I. Introduction</b>	<b>1</b>
A. Installation Safety Precautions	1
<b>II. System Components Overview</b>	<b>2</b>
A. System Components	2
<b>III. Wiring Specifications</b>	<b>3</b>
A. Specifications	3
B. Guidelines	3
C. Unit Placement	3
D. Termination Instructions	3
<b>IV. System Wiring Overview</b>	<b>4</b>
A. Pre-Wiring (Rough-In)	4
B. Final Wiring (Trim-Out)	7
<b>V. System Configuration</b>	<b>12</b>
A. Choosing Unit Names	12
B. Modifying Reply Options	13
C. Room Options	13
D. Door Options	14
E. Patio Options	15
F. Installer Setup	15
<b>VI. Troubleshooting</b>	<b>20</b>
A. Contact Information	20
B. Troubleshooting Guide	20
C. Warranty	21
<b>VII. Installer Checklist</b>	<b>22</b>



301 Fulling Mill Road, Suite G  
Middletown, PA 17057  
(800)-321-2343

©Copyright 2008 by On-Q/Legrand,  
Inc All Rights Reserved.  
[www.onqlegrand.com](http://www.onqlegrand.com)

## I. Installation Introduction

The On-Q/Legrand Selective Call Intercom System is an advanced Cat 5 based intercom system consisting of 2-gang Room Units, Patio Units and Door Units. Each of these user stations are connected with a single Cat 5 cable to an Intercom Module in the enclosure. The Room Units contain an intuitive graphical user interface in the form of a liquid crystal display, similar to today's cell phones. Communication may occur in a broadcast fashion if desired, or to specific units as selected on the Room Unit LCD.

Installation of the system is simplistic due to the fact that all units are connected with a single Cat 5 cable and all units are the same small physical size. The firmware that runs on the system controller discovers each unit by type and keeps track of them. If a unit becomes disabled, it is removed from the system list and does not affect the other units. In fact, replacement is as simple as unplugging the old unit and plugging in the new unit, which will be automatically discovered and added to the list.

The robust system software allows you to install the system and utilize the defaults, for a quick and simple installation, or add value by customizing and personalizing the installation. The system can be personalized, choosing what to call each user station from a list of over 90 names. The door tone can be personalized for each door unit, choosing from 20 different high quality door tones.

### A. Installation Safety Precautions

**NOTE: Read all instructions carefully and completely before installing the On-Q/Legrand Selective Call Intercom System.**

Throughout the following safety precautions and instructions the term "component" will be used to indicate one or all of the following: Intercom Module, Room Unit, Patio Unit, or Door Unit.

- These installation instructions were designed for use by an authorized On-Q installer only. Do not attempt to service, move, or change any component of this system unless you are qualified to do so.
- This system must be installed to conform to all local building and electrical codes.
- **Do not** apply power to the Intercom Module until all Selective Call Intercom System components have been installed and all wiring has been properly terminated.
- Although the SCI System Units are hot swappable, it is good practice to first turn off power at the Intercom Module in the On-Q enclosure prior to terminating, changing, or un-installing any wiring. Unplug the power transformer that is powering the Intercom Module from the power outlet before proceeding with wiring terminations or changes.
- Install each component of this system **away** from heat sources such as heating ducts/registers, stoves, or any other heat source.
- **Do not** install any component in a return air duct.
- The Selective Call Intercom Module and any other component module were designed to be installed into an On-Q/Legrand enclosure. This enclosure must be installed in a cool dry area and must be installed according to its installation instructions. Do not install an On-Q enclosure or any On-Q module or device in an unheated garage, attic, or outside wall.
- **Do not** expose any Selective Call Intercom System component that was designed for indoor use to moisture. Doing so can create electrical hazards or render the component unusable. Exposure to moisture will also void the warranty on the system.
- **Only use** On-Q/Legrand authorized components, modules, and devices with the Selective Call Intercom System. Not doing so will void the warranty of the system.
- **Only use** a damp cloth to clean the cover plates of the system components.
- **Do not** use vacuum cleaners, liquid or aerosol cleaners to clean any of the system components.



301 Fulling Mill Road, Suite G  
Middletown, PA 17057  
(800)-321-2343

©Copyright 2008 by On-Q/Legrand,  
Inc All Rights Reserved.  
[www.onqlegrand.com](http://www.onqlegrand.com)

## II. System Components Overview

### A. System Components

The following components (in addition to the 24VDC 1.25A 30 watt power supply) are typically utilized to make up the Selective Call Intercom System (see **Figure 1**).

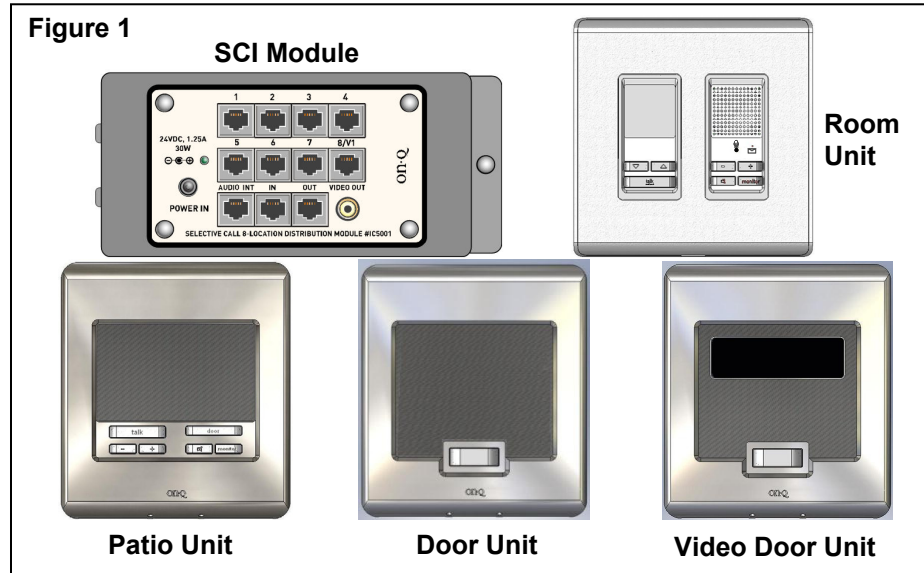

- **Selective Call Intercom Distribution Module/s:** These modules are typically installed in the On-Q enclosure. All Room Units, Patio Units and Door Units are connected directly to the Intercom Distribution Module via “home run” style single Cat 5e cabling. The Intercom Distribution Module also supplies power to the entire Selective Call Intercom System. Up to eight Units of any combination are supported by each Distribution Module and Modules may be cascaded three times, for a total system support of up to 32 Units.
- **Selective Call Room Unit:** Using the intuitive graphical user interface of its LCD display, this unit provides both basic intercom communication functions such as talk, talk to door (if Door Unit is installed), monitor and mute, and advanced functions such as dynamic sorting of users or monitoring multiple rooms at the same time. Up to 8 Selective Call Room Units can be installed per Selective Call Intercom Distribution Module and up to 32 per system.
- **Selective Call Patio Unit:** This unit also provides typical basic Room Unit functionality in a weather resistant wall mounted package for your patio. For security reasons, it does not support the door release function. There are no specific limits as to the mix of Room Units and Patio Units up to the physical limit of 8 per Distribution Module and 32 per system.
- **Selective Call Door/Video Door Unit:** This unit allows a visitor to the home to press the door chime button on the unit to notify the occupants of their presence. The occupants can then initiate a two-way communication with the visitor, see the visitor (Video Door Unit only) and even open the door (requires electronic door release device, not included). Up to 20 different door tones can be selected as the door tone that is played when the door chime button is pressed. There are no limits to the mix of Room, Patio and Door Units up to the physical limit of 8 per Distribution Module and 32 per system.

### III. Wiring Specifications

#### A. Specifications

Minimum cable rating: Category 5e UTP, 4 pair solid conductors (24 AWG), 100 ohm, 100 Mhz, General Purpose (CM), UL listed Maximum length per run: 325 feet (except where noted in documentation)

Termination standard: T568A

Terminating plug type: Solid Conductor RJ45

#### B. Guidelines

- Do not exceed 25 lbs. of force when pulling cable.
- Do not splice cables.
- Do not staple cables. Use wire ties with screw mounts to loosely secure cabling.
- Avoid running Cat 5 cable parallel to 120V/240V AC wiring or fixtures within 12 inches.
- Avoid “ganging” any intercom unit with a lighting dimmer switch. Maintain at least 12 inches of separation from dimmer switches.
- If you must cross AC wiring, do so at a 90 degree angle with at least 2 inches of separation.
- Maintain a minimum 1” bend radius.
- Do not untwist Cat 5 conductors more than 1/2” at any termination point.
- Keep cables away from HVAC ducts, or anything with sharp edges that could cause damage.
- Clearly label all cabling runs at both ends. Use the distance between your hand and your elbow as a guide to determine how far from the end of the cable to place the label.

#### C. Unit Placement

To provide optimal display quality of the LCD on the Selective Call Room Unit, the two gang box that it is mounted in should be located for eye level operation. The bottom of the two gang box should be approximately 56” from the floor see **Figure 2**.

Carefully plan the placement of Room Units before rough-in to avoid any feedback issues that are associated with audio devices.

- Avoid placing units back to back on a common wall to minimize the likelihood of any feedback issues. If units must be placed on both sides of a common wall, then place insulation in the back cavity of each electrical box.
- Do not place intercom units within the same room in the home.
- Avoid any situations where the speaker of a unit points to and has a clear line of sight to another unit's microphone.

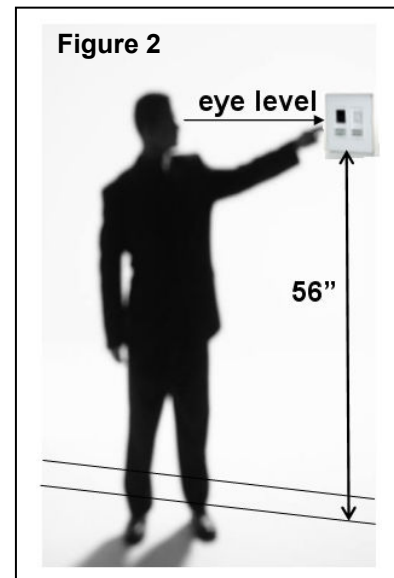

#### D. Termination Instructions

All components of the Selective Call Intercom System use RJ45 plugs terminated to the T568A wiring standard shown in **Figure 3**.

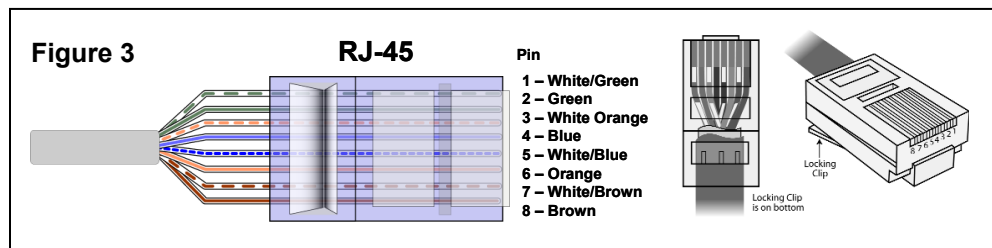

## IV. System Wiring Overview

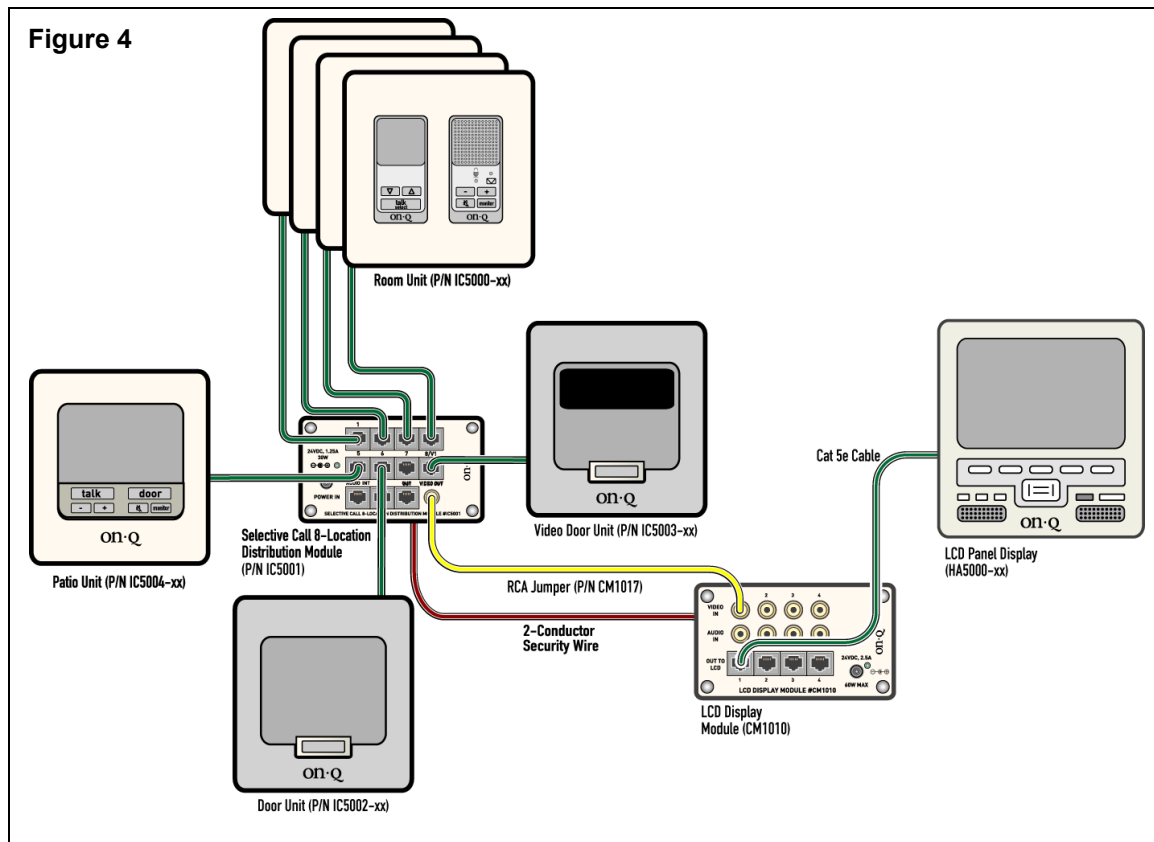

### A. Pre-Wiring (Rough-In)

The rough-in of the Selective Call Intercom System should be completed during the construction phase of the home and prior to the installation of drywall. The following section will instruct you on the proper methods to pre-wire your cable and rough-in the openings for the various Selective Call Intercom System components.

#### Selective Call Room Unit(s)

The procedure to rough-in the Selective Call Room Unit(s) is as follows:

- Typically the Room Unit(s) will be installed on the same wall as the door to the room. Verify each Room Unit location with the homeowner before proceeding. Avoid installing Room Units in the same stud cavity on opposite sides of the wall to prevent feedback problems. If Room Units must be mounted back-to-back, place insulation in the back of both electrical boxes.
- The Room Unit mounts in a standard 2 gang electrical box. The use of an enclosed box rather than an open mud ring will help minimize the potential for feedback between units.
- Any UL approved metal or plastic gang box can be used.
- To avoid damage from debris during construction or after construction, use a gang box that will completely enclose the unit.
- To provide optimal display quality of the LCD on the Room Unit, the bottom of the 2 gang box should be installed at a height of 56" (see **Figure 2**).
- **ONE** Cat 5e run is required to operate the Room Unit.
- Run **ONE** Cat 5e cable from the 2 gang box directly to the enclosure where the Intercom Distribution Module will be installed. Label both ends of your cable run to indicate Room Unit number (ex: "Room Unit 5). Follow the wiring guidelines listed in this manual to ensure a quality cable installation.



- Repeat these instructions for each and every Room Unit that will be installed in the system (maximum of 32).

### **Selective Call Patio Unit(s)**

The procedure to rough-in the Patio Unit(s) is as follows:

- Typically the Patio Unit(s) will be installed on the exterior of the home next to a patio door. Verify the Patio Unit(s) location(s) with the homeowner or builder before proceeding.
- Since the Patio Unit will most likely be installed on the exterior of the home and will be exposed to weather conditions, these instructions must be followed to ensure a quality installation.

#### **Brick or other cement-based material exteriors:**

- On-Q offers a 2-gang back box (P/N IC5006-BK) which is matched to the shape of our Patio Unit. The On-Q back box may be used with any typical 2 gang outdoor weatherproof box. This box should be of the type that is made of heavy die-cast aluminum. Using a heavy die-cast aluminum box will provide adequate strength in a brick or cement-based exterior.

#### **Vinyl or wood based siding material exteriors:**

- The On-Q 2-gang back box (P/N IC5006-BK) may also be used for vinyl or wood-based siding installation. It can also be used with a heavy duty die-cast aluminum 2 gang box that is securely mounted to the interior framing. If this is not possible then it may be used with a heavy duty metal 2 gang box that can be securely mounted to the interior framing of the home.
- To ensure the 2 gang box that will be used to house the Patio Unit is roughed in correctly, communication with the building contractor who is responsible for the exterior finish of the home is highly recommended.

#### **Brick or other cement-based material exteriors:**

- The masonry contractor must be provided with specific instructions as to how the 2 gang box should be installed including location, correct positioning, and proper depth.
- If possible, clearly mark this information on the home's exterior insulation board or vapor barrier material to serve as a reminder to the mason.
- The correct positioning of the 2 gang box may not be obvious to the masonry contractor. Ensure that the masonry contractor knows which edge of the box is up so that the Patio Unit can be installed in the correct vertical position.
- The 2 gang box should be installed by the masonry contractor so that it protrudes slightly from the face of the brick.

#### **Vinyl or wood based siding material exteriors:**

- The 2 gang box can be roughed in to the exterior of the home by first cutting an opening through the exterior base material of the home that is slightly larger than your 2 gang box.
- The 2 gang box (with or without our paintable back box) should then be securely mounted to the interior framing of the exterior wall and protrudes through the exterior wall at a depth that will need to be determined based on the type of siding that will finish the outside of the wall.
- Ideally, you would want the siding contractor to use flashing and make use of J-channel around the perimeter of the Patio Unit and 2 gang box to provide an attractive and weatherproof siding installation. Siding contractors should use flashing and J-channel around the perimeter of the Patio Unit just as they would with a window.
- Communication with the siding contractor is highly recommended to ensure a smooth installation.
- **ONE** Cat 5e run is required to operate the Patio Unit.
- Run **ONE** Cat 5e cable from the 2 gang box directly to the enclosure where the Intercom Module will be installed. Label both ends of your cable run to indicate "Patio Unit". Follow the wiring guidelines listed in this manual to ensure a quality cable installation.

**NOTE: The Patio Unit can be connected to any of the 8 ports on the Intercom Distribution Module (labeled 1-8).**



### **Selective Call Door Unit(s)**

The procedure to rough-in the Door Unit(s) is as follows:

- Typically the Door Unit(s) will be installed on the exterior of the home next to an entrance door, where you would normally find a standard doorbell. Verify the Door Unit(s) location(s) with the homeowner or builder before proceeding.
- Since the Door Unit will most likely be installed on the exterior of the home and will be exposed to weather conditions, these instructions must be followed to ensure a quality installation.

#### **Brick or other cement-based material exteriors:**

- On-Q offers a 2-gang back box (P/N IC5006-BK) which is matched to the shape of our Door Unit. The On-Q back box may be used with any typical 2 gang outdoor weatherproof box. This box should be of the type that is made of heavy die-cast aluminum. Using a heavy die-cast aluminum box will provide adequate strength in a brick or cement-based exterior.

#### **Vinyl or wood based siding material exteriors:**

- The On-Q 2-gang back box (P/N IC5006-BK) may also be used for vinyl or wood-based siding installation. It can also be used with a heavy duty die-cast aluminum 2 gang box that is securely mounted to the interior framing. If this is not possible then it may be used with a heavy duty metal 2 gang box that can be securely mounted to the interior framing of the home.
- To ensure the 2 gang box that will be used to house the Door Unit is roughed in correctly, communication with the building contractor who is responsible for the exterior finish of the home is highly recommended.

#### **Brick or other cement-based material exteriors:**

- The masonry contractor must be provided with specific instructions as to how the 2 gang box should be installed including location, correct positioning, and proper depth.
- If possible, clearly mark this information on the home's exterior insulation board or vapor barrier material to serve as a reminder to the mason.
- The correct positioning of the 2 gang box may not be obvious to the masonry contractor. Ensure that the masonry contractor knows which edge of the box is up so that the Door Unit can be installed in the correct vertical position.
- The 2 gang box should be installed by the masonry contractor so that it protrudes slightly from the face of the brick.

#### **Vinyl or wood based siding material exteriors:**

- The 2 gang box can be roughed in to the exterior of the home by first cutting an opening through the exterior base material of the home that is slightly larger than your 2 gang box.
- The 2 gang box (with or without our paintable back box) should then be securely mounted to the interior framing of the exterior wall and protrudes through the exterior wall at a depth that will need to be determined based on the type of siding that will finish the outside of the wall.
- Ideally, you would want the siding contractor to use flashing and make use of J-channel around the perimeter of the Door Unit and 2 gang box to provide an attractive and weatherproof siding installation. Siding contractors should use flashing and J-channel around the perimeter of the Door Unit just as they would with a window.
- Communication with the siding contractor is highly recommended to ensure a smooth installation.
- **ONE** Cat 5e run is required to operate the Door Unit.
- Run **ONE** Cat 5e cable from the 2 gang box directly to the enclosure where the Intercom Module will be installed. Label both ends of your cable run to indicate Door Unit number (ex: "Door Unit 1). Follow the wiring guidelines listed in this manual to ensure a quality cable installation.
- Repeat these instructions for each and every Door Unit that will be installed in the system.

**NOTE: The Door Unit can be connected to any of the 8 ports on the Intercom Distribution Module (labeled 1-8).**



301 Fulling Mill Road, Suite G  
Middletown, PA 17057  
(800)-321-2343

©Copyright 2008 by On-Q/Legrand,  
Inc All Rights Reserved.  
www.onqlegrand.com

### Selective Call Intercom Distribution Module/s

The rough-in of the On-Q Enclosure that will house the Intercom Distribution Module/s will need to be completed per the enclosure's installation instructions. There is no further rough-in work required for the Intercom Distribution Module since this component will mount directly in the On-Q Enclosure during trim-out.

### B. Final Wiring (Trim-Out)

The trim-out of the system should be completed after wall coverings have been finalized. The following section will instruct you on the proper methods to finish the installation of the various Selective Call Intercom System components.

#### Selective Call Room Unit(s)

The procedure to trim-out the Room Unit(s) is as follows:

- Locate a Cat 5e cable in a roughed in 2 gang box labeled as "Room Unit X" (X is the Room Unit number).
- Strip approximately 2" of insulation from the Cat 5e cable.
- Untwist cable pairs and place them next to each other in color-coded order according to the T568A standard and insert the wires into an RJ45 plug.
- Crimp the RJ45 plug onto the cable with a proper RJ45 crimp tool.
- Plug the terminated "Room Unit X" cable into the RJ45 jack on the rear of the Room Unit (see **Figure 5**).
- Insert the Room Unit and the Cat 5e cable into the 2 gang box and secure the unit to the box using the 4 included pan head screws. Screw the wall plate frame to the Room Unit using the 4 provided flat head screws and snap on the supplied Room Unit decorator style wall plate cover to complete the installation.
- Repeat these instructions for all the Room Units in your Selective Call Intercom System.

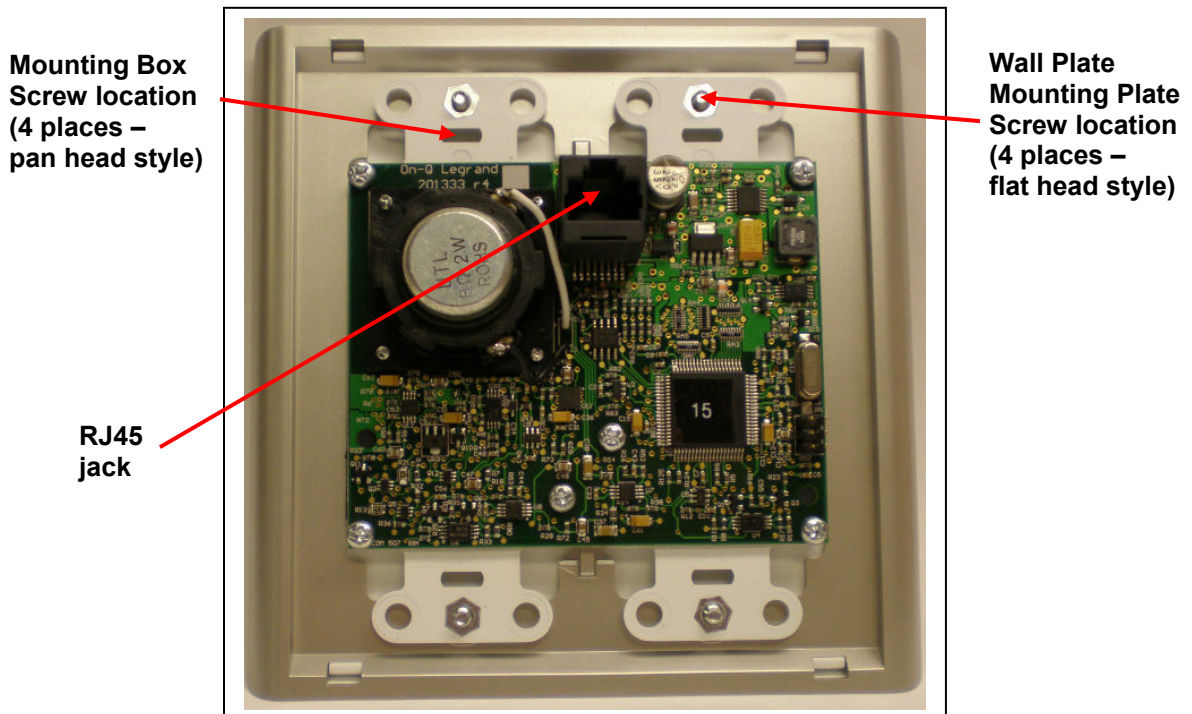

Figure 5

### Selective Call Patio Unit(s)

The procedure to trim-out the Patio Unit(s) is as follows:

- As shown in **Figure 6**, the first step to installing the Selective Call Patio Unit is to place the included weather proofing rear gasket against the gang or back box, and secure the gasket in place with the included mounting bracket.

**NOTE:** Insure that the mounting bracket is installed with the center tab pointed up, as the Patio Unit will be “hung” from this tab in a later step.

**NOTE:** There are slotted holes in the mounting bracket to allow for leveling of the Patio Unit in case the gang or back box was installed off level.

- Use the four provided screws to attach the mounting bracket to the gang or back box.

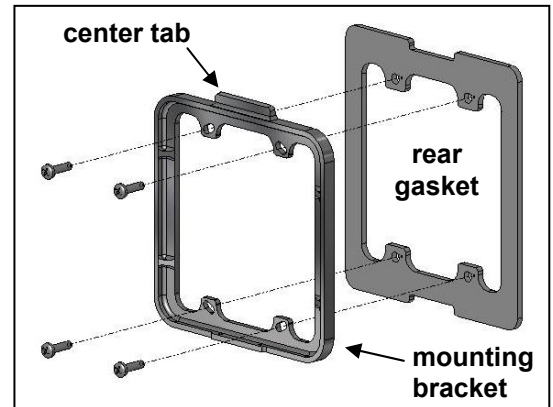

Figure 6

- Pull the Cat 5 cable from the enclosure through the mounting bracket and terminate the cable with an RJ45 plug and insert the plug into the RJ45 jack on the rear of the Patio Unit (see **Figure 7**). Follow the T568A standards described in **Figure 3**.
- Hang the Patio Unit from the top tab on the mounting bracket insuring the front gasket is in place and against the mounting bracket.
- Use the provided 1/16” allen wrench to tighten the two set screws at the bottom of the Patio Unit.

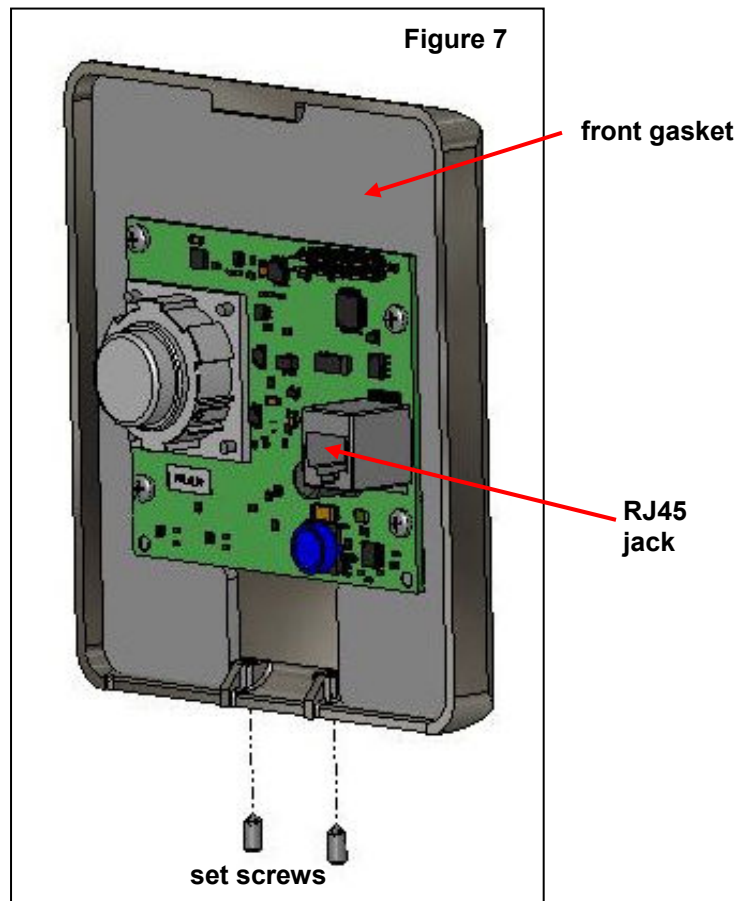

Figure 7

### Selective Call Door Unit(s)

The procedure to trim-out the Door Unit(s) is as follows:

**NOTE:** Make sure that the included weather proofing gasket is placed as shown in *Figure 8*.

- As shown in *Figure 8*, the first step to installing the Selective Call Door Unit is to place the included rear gasket against the gang or back box, and secure the gasket in place with the included mounting bracket.

**NOTE:** Insure that the mounting bracket is installed with the center tab pointed up, as the Door Unit will be “hung” from this tab in a later step.

**NOTE:** There are slotted holes in the mounting bracket to allow for leveling of the Door Unit in case the gang or back box was installed off level.

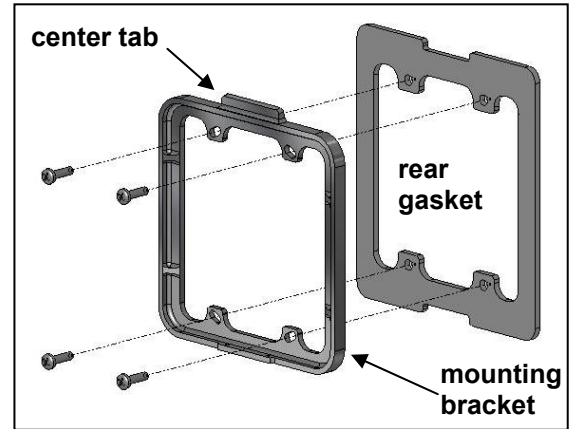

Figure 8

- Use the four provided screws to attach the mounting bracket to the gang or back box.
- Pull the Cat 5 cable from the enclosure through the mounting bracket and terminate the cable with an RJ45 plug and insert the plug into the RJ45 jack on the rear of the Door Unit (see *Figure 9*). Follow the T568A standards described in *Figure 3*.
- Hang the Door Unit from the top tab on the mounting bracket insuring the front gasket is in place and against the mounting bracket.
- Use the provided 1/16” allen wrench to tighten the two set screws at the bottom of the Door Unit.

**NOTE:** There is a four position terminal block on the rear of the Door Unit that can be utilized for two different purposes (see *Figure 10*). The CHIME output is a normally open dry contact closure used to ring a customers 3<sup>rd</sup> party door chime when the Door Unit button is pressed. The SENSOR input is reserved for a future application.



Figure 10

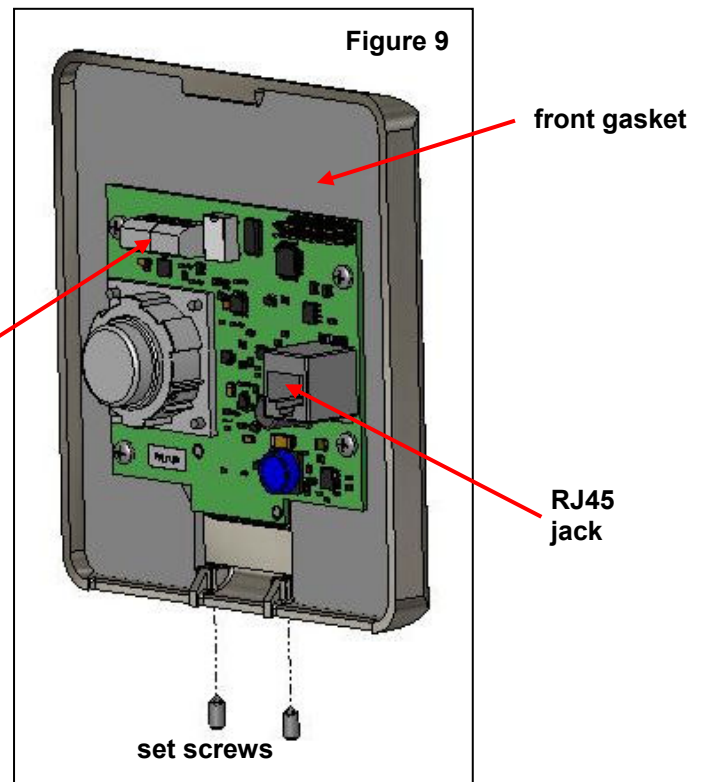

Figure 9

### Selective Call Intercom Distribution Module

The procedure to install the Intercom Distribution Module is as follows:

- As shown in **Figure 11**, there is an “ADDRESS” jumper block located at the top of the rear of the Selective Call Intercom Distribution Module. This jumper block is used to select the Master module, and up to three Slave modules when cascading Distribution Modules. Each Selective Call Distribution Module is shipped with the jumper in the Master position. Use the diagram to correctly position the jumper to give each Distribution Module a unique address.
- Also as shown in **Figure 11**, there is also a four position terminal block located on the lower left corner of the rear of the Selective Call Intercom Distribution Module. These are Open Collector outputs labeled “A” and “B” (ground and output connectors for each). At any Room Unit, you can configure the “A” Door Strike (“Release”) and/or “B” Alert (“Trigger”) outputs to be enabled or disabled. **Figure 12** shows an example of electronic door release and/or trigger wiring and **Figure 13** shows the screen sequence to enable these functions.

Figure 11

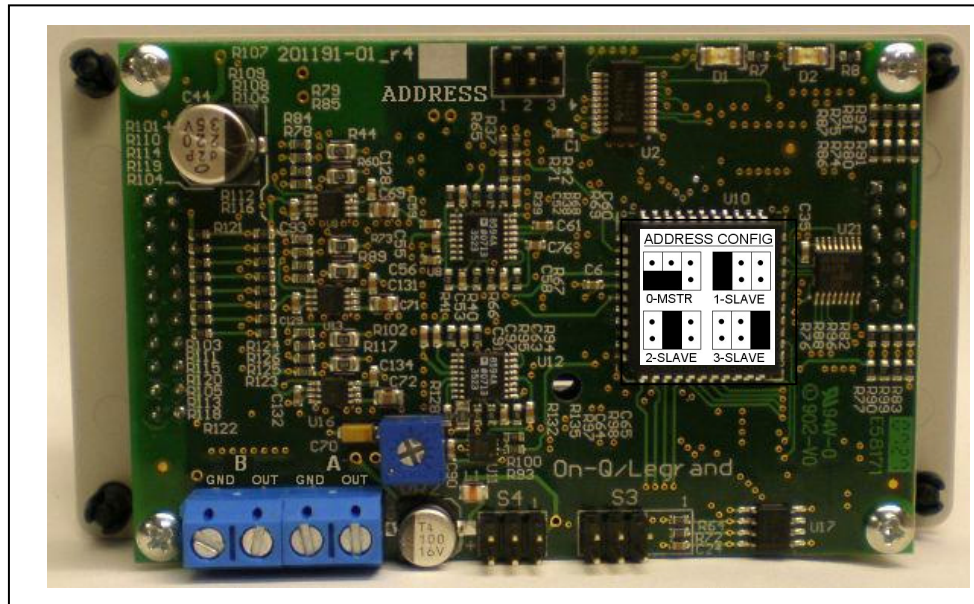
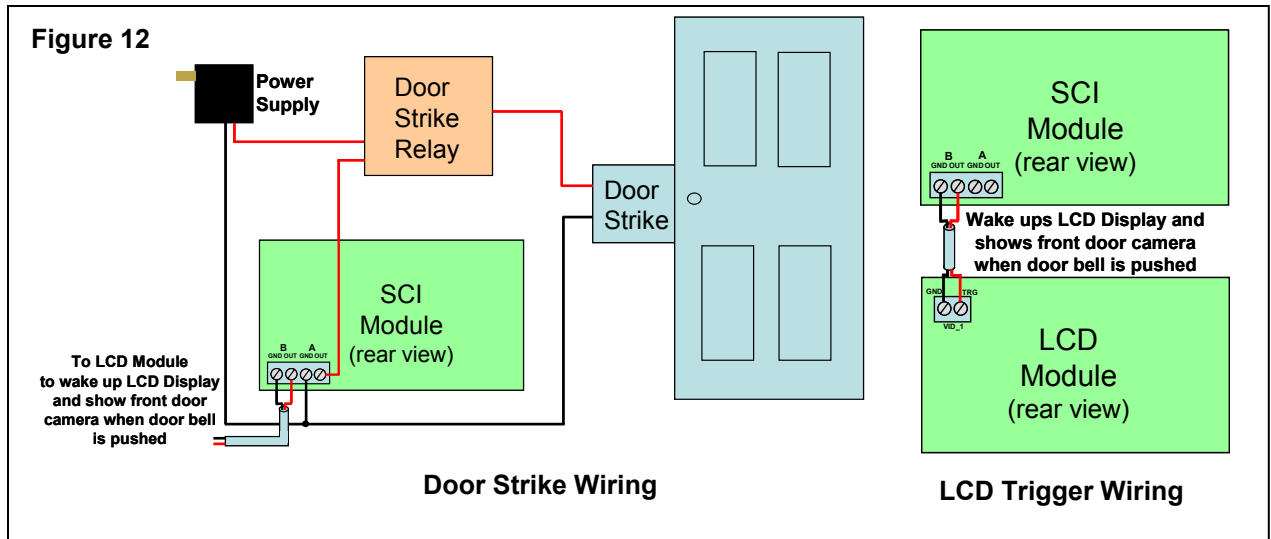

Figure 12



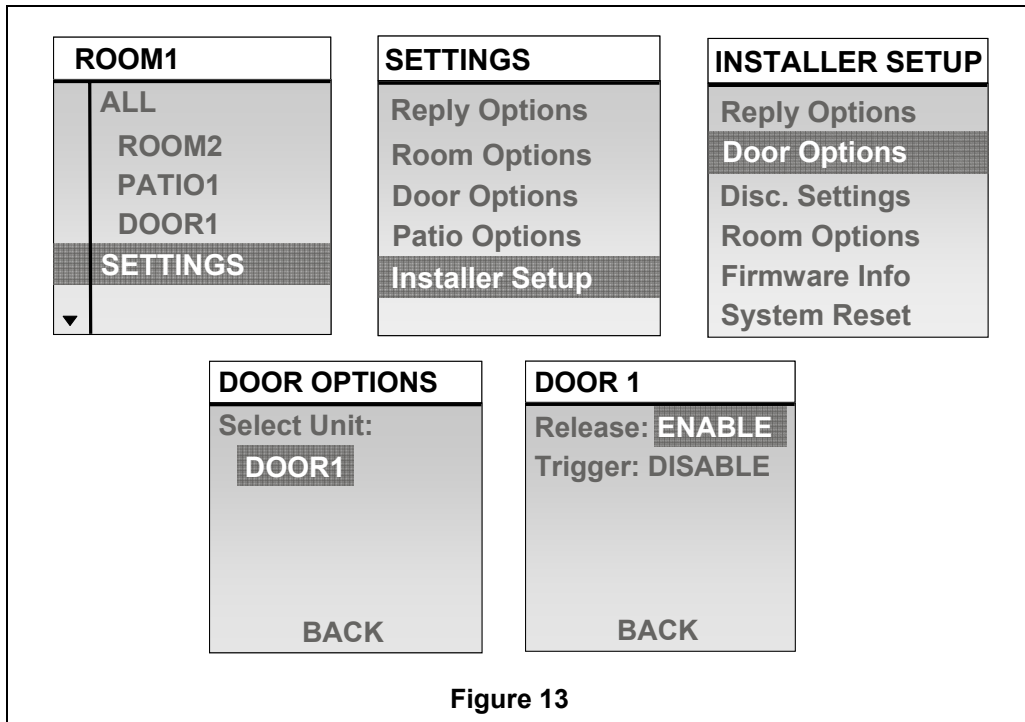

Figure 13

- Insert the Intercom Distribution Module into the mounting bracket and insert the bracket into the On-Q enclosure. Secure the Intercom Distribution Module to the bracket by depressing each plunger at each corner of the Intercom Distribution Module.
- **DONOT** apply power to the Intercom Distribution Module until all RJ45 plugs are seated in the correct jacks on the Intercom Distribution Module.
- Terminate the other end of the labeled Cat 5e cables, at the Selective Call Intercom Distribution Module, with RJ45 plugs using the T568A wiring standard and plug them into the appropriate RJ45 jack.
- After all Units and Distribution Modules are connected apply power to the Intercom Distribution Module and verify system functionality. All Selective Call Room, Door and Patio Units will be discovered (see **Figure 14**) and shown on each Room Unit LCD (see **Figure 15**).



Figure 14

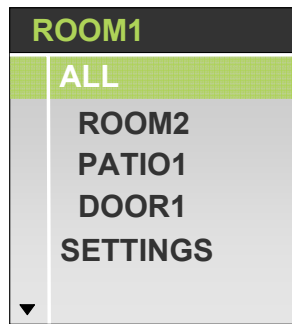

Figure 15

## V. System Configuration

The following section explains how to use any Selective Call Room Unit to configure and personalize the Selective Call System using the Settings selection from the Room Unit Main Menu (see **Figure 16**). Refer to the Selective Call System User Manual (P/N 1308001) shipped with the Selective Call Module to familiarize yourself with the operation of the Selective Call Intercom System.

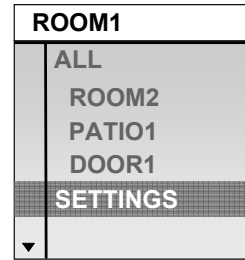

Figure 16

### A. Choosing Unit Names

This function will typically be done by the Integrator or homeowner from any Room Unit in the house. First, select “Unit Names” from the “Settings” screen (see **Figure 17**). Your local Unit Name is highlighted (see **Figure 18**) and you can press talk/select to select it or use the arrow keys to select another location. The selected Room Unit begins to beep at full volume so that it is audible from anywhere in the house. Press talk/select to change to the screen shown in **Figure 19**. Press talk/select again and use the arrow keys to select a new name from the list below (**Table 1** for Rooms or Patios and **Table 2** for Doors or Patios) and again press talk/select. The New Name shown now becomes that Unit’s name (see **Figure 20**).

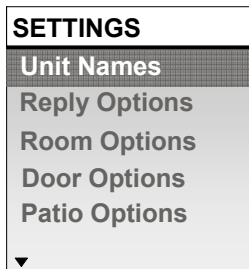

Figure 17

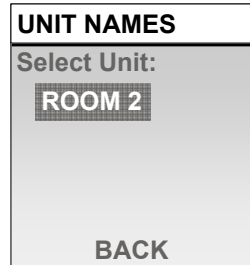

Figure 18



Figure 19

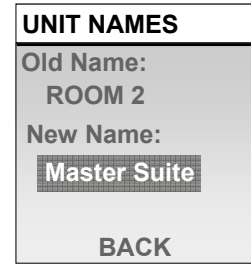

Figure 20

Attic	Dock	Kid's Room	Office 4
Baby's Room	Entertain. Rm	Kids Room 2	Office 5
Balcony	Family Room	Kids Room 3	Office 6
Bar	Foyer	Kids Room 4	Office 7
Basement	Front Desk	Kitchen	Office 8
Bath 1	Game Room	Laundry Room	Owner's Suite
Bath 2	Garage	Laundry Rm 2	Parlor
Bath 3	Gathering Rm	Library	Patio
Bedroom 1	Grandma's Rm	Living Room	Play Room
Bedroom 2	Grandpa's Rm	Lunch Room	Pool
Bedroom 3	Great Room	Main Office	Porch
Bedroom 4	Guest House	Master Bath	Powder Room
Bonus Room	Guest Bath	Master Closet	Reading Room
Break Room	Guest Room	Master Deck	Rec Room
Breakfast Rm	Guest Suite	Master Suite	Sitting Area
Casita	Hallway 2	Media Room	Study
Closet	Hallway	Mom's Room	Sun Room
Computer Rm	Hobby Room	Mud Room	Utility Room
Dad's Room	Home Office	Nook	Veranda
Deck	Home Office 2	Office	Waiting Room
Den	Home Theater	Office 2	Wine Cellar
Dining Room	In-Law Suite	Office 3	Workshop

Table 1



Back Door	Casita	Front Gate	Patio
Back Gate	Deck	Front Porch	Porch
Balcony	Dock	Garage	Side Door
Balcony 2	Front Door	Guest House	Veranda
Basement Door	Front Entry	Master Deck	

**Table 2**

## B. Modifying Hands-Free Reply Options

This option may be configured by the Integrator or homeowner from one Room Unit in the house. This global option affects all Room and Patio Units, and determines the amount of time a receiving unit remains in hands free reply mode. From the Settings screen (see **Figure 21**), select Reply Options. Press talk/select and use the arrow keys to select the desired Hands-Free Reply time (see **Figure 22**). The options are 60 seconds, 30 seconds, 15 seconds, 10 seconds (the default), 5 seconds, or disabled. Door Reply times are separately configured under Installer Setup.

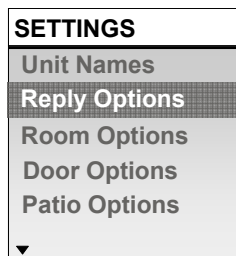

**Figure 21**

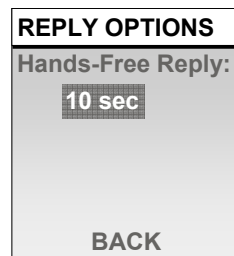

**Figure 22**

## C. Room Options (Local Settings)

These options may be configured by the Integrator or homeowner from any Room Unit in the house by selecting "Room Options" from the Settings screen (see **Figure 23**). All of the Room Options are specific only to the local Room Unit. The first setting "LCD Brightness:" (see **Figure 24**) determines how bright or dim you would like that Room Unit to operate at. "Chime Volume:" determines how loud or soft the door chime will play when someone pushes a Door Unit button. "Monitor" and "Mute" can be turned on or off, meaning those button functions may be disabled or enabled at that particular Room Unit. **Figure 25** shows that you can also determine the period of time of inactivity (1 minute-default, 5 minutes or 10 minutes) before a Room Unit goes into sleep mode (Timeout). The "Sort" function determines whether you want the list of units displayed on that Room Unit to be displayed alphanumerically (Alpha), or by usage. If you select Dynamic, units will be displayed with the most used units at the top of their section of the display.

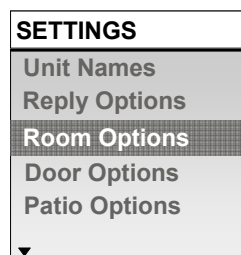

**Figure 23**

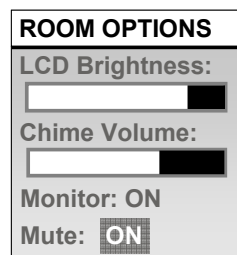

**Figure 24**

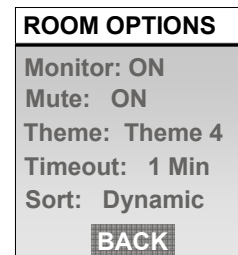

**Figure 25**

The **Theme** function (see **Figure 25**) allows you to select one of four different color pallets for that particular Room Unit's display (shown in **Figure 26**).

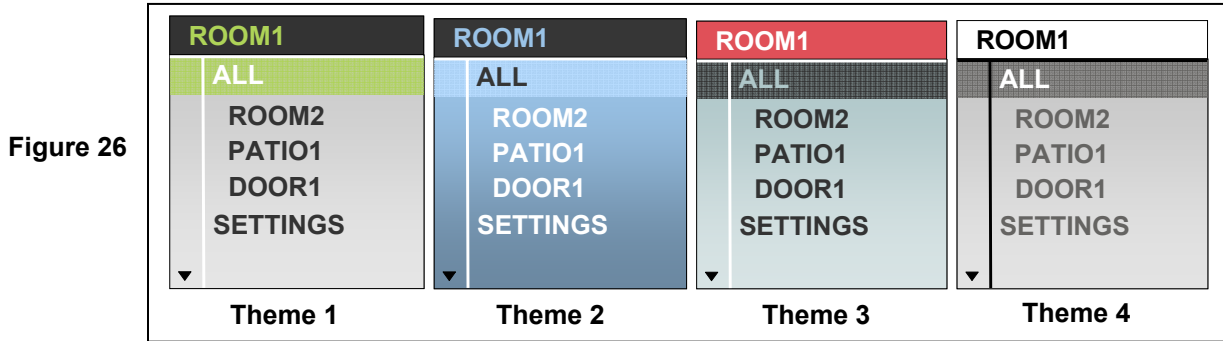

Figure 26

#### D. Door Options (Local Settings)

These options may be configured by the Integrator or homeowner from any Room Unit in the house. The Door Options are specific only to the selected Door Unit. Select "Door Options" from the Settings screen (see **Figure 27**) and use the talk/select and arrow buttons to select which Door Unit you would like to configure (see **Figure 28**). The first setting "**Chime:**" (see **Figure 29**) determines which of the 20 optional door tones will be associated with the door button on that particular Door Unit. The **Volume** and **Chime Volume** options allow you to set the default volume levels for that particular Door Unit. See **Table 3** for a complete list of Door Tones.

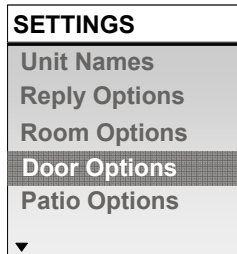

Figure 27

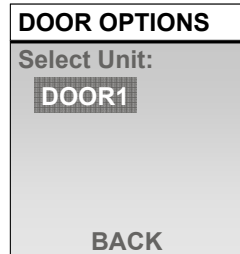

Figure 28

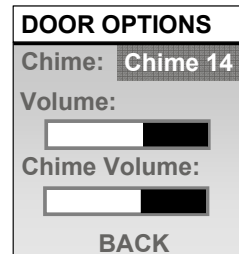

Figure 29

Table 3

#	Door Tone Name	Type
1	On-Q Sound	Chime
2	On-Q Sound Alternate	Chime
3	Westminster Long	Chime
4	Westminster Short	Chime
5	Two Note (Ding Dong)	Chime
6	Two Note (Dong Ding)	Chime
7	Jetson's Doorbell	Chime
8	Eastern Strings	Ethnic
9	Calypso Party	Ethnic
10	Für Elise	Classical
11	Beethoven's 5 <sup>th</sup>	Classical
12	Happy Birthday	Celebration
13	Pomp & Circumstance	Celebration
14	Wolf Howl	Holiday
15	Jingle Bells	Holiday
16	We Wish You a Merry Christmas	Holiday
17	Auld Lang Syne	Holiday
18	Oh Canada	Patriotic
19	America the Beautiful	Patriotic
20	On-Q Sound + Dog	Security

## E. Patio Options (Local Settings)

These options may be configured by the Integrator or homeowner from any Room Unit in the house. The Patio Options are specific only to the selected Patio Unit. Select “Patio Options” from the Settings screen (see **Figure 30**) and use the talk/select and arrow buttons to select which Patio Unit you would like to configure (see **Figure 31**). The first setting “Status:” see **Figure 32**) determines whether that Patio Unit is enabled (ON) or disabled (OFF). This is a handy feature for disabling the Patio Unit at night or while you are away. The “Volume:” option determines the default volume level at that particular Patio Unit. The “Chime Volume:” option determines the default volume level of Door Tones played at that particular Patio Unit when someone pushes the doorbell button on a Door Unit. The “All Call:” option (see **Figure 33**) enables (YES) or disables (NO) the broadcast page ability from that Patio Unit. The “Monitor:” option enables (YES) or disables (NO) the Monitor button on that particular Patio Unit. The “Time Out:” option is used to determine how quickly the Patio Unit button backlights goes to sleep after inactivity (1 minute – default, 5 minutes, or 10 minutes).

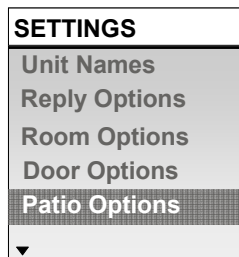

Figure 30

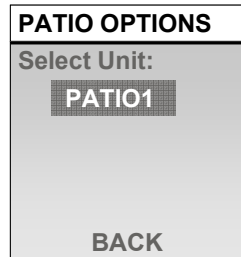

Figure 31

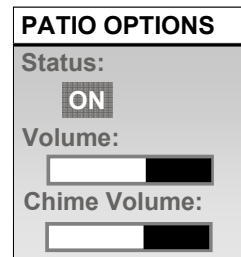

Figure 32

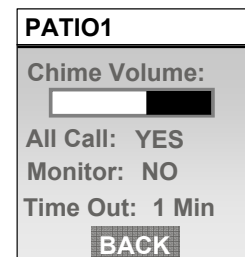

Figure 33

## F. Installer Setup

The Installer Setup options are separated from the User options, as they are either options that are typically configured only at the time of system installation, or options that are used for system update or reset. Select Installer Setup from the Settings screen (see **Figure 34**) to see a list of all the Installer Setup options (see **Figure 35**).

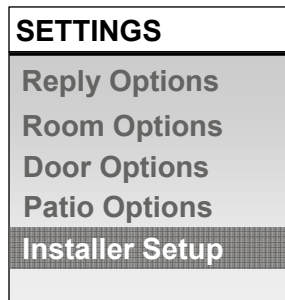

Figure 34

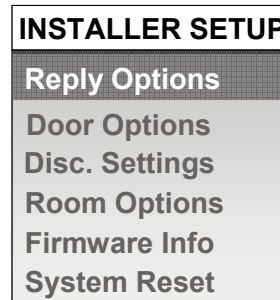

Figure 35

The Reply Options and Door Options are both related to Door Units. The reason Door Unit Reply Options is separated from Room/Patio Unit “Reply Options” (selected from the Settings screen), is that the Door Unit does not have a display, and as such must be configured from a Room Unit. One of the Installer Setup Reply Options selections is “disabled”, which means that if that option is selected, all Door Units will appear disabled, or broken.

### Door Unit Hands-Free Reply Options

The Reply Options screen (see **Figure 36**) is used to select the amount of time all Door Units remain in hands-free reply mode. The options are 60 seconds, 30 seconds, 15 seconds, 10 seconds (the default), 5 seconds, or disabled (see **Figure 37**).

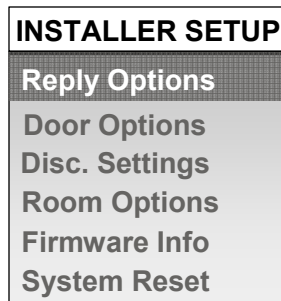

Figure 36

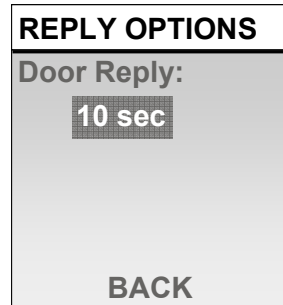

Figure 37

### Door Options

The Installer Setup Door Options (see **Figure 38**) is where you enable or disable the “A” and “B” open collector output terminals on the rear of the SCI Distribution Module. Notice it is specific to a particular Door Unit (see **Figure 39**). The “A” output is for an Electronic Door Release (see **Figure 40**) and the “B” output is for a trigger output that may be tied to a doorbell button push action, such as turn on the porch light when someone presses the door bell, as shown in **Figure 41**.

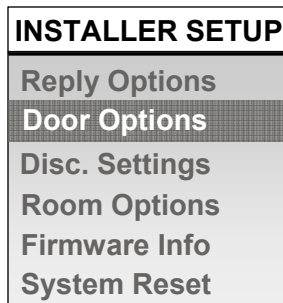

Figure 38

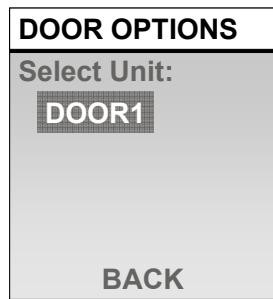
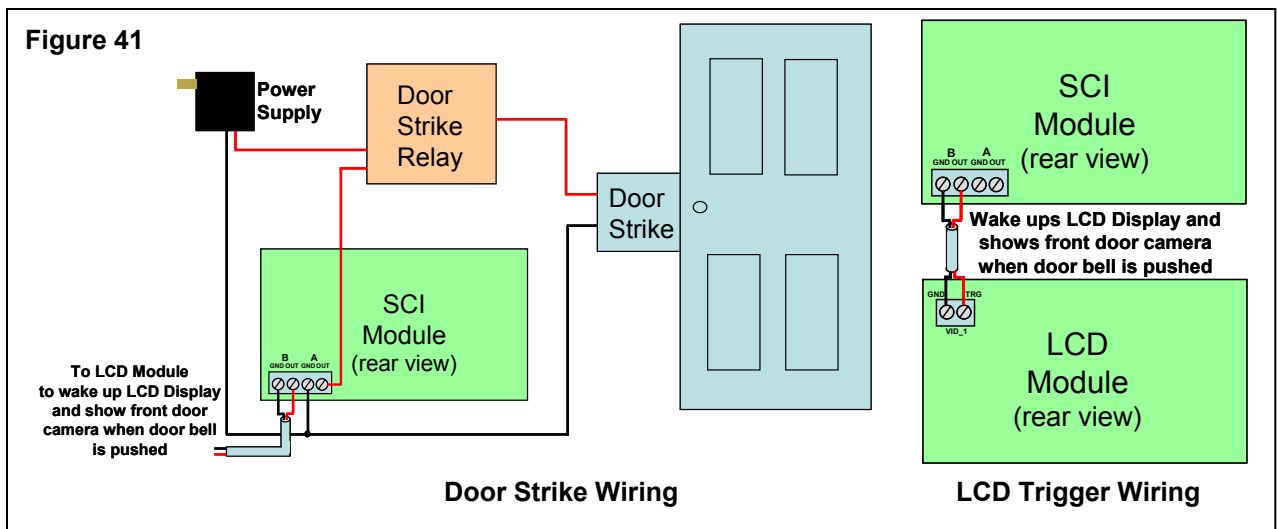

Figure 39



Figure 40



## Disc. Settings

The Discovery Settings option, selected from the Installer Setup screen (see **Figure 42**) is an option screen that allows the installer to turn ON the unit beep that occurs when units are discovered. It is turned OFF by default (see **Figure 43**) so as not to disturb homeowners at night if there is a temporary power outage and restoration of power. When turned ON, each unit in the system will beep as it is discovered upon power initialization.

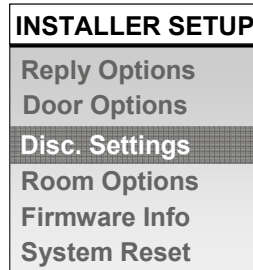

Figure 42

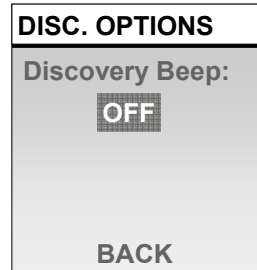

Figure 43

## Room Options

The Room Options Installer Setup option, selected from the Installer Setup screen (see **Figure 44**) is an option screen that allows the installer to adjust the contrast of the Room Unit's LCD display. This option is set at the factory (see **Figure 45**) and should not need to be adjusted, but if desired, press the talk/select button, and use the up/down arrow buttons to adjust the contrast of the display to taste.



Figure 44

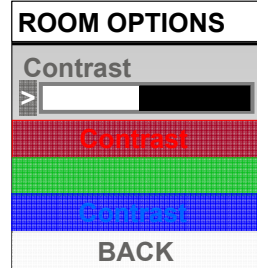

Figure 45

## Firmware Info

The Firmware Info option, selected from the Installer Setup screen (see **Figure 46**) is an option screen that displays the Unit Name, firmware revision and address of that particular Room Unit (see **Figure 47**). This information may be very handy if the installer is troubleshooting a problem over the phone with On-Q Technical Support.

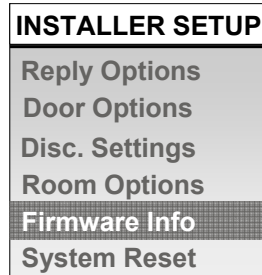

Figure 46



Figure 47

## System Reset

The System Reset option, selected from the Installer Setup screen (see **Figure 48**) performs a total system reset, which takes all Units back to factory settings (see **Table 4**). When you select System Reset (see **Figure 49**) and press talk/select, a Warning screen (see **Figure 50**) appears briefly to remind you that you are going to erase all names and settings. Then you are asked to hold the Volume plus (+) and Volume minus (-) keys down at the same time to perform the reset (see **Figure 51**). Shortly after you release those Volume keys, you should see a screen similar to the one shown in **Figure 52** and once the system has finished its reset, a Room Unit screen similar to the one shown in **Figure 53** will be seen.

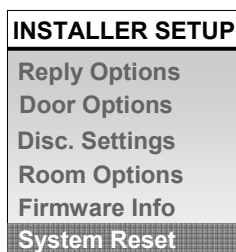

Figure 48

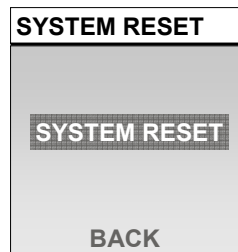

Figure 49

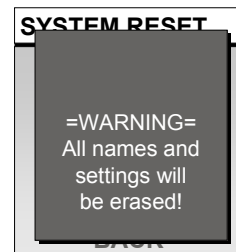

Figure 50

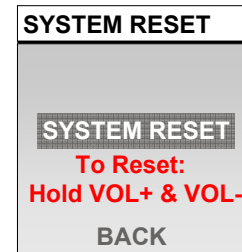

Figure 51

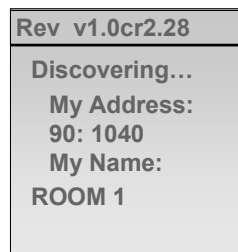

Figure 52

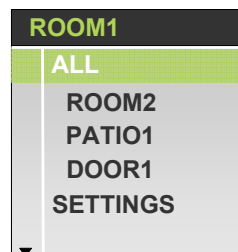

Figure 53

### System Default Values

<b>Default Unit Names:</b>	ROOM 1-8 DOOR 1-8 PATIO 1-8
<b>Default Reply Options:</b>	
Hands-Free Reply Room:	10 seconds
Hands-Free Reply Patio:	10 seconds
<b>Default Room Options:</b>	
Room Volume + / -	75%
LCD Brightness:	90%
Chime Volume:	75%
Monitor:	ON
Mute:	ON
Theme:	Theme 1
Time Out:	1 minute
Sort:	Dynamic
<b>Default Door Options:</b>	
Chime #:	Chime #1
Volume:	70%
Chime Volume:	75%
<b>Default Patio Options:</b>	
Status:	ON
Volume:	70%
Chime Volume:	75%
All Call:	NO
Monitor:	NO
Time Out:	1 minute
<b>Installer Setup:</b>	
Default Unit Power-Up Beep	OFF
Default LCD Contrast:	Determined at factory
Default Door Reply Options:	
Hands-Free Reply Door:	10 seconds
Default Door Options:	
Release:	Disabled
Trigger:	Disabled

**Table 4**

## VI. Troubleshooting

This section will detail possible solutions to common problems that might occur during installation of or in using the On-Q/Legrand Selective Call Intercom System.

### A. Contact Information

If you are unable to locate a solution here, please access our website at [www.onqlegrand.com](http://www.onqlegrand.com) for the latest information. You can also reach us at 1-800-321-2343.

### B. Troubleshooting Guide

Problem	Solution
No power to any intercom unit	<ul style="list-style-type: none"> <li>-Check Intercom Module power LED to verify that it is lit. If not, make sure power supply is plugged in.</li> <li>-Verify that you are using the correct 24V power supply for your system by obtaining the model number and calling your On-Q installer or On-Q Technical Support.</li> </ul>
No power to a specific Room Unit, Patio Unit, or Door Unit	<ul style="list-style-type: none"> <li>-Check the Cat 5e cable terminations at both the rear of the Unit and at the Intercom Module. Verify that your terminations follow the T568A wiring standard.</li> <li>-If your wiring terminations are visibly correct according to the T568A standard, test the conductivity of the connections, and re-terminate if a problem is found.</li> <li>-Check to see if a Unit will power on by plugging it into a different port on the Intercom Module.</li> </ul>
Feedback or squeal noise from a Room Unit, Patio Unit, or Door Unit speaker	<ul style="list-style-type: none"> <li>-Verify Unit placement. Avoid placing Units back to back on a common wall. If Units must be placed on both sides of a common wall, do so in a manner which avoids feedback problems, ensuring that the audio from a Unit's speaker will not be audible to a nearby Unit's microphone.</li> <li>-Feedback issues can normally be eliminated by adjusting the volume of a Unit from a high level to a medium level.</li> </ul>
Hum or buzzing noise that can be heard in some or all units of the Selective Call Intercom System	<ul style="list-style-type: none"> <li>-Verify that the proper wiring guidelines, found in this manual, have been followed.</li> <li>-Verify that Cat 5e cabling does not run parallel to and within 12 inches of AC power cabling. Also avoid running Cat 5e cabling near florescent lighting fixtures, dimmer switches, or fan controls.</li> </ul>

**Table 5**



## C. Warranty Information

### LIMITED ONE YEAR PRODUCT WARRANTY

On-Q/Legrand ("On-Q") warrants to the original end user ("*Customer*") that those products manufactured by or for On-Q ("*Warranted Products*"), as conclusively evidenced by the name or logo of On-Q appearing on the product, will be free from defects in workmanship and materials, under normal use, for (1) one year from the date of original purchase from On-Q or its authorized dealer or installer. The sole obligation of On-Q under this express warranty shall be, at the option and expense of On-Q, to replace the product with a comparable product, or repair the product. In no event shall On-Q be liable for incidental, consequential, or punitive damages, or for labor or other costs in connection with diagnosing, repairing, removing, installing, shipping, servicing, or handling the defective product. Replacement products may be new, rebuilt, remanufactured or reconditioned. On-Q warrants any replaced or repaired product for a period of ninety (90) days from shipment, or through the end of the original warranty period, whichever is longer. On-Q makes no warranty with respect to products it sells that do not contain the authorized On-Q name or logo, and Customer, by acceptance of the product, agrees that its sole and exclusive remedy shall be against the manufacturer of such product.

The foregoing warranty for Warranted Products does not extend to (i) damage or repairs required as a result of improper wiring, misuse, misapplication, abuse, improper servicing, unauthorized alteration, improper operation, or handling, storage, installation, or operation that is not in accord with instructions that may be furnished with the product; (ii) failures due to abnormalities in or interruption of electrical service; or (iii) damage caused by lightning, floods, winds, fires, accidents, corrosive atmosphere, temperature extremes, or other conditions that are beyond the control of On-Q. Original purchases or replacement products may be new, rebuilt, remanufactured or reconditioned. This warranty gives the Purchaser specific legal rights, and the Purchaser may also have other rights which vary from state-to-state. Some states do not allow limitations on how long an implied warranty lasts, so the above limitation may not apply to the Purchaser. Some states do not allow the exclusion or limitation of incidental or consequential damages, so the above limitation or exclusion may not apply to the Purchaser.

### Obtaining Warranty Service

**Customer must contact an On-Q authorized Dealer or Installer within the applicable warranty period to obtain warranty service. Dated proof of original purchase from On-Q or its authorized Reseller or Dealer will be required.**



301 Fulling Mill Road, Suite G  
Middletown, PA 17057  
(800)-321-2343

©Copyright 2008 by On-Q/Legrand,  
Inc All Rights Reserved.  
[www.onqlegrand.com](http://www.onqlegrand.com)

## VII. Installer Checklist

This checklist is provided to help the installer keep track of Unit Names and Options as part of the installation process.

Global Rm/Patio	Hands Free Reply: 5,10,15,30,60,dis.							
Room #1	New name	FW rev	Address	Sort: D/A	Mute: On/Off	Mon: On/Off	T/O: 1,5,10	Theme: 1,2,3,4
Room #2	New name	FW rev	Address	Sort: D/A	Mute: On/Off	Mon.: On/Off	T/O: 1,5,10	Theme: 1,2,3,4
Room #3	New name	FW rev	Address	Sort: D/A	Mute: On/Off	Mon.: On/Off	T/O: 1,5,10	Theme: 1,2,3,4
Room #4	New name	FW rev	Address	Sort: D/A	Mute: On/Off	Mon.: On/Off	T/O: 1,5,10	Theme: 1,2,3,4
Room #5	New name	FW rev	Address	Sort: D/A	Mute: On/Off	Mon.: On/Off	T/O: 1,5,10	Theme: 1,2,3,4
Room #6	New name	FW rev	Address	Sort: D/A	Mute: On/Off	Mon.: On/Off	T/O: 1,5,10	Theme: 1,2,3,4
Room #7	New name	FW rev	Address	Sort: D/A	Mute: On/Off	Mon.: On/Off	T/O: 1,5,10	Theme: 1,2,3,4
Room #8	New name	FW rev	Address	Sort: D/A	Mute: On/Off	Mon.: On/Off	T/O: 1,5,10	Theme: 1,2,3,4
Door #1	New name	FW rev	Address	Chime#:	Release.: E/N	Trigger: E/N	Door Reply: 5,10,15,30,60,dis	
Door #2	New name	FW rev	Address	Chime#:	Release.: E/N	Trigger: E/N	Door Reply: 5,10,15,30,60,dis	
Patio #1	New name	FW rev	Address	Page: Y/N	Status: On/Off	Monitor.: Y/N	Timeout: 1,5,10	
Patio #2	New name	FW rev	Address	Page: Y/N	Status: On/Off	Monitor.: Y/N	Timeout: 1,5,10	

**Table 6**