

F

Ocal® - Corrosion-resistant conduit systems



—
F

Ocal - Corrosion-resistant conduit systems



Table of contents

Section F

ABB Services	F4
Overview	F5
PVC-coated conduit and accessories	F12
PVC-coated conduit bodies and fittings	F22
PVC-coated boxes and covers	F43
PVC-coated hazardous location fittings	F45
PVC-coated strut and accessories	F51
Ocal installation products	F56
Technical Information	F66
Recommended installation procedures	F72

ABB Services

Ocal PVC-coated conduit and fittings and other ABB products – better by design to stand up to your most demanding corrosive environments.

When you're dealing with the world's most corrosive environments, just any PVC-coated conduit won't do.

- Ocal has industry leading thread protection through a hot-dipped galvanizing process, and industry leading UL® Listed Type 4X PVC-coated conduit bodies.
- Ocal offers a full undisturbed zinc coating under the PVC coating, fulfilling the requirement of NEMA RN-1 regarding the restriction of harmed or eroded zinc coating over the conduit.
- Ocal is UL Listed with both the zinc coating and the PVC coating investigated and listed per UL6.
- Ocal is UL Listed including UV resistance testing
- Ocal has “Double-Coat” coated fittings, enhancing corrosion protection by applying coating to the interior and exterior of the fittings before PVC coating.

Which line of PVC-coated conduit, fittings and accessories can you trust to provide a complete corrosion-protection package for your entire electrical raceway system, extending its life for years to come? Ocal-Blue®.

At ABB, we're committed to:

- Convenience of single-order, single shipment to your site for thousands of stocking items
- Expert local point of contact for clear, consistent information regarding training, codes and standards
- Quality brands that have proven themselves over time
- Inventive design and manufacture of problem-solving products
- Offering a best-of-class warranty and returns policy
- Uniform carton labeling with additional bar-coding for convenient inventory management
- Nationwide network of stocking electrical distributors
- Outstanding customer service capability
- Supplying you with the right products, convenient packaging, on-time delivery and competitive pricing

We deliver the solutions that make your job easier and offer the power to bring it all together in one package. Call us today and let us help you profit from sourcing your electrical products from the leader, ABB.



Overview

Ocal – better by design

Ocal PVC-coated conduit and fittings represent a complete corrosion protection package for your entire conduit system. This extensive product line includes the largest number of items in stock along with corrosion resistant supports and patching compounds. With Ocal PVC-coated conduit and fittings, you get corrosion protection that will extend the life of your electrical raceway system for years and years.

A complete corrosion protection solution

- UL Listed with both the zinc coating and the PVC coating investigated and listed per UL6.
- Industry leading thread protection through a hot-dipped galvanizing process, and industry leading UL Listed Type 4X PVC-coated conduit bodies.
- A full undisturbed zinc coating under the PVC coating, fulfilling the requirement of NEMA RN-1 regarding the restriction of harmed or eroded zinc coating over the conduit.
- Meets the requirements of NEMA RN-1 without exception.
- UL Listed including UV resistance testing.
- “Double-Coat” coated fittings, enhancing corrosion protection by applying coating to the interior and exterior of the fittings before PVC coating.
- Custom colors.

- On-site installation training and certification, and extended warranty on installations conducted by certified installers.

Standards met

- ANSI C80.1
- Federal Specification WW-C-581
- NEMA RN-1
- UL6



Overview

What is corrosion?

Corrosive elements cause millions of dollars in damage through lost time, materials and labor.

Corrosion protection of electrical conduit systems

Corrosion protection options

Chemical Category	Chemical Examples	Compatibility Rating							
		PVC	URETHANE	304 Stainless Steel	316 Stainless Steel	Poly Carbonate	Cast Iron	Brass	Aluminum
Solvents (excluding alcohols and aliphatic)	Acetone, toluene, ketones, etc.	NR	NR	L	L	NR	L	L	L
Fuels	Jet fuel (alcohol based and aliphatic solvent based)	L	L	L	L	L	L	L	L
Plating Solutions	Chrome, nickel, copper, brass, gold, zinc, etc.	L	F	F	F	F	NR	NR	NR
Salts and Alkaline Materials	Caustic soda, caustic potash, alkaline cleaners, etc.	L	F	L	L	F	NR	NR	NR
Mild Acids	Low-concentration hydrochloric, sulfuric, fruit acids, glycolic, citric, etc.	L	S	L	L	S	NR	NR	NR
Strong or High-Purity Acids	Nitric, hydrofluoric, etc.	S	S	F	F	S	NR	NR	NR
Oxidizing Agents	Bleach, chlorine, hydrogen peroxide, etc.	L	S	L	L	S	NR	NR	NR

Chemical compatibility legend

Suitability Description	Compatibility Rating
Rated for all Fumes, Splash & Liquid	L
Rated only for Fumes & Splash	S
Rated for Fumes only	F
Not Recommended	NR

The chart above provides a general guide for the end user to choose the most suitable material for corrosion protection. Compatibility with chemical environment should be thoroughly evaluated for each installation.

As you can see, PVC-coated conduit and fittings are suitable for almost all applications. When it comes to PVC-coated conduit systems, there is no higher quality than Ocal.

Examples of corrosion



Overview

Ocal manufacturing process

The Ocal PVC-coated conduit system fully complies with all standards for proper use and protection in corrosive environments mandated by UL6, NEMA RN-1 and ANSI C80.1. It is manufactured right here in the United States by ABB in our Jonesboro, AR manufacturing facility.

The process of manufacturing PVC-coated conduit

01 The process begins with 20-foot (6 meters) sticks of raw steel shell.

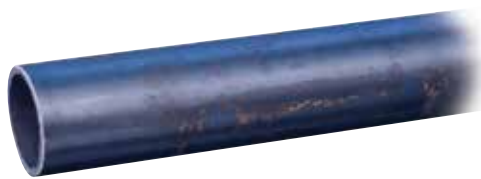

01

02 The steel shell is cut, threaded and prepared for the hot-dip galvanizing process.

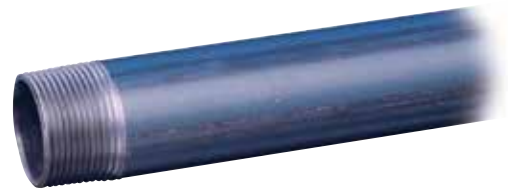

02

03 The threaded shell is immersed in a molten zinc bath. This hot-dip galvanizing process enables the zinc to penetrate the steel, providing the best possible protection. After the conduit is extracted from the zinc bath, super-heated steam is blown through the interior and over the outside of the conduit to remove any slag. The ends of the conduit are heated enough to blow excess zinc out of the thread cavities. ABB manufactures steel conduit that hot-dip galvanizes the threads as well as the conduit itself. Other methods such as "hot galvanizing" provide only a sprayed-on zinc coating.



03



04

04 Prior to the exterior PVC coating, 2 mils (nominal) of blue urethane is applied to the inside diameter as well as the threads of each conduit. After priming, the conduit is heated and then rolled through liquid plastisol, achieving complete coverage of 40 mils in thickness.

05 Standard colors include gray, white and blue. 5 Custom colors also available.

Ocal offers

- Plant walk-throughs
- Installation training and certification
- Installation tools
- The expertise to ensure that you get the maximum benefit of the Ocal-Blue total protection system
- Manufacturing capabilities that ensure unmatched delivery time on custom orders, special colors or large quantities
- Protection of each shipment with special packaging for damage-free delivery

Superior Service

Our reputation for dependability and customer service has made Ocal the most trusted name in corrosion protection for the electrical industry.



Overview

Complete corrosion protection

Ocal has developed a process for coating the interior and exterior of all fittings with a nominal .002" (2 mils) of blue urethane, which is baked on. This proprietary application of urethane enhances the corrosion protection of your system, even if you accidentally nick or cut the PVC coating during installation. Flexible, overlapping sleeves on all Ocal fittings guarantee protection with a vapor- and moisture-tight seal at every connection.

The process of manufacturing PVC-coated fittings

- Fittings are cleaned and then sprayed inside and outside with 2 mils (nominal) of blue urethane
- This gives the fittings corrosion protection on the exterior as well as the interior – all fittings are “double-coated”
- 40 mils of PVC is applied to the exterior of the fitting
- Covers are coated with a molded flange and molded integral O-ring seal for 2½" - 4" Form 8 and all Form 7. Conduit bodies are molded with a flat surface to ensure a superior seal
- Standard colors include gray, white and blue. Custom colors also available

ABB takes pride in providing PVC-coated conduit and fittings compliant with industry wide recognized standards. It is this dedication to superior quality that makes Ocal “Better by Design.”

Ocal-Blue Double-coat UL Listed Type 4X and NEMA

4X Form 8 conduit bodies

For the conduit system that has to stand up to a corrosive environment, the newly designed Ocal-Blue Type 4X Form 8 conduit body meets the challenge. The key is in the cover. Ocal takes a cast cover and then injection molds a PVC coating around it with an integral O-ring seal.

There's no need for tools or gaskets. To meet the harsh requirements of the UL Type 4X listing, you need only hand-tighten the stainless steel encapsulated screws to 15 in.-lbs of torque – as compared to the 35 in.-lbs of torque required to tighten cover screws on competitors' conduit bodies.

Ideal for providing corrosion-resistant performance in washdown and other tough applications, Ocal-Blue Type 4X Form 8 PVC-coated cast-iron conduit bodies are now available in sizes up to 2". Look for the blue to know it's a high-quality ABB product.

Overview

Complete corrosion protection

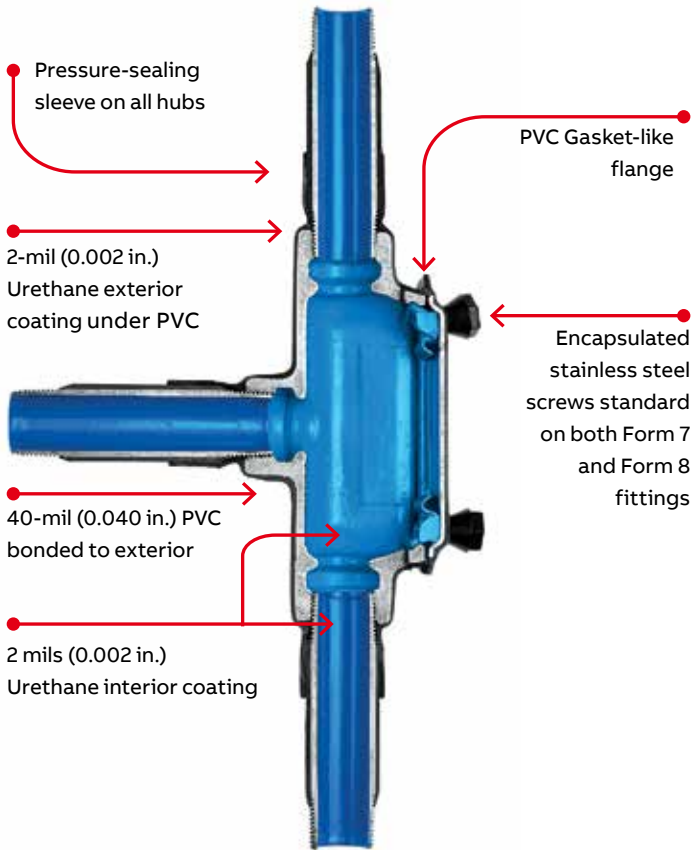

Ocal supplies encapsulated screws on both Form 7 and Form 8 fittings.



2" C Form 8 conduit body and cover

Overview

Evaluating corrosion protection of PVC-coated conduit

—
01 Example of Hot-Dip Galvanized Threads after 42-day salt-fog test

—
02 Example showing how a Zinc coating surpasses the requirement for corrosion resistance

When evaluating any electrical raceway conduit or fittings, applicable standards should be referenced. The three standards that address the design and performance of PVC-coated rigid steel conduit are ANSI C80.1, UL6 and NEMA RN-1. ANSI C80.1, UL and NEMA have determined the appropriate ASTM standards and test methods that apply.

Hot-Dip Galvanized Threads

Since electrical conduit systems breathe, the threads will be exposed to the corrosive environment for the duration of the installation. NEMA RN-1-2005 is the electrical industry's standard for PVC externally coated galvanized rigid steel conduit. Section 2.1 of this standard states, "Where unusually corrosive environments are encountered, it is recommended that threads be given additional protection suitable for the intended application." Hot-dip galvanizing is the process through which the steel shell is dipped in molten zinc, causing the zinc to penetrate the steel. Ocal hot-dip galvanizes the threads of the conduit, in addition to the conduit itself. This gives the threads the protection recommended in corrosive environments.

A compelling demonstration of the protection hot-dip galvanizing provides is shown below, using a common corrosive agent, salt, on hot-dip galvanized threads. UL6, the standard for rigid metal conduit, references ASTM B117 for evaluating protective coatings. Below are the results of a salt-fog test using the standard test method ASTM B117.



—
01

Galvanized conduit underneath the PVC coating – Preece test

With so much riding on the integrity of their electrical conduit systems, facilities need the superior protection offered by the ABB Ocal PVC-coated conduit systems. The simple fact is that Ocal PVC-coated conduit system complies fully with the design and performance

standards for PVC-coated conduit set forth by UL6, NEMA RN-1 and ANSI C80.1. ANSI C80.1, UL6 and NEMA RN-1 have determined the appropriate ASTM standards and test methods that apply, and the Preece test is one test that must be passed to be in full compliance.

Why is the Preece test relevant to PVC-coated conduit?

In cases where the PVC protection is accidentally breached, resulting from cuts, scrapes, etc., it is critical to have a second line of defense – a zinc, or galvanized, coating. The zinc coating will significantly slow corrosion and allow more time for repairs. Conduit systems without adequate zinc protection underneath the PVC coating are most likely to suffer catastrophic corrosion damage. This is why NEMA RN-1 section 3.1.1 requires the proper and correct treatment of galvanized conduit before it is PVC coated. It states, "The surface shall be cleaned in such a manner that the galvanized surface of the conduit is not harmed or eroded."



—
02

The purpose of the Preece test is to evaluate the zinc coating on galvanized rigid conduit to ensure adequate protection from corrosion per UL6.2.2. The test will also determine if the surface of the conduit has been damaged as a result of preparation for PVC coating.

In evaluating the test results, the conduit receives a passing grade when the sample does not show a bright, adherent deposit of copper after four 60-second immersions in the copper sulfate solution. The conduit showing the bright, firmly adhering copper has failed to provide adequate zinc protection against corrosion.

The Preece test follows procedures set forth by UL6.2.2 and ASTM A239 and is the test recognized by UL6, NEMA RN-1 and ANSI C80.1 to adequately assess zinc protection for rigid steel conduit. The Ocal line of PVC-coated conduit systems, manufactured by ABB, complies with UL6, NEMA RN-1 and ANSI C80.1 without exception.

Overview

Adhesion test

01 **Step 1** consists of two cuts through the plastic to the substrate along the length of the conduit, approximately 1/2" apart and 3" to 4" in length. A third, perpendicular cut crosses the lengthwise parallel cuts.

02 **Step 2** calls for the edge of the PVC that was cut on the perpendicular to be carefully lifted to form a plastic tab.

03 **Step 3** the tab is pulled perpendicular to the conduit with a pair of pliers. The plastic tab will tear off rather than having any peeling effect or the coating separating from the substrate.

04 **Step 4** is the evaluation of the test, which in this case, results in a passing grade for Ocal. This result is more testimony to the fact that Ocal is "Better by Design."

The evaluation process for adhesion of PVC coating on conduit is governed by NEMA RN-1 section 3.8, Adhesion, which states, "The adhesion of the PVC coating to the conduit shall be greater than the strength of the coating itself." This adhesion test is straightforward and simple.

There are no specialized conditions necessary to perform this test. Ocal routinely performs quality-control testing – including the adhesion test – on conduit as it rolls off the line. Conduit that passes this test demonstrates that the adhesion will provide years of trouble-free service.

The following demonstration shows Ocal PVC-coated conduit being subjected to the adhesion test.



01



02



03



04

Results

With Ocal PVC-coated conduit and fittings, you get corrosion protection that will extend the life of your electrical raceway systems for years and years.



Ocal-Blue conduit

The ultimate in corrosion protection

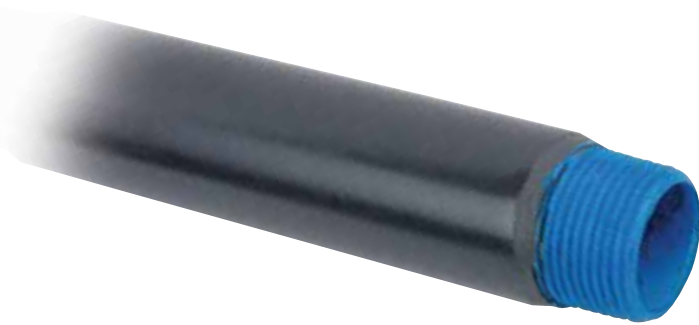

Product features

- Hot-dip galvanized steel or aluminum conduit
- Nominal .002" (2 mil) blue urethane coating on interior
- Hot-dipped galvanized threads (steel)
- Minimum .040" (40 mil) PVC coating on exterior – in your choice of blue, white, gray or custom colors
- Color-coded thread protectors
- Couplings shipped with conduit are packaged separately

Ocal-Blue conduit



Cat. No.		Pipe Size (in.) Metric Size Designator*	Outside Diameter Steel Only (in.) (mm)	Outside Diameter with PVC (in.) (mm)	Nominal Wall Thickness Steel Only (in.) (mm)	Nominal Wall Thickness with PVC (in.) (mm)	Nominal Inside Diameter (in.) (mm)	Cross Section Area in Square (in.) (mm)	Length without Couplings (ft) (m)	Minimum Weight per Foot Steel only (lbs) (kg)
Steel	Aluminium	1/2	0.84	0.92	0.10	0.14	0.63	0.30	9'11 1/4"	0.79
		16	21.30	23.30	2.64	3.56	16.10	7.72	3.03	0.36
COND3/4-	COND3/4SA-	3/4	1.05	1.13	0.11	0.15	0.84	0.53	9'11 1/4"	1.05
		21	26.70	28.70	2.71	3.73	21.20	13.53	3.03	0.48
COND1-	COND1SA-	1	1.32	1.40	0.13	0.17	1.06	0.86	9'11"	1.53
		27	33.40	35.40	3.20	4.21	27.00	21.94	3.02	0.69
COND1-1/4-	COND1-1/4SA-	1 1/4	1.66	1.74	0.13	0.17	1.39	1.50	9'11"	2.01
		35	42.20	44.10	3.37	4.39	35.40	37.97	3.02	0.91
COND1-1/2-	COND1-1/2SA-	1 1/2	1.90	1.98	0.14	0.18	1.62	2.04	9'11"	2.40
		41	48.30	50.20	3.50	4.52	41.20	51.71	3.02	1.09
COND2-	COND2SA-	2	2.38	2.46	0.15	0.19	2.08	3.36	9'11"	3.32
		53	60.30	62.30	3.70	4.72	52.90	85.21	3.02	1.51
COND2-1/2-	COND2-1/2SA-	2 1/2	2.88	2.96	0.19	0.23	2.49	4.80	9'10 1/2"	5.27
		63	73.00	75.00	4.90	5.91	63.20	121.61	3.01	2.39
COND3-	COND3SA-	3	3.50	3.58	0.21	0.25	3.09	7.39	9'10 1/2"	6.83
		78	88.90	90.90	5.20	6.22	78.50	187.80	3.01	3.10
COND3-1/2-	COND3-1/2SA-	3 1/2	4.00	4.08	0.22	0.26	3.57	9.87	9'10 1/4"	8.31
		91	101.60	103.60	5.46	6.47	90.70	250.60	3.00	3.77
COND4-	COND4SA-	4	4.50	4.58	0.23	0.27	4.05	12.73	9'10 1/4"	9.73
		103	114.30	116.30	5.71	6.73	102.90	323.34	3.00	4.41
COND5-	COND5SA-	5	5.56	5.64	0.25	0.29	5.07	20.01	9'10"	13.14
		129	141.30	143.30	6.22	7.23	128.90	508.15	3.00	5.96
COND6-	COND6SA-	6	6.63	6.71	0.27	0.31	6.09	28.89	9'10"	17.46
		155	168.30	170.30	6.75	7.87	154.80	733.83	3.00	7.92

Note – Inches, feet and pounds are indicated in bold type. Metric measure is directly below bold type.
* Metric size designator (ANSI C80.1-1994).

Cat. No.	Size	Material	Colour
COND 3/4	3/4	SA	Blank
		Blank = Steel	_ = space for color identifier
		SA = Aluminum	G = Gray
			W = White
			B = Blue
Custom colors also available.			

Catalog No. Example:
COND3/4-G is 3/4" steel conduit coated in gray PVC.



Ocal-Blue couplings

Corrosion-protected connections for conduit sections



Product features

- Nominal .002" (2 mil) blue urethane coating on interior and threads
- Minimum .040" (40 mil) PVC coating bonded to exterior – in your choice of blue, white, gray or custom colors
- Straight threads (NPS)
- Molded ribs on outer coating for easy installation
- (up to and including 4" trade size)
- Pressure-sealing sleeves protect your connection separately

Ocal-Blue couplings



Cat. No.	Coupling Size (in.) Metric Size Designator*		Minimum Length of Metal (in.) (mm)	Total Minimum Length Including Sleeve (in.) (mm)	Weight Steel only (lbs) (kg)
	Steel	Aluminium			
CPL1/2- <u> </u>	CPL1/2SA- <u> </u>	1/2	1.50	3.75	0.13
		16	38.10	95.25	0.06
CPL3/4- <u> </u>	CPL3/4SA- <u> </u>	3/4	1.53	3.75	0.19
		21	38.91	95.25	0.85
CPL1- <u> </u>	CPL1SA- <u> </u>	1	1.91	4.94	0.33
		27	48.41	139.70	0.15
CPL1-1/4- <u> </u>	CPL1-1/4SA- <u> </u>	1 1/4	1.91	5.50	0.43
		35	48.41	139.70	0.19
CPL1-1/2- <u> </u>	CPL1-1/2SA- <u> </u>	1 1/2	1.91	5.75	0.56
		41	48.41	146.05	0.25
CPL2- <u> </u>	CPL2SA- <u> </u>	2	1.94	5.94	0.77
		53	49.19	150.79	0.35
CPL2-1/2- <u> </u>	CPL2-1/2SA- <u> </u>	2 1/2	2.88	6.88	1.85
		63	73.10	174.70	0.83
CPL3- <u> </u>	CPL3SA- <u> </u>	3	3.03	7.03	2.70
		78	76.98	178.58	1.22
CPL3-1/2- <u> </u>	CPL3-1/2SA- <u> </u>	3 1/2	3.09	7.09	3.78
		91	78.58	180.18	1.70
CPL4- <u> </u>	CPL4SA- <u> </u>	4	3.19	7.19	3.08
		103	80.97	182.57	1.39
CPL5- <u> </u>	CPL5SA- <u> </u>	5	3.37	7.37	5.00
		129	85.69	187.29	2.25
CPL6- <u> </u>	CPL6SA- <u> </u>	6	3.44	7.44	8.00
		155	87.29	188.89	3.60

Note – Inches, feet and pounds are indicated in bold type. Metric measure is directly below bold type.

* Metric size designator (ANSI C80.1-1994).

Cat. No.	Size	Material	Colour
----------	------	----------	--------

CPL 1 SA -

Blank = Steel = space for color identifier

SA = Aluminum G = Gray 

W = White 

B = Blue 

Catalog No. Example:

CPL1SA-B is a 1" aluminum coupling coated in blue PVC.

Custom colors also available.

Ocal-Blue double-coat split couplings

Join threaded conduit where you can't use a standard coupling



TCC Split Coupling

Split couplings serve as speed unions for cost-effective joining of two separate lengths of threaded conduit. Like other Ocal fittings, they're double coated in urethane and PVC to safeguard your entire conduit system against corrosion.

Product features

- Malleable iron construction
- Nominal .002" (2 mil) blue urethane on both interior and exterior
- Minimum .040" (40 mil) PVC bonded to exterior
- PVC coating in your choice of blue, white and gray standard colors with custom colors available on request
- Stainless steel hardware included separately

Ocal-Blue double-coat split couplings

Cat. No.	Pipe Size (in.)	Metric Size Designator*
TCC1- <u> </u>	1/2	16
TCC2- <u> </u>	3/4	21
TCC3- <u> </u>	1	27
TCC4- <u> </u>	1 1/4	35
TCC5- <u> </u>	1 1/2	41
TCC6- <u> </u>	2	53

* Metric size designator (ANSI C80.1-1994).

Cat. No.	Pipe Size (in.)	Metric Size Designator*
TCC7- <u> </u>	2 1/2	63
TCC8- <u> </u>	3	78
TCC9- <u> </u>	3 1/2	91
TCC10- <u> </u>	4	103
TCC12- <u> </u>	5	129
TCC14- <u> </u>	6	155

* Metric size designator (ANSI C80.1-1994).

Cat. No.	Size	Colour
TCC	1	

 = space for color identifier

G = Gray 

W = White 

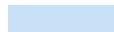
B = Blue 

Custom colors also available.

Note: The use of standard couplings is recommended whenever possible over the use of split couplings, because standard couplings provide better overall corrosion protection.

Ocal-Blue nipples

Speed up your field installations with pre-threaded conduit nipples



Product features

- Made from Ocal PVC-coated steel or aluminum conduit
- Blue urethane coating over threads
- Nominal .002" (2 mil) blue urethane on interior
- Minimum .040" (40 mil) PVC coating on exterior – choose blue, white, gray or custom colors
- Color-coded thread protectors for easy identification of conduit size
- Available in 11 standard lengths – close and 2" to 12" with custom lengths available on request
- Close nipples are coated only in urethane

PVC-coated conduit nipples – steel



Pipe Size (in.) Metric Size*	Nipple Length (in.) (mm)										
	Close	2" 50.8	2½" 63.5	3" 76.2	3½" 88.9	4" 101.6	5" 127.0	6" 152.4	8" 203.2	10" 254.0	12" 304.8
½"	CLNPL1/2- 16	NPL1/2X2- 16	NPL1/2X21/2- 16	NPL1/2X3- 16	NPL1/2X31/2- 16	NPL1/2X4- 16	NPL1/2X5- 16	NPL1/2X6- 16	NPL1/2X8- 16	NPL1/2X10- 16	NPL1/2X12- 16
¾"	CLNPL3/4- 21	NPL3/4X2- 21	NPL3/4X21/2- 21	NPL3/4X3- 21	NPL3/4X31/2- 21	NPL3/4X4- 21	NPL3/4X5- 21	NPL3/4X6- 21	NPL3/4X8- 21	NPL3/4X10- 21	NPL3/4X12- 21
1"	CLNPL1- 27	NPL1X2- 27	NPL1X21/2- 27	NPL1X3- 27	NPL1X31/2- 27	NPL1X4- 27	NPL1X5- 27	NPL1X6- 27	NPL1X8- 27	NPL1X10- 27	NPL1X12- 27
1¼"	CLNPL11/4- 35	NPL11/4X2- 35	NPL11/4X21/2- 35	NPL11/4X3- 35	NPL11/4X31/2- 35	NPL11/4X4- 35	NPL11/4X5- 35	NPL11/4X6- 35	NPL11/4X8- 35	NPL11/4X10- 35	NPL11/4X12- 35
1½"	CLNPL11/2- 41	NPL11/2X2- 41	NPL11/2X21/2- 41	NPL11/2X3- 41	NPL11/2X31/2- 41	NPL11/2X4- 41	NPL11/2X5- 41	NPL11/2X6- 41	NPL11/2X8- 41	NPL11/2X10- 41	NPL11/2X12- 41
2"	CLNPL2- 53	—	NPL2X21/2- 53	NPL2X3- 53	NPL2X31/2- 53	NPL2X4- 53	NPL2X5- 53	NPL2X6- 53	NPL2X8- 53	NPL2X10- 53	NPL2X12- 53
2½"	CLNPL21/2- 63	—	—	—	NPL21/2X31/2- 63	NPL21/2X4- 63	NPL21/2X5- 63	NPL21/2X6- 63	NPL21/2X8- 63	NPL21/2X10- 63	NPL21/2X12- 63
3"	CLNPL3- 78	—	—	—	NPL3X31/2- 78	NPL3X4- 78	NPL3X5- 78	NPL3X6- 78	NPL3X8- 78	NPL3X10- 78	NPL3X12- 78
3½"	CLNPL31/2- 91	—	—	—	—	NPL31/2X4- 91	NPL31/2X5- 91	NPL31/2X6- 91	NPL31/2X8- 91	NPL31/2X10- 91	NPL31/2X12- 91
4"	CLNPL4- 103	—	—	—	—	NPL4X4- 103	NPL4X5- 103	NPL4X6- 103	NPL4X8- 103	NPL4X10- 103	NPL4X12- 103
5"	CLNPL5- 129	—	—	—	—	—	NPL5X5- 129	NPL5X6- 129	NPL5X8- 129	NPL5X10- 129	NPL5X12- 129
6"	CLNPL6- 155	—	—	—	—	—	—	NPL6X5- 155	NPL6X6- 155	NPL6X8- 155	NPL6X10- 155

* Metric size designator (ANSI C80.1-1994).

Cat. No. Size x Length Material Colour

NPL 3/4 x 6 — — — —

Blank = Steel _ = space for color identifier

SA = Aluminum G = Gray

W = White

B = Blue

Catalog No. Example:

NPL3/4X6-G is a ¾" x 6" long steel nipple coated in gray PVC.

Custom colors also available.

Ocal-Blue nipples (continued)



PVC-coated conduit nipples – Aluminum

Pipe Size (in.) Metric Size*	Close	Nipple Length (in.) (mm)										
		2" 50.8	2½" 63.5	3" 76.2	3½" 88.9	4" 101.6	5" 127.0	6" 152.4	8" 203.2	10" 254.0	12" 304.8	
½" 16	CLNPL1/2SA- NPL1/2X2SA- NPL1/2X21/2SA- NPL1/2X3SA- NPL1/2X31/2SA- NPL1/2X4SA- NPL1/2X5SA- NPL1/2X6SA- NPL1/2X8SA- NPL1/2X10SA- NPL1/2X12SA-											
¾" 21	CLNPL3/4SA- NPL3/4X2SA- NPL3/4X21/2SA- NPL3/4X3SA- NPL3/4X31/2SA- NPL3/4X4SA- NPL3/4X5SA- NPL3/4X6SA- NPL3/4X8SA- NPL3/4X10SA- NPL3/4X12SA-											
1" 27	CLNPL1SA- NPL1X2SA- NPL1X21/2SA- NPL1X3SA- NPL1X31/2SA- NPL1X4SA- NPL1X5SA- NPL1X6SA- NPL1X8SA- NPL1X10SA- NPL1X12SA-											
1¼" 35	CLNPL11/4SA- NPL11/4X2SA- NPL11/4X21/2SA- NPL11/4X3SA- NPL11/4X31/2SA- NPL11/4X4SA- NPL11/4X5SA- NPL11/4X6SA- NPL11/4X8SA- NPL11/4X10SA- NPL11/4X12SA-											
1½" 41	CLNPL11/2SA- NPL11/2X2SA- NPL11/2X21/2SA- NPL11/2X3SA- NPL11/2X31/2SA- NPL11/2X4SA- NPL11/2X5SA- NPL11/2X6SA- NPL11/2X8SA- NPL11/2X10SA- NPL11/2X12SA-											
2" 53	CLNPL2SA- NPL2X21/2SA- NPL2X3SA- NPL2X31/2SA- NPL2X4SA- NPL2X5SA- NPL2X6SA- NPL2X8SA- NPL2X10SA- NPL2X12SA-											
2½" 63	CLNPL21/2SA- NPL21/2X31/2SA- NPL21/2X4SA- NPL21/2X5SA- NPL21/2X6SA- NPL21/2X8SA- NPL21/2X10SA- NPL21/2X12SA-											
3" 78	CLNPL3SA- NPL3X31/2SA- NPL3X4SA- NPL3X5SA- NPL3X6SA- NPL3X8SA- NPL3X10SA- NPL3X12SA-											
3½" 91	CLNPL31/2SA- NPL31/2X4SA- NPL31/2X5SA- NPL31/2X6SA- NPL31/2X8SA- NPL31/2X10SA- NPL31/2X12SA-											
4" 103	CLNPL4SA- NPL4X4SA- NPL4X5SA- NPL4X6SA- NPL4X8SA- NPL4X10SA- NPL4X12SA-											
5" 129	CLNPL5SA- NPL5X5SA- NPL5X6SA- NPL5X8SA- NPL5X10SA- NPL5X12SA-											
6" 155	CLNPL6SA- NPL6X5SA- NPL6X6SA- NPL6X8SA- NPL6X10SA- NPL6X12SA-											

* Metric size designator (ANSI C80.1-1994).

Cat. No.	Size x Length	Material	Colour
NPL	3/4 x 6	SA -	Blank
		Blank = Steel _ = space for color identifier	
		SA = Aluminum G = Gray	
		W = White	
		B = Blue	
Catalog No. Example:			
NPL3/4X6-G is a ¾" x 6" long steel nipple coated in gray PVC.			
Custom colors also available.			

Ocal-Blue standard-radius elbows

Factory bent to save wasted time and materials.



Product features



- Fabricated from Ocal PVC-coated conduit
- Standard radii in 30°, 45°, 60° and 90° available for immediate shipment
- Color-coded thread protectors for easy identification of conduit size

Ocal-Blue standard-radius elbows



Cat. No.	Pipe Size		Radius "R"		Offset "C"		Straight End "D"		Unbent Length		Weight Steel only		
	Steel	Aluminium	(in.)	Metric Size Designator*	(in.)	(mm)	(in.)	(mm)	(in.)	(mm)	(lbs)	(kg)	
ELL1/2-_-	ELL1/2-_-SA-	1/2	16	4.00	101.60	6.00	152.40	2.00	50.80	10.28	261.19	0.67	16.95
ELL3/4-_-	ELL3/4-_-SA-	3/4	21	4.50	114.30	6.50	165.10	2.00	50.80	11.07	281.14	0.95	24.07
ELL1-_-	ELL1-_-SA-	1	27	5.75	146.05	8.00	203.20	2.25	57.15	13.53	343.71	1.77	44.97
ELL11/4-_-	ELL11/4-_-SA-	1 1/4	35	7.25	184.15	9.50	241.30	2.25	57.15	15.89	403.56	2.55	64.80
ELL11/2-_-	ELL11/2-_-SA-	1 1/2	41	8.25	209.55	11.00	279.40	2.75	69.85	18.46	468.86	3.98	101.13
ELL2-_-	ELL2-_-SA-	2	53	9.50	241.30	13.00	330.20	3.50	88.90	21.92	556.83	6.33	160.86
ELL21/2-_-	ELL21/2-_-SA-	2 1/2	63	10.50	266.70	14.00	355.60	3.50	88.90	23.49	596.73	9.65	245.09
ELL3-_-	ELL3-_-SA-	3	78	13.00	330.20	16.50	419.10	3.50	88.90	27.42	696.48	15.42	391.77
ELL31/2-_-	ELL31/2-_-SA-	3 1/2	91	15.00	381.00	20.75	527.05	5.75	146.05	35.06	890.57	23.30	591.84
ELL4-_-	ELL4-_-SA-	4	103	16.00	406.40	21.75	552.45	5.75	146.05	36.63	930.47	29.68	753.80
ELL5-_-	ELL5-_-SA-	5	129	24.00	609.60	31.00	787.40	7.00	177.80	51.70	1313.16	60.82	1544.89
ELL6-_-	ELL6-_-SA-	6	155	30.00	762.00	39.00	990.60	9.00	228.60	65.12	1654.15	85.69	2176.51

* Metric size designator (ANSI C80.1-1994).

Cat. No.	Pipe Size	Angle	Material	Colour
ELL	3/4-	-	-	-
		30 = 30°	Blank = Steel	
		45 = 45°	SA = Aluminum	G = Gray 
		60 = 60°		W = White 
		Blank = 90°		B = Blue 
Catalog No. Example:				
ELL3/4X6-G is a 3/4" trade size 90° aluminum elbow coated in white PVC.				Custom colors also available.

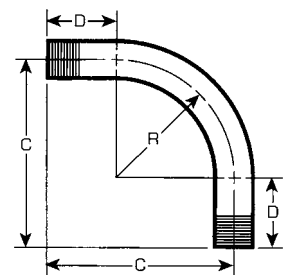

Ocal-Blue large-radius elbows

Choose the size and angle to meet your exact requirements



Product features



- Fabricated from Ocal PVC-coated conduit
- Large radius in 90° available for immediate shipment
- Special radii and angles not listed available upon request
- Color-coded thread protectors for easy identification of conduit size

Ocal-Blue large-radius elbows



Cat. No.	Pipe Size (in.)	Metric Size Designator*	Radius "R"		Offset "C"		Straight End "D"		Unbent Length		
			(in.)	(mm)	(ft/in.)	(mm)	(in.)	(mm)	(ft/in.)	(mm)	
LRELL_X12-_-	LRELL_X12-_-SA-_-	1-2 ¹ / ₂	27-63	12.00	304.80	1' 9"	533.40	9.00	228.60	3' 0"	914.40
LRELL_X15-_-	LRELL_X15-_-SA-_-	1-3	27-78	15.00	381.00	2' 0"	609.60	9.00	228.60	3' 6"	1,066.80
LRELL_X18-_-	LRELL_X18-_-SA-_-	1-4	27-103	18.00	457.20	2' 4"	711.20	10.00	254.00	4' 0"	1,219.20
LRELL_X24-_-	LRELL_X24-_-SA-_-	1-4	27-103	24.00	609.60	2' 11"	889.00	11.00	279.40	4' 11"	1,498.60
LRELL_X30-_-	LRELL_X30-_-SA-_-	1-5	27-129	30.00	762.00	3' 5"	1,041.40	11.00	279.40	5' 9"	1,752.60
LRELL_X36-_-	LRELL_X36-_-SA-_-	1-6	27-155	36.00	914.40	3' 11"	1,193.80	11.00	279.40	6' 6"	1,981.20
LRELL_X42-_-	LRELL_X42-_-SA-_-	1-6	27-155	42.00	1,066.80	4' 6"	1,371.60	12.00	304.80	7' 6"	2,286.00
LRELL_X48-_-	LRELL_X48-_-SA-_-	1-6	27-155	48.00	1,219.20	5' 0"	1,524.00	12.00	304.80	8' 6"	2,590.80
LRELL_X60-_-	LRELL_X60-_-SA-_-	2 ¹ / ₂ -6	63-155	60.00	1,524.00	6' 0"	1,828.80	12.00	304.80	9' 10"	2,997.20

* Metric size designator (ANSI C80.1-1994).

Cat. No.	Pipe Size	Radius	Angle	Material	Colour
LRELL X 12- - -					
1 = 1		30 = 30°		Blank = Steel	
2 = 2		45 = 45°		SA = Aluminum	G = Gray 
		60 = 60°			W = White 
		Blank = 90°			B = Blue 

Catalog No. Example:
LRELL3X18-45-G is a 3" trade size steel elbow with radius of 18" and an angle of 45°, coated in gray PVC.

Custom colors also available.

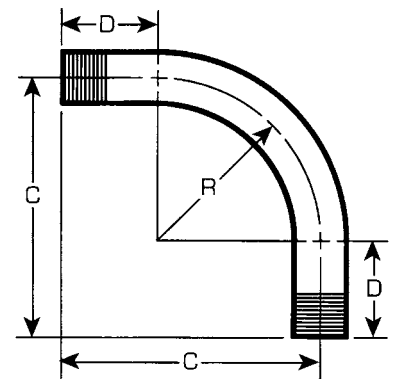

Ocal PVC-coated beam clamps and U-bolts

PVC coating evenly molded around saddle prevents exposure of metal – an Ocal exclusive



Parallel (PAR)



Edge (EC)

Product features

- Beam clamps support and attach conduit runs to structural beams
- Molded right-angle beam clamps and U-bolts provide extra protection
- Encapsulated, hex-shaped nuts fit standard wrenches
- Stainless steel hardware included
- Parallel (PAR) and edge (EC) clamps feature nominal .015" (15 mil) PVC coating for corrosion protection
- Right-Angle clamps (RA) and U-Bolts (UB) feature nominal .040" (40 mil) PVC coating for corrosion protection

PVC-coated beam clamps

Cat. No.	Parallel	Edge	Pipe Size (in.)	Metric Size Designator*
RA1/2- <u> </u>	PAR1/2- <u> </u>	EC1/2- <u> </u>	1/2	16
RA3/4- <u> </u>	PAR3/4- <u> </u>	EC3/4- <u> </u>	3/4	21
RA1- <u> </u>	PAR1- <u> </u>	EC1- <u> </u>	1	27
RA1-1/4- <u> </u>	PAR1-1/4- <u> </u>	EC1-1/4- <u> </u>	1 1/4	35
RA1-1/2- <u> </u>	PAR1-1/2- <u> </u>	EC1-1/2- <u> </u>	1 1/2	41
RA2- <u> </u>	PAR2- <u> </u>	EC2- <u> </u>	2	53
RA2-1/2- <u> </u>	PAR2-1/2- <u> </u>	—	2 1/2	63
RA3- <u> </u>	PAR3- <u> </u>	—	3	78
RA3-1/2- <u> </u>	PAR3-1/2- <u> </u>	—	3 1/2	91
RA4- <u> </u>	PAR4- <u> </u>	—	4	103

Metric size designator (ANSI C80.1-1994).

PVC-coated U-bolts

Cat. No.	Pipe Size (in.)	Metric Size Designator*	"A" Dimension	
			(in.)	(mm)
UB1/2- <u> </u>	1/2	16	1.38	34.93
UB3/4- <u> </u>	3/4	21	1.56	39.69
UB1- <u> </u>	1	27	1.84	46.83
UB1-1/4- <u> </u>	1 1/4	35	2.19	55.56
UB1-1/2- <u> </u>	1 1/2	41	2.50	63.50
UB2- <u> </u>	2	53	2.97	75.41
UB2-1/2- <u> </u>	2 1/2	63	3.47	88.11
UB3- <u> </u>	3	78	4.09	103.98
UB3-1/2- <u> </u>	3 1/2	91	4.59	116.68
UB4- <u> </u>	4	103	5.09	129.38
UB5- <u> </u>	5	129	6.63	168.28
UB6- <u> </u>	6	155	8.00	203.20

Metric size designator (ANSI C80.1-1994).

Cat. No.	Colour
----------	--------

RA1-

 = space for color identifier

G = Gray 

W = White 

B = Blue 

Custom colors also available.



Right Angle (RA)

Cat. No.	Size	Colour
----------	------	--------

UB 1-

 = space for color identifier

G = Gray 

W = White 

B = Blue 

Custom colors also available.

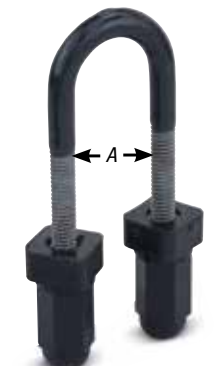

U-Bolt (UB)

Pipe Straps

Support conduit on walls and structures



Fig. 1



Fig. 2



Fig. 3

One-hole PV coated pipe ptrap



Fig. 4



Fig. 5

Two-hole PVC-coated pipe strap

Product features

- Available in malleable iron/stamped steel with nominal .015" (15 mil) PVC coating in your choice of blue, white or gray or in 303 stainless steel
- Choose one- or two-hole versions
- Sized to allow for the extra thickness of the PVC coating

PVC-coated pipe straps

Cat. No.	Pipe Size (in.)	Figure
One-Hole malleable iron		
1277CR*	3/4	1
1278CR*	1	1
1HS1C-G**	1	2
1HMS1-1/4-G**	1 1/4	3
1280CR*	1 1/2	1
1HMS2-C_	2	4
1HMS2-1/2-C_	2 1/2	4
1HMS3-C_	3	4
1HMS4-C_	4	4
Two holes malleable iron		
2HMS2-C_	2	5
2HMS2-1/2-C_	2 1/2	5
2HMS3-C_	3	5
2HMS4-C_	4	5

* CSA certified

** UL non applicable

Cat. No.	Colour
----------	--------

_ = space for color identifier

G = Gray 

W = White 

B = Blue 

Custom colors also available.

Ocal PVC-coated clamp-back spacers

Use as spacers with one-hole pipe straps



Product features

- Provides space for air flow between conduit and mounting surface
- Nominal .015" (15 mil) PVC coating for corrosion protection

Ocal PVC-coated clamp-back spacers

Cat. No.	Pipe Size (in.)	Metric Size Designator*
CB1/2- _	1/2	16
CB3/4- _	3/4	21
CB1- _	1	27
CB1-1/4- _	1 1/4	35
CB1-1/2- _	1 1/2	41
CB2- _	2	53
CB2-1/2- _	2 1/2	63
CB3- _	3	78
CB3-1/2- _	3 1/2	91
CB4- _	4	103

Cat. No.	Colour
----------	--------

CB1-

_ = space for color identifier

G = Gray 

W = White 

B = Blue 

Custom colors also available.

Ocal-Blue double-coat conduit bodies

Easy access for pulling, splicing, mounting and maintenance



With Ocal-Blue double-coat conduit bodies, you can connect sections of conduit – with or without 90° bends – and provide easy access for wire pulling, making splices in branch conductors and maintenance and future system changes. Conduit bodies can also serve as mounting outlets for wiring devices and lighting fixtures.

- 01 3/4" T Form 8 conduit body and cover
- 02 3/4" X Form 7 conduit body and cover
- 03 2 1/2" LB Form 8 conduit body and cover
- 04 2 1/2" LB Form 7 conduit body and cover
- 05 3/4" LB Mark 9 conduit body and cover

Product features

- Type 4X Form 8 (1/2"-2") conduit bodies have injection-molded PVC-coated cover with integral O-ring seal
- Flat surface molded on conduit body seals with molded flange on cover on 2 1/2"-4" Form 8 and all Form 7
- Available in Form 7 and Form 8 ferrous as well as Mark 9 and Form 7 aluminum
- All Ocal-Blue conduit bodies offer double corrosion protection – both bodies and covers coated inside and out with a nominal .002" (2 mil) blue urethane, then exterior coated with a nominal .040" (40 mil) PVC
- PVC coating in your choice of blue, gray or white with custom colors available
- All threaded hubs fitted with pressure-sealing sleeves

- Conduit bodies ship complete with covers and encapsulated stainless steel screws
- Covers also sold separately for replacement or retrofit purposes

Cat. No.	Material	Colour
LB27-		
	Blank = Ferrous	_ = space for color identifier
	SA = Aluminum	G = Gray 
		W = White 
		B = Blue 
Catalog No. Example: LB27-W is a 3/4" LB ferrous conduit body and cover coated in white PVC.		
Custom colors also available.		



01



02



03



04



05











Ocal-Blue conduit bodies

Quick reference guide



Ocal-Blue conduit bodies and covers - quick reference

Up to and including 2 in.

		Size (Inch and Metric Size Designator*)									
Shape	Style	1/2" 16	3/4" 21	1" 27	1 1/4" 35	1 1/2" 41	2" 53	2 1/2" 63	3" 78	3 1/2" 91	4" 103
Ocal-Blue Conduit bodies											
	Form 7	C17- <u> </u>	C27- <u> </u>	C37- <u> </u>	C47- <u> </u>	C57- <u> </u>	C67- <u> </u>	C77- <u> </u>	C87- <u> </u>	—	—
	Form 8	C18-4X- <u> </u>	C28-4X- <u> </u>	C38-4X- <u> </u>	C448-4X- <u> </u>	C58-4X- <u> </u>	C68-4X- <u> </u>	C78- <u> </u>	C88- <u> </u>	—	—
	Mark 9	C19- <u> </u>	C29- <u> </u>	C39- <u> </u>	C49- <u> </u>	C59- <u> </u>	C69- <u> </u>	C789- <u> </u>	C889- <u> </u>	C989- <u> </u>	C1089- <u> </u>
	Form 7 Aluminum	C17SA- <u> </u>	C27SA- <u> </u>	C37SA- <u> </u>	C47SA- <u> </u>	C57SA- <u> </u>	C67SA- <u> </u>	C77SA- <u> </u>	C87SA- <u> </u>	—	—
	Form 7	LU17- <u> </u>	LU27- <u> </u>	LU37- <u> </u>	LU47- <u> </u>	LU57- <u> </u>	LU67- <u> </u>	—	—	—	—
	Form 8	LU18-4X- <u> </u>	LU28-4X- <u> </u>	LU38-4X- <u> </u>	LU448-4X- <u> </u>	LU58-4X- <u> </u>	LU68-4X- <u> </u>	—	—	—	—
	Form 7	LB17- <u> </u>	LB27- <u> </u>	LB37- <u> </u>	LB47- <u> </u>	LB57- <u> </u>	LB67- <u> </u>	LB777- <u> </u>	LB87- <u> </u>	LB97- <u> </u>	LB107- <u> </u>
	Form 8	LB18-4X- <u> </u>	LB28-4X- <u> </u>	LB38-4X- <u> </u>	LB448-4X- <u> </u>	LB58-4X- <u> </u>	LB68-4X- <u> </u>	LB78- <u> </u>	LB888- <u> </u>	LB98- <u> </u>	LB108- <u> </u>
	Mark 9	LB19- <u> </u>	LB29- <u> </u>	LB39- <u> </u>	LB49- <u> </u>	LB59- <u> </u>	LB69- <u> </u>	LB789- <u> </u>	LB889- <u> </u>	LB989- <u> </u>	LB1089- <u> </u>
	Form 7 Aluminum	LB17SA- <u> </u>	LB27SA- <u> </u>	LB37SA- <u> </u>	LB47SA- <u> </u>	LB57SA- <u> </u>	LB67SA- <u> </u>	LB777SA- <u> </u>	LB87SA- <u> </u>	LB97SA- <u> </u>	LB107SA- <u> </u>
	Form 7	LL17- <u> </u>	LL27- <u> </u>	LL37- <u> </u>	LL47- <u> </u>	LL57- <u> </u>	LL67- <u> </u>	LL777- <u> </u>	LL87- <u> </u>	LL97- <u> </u>	LL107- <u> </u>
	Form 8	LL18-4X- <u> </u>	LL28-4X- <u> </u>	LL38-4X- <u> </u>	LL448-4X- <u> </u>	LL58-4X- <u> </u>	LL68-4X- <u> </u>	LL78- <u> </u>	LL888- <u> </u>	—	—
	Mark 9	LL19- <u> </u>	LL29- <u> </u>	LL39- <u> </u>	LL49- <u> </u>	LL59- <u> </u>	LL69- <u> </u>	LL789- <u> </u>	LL889- <u> </u>	LL989- <u> </u>	LL1089- <u> </u>
	Form 7 Aluminum	LL17SA- <u> </u>	LL27SA- <u> </u>	LL37SA- <u> </u>	LL47SA- <u> </u>	LL57SA- <u> </u>	LL67SA- <u> </u>	LL777SA- <u> </u>	LL87SA- <u> </u>	LL97SA- <u> </u>	LL107SA- <u> </u>
	Form 7	LR17- <u> </u>	LR27- <u> </u>	LR37- <u> </u>	LR47- <u> </u>	LR57- <u> </u>	LR67- <u> </u>	LR777- <u> </u>	LR87- <u> </u>	LR97- <u> </u>	LR107- <u> </u>
	Form 8	LR18-4X- <u> </u>	LR28-4X- <u> </u>	LR38-4X- <u> </u>	LR448-4X- <u> </u>	LR58-4X- <u> </u>	LR68-4X- <u> </u>	LR78- <u> </u>	LR888- <u> </u>	—	—
	Mark 9	LR19- <u> </u>	LR29- <u> </u>	LR39- <u> </u>	LR49- <u> </u>	LR59- <u> </u>	LR69- <u> </u>	LR789- <u> </u>	LR889- <u> </u>	LR989- <u> </u>	LR1089- <u> </u>
	Form 7 Aluminum	LR17SA- <u> </u>	LR27SA- <u> </u>	LR37SA- <u> </u>	LR47SA- <u> </u>	LR57SA- <u> </u>	LR67SA- <u> </u>	LR777SA- <u> </u>	LR87SA- <u> </u>	LR97SA- <u> </u>	LR107SA- <u> </u>
	Form 7	T17- <u> </u>	T27- <u> </u>	T37- <u> </u>	T47- <u> </u>	T57- <u> </u>	T67- <u> </u>	T77- <u> </u>	T87- <u> </u>	T97- <u> </u>	T107- <u> </u>
	Form 8	T18-4X- <u> </u>	T28-4X- <u> </u>	T38-4X- <u> </u>	T448-4X- <u> </u>	T58-4X- <u> </u>	T68-4X- <u> </u>	T78- <u> </u>	T88- <u> </u>	—	—
	Mark 9	T19- <u> </u>	T29- <u> </u>	T39- <u> </u>	T49- <u> </u>	T59- <u> </u>	T69- <u> </u>	T789- <u> </u>	T889- <u> </u>	T989- <u> </u>	T1089- <u> </u>
	Form 7 Aluminum	T17SA- <u> </u>	T27SA- <u> </u>	T37SA- <u> </u>	T47SA- <u> </u>	T57SA- <u> </u>	T67SA- <u> </u>	T77SA- <u> </u>	T87SA- <u> </u>	T97SA- <u> </u>	T107SA- <u> </u>
	Form 7	TB17- <u> </u>	TB27- <u> </u>	TB37- <u> </u>	TB47- <u> </u>	TB57- <u> </u>	TB67- <u> </u>	—	—	—	—
	Form 8	TB18-4X- <u> </u>	TB28-4X- <u> </u>	TB38-4X- <u> </u>	TB448-4X- <u> </u>	TB58-4X- <u> </u>	TB68-4X- <u> </u>	—	—	—	—
	Mark 9	TB19- <u> </u>	TB29- <u> </u>	TB39- <u> </u>	TB49- <u> </u>	—	—	—	—	—	—
	Form 7 Aluminum	TB17SA- <u> </u>	TB27SA- <u> </u>	TB37SA- <u> </u>	TB47SA- <u> </u>	TB57SA- <u> </u>	TB67SA- <u> </u>	—	—	—	—
	Form 7	X17- <u> </u>	X27- <u> </u>	X37- <u> </u>	X47- <u> </u>	X57- <u> </u>	X67- <u> </u>	—	—	—	—
	Form 8	X18-4X- <u> </u>	X28-4X- <u> </u>	X38-4X- <u> </u>	X448-4X- <u> </u>	X58-4X- <u> </u>	X68-4X- <u> </u>	—	—	—	—
	Mark 9	X19- <u> </u>	X29- <u> </u>	X39- <u> </u>	—	—	—	—	—	—	—
	Form 7 Aluminum	X17SA- <u> </u>	X27SA- <u> </u>	X37SA- <u> </u>	X47SA- <u> </u>	X57SA- <u> </u>	X67SA- <u> </u>	—	—	—	—
Note - Fittings shown uncoated											
Ocal-Blue conduit body covers											
	Form 7	170F- <u> </u>	270F- <u> </u>	370F- <u> </u>	470F- <u> </u>	570F- <u> </u>	670F- <u> </u>	870F- <u> </u>	870F- <u> </u>	970F- <u> </u>	970F- <u> </u>
	Form 8	180F-4X- <u> </u>	280F-4X- <u> </u>	380F-4X- <u> </u>	480F-4X- <u> </u>	580F-4X- <u> </u>	680F-4X- <u> </u>	880F- <u> </u>	880F- <u> </u>	980F- <u> </u>	980F- <u> </u>
	Mark 9	190- <u> </u>	290- <u> </u>	390- <u> </u>	490- <u> </u>	590- <u> </u>	690- <u> </u>	889- <u> </u>	889- <u> </u>	989- <u> </u>	989- <u> </u>
	Form 7 Aluminum	170SA- <u> </u>	270SA- <u> </u>	370SA- <u> </u>	470SA- <u> </u>	570SA- <u> </u>	670SA- <u> </u>	870SA- <u> </u>	870SA- <u> </u>	970SA- <u> </u>	970SA- <u> </u>

* Metric size designator (ANSI C80.1-1994). PVC coated "OCAL-BLUE" conduit bodies with covers for threaded rigid conduit series C, LB, LL, LR, T, TB and X with supports 28-4X, 38-4X, 448-4X, 48-4X and 68-4X. Type 4X ratings in 1/2 in. (16) to 2 in. (53) trade size.

Ocal-Blue conduit bodies

With covers – C shape

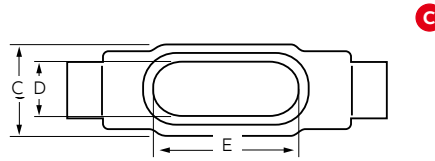
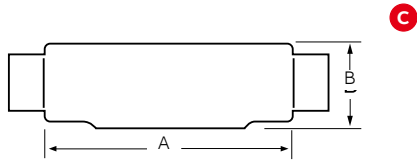

Up to and including 2 in.

C Form 7 Ferrous conduit bodies with covers

Product Code	Hub Size*	Dimensions (in. and mm)**					Vol. Cap. (cu.in./cu/cm.)
		A	B	C	D	E	
C17-	1/2"	5.45	1.40	1.45	0.95	3.20	4.00
	16	138.43	35.56	36.83	24.13	81.28	65.55
C27-	3/4"	6.05	1.60	1.65	1.15	3.80	6.60
	21	153.67	40.64	41.91	29.21	96.52	108.15
C37-	1"	6.75	1.90	1.80	1.35	4.55	10.60
	27	171.45	48.26	45.72	34.29	115.57	173.70
C47-	1 1/4"	7.30	2.30	2.20	1.80	5.00	18.80
	35	185.42	58.42	55.88	45.72	127.00	308.08
C57-	1 1/2"	8.60	2.60	2.45	2.05	5.45	26.40
	41	218.44	66.04	62.23	52.07	138.43	432.62
C67-	2"	9.50	3.20	3.05	2.45	6.40	51.00
	53	241.30	81.28	77.47	62.23	162.56	835.74
C77-	2 1/2"	12.10	3.65	4.25	3.60	8.40	102.00
	63	307.34	92.71	107.95	91.44	213.36	1,671.48
C87-	3"	12.10	4.40	4.25	3.60	8.40	132.00
	78	307.34	111.76	107.95	91.44	213.36	2,163.09

C Mark 9 Aluminum conduit bodies with covers

Product Code	Hub Size*	Dimensions (in. and mm)**					Vol. Cap. (cu.in./cu/cm.)
		A	B	C	D	E	
C19-	1/2"	5.00	1.38	1.38	1.19	3.31	—
	16	127.00	35.05	35.05	30.23	84.07	—
C29-	3/4"	5.69	1.63	1.56	1.38	3.94	—
	21	144.53	41.4	39.62	35.05	100.08	—
C39-	1"	6.59	1.88	1.75	1.50	4.56	—
	27	167.39	47.75	44.45	38.10	115.82	—
C49-	1 1/4"	7.50	2.50	2.19	1.94	5.31	—
	35	190.50	63.5	55.63	49.28	134.87	—
C59-	1 1/2"	8.25	2.75	2.50	2.25	6.00	—
	41	209.55	69.85	63.5	57.15	152.40	—
C69-	2"	10.50	3.44	3.19	2.88	8.06	—
	53	266.70	87.38	81.03	73.15	204.72	—
C789-	2 1/2"	15.63	4.44	5.00	4.25	10.88	—
	63	397.00	112.78	127.00	107.95	276.35	—
C889-	3"	15.63	4.81	5.00	4.25	10.88	—
	78	397.00	122.17	127.00	107.95	276.35	—
C989-	3 1/2"	18.75	5.69	6.25	5.44	13.44	—
	91	476.25	144.53	158.75	138.18	341.38	—
C1089-	4"	18.75	5.94	6.25	5.44	13.44	—
	103	476.25	150.88	158.75	138.18	341.38	—

C Form 8 Ferrous conduit bodies with covers

Product Code	Hub Size*	Dimensions (in. and mm)**					Vol. Cap. (cu.in./cu/cm.)
		A	B	C	D	E	
C18-4X-	1/2"	5.53	1.44	1.38	1.00	3.31	4.90
	16	140.49	36.51	34.93	25.40	84.14	80.30
C28-4X-	3/4"	6.28	1.53	1.19	1.19	3.94	8.00
	21	159.54	38.89	30.16	30.16	100.01	131.10
C38-4X-	1"	7.31	1.94	1.75	1.38	4.56	13.00
	27	185.74	49.21	44.45	34.93	115.89	213.03
C448-4X-	1 1/4"	8.50	2.38	2.19	1.75	5.31	23.50
	35	215.90	60.33	55.56	44.45	134.94	385.10
C58-4X-	1 1/2"	10.38	2.78	2.75	2.13	6.50	45.00
	41	263.53	70.64	69.85	53.98	165.10	737.42
C68-4X-	2"	12.25	3.56	3.75	3.00	8.56	88.00
	53	311.15	90.49	95.25	76.20	217.49	1,442.06
C78-	2 1/2"	15.63	4.44	5.00	4.25	10.88	110.00
	63	396.88	112.71	127.00	107.95	276.23	1,802.58
C88-	3"	15.63	4.81	5.00	4.25	10.88	110.00
	78	396.88	122.24	127.00	107.95	276.23	1,802.58

C Form 7 Aluminum conduit bodies with covers

Product Code	Hub Size*	Dimensions (in. and mm)**					Vol. Cap. (cu.in./cu/cm.)
		A	B	C	D	E	
C17SA-	1/2"	5.45	1.40	1.45	0.95	3.20	4.00
	16	138.43	35.56	36.83	24.13	81.28	65.55
C27SA-	3/4"	6.05	1.60	1.65	1.15	3.80	6.60
	21	153.67	40.64	41.91	29.21	96.52	108.15
C37SA-	1"	6.75	1.90	1.80	1.35	4.55	10.60
	27	171.45	48.26	45.72	34.29	115.57	173.70
C47SA-	1 1/4"	7.30	2.30	2.20	1.80	5.00	18.80
	35	185.42	58.42	55.88	45.72	127.00	308.08
C57SA-	1 1/2"	8.60	2.60	2.45	2.05	5.45	26.40
	41	218.44	66.04	62.23	52.07	138.43	432.62
C67SA-	2"	9.50	3.20	3.05	2.45	6.40	51.00
	53	241.30	81.28	77.47	62.23	162.56	835.74
C77SA-	2 1/2"	12.10	3.65	4.25	3.60	8.40	102.00
	63	307.34	92.71	107.95	91.44	213.36	1,671.48
C87SA-	3"	12.10	4.40	4.25	3.60	8.40	132.00
	78	307.34	111.76	107.95	91.44	213.36	2,163.09

* Metric size designator (ANSI C80.1-1994).

** Dimensions shown are for uncoated conduit bodies.

Ocal-Blue conduit bodies

With covers – LB shape

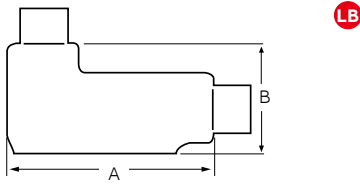

LB Form 7 Ferrous conduit bodies with covers

Product Code	Hub Size*	Dimensions (in. and mm)**					Vol. Cap. (cu.in./cu.cm.)
		A	B	C	D	E	
LB17-	1/2"	4.60	2.20	1.35	0.95	3.20	4.00
	16	116.84	55.88	34.29	24.13	81.28	65.55
LB27-	3/4"	5.25	2.40	1.65	1.15	3.80	6.60
	21	133.35	60.96	41.91	29.21	96.52	108.15
LB37-	1"	6.00	2.65	1.80	1.35	4.55	10.60
	27	152.40	67.31	45.72	34.29	115.57	173.70
LB47-	1 1/4"	6.45	3.20	2.20	1.80	5.00	18.80
	35	163.83	81.28	55.88	45.72	127.00	308.08
LB57-	1 1/2"	7.25	3.90	2.45	2.05	5.45	26.40
	41	184.15	99.06	62.23	52.07	138.43	432.62
LB67-	2"	8.30	4.45	3.10	2.45	6.40	51.00
	53	210.82	113.03	78.74	62.23	162.56	835.74
LB777-	2 1/2"	10.55	5.20	4.25	3.60	8.40	102.00
	63	267.97	132.08	107.95	91.44	213.36	1,671.48
LB87-	3"	10.55	5.95	4.25	3.60	8.40	132.00
	78	267.97	151.13	107.95	91.44	213.36	2,163.09
LB97-	3 1/2"	12.85	6.70	5.25	4.55	10.25	210.00
	91	326.39	170.18	133.35	115.57	260.35	3,441.28
LB107-	4"	12.85	7.20	5.25	4.55	10.25	243.00
	103	326.39	182.88	133.35	115.57	260.35	3,982.06

LB Form 8 Ferrous conduit bodies with covers

Product Code	Hub Size*	Dimensions (in. and mm)**					Vol. Cap. (cu.in./cu.cm.)
		A	B	C	D	E	
LB18-4X-	1/2"	4.94	2.22	1.38	1.00	3.31	4.90
	16	125.41	56.36	34.93	25.40	84.14	80.30
LB28-4X-	3/4"	5.56	2.44	1.56	1.19	3.31	8.00
	21	141.29	61.93	39.69	30.16	84.14	131.10
LB38-4X-	1"	6.50	2.81	1.75	1.38	4.56	13.00
	27	165.10	71.45	44.45	34.93	115.89	213.03
LB448-4X-	1 1/4"	7.53	3.34	2.19	1.75	5.31	23.50
	35	191.29	84.93	55.56	44.45	134.94	385.10
LB58-4X-	1 1/2"	9.13	4.03	2.75	2.13	6.50	45.00
	41	231.78	102.39	69.85	53.98	165.10	737.42
LB68-4X-	2"	11.00	4.41	3.75	3.00	8.56	88.00
	53	279.40	111.92	95.25	76.20	217.49	1,442.06
LB78-	2 1/2"	13.94	6.13	5.00	4.25	10.88	110.00
	63	354.01	155.58	127.00	107.95	276.23	1,802.58
LB888-	3"	13.94	6.50	5.00	4.25	10.88	110.00
	78	354.01	165.10	127.00	107.95	276.23	1,802.58
LB98-	3 1/2"	16.88	7.56	6.25	5.44	13.44	250.00
	91	428.63	192.09	158.75	138.11	341.31	4,096.77
LB108-	4"	16.88	7.81	6.25	5.44	13.44	250.00
	103	428.63	198.44	158.75	138.11	341.31	4,096.77

* Metric size designator (ANSI C80.1-1994).

** Dimensions shown are for uncoated conduit bodies.

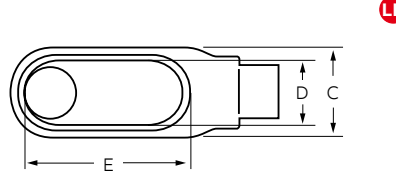

LB Mark 9 Aluminum conduit bodies with covers

Product Code	Hub Size*	Dimensions (in. and mm)**					Vol. Cap. (cu.in./cu.cm.)
		A	B	C	D	E	
LB19-	1/2"	4.59	2.13	1.38	1.19	3.31	—
	16	116.68	53.98	34.93	30.16	84.14	—
LB29-	3/4"	5.25	2.41	1.56	1.38	3.94	—
	21	133.35	61.12	39.69	34.93	100.01	—
LB39-	1"	6.09	2.84	1.75	1.50	4.56	—
	27	154.78	72.23	44.45	38.1	115.89	—
LB49-	1 1/4"	7.03	3.47	2.19	1.94	5.31	—
	35	178.59	88.11	55.56	49.21	134.94	—
LB59-	1 1/2"	7.75	3.75	2.50	2.25	6.00	—
	41	196.85	95.25	63.50	57.15	152.40	—
LB69-	2"	10.03	4.47	3.19	2.88	8.06	—
	53	254.79	113.51	80.96	73.03	204.79	—
LB789-	2 1/2"	13.94	6.13	5.00	4.25	10.88	—
	63	354.01	155.58	127.00	107.95	276.23	—
LB889-	3"	13.94	6.50	5.00	4.25	10.88	—
	78	354.01	165.10	127.00	107.95	276.23	—
LB989-	3 1/2"	16.88	7.56	6.25	5.44	13.44	—
	91	428.63	192.09	158.75	138.11	341.31	—
LB1089-	4"	16.88	7.81	6.25	5.44	13.44	—
	103	428.63	198.44	158.75	138.11	341.31	—

LB Form 7 Aluminum conduit bodies with covers

Product Code	Hub Size*	Dimensions (in. and mm)**					Vol. Cap. (cu.in./cu.cm.)
		A	B	C	D	E	
LB17SA-	1/2"	4.60	2.20	1.35	0.95	3.20	4.00
	16	116.84	55.88	34.29	24.13	81.28	65.55
LB27SA-	3/4"	5.25	2.40	1.65	1.15	3.80	6.60
	21	133.35	60.96	41.91	29.21	96.52	108.15
LB37SA-	1"	6.00	2.65	1.80	1.35	4.55	10.60
	27	152.40	67.31	45.72	34.29	115.57	173.70
LB47SA-	1 1/4"	6.45	3.20	2.20	1.80	5.00	18.80
	35	163.83	81.28	55.88	45.72	127.00	308.08
LB57SA-	1 1/2"	7.25	3.90	2.45	2.05	5.45	26.40
	41	184.15	99.06	62.23	52.07	138.43	432.62
LB67SA-	2"	8.30	4.45	3.10	2.45	6.40	51.00
	53	210.82	113.03	78.74	62.23	162.56	835.74
LB777SA-	2 1/2"	10.55	5.20	4.25	3.60	8.40	102.00
	63	267.97	132.08	107.95	91.44	213.36	1,671.48
LB87SA-	3"	10.55	5.95	4.25	3.60	8.40	132.00
	78	267.97	151.13	107.95	91.44	213.36	2,163.09
LB97SA-	3 1/2"	12.85	6.70	5.25	4.55	10.25	210.00
	91	326.39	170.18	133.35	115.57	260.35	3,441.28
LB107SA-	4"	12.85	7.20	5.25	4.55	10.25	243.00
	103	326.39	182.88	133.35	115.57	260.35	3,982.06



Ocal-Blue conduit bodies

With covers – LL shape

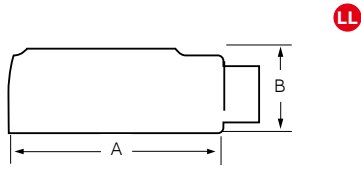

LL Form 7 Ferrous conduit bodies with covers

Product Code	Hub Size*	Dimensions (in. and mm)**					Vol. Cap. (cu.in./cu/cm.)
		A	B	C	D	E	
LL17-	1/2"	4.60	1.40	1.45	0.95	3.20	4.00
	16	116.84	35.56	36.83	24.13	81.28	65.55
LL27-	3/4"	5.25	1.60	1.65	1.15	3.80	6.60
	21	133.35	40.64	41.91	29.21	96.52	108.15
LL37-	1"	6.00	1.90	2.60	1.35	4.55	10.60
	27	152.40	48.26	66.04	34.29	115.57	173.70
LL47-	1 1/4"	6.45	2.30	3.05	1.80	5.00	18.60
	35	163.83	58.42	77.47	45.72	127.00	304.80
LL57-	1 1/2"	7.90	2.60	3.80	2.05	5.45	26.40
	41	200.66	66.04	96.52	52.07	138.43	432.62
LL67-	2"	8.30	3.20	4.25	2.45	6.40	51.00
	53	210.82	81.28	107.95	62.23	162.56	835.74
LL777-	2 1/2"	10.55	3.65	5.80	3.60	8.40	102.00
	63	267.97	92.71	147.32	91.44	213.36	1671.48
LL87-	3"	10.55	4.40	5.80	3.60	8.40	132.00
	78	267.97	111.76	147.32	91.44	213.36	2,163.09
LL97-	3 1/2"	12.85	4.90	7.03	4.55	10.25	210.00
	91	326.39	124.46	178.56	115.57	260.35	3,441.28
LL107-	4"	12.85	5.40	7.03	4.55	10.25	243.00
	103	326.39	137.16	178.56	115.57	260.35	3,982.06

LL Form 8 Ferrous conduit bodies with covers

Product Code	Hub Size*	Dimensions (in. and mm)**					Vol. Cap. (cu.in./cu/cm.)
		A	B	C	D	E	
LL18-4X-	1/2"	4.94	1.44	2.16	1.00	3.31	4.90
	16	125.41	36.51	54.77	25.40	84.14	80.30
LL28-4X-	3/4"	5.56	1.69	2.31	1.19	3.94	8.00
	21	141.29	42.86	58.74	30.16	100.01	131.10
LL38-4X-	1"	6.47	1.94	2.63	1.38	4.56	13.00
	27	164.31	49.21	66.68	34.93	115.89	213.03
LL448-4X-	1 1/4"	7.53	2.38	3.16	1.75	5.31	23.50
	35	191.29	60.33	80.17	44.45	134.94	385.10
LL58-4X-	1 1/2"	9.13	2.78	4.00	2.13	6.50	45.00
	41	231.78	70.64	101.60	53.98	165.10	737.42
LL68-4X-	2"	11.00	3.56	5.00	3.00	8.56	88.00
	53	279.40	90.49	127.00	76.20	217.49	1,442.06
LL78-	2 1/2"	13.94	4.44	6.69	4.25	10.88	110.00
	63	354.01	112.71	169.86	107.95	276.23	1,802.58
LL888-	3"	13.94	4.81	6.69	4.25	10.88	110.00
	78	354.01	122.24	169.86	107.95	276.23	1,802.58

* Metric size designator (ANSI C80.1-1994).

** Dimensions shown are for uncoated conduit bodies.

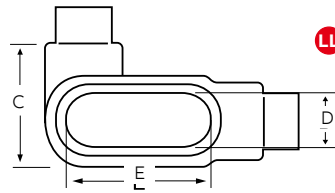

LL Mark 9 Aluminum conduit bodies with covers

Product Code	Hub Size*	Dimensions (in. and mm)**					Vol. Cap. (cu.in./cu/cm.)
		A	B	C	D	E	
LL19-	1/2"	4.59	1.38	2.13	1.19	3.31	—
	16	116.68	34.93	53.98	30.16	84.14	—
LL29-	3/4"	5.25	1.63	2.38	1.38	3.94	—
	21	133.35	41.28	60.33	34.93	100.01	—
LL39-	1"	6.09	1.88	2.63	1.50	4.56	—
	27	154.78	47.63	66.68	38.10	115.89	—
LL49-	1 1/4"	7.03	2.50	3.09	1.94	5.31	—
	35	178.59	63.50	78.58	49.21	134.94	—
LL59-	1 1/2"	7.75	2.75	3.44	2.25	6.00	—
	41	196.85	69.85	87.31	57.15	152.40	—
LL69-	2"	10.03	3.44	4.13	2.88	8.06	—
	53	254.79	87.31	104.78	73.03	204.79	—
LL789-	2 1/2"	13.94	4.44	6.69	4.25	10.88	—
	63	354.01	112.71	169.86	107.95	276.23	—
LL889-	3"	13.94	4.81	6.69	4.25	10.88	—
	78	354.08	122.24	169.93	107.95	276.35	—
LL989-	3 1/2"	16.88	5.69	8.13	5.44	13.44	—
	91	428.63	144.46	206.38	138.11	341.31	—
LL1089-	4"	16.88	5.94	8.13	5.44	13.44	—
	103	428.63	150.81	206.38	138.11	341.31	—

LL Form 7 Aluminum conduit bodies with covers

Product Code	Hub Size*	Dimensions (in. and mm)**					Vol. Cap. (cu.in./cu/cm.)
		A	B	C	D	E	
LL17SA-	1/2"	4.60	1.40	1.45	0.95	3.20	4.00
	16	116.84	35.56	36.83	24.13	81.28	65.55
LL27SA-	3/4"	5.25	1.60	1.65	1.15	3.80	6.60
	21	133.35	40.64	41.91	29.21	96.52	108.15
LL37SA-	1"	6.00	1.90	2.60	1.35	4.55	10.60
	27	152.40	48.26	66.04	34.29	115.57	173.7
LL47SA-	1 1/4"	6.45	2.30	3.05	1.80	5.00	18.60
	35	163.83	58.42	77.47	45.72	127.00	304.8
LL57SA-	1 1/2"	7.90	2.60	3.80	2.05	5.45	26.40
	41	200.66	66.04	96.52	52.07	138.43	432.62
LL67SA-	2"	8.30	3.20	4.25	2.45	6.40	51.00
	53	210.82	81.28	107.95	62.23	162.56	835.74
LL777SA-	2 1/2"	10.55	3.65	5.80	3.60	8.40	102.00
	63	267.97	92.71	147.32	91.44	213.36	1,671.48
LL87SA-	3"	10.55	4.40	5.80	3.60	8.40	132.00
	78	267.97	111.76	147.32	91.44	213.36	2,163.09
LL97SA-	3 1/2"	12.85	4.90	7.03	4.55	10.25	210.00
	91	326.39	124.46	178.56	115.57	260.35	3,441.28
LL107SA-	4"	12.85	5.40	7.03	4.55	10.25	243.00
	103	326.39	137.16	178.56	115.57	260.35	3,982.06



Up to and including 2 in.

Ocal-Blue conduit bodies

With covers – LR shape

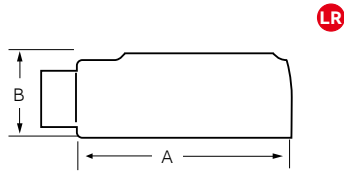

LR Form 7 Ferrous conduit bodies with covers

Product Code	Hub Size*	Dimensions (in. and mm)**					Vol. Cap. (cu.in./cu.cm.)
		A	B	C	D	E	
LR17- ₋	1/2"	4.60	1.40	1.45	0.95	3.20	4.00
	16	116.84	35.56	36.83	24.13	81.28	65.55
LR27- ₋	3/4"	5.25	1.60	1.65	1.15	3.80	6.60
	21	133.35	40.64	41.91	29.21	96.52	108.15
LR37- ₋	1"	6.00	1.90	2.60	1.35	4.55	10.60
	27	152.40	48.26	66.04	34.29	115.57	173.70
LR47- ₋	1 1/4"	6.45	2.30	3.05	1.80	5.00	18.80
	35	163.83	58.42	77.47	45.72	127.00	308.08
LR57- ₋	1 1/2"	7.90	2.60	3.80	2.05	5.45	26.40
	41	200.66	66.04	96.52	52.07	138.43	432.62
LR67- ₋	2"	8.30	3.20	4.25	2.45	6.40	51.00
	53	210.82	81.28	107.95	62.23	162.56	835.74
LR777- ₋	2 1/2"	10.55	3.65	5.80	3.60	8.40	102.00
	63	267.97	92.71	147.32	91.44	213.36	1,671.48
LR87- ₋	3"	10.55	4.40	5.80	3.60	8.40	132.00
	78	267.97	111.76	147.32	91.44	213.36	2,163.09
LR97- ₋	3 1/2"	12.85	4.90	7.03	4.55	10.25	210.00
	91	326.39	124.46	178.56	115.57	260.35	3,441.28
LR107- ₋	4"	12.85	5.40	7.03	4.55	10.25	243.00
	103	326.39	137.16	178.56	115.57	260.35	3,982.06

LR Form 8 Ferrous conduit bodies with covers

Product Code	Hub Size*	Dimensions (in. and mm)**					Vol. Cap. (cu.in./cu.cm.)
		A	B	C	D	E	
LR18-4X- ₋	1/2"	4.94	1.44	2.16	1.00	3.31	4.90
	16	125.41	36.51	54.77	25.40	84.14	80.30
LR28-4X- ₋	3/4"	5.56	1.69	2.31	1.19	3.94	8.00
	21	141.29	42.86	58.74	30.16	100.01	131.10
LR38-4X- ₋	1"	6.47	1.94	2.63	1.38	4.56	13.00
	27	164.31	49.21	66.68	34.93	115.89	213.03
LR448-4X- ₋	1 1/4"	7.53	2.38	3.16	1.75	5.31	23.50
	35	191.29	60.33	80.17	44.45	134.94	385.10
LR58-4X- ₋	1 1/2"	9.13	2.78	4.00	2.13	6.50	45.00
	41	231.78	70.64	101.60	53.98	165.10	737.42
LR68-4X- ₋	2"	11.00	3.56	5.00	3.00	8.56	88.00
	53	279.40	90.49	127.00	76.20	217.49	1,442.06
LR78- ₋	2 1/2"	13.94	4.44	6.69	4.25	10.88	110.00
	63	354.01	112.71	169.86	107.95	276.23	1,802.58
LR888- ₋	3"	13.94	4.81	6.69	4.25	10.88	110.00
	78	354.01	122.24	169.86	107.95	276.23	1,802.58

* Metric size designator (ANSI C80.1-1994).

** Dimensions shown are for uncoated conduit bodies.

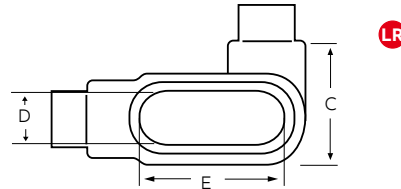

LR Mark 9 Aluminum conduit bodies with covers

Product Code	Hub Size*	Dimensions (in. and mm)**					Vol. Cap. (cu.in./cu.cm.)
		A	B	C	D	E	
LR19- ₋	1/2"	4.59	1.38	2.13	1.19	3.31	—
	16	116.68	34.93	53.98	30.16	84.14	—
LR29- ₋	3/4"	5.25	1.63	2.38	1.38	3.94	—
	21	133.35	41.28	60.33	34.93	100.01	—
LR39- ₋	1"	6.09	1.88	2.63	1.50	4.56	—
	27	154.78	47.63	66.68	38.10	115.89	—
LR49- ₋	1 1/4"	7.03	2.50	3.09	1.94	5.31	—
	35	178.59	63.50	78.58	49.21	134.94	—
LR59- ₋	1 1/2"	7.75	2.75	3.44	2.25	6.00	—
	41	196.85	69.85	87.31	57.15	152.40	—
LR69- ₋	2"	10.03	3.44	4.13	2.88	8.06	—
	53	254.79	87.31	104.78	73.03	204.79	—
LR789- ₋	2 1/2"	13.94	4.44	6.69	4.25	10.88	—
	63	354.01	112.71	169.86	107.95	276.23	—
LR889- ₋	3"	13.94	4.81	6.69	4.25	10.88	—
	78	354.08	122.24	169.93	107.95	276.35	—
LR989- ₋	3 1/2"	16.88	5.69	8.13	5.44	13.44	—
	91	428.63	144.46	206.38	138.11	341.31	—
LR1089- ₋	4"	16.88	5.94	8.13	5.44	13.44	—
	103	428.63	150.81	206.38	138.11	341.31	—

LR Form 7 Aluminum conduit bodies with covers

Product Code	Hub Size*	Dimensions (in. and mm)**					Vol. Cap. (cu.in./cu.cm.)
		A	B	C	D	E	
LR17SA- ₋	1/2"	4.60	1.40	1.45	0.95	3.20	4.00
	16	116.84	35.56	36.83	24.13	81.28	65.55
LR27SA- ₋	3/4"	5.25	1.60	1.65	1.15	3.80	6.60
	21	133.35	40.64	41.91	29.21	96.52	108.15
LR37SA- ₋	1"	6.00	1.90	2.60	1.35	4.55	10.60
	27	152.40	48.26	66.04	34.29	115.57	173.70
LR47SA- ₋	1 1/4"	6.45	2.30	3.05	1.80	5.00	18.80
	35	163.83	58.42	77.47	45.72	127.00	308.08
LR57SA- ₋	1 1/2"	7.90	2.60	3.80	2.05	5.45	26.40
	41	200.66	66.04	96.52	52.07	138.43	432.62
LR67SA- ₋	2"	8.30	3.20	4.25	2.45	6.40	51.00
	53	210.82	81.28	107.95	62.23	162.56	835.74
LR777SA- ₋	2 1/2"	10.55	3.65	5.80	3.60	8.40	102.00
	63	267.97	92.71	147.32	91.44	213.36	1,671.48
LR87SA- ₋	3"	10.55	4.40	5.80	3.60	8.40	132.00
	78	267.97	111.76	147.32	91.44	213.36	2,163.09
LR97SA- ₋	3 1/2"	12.85	4.90	7.03	4.55	10.25	210.00
	91	326.39	124.46	178.56	115.57	260.35	3,441.28
LR107SA- ₋	4"	12.85	5.40	7.03	4.55	10.25	243.00
	103	326.39	137.16	178.56	115.57	260.35	3,982.06



Up to and including 2 in.

Ocal-Blue conduit bodies

With covers – T shape

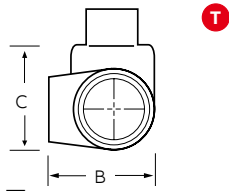

T Form 7 Ferrous conduit bodies with covers

Product Code	Hub Size*	Dimensions (in. and mm)**					Vol. Cap. (cu.in./cu.cm.)
		A	B	C	D	E	
T17-	1/2"	5.60	1.80	2.35	0.95	3.20	6.00
	16	142.24	45.72	59.69	24.13	81.28	98.32
T27-	3/4"	6.20	2.00	2.60	1.15	3.80	9.10
	21	157.48	50.80	66.04	29.21	96.52	149.12
T37-	1"	7.35	2.30	3.10	1.35	4.55	16.90
	27	186.69	58.42	78.74	34.29	115.57	276.94
T47-	1 1/4"	7.30	2.30	3.05	1.80	5.00	19.30
	35	185.42	58.42	77.47	45.72	127.00	316.27
T57-	1 1/2"	8.60	2.60	3.80	2.05	5.45	27.50
	41	218.44	66.04	96.52	52.07	138.43	450.64
T67-	2"	9.50	3.20	4.25	2.45	6.40	50.00
	53	241.30	81.28	107.95	62.23	162.56	819.35
T77-	2 1/2"	12.10	3.65	5.80	3.60	8.40	102.00
	63	307.34	92.71	147.32	91.44	213.36	1,671.48
T87-	3"	12.10	4.40	5.80	3.60	8.40	132.00
	78	307.34	111.76	147.32	91.44	213.36	2,163.09
T97-	3 1/2"	14.65	4.90	7.05	4.55	10.25	210.00
	91	372.11	124.46	179.07	115.57	260.35	3,441.28
T107-	4"	14.65	5.40	7.05	4.55	10.25	243.00
	103	372.11	137.16	179.07	115.57	260.35	3,982.06

T Form 8 Ferrous conduit bodies with covers

Product Code	Hub Size*	Dimensions (in. and mm)**					Vol. Cap. (cu.in./cu.cm.)
		A	B	C	D	E	
T18-4X-	1/2"	5.69	1.75	2.16	1.00	3.31	6.00
	16	144.46	44.45	54.77	25.40	84.14	98.32
T28-4X-	3/4"	6.28	2.00	2.31	1.19	3.94	9.00
	21	159.54	50.80	58.74	30.16	100.01	147.48
T38-4X-	1"	7.31	2.25	2.63	1.38	4.56	15.00
	27	185.74	57.15	66.68	34.93	115.89	245.81
T448-4X-	1 1/4"	8.50	2.63	3.16	1.75	5.31	24.00
	35	215.90	66.68	80.17	44.45	134.94	393.29
T58-4X-	1 1/2"	10.38	2.78	4.00	2.13	6.50	46.50
	41	263.53	70.64	101.60	53.98	165.10	762.00
T68-4X-	2"	12.25	3.56	5.00	3.00	8.56	88.00
	53	311.15	90.49	127.00	76.20	217.49	1,442.06
T78-	2 1/2"	15.63	4.44	6.69	4.25	10.88	110.00
	63	396.88	112.71	169.86	107.95	276.23	1,802.58
T88-	3"	15.63	4.81	6.69	4.25	10.88	110.00
	78	396.88	122.24	169.86	107.95	276.23	1,802.58

* Metric size designator (ANSI C80.1-1994).

** Dimensions shown are for uncoated conduit bodies.

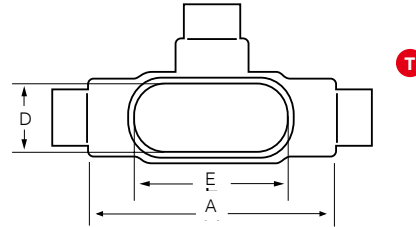

T Mark 9 Aluminum conduit bodies with covers

Product Code	Hub Size*	Dimensions (in. and mm)**					Vol. Cap. (cu.in./cu.cm.)
		A	B	C	D	E	
T19-	1/2"	50.00	1.38	2.13	1.19	3.31	—
	16	127.00	34.93	53.98	30.16	84.14	—
T29-	3/4"	5.69	1.63	2.38	1.38	3.94	—
	21	144.46	41.28	60.33	34.93	100.01	—
T39-	1"	6.59	1.88	2.63	1.50	4.56	—
	27	167.48	47.63	66.68	38.10	115.89	—
T49-	1 1/4"	7.50	2.50	3.09	1.94	5.31	—
	35	190.50	63.50	78.58	49.21	134.94	—
T59-	1 1/2"	8.25	2.75	3.44	2.25	6.00	—
	41	209.55	69.85	87.31	57.15	152.40	—
T69-	2"	10.50	3.44	4.13	2.88	8.06	—
	53	266.70	87.31	104.78	73.03	204.79	—
T789-	2 1/2"	15.63	4.44	6.69	4.25	10.88	—
	63	396.88	112.71	169.86	107.95	276.23	—
T889-	3"	15.63	4.81	6.69	4.25	10.88	—
	78	396.88	122.24	169.86	107.95	276.23	—
T989-	3 1/2"	18.75	5.69	8.13	5.44	13.44	—
	91	476.25	144.46	206.38	138.11	341.31	—
T1089-	4"	18.75	5.94	8.13	5.44	13.44	—
	103	476.25	150.81	206.38	138.11	341.31	—

T Form 7 Aluminum conduit bodies with covers

Product Code	Hub Size*	Dimensions (in. and mm)**					Vol. Cap. (cu.in./cu.cm.)
		A	B	C	D	E	
T17SA-	1/2"	5.60	1.80	2.35	0.95	3.20	6.00
	16	142.24	45.72	59.69	24.13	81.28	98.32
T27SA-	3/4"	6.20	2.00	2.60	1.15	3.80	9.10
	21	157.48	50.80	66.04	29.21	96.52	149.12
T37SA-	1"	7.35	2.30	3.10	1.35	4.55	16.90
	27	186.69	58.42	78.74	34.29	115.57	276.94
T47SA-	1 1/4"	7.30	2.30	3.05	1.80	5.00	19.30
	35	185.42	58.42	77.47	45.72	127.00	316.27
T57SA-	1 1/2"	8.60	2.60	3.80	2.05	5.45	27.50
	41	218.44	66.04	96.52	52.07	138.43	450.64
T67SA-	2"	9.50	3.20	4.25	2.45	6.40	50.00
	53	241.30	81.28	107.95	62.23	162.56	819.35
T77SA-	2 1/2"	12.10	3.65	5.80	3.60	8.40	102.00
	63	307.34	92.71	147.32	91.44	213.36	1,671.48
T87SA-	3"	12.10	4.40	5.80	3.60	8.40	132.00
	78	307.34	111.76	147.32	91.44	213.36	2,163.09
T97SA-	3 1/2"	14.65	4.90	7.05	4.55	10.25	210.00
	91	372.11	124.46	179.07	115.57	260.35	3,441.28
T107SA-	4"	14.65	5.40	7.05	4.55	10.25	243.00
	103	372.11	137.16	179.07	115.57	260.35	3,982.06



Up to and including 2 in.

Ocal-Blue conduit bodies

With covers – TB and LU shapes

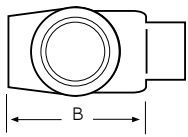

TB

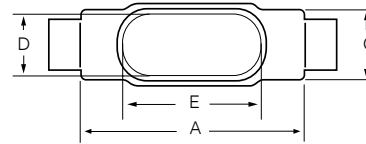

TB



Up to and including 2 in.

TB Form 7 Ferrous conduit bodies with covers

Product Code	Hub Size*	Dimensions (in. and mm)**					Vol. Cap. (cu.in./cu/cm.)
		A	B	C	D	E	
TB17-	1/2"	5.60	2.06	1.63	0.95	3.20	6.00
	16	142.24	52.32	41.40	24.13	81.28	98.32
TB27-	3/4"	6.20	2.31	1.81	1.15	3.80	9.10
	21	157.48	58.67	45.97	29.21	96.52	149.12
TB37-	1"	7.35	2.50	2.31	1.35	4.55	16.90
	27	186.69	63.50	58.67	34.29	115.57	276.94
TB47-	1 1/4"	7.30	3.19	2.25	1.80	5.00	19.30
	35	185.42	81.03	57.15	45.72	127.00	316.27
TB57-	1 1/2"	8.60	3.91	2.42	2.05	5.45	27.50
	41	218.44	99.31	61.47	52.07	138.43	450.64
TB67-	2"	9.50	4.50	3.06	2.45	6.40	52.80
	53	241.30	114.30	77.72	62.23	162.56	865.24

TB Mark 9 Aluminum conduit bodies with covers

Product Code	Hub Size*	Dimensions (in. and mm)**					Vol. Cap. (cu.in./cu/cm.)
		A	B	C	D	E	
TB19-	1/2"	5.00	2.13	1.38	1.19	3.31	—
	16	127.00	53.98	34.93	30.16	84.14	—
TB29-	3/4"	5.69	2.41	1.56	1.38	3.94	—
	21	144.46	61.12	39.69	34.93	100.01	—
TB39-	1"	6.59	2.84	1.75	1.50	4.56	—
	27	167.48	72.23	44.45	38.10	115.89	—
TB49-	1 1/4"	7.50	3.47	2.19	1.94	5.31	—
	35	190.50	88.11	55.56	49.21	134.94	—

TB Form 8 Ferrous conduit bodies with covers

Product Code	Hub Size*	Dimensions (in. and mm)**					Vol. Cap. (cu.in./cu/cm.)
		A	B	C	D	E	
TB18-4X-	1/2"	5.69	2.63	1.38	1.00	3.31	6.00
	16	144.46	66.68	34.93	25.40	84.14	98.32
TB28-4X-	3/4"	6.28	2.88	1.19	1.19	3.94	9.00
	21	159.54	73.03	30.16	30.16	100.01	147.48
TB38-4X-	1"	7.31	3.25	1.75	1.38	4.56	15.00
	27	185.74	82.55	44.45	34.93	115.89	245.81
TB448-4X-	1 1/4"	8.50	3.31	2.19	1.75	5.31	24.00
	35	215.90	84.14	55.56	44.45	134.94	393.29
TB58-4X-	1 1/2"	10.38	3.69	2.75	2.13	6.50	46.50
	41	263.53	93.66	69.85	53.98	165.10	762.00
TB68-4X-	2"	12.25	4.25	3.75	3.00	8.56	88.00
	53	311.15	107.95	95.25	76.2	217.49	1442.06

TB Form 7 Aluminum conduit bodies with covers

Product Code	Hub Size*	Dimensions (in. and mm)**					Vol. Cap. (cu.in./cu/cm.)
		A	B	C	D	E	
TB17SA-	1/2"	5.60	2.06	1.63	0.95	3.20	6.00
	16	142.24	52.32	41.40	24.13	81.28	98.32
TB27SA-	3/4"	6.20	2.31	1.81	1.15	3.80	9.10
	21	157.48	58.67	45.97	29.21	96.52	149.12
TB37SA-	1"	7.35	2.50	2.31	1.35	4.55	16.90
	27	186.69	63.50	58.67	34.29	115.57	276.94
TB47SA-	1 1/4"	7.30	3.19	2.25	1.80	5.00	19.30
	35	185.42	81.03	57.15	45.72	127.00	316.27
TB57SA-	1 1/2"	8.60	3.91	2.42	2.05	5.45	27.50
	41	218.44	99.31	61.47	52.07	138.43	450.64
TB67SA-	2"	9.50	4.50	3.06	2.45	6.40	52.80
	53	241.30	114.30	77.72	62.23	162.56	865.24

* Metric size designator (ANSI C80.1-1994).

** Dimensions shown are for uncoated conduit bodies.

LU Form 7 Ferrous conduit bodies with covers

Product Code	Hub Size*	Dimensions (in.)					cu.in.
		A	B	C	D	E	
LU17-	1/2"	5.54	1.45	2.72	0.95	3.20	4.80
LU27-	3/4"	6.22	1.70	3.07	1.15	3.80	7.60
LU37-	1"	7.34	1.97	3.52	1.35	4.55	13.40
LU47-	1 1/4"	8.40	2.47	4.21	1.80	5.00	23.00
LU57-	1 1/2"	8.95	2.72	4.44	2.05	5.45	28.30
LU67-	2"	10.61	3.43	5.43	2.45	6.40	56.00

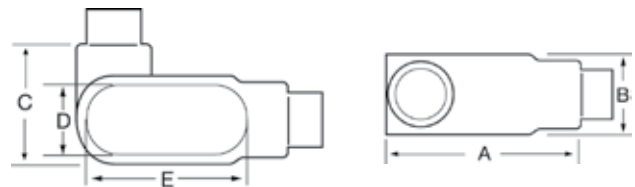

LU

LU Form 7

Ocal-Blue conduit bodies

With covers – X shape

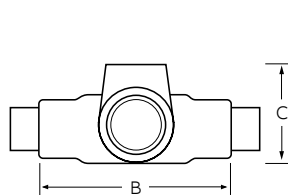
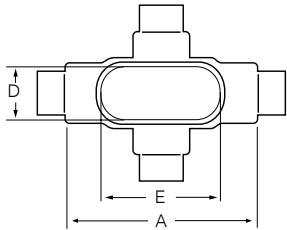

Up to and including 2 in.

X Form 7 Ferrous conduit bodies with covers

Product Code	Hub Size*	Dimensions (in. and mm)**					Vol. Cap. (cu.in./cu/cm.)
		A	B	C	D	E	
X17-	1/2"	5.60	1.80	3.05	0.95	3.20	6.00
	16	142.24	45.72	77.47	24.13	81.28	98.32
X27-	3/4"	6.20	2.00	3.30	1.15	3.80	9.10
	21	157.48	50.80	83.82	29.21	96.52	149.12
X37-	1"	7.35	2.30	3.80	1.35	4.55	16.90
	27	186.69	58.42	96.52	34.29	115.57	276.94
X47-	1 1/4"	7.30	2.30	3.85	1.80	5.00	19.30
	35	185.42	58.42	97.79	45.72	127.00	316.27
X57-	1 1/2"	8.60	2.60	5.05	2.05	5.45	27.50
	41	218.44	66.04	128.27	52.07	138.43	450.64
X67-	2"	9.50	3.20	5.45	2.45	6.40	52.80
	53	241.30	81.28	138.43	62.23	162.56	865.24

X Mark 9 Aluminum conduit bodies with covers

Product Code	Hub Size*	Dimensions (in. and mm)**					Vol. Cap. (cu.in./cu/cm.)
		A	B	C	D	E	
X19-	1/2"	5.69	2.91	1.75	1.00	3.31	—
	16	144.46	73.82	44.45	25.40	84.14	—
X29-	3/4"	6.28	3.06	2.00	1.19	3.94	—
	21	159.54	77.79	50.8	30.16	100.01	—
X39-	1"	7.31	3.50	2.25	1.38	4.56	—
	27	185.74	88.90	57.15	34.93	115.89	—

X Form 8 Ferrous conduit bodies with covers

Product Code	Hub Size*	Dimensions (in. and mm)**					Vol. Cap. (cu.in./cu/cm.)
		A	B	C	D	E	
X18-4X-	1/2"	5.69	1.75	2.91	1.00	3.31	6.00
	16	144.46	44.45	73.82	25.40	84.14	98.32
X28-4X-	3/4"	6.28	2.00	3.06	1.38	3.94	9.00
	21	159.54	50.80	77.79	34.93	100.01	147.48
X38-4X-	1"	7.31	2.25	3.50	1.38	4.56	15.00
	27	185.74	57.15	88.90	34.93	115.89	245.81
X448-4X-	1 1/4"	8.50	2.63	4.13	1.75	5.31	24.00
	35	215.90	66.68	104.78	44.45	134.94	393.29
X58-4X-	1 1/2"	10.38	2.47	5.25	2.13	6.50	46.50
	41	263.53	62.71	133.35	53.98	165.10	762.00
X68-4X-	2"	12.25	3.56	6.25	3.00	8.56	88.00
	53	311.15	90.49	158.75	76.20	217.49	1,442.06

X Form 7 Aluminum conduit bodies with covers

Product Code	Hub Size*	Dimensions (in. and mm)**					Vol. Cap. (cu.in./cu/cm.)
		A	B	C	D	E	
X17SA-	1/2"	5.60	1.80	3.05	0.95	3.20	6.00
	16	142.24	45.72	77.47	24.13	81.28	98.32
X27SA-	3/4"	6.20	2.00	3.30	1.15	3.80	9.10
	21	157.48	50.80	83.82	29.21	96.52	149.12
X37SA-	1"	7.35	2.30	3.80	1.35	4.55	16.90
	27	186.69	58.42	96.52	34.29	115.57	276.94
X47SA-	1 1/4"	7.30	2.30	3.85	1.80	5.00	19.30
	35	185.42	58.42	97.79	45.72	127.00	316.27
X57SA-	1 1/2"	8.60	2.60	5.05	2.05	5.45	27.50
	41	218.44	66.04	128.27	52.07	138.43	450.64
X67SA-	2"	9.50	3.20	5.45	2.45	6.40	52.80
	53	241.3	81.28	138.43	62.23	162.56	865.24

* Metric size designator (ANSI C80.1-1994).

** Dimensions shown are for uncoated conduit bodies.

Ocal-Blue double-coat pulling elbows

Make 90° bends while allowing straight pulls



LBD2200-G

LBD and LBH bodies are installed at 90° bends in rigid conduit to act as pull outlets for conductors that are stiff due to large size or type of insulation and to make 90° bends in conduit system while allowing straight wire pulls in either direction.

Product features

- Choose LBD series for ordinary locations and LBH series for hazardous locations
- Coated with a nominal .002" (2 mil) blue urethane on both interior and exterior
- Nominal .040" (40 mil) PVC coating bonded to exterior
- Pressure-sealing sleeves seal connections

Ocal-Blue double-coat pulling elbows

Ordinary LBD Series Cat. No.	Hazardous LBH Series** Cat. No.	Pipe Size (in.)	Metric Size Designator*
LBD1100- <u> </u>	LBH10- <u> </u>	1/2	16
LBD2200- <u> </u>	LBH20- <u> </u>	3/4	21
LBD3300- <u> </u>	LBH30- <u> </u>	1	27
LBD4400- <u> </u>	LBH40- <u> </u>	1 1/4	35
LBD5500- <u> </u>	LBH50- <u> </u>	1 1/2	41
LBD6600- <u> </u>	LBH60- <u> </u>	2	53
LBD7700- <u> </u>	LBH70- <u> </u>	2 1/2	63
LBD8800- <u> </u>	LBH80- <u> </u>	3	78
LBD9900- <u> </u>	LBH90- <u> </u>	3 1/2	91
LBD10900- <u> </u>	LBH100- <u> </u>	4	103
LBD012- <u> </u>	—	5	129
LBD014- <u> </u>	—	6	15

* Metric size designator (ANSI C80.1-1994).

** Ratings prior to PVC coating

Cat. No.	Colour
----------	--------

LBD1100-

 = space for color identifier

G = Gray

W = White

B = Blue

Custom colors also available.

Ocal-Blue double-coat mogul fittings

Make 90° bends while allowing straight pulls



BC3-G Mogul



BLB4-G Mogul



BUB3-G Mogul



BG48-G Replacement Cover

Install mogul fittings in conduit systems to act as pull outlets for conductors that are stiff due to large size or type of installation, to provide the longer openings needed when pulling large conductors, to prevent sharp bends and kinks in large conductors or to provide more splicing space.

Product features

- Nominal .002" (2 mil) blue urethane on both interior and exterior
- Nominal .040" (40 mil) PVC coating bonded to exterior
- Pressure-sealing sleeves protect connections

Ocal-Blue double-coat mogul fittings

Mogul fitting with cover and gasket				Replacement Cover Bg	Pipe Size (in.)	Metric Size Designator*
BC Cat. No.	BLB Cat. No.	BUB Cat. No.	BLB Cat. No.	Cat. No.		
BC3- <u> </u>	BLB3- <u> </u>	BUB3- <u> </u>	BLB3- <u> </u>	BG48- <u> </u>	1	27
BC4- <u> </u>	BLB4- <u> </u>	BUB4- <u> </u>	BLB4- <u> </u>	BG48- <u> </u>	1¼	35
BC5- <u> </u>	BLB5- <u> </u>	BUB5- <u> </u>	BLB5- <u> </u>	BG68- <u> </u>	1½	41
BC6- <u> </u>	BLB6- <u> </u>	BUB6- <u> </u>	BLB6- <u> </u>	BG68- <u> </u>	2	53
BC7- <u> </u>	BLB7- <u> </u>	BUB7- <u> </u>	BLB7- <u> </u>	BG88- <u> </u>	2½	63
BC8- <u> </u>	BLB8- <u> </u>	BUB8- <u> </u>	BLB8- <u> </u>	BG88- <u> </u>	3	78
BC9- <u> </u>	BLB9- <u> </u>	BUB9- <u> </u>	BLB9- <u> </u>	BG98- <u> </u>	3½	91
BC10- <u> </u>	BLB10- <u> </u>	BUB10- <u> </u>	BLB10- <u> </u>	BG98- <u> </u>	4	103

* Metric size designator (ANSI C80.1-1994).

Cat. No.	Colour
----------	--------

BC3-

 = space for color identifier

G = Gray

W = White

B = Blue

Custom colors also available.

Ocal-Blue double-coat service entrance elbows

Make 90° bends in limited space



LBY25-G



LBY Series elbows are installed in conduit systems to make 90° bends where space is limited, to act as pull outlets and to provide access to conductors for maintenance and future system changes.

Product features

- Nominal .002" (2 mil) blue urethane on both interior and exterior
- Nominal .040" (40 mil) PVC coating bonded to exterior
- Pressure-sealing sleeves protect connections

Ocal-Blue double-coat service entrance elbows

Cat. No.	Pipe Size (in.)	Metric Size Designator*
LBY15- <u> </u>	1/2	16
LBY25- <u> </u>	3/4	21
LBY35- <u> </u>	1	27
LBY45- <u> </u>	1 1/4	35
LBY55- <u> </u>	1 1/2	41

* Metric size designator (ANSI C80.1-1994).

Cat. No.	Colour
----------	--------

LBY15-

 = space for color identifier

G = Gray 

W = White 

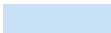
B = Blue 

Custom colors also available.

Ocal-Blue double-coat malleable elbows

End or change directions in conduit runs



EL Series elbows are installed at the end of conduit runs, in a box or a fitting hub to change direction in threaded rigid conduit run by 45° or 90° or when terminating at a box or fitting.

Product features

- Nominal .002" (2 mil) blue urethane on both interior and exterior
- Nominal .040" (40 mil) PVC coating bonded to exterior
- Pressure-sealing sleeves protect connections

Ocal-Blue double-coat malleable elbows

90° Male Cat. No.	90° Female Cat. No.	90° Male-Female Cat. No.	45° Female Cat. No.	Pipe Size (in.)	Metric Size Designator*
EL195- <u> </u>	EL19- <u> </u>	EL196- <u> </u>	EL1- <u> </u>	1/2	16
EL295- <u> </u>	EL29- <u> </u>	EL296- <u> </u>	EL2- <u> </u>	3/4	21
EL395- <u> </u>	EL39- <u> </u>	EL396- <u> </u>	EL3- <u> </u>	1	27
	EL49- <u> </u>	EL496- <u> </u>	EL4- <u> </u>	1 1/4	35
	EL59- <u> </u>		EL5- <u> </u>	1 1/2	41
	EL69- <u> </u>		EL6- <u> </u>	2	53
	EL79- <u> </u>		EL7- <u> </u>	2 1/2	63
			EL8- <u> </u>	3	78
LBY45- <u> </u>			EL9- <u> </u>	3 1/2	91
LBY55- <u> </u>			EL10- <u> </u>	4	103

* Metric size designator (ANSI C80.1-1994).

Cat. No.	Colour
----------	--------

EL195-

 = space for color identifier

G = Gray 

W = White 

B = Blue 

Custom colors also available.

Ocal-Blue double-coat

Unique sealing ring and groove design for optimum performance



HUB1-1/4-G
PVC-Coated Zinc Hub

STG6-G
PVC-Coated Zinc Grounded Hub

Product features

- Captive sealing ring won't buckle or slip during installation and provides a complete 360° seal – even when conduit isn't perpendicular to the enclosure
- Hexagonal/splined body and locknut enable fast and easy installation
- Insulated throat molded from 105° C-rated thermoplastic, UL94V0 flammability rated
- Sharper and deeper teeth provide a more penetrating bite for improved bonding to the enclosure
- Zinc or copper-free aluminum with a nominal .040" (40 mil) PVC coating bonded to exterior – in blue, white, gray or custom colors
- Pressure-sealing sleeves protect your connections

Knockout hubs

PVC Coated Zinc Hub Product Code	PVC Coated Aluminum Hub Product Code	PVC Coated Zinc Grounded Hub Product Code	Pipe Size (in.)	Metric Size Designator*	Dimensions (Uncoated Hub)									
					A (Overall Diameter)		B		C		D (Max. Panel Thickness)		E (Throat Diameter)	
					(in.)	(mm)	(in.)	(mm)	(in.)	(mm)	(in.)	(mm)	(in.)	(mm)
HUB1/2-	HUB1/2SA-	STG1-	1/2	16	1.44	36.58	1.56	39.62	0.88	22.35	0.19	4.83	0.59	14.99
HUB3/4-	HUB3/4SA-	STG2-	3/4	21	1.44	36.58	1.59	40.39	0.91	23.11	0.19	4.83	0.78	19.81
HUB1-	HUB1SA-	STG3-	1	27	2.00	50.80	1.81	45.97	1.06	26.92	0.25	6.35	1.00	25.40
HUB1-1/4-	HUB1-1/4SA-	STG4-	1 1/4	35	2.38	60.45	1.88	47.75	1.06	26.92	0.25	6.35	1.31	33.27
HUB1-1/2-	HUB1-1/2SA-	STG5-	1 1/2	41	2.75	69.85	1.88	47.75	1.06	26.92	0.25	6.35	1.53	38.86
HUB2-	HUB2SA-	STG6-	2	53	3.25	82.55	1.94	49.28	1.16	29.46	0.25	6.35	1.97	50.04
HUB2-1/2-	HUB2-1/2SA-	STG7-	2 1/2	63	3.75	95.25	2.56	65.02	1.56	39.62	0.25	6.35	2.41	61.21
HUB3-	HUB3SA-	STG8-	3	78	4.38	111.25	2.44	61.98	1.59	40.39	0.25	6.35	2.97	75.44
HUB3-1/2-	HUB3-1/2SA-	STG9-	3 1/2	91	5.00	127.00	2.72	69.09	1.63	41.40	0.25	6.35	3.41	86.61
HUB4-	HUB4SA-	STG10-	4	103	5.50	139.70	2.72	69.09	1.63	41.40	0.25	6.35	3.88	98.55
HUB5-	HUB5SA-	STG11-	5	129	6.88	174.75	3.03	76.96	1.94	49.28	0.25	6.35	4.94	125.48
HUB6-	HUB6SA-	STG12-	6	155	7.69	195.33	3.16	80.26	2.00	50.80	0.31	7.87	6.00	152.40

Cat. No. Colour

HUB1-

_ = space for color identifier

G = Gray

W = White

B = Blue

Custom colors also available.

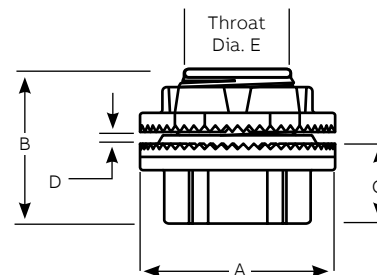

Grounding and bonding locknuts for hubs



Product features

- Available in zinc, copper-free aluminum
- UL File No. E-3060, CSA File No. 4484
- Use as replacement locknuts for the hubs featured opposite

Grounding and bonding locknuts for hubs



Zinc Product Code	Aluminum Product Code	Pipe Size (in.)	Metric Size Designator*	Diameter		Height		Ground Screw	Max. Cond. Size	
				(in.)	(mm)	(in.)	(mm)		AWG	(sq. mm)
L050GR-TB	L050GRA-TB	1/2	16	1.50	38.10	0.41	10.41	#10-32 x 1/4"	#10	6
L075GR-TB	L075GRA-TB	3/4	21	1.69	42.93	0.41	10.41	#10-32 x 1/4"	#10	6
L100GR-TB	L100GRA-TB	1	27	2.00	50.80	0.41	10.41	#10-32 x 1/4"	#10	6
L125GR-TB	L125GRA-TB	1 1/4	35	2.38	60.45	0.47	11.94	1/4-20 x 1/4"	#10	6
L150GR-TB	L150GRA-TB	1 1/2	41	2.75	69.85	0.47	11.94	1/4-20 x 5/16"	#8	10
L200GR-TB	L200GRA-TB	2	53	3.25	82.55	0.47	11.94	1/4-20 x 5/16"	#8	10
L250GR-TB	L250GRA-TB	2 1/2	63	3.75	95.25	0.69	17.53	1/4-20 x 5/16"	#6	16
L300GR-TB	L300GRA-TB	3	78	4.38	111.25	0.72	18.29	1/4-20 x 5/16"	#6	16
L350GR-TB	L350GRA-TB	3 1/2	91	5.00	127.00	0.72	18.29	1/4-20 x 5/16"	#6	16
L400GR-TB	L400GRA-TB	4	103	5.50	139.70	0.72	18.29	1/4-20 x 5/16"	#4	25
L500GR-TB	L500GRA-TB	5	129	6.63	168.40	0.72	18.29	3/8-16 x 3/8"	#2	35
L600GR-TB	L600GRA-TB	6	155	7.69	195.33	0.72	18.29	3/8-16 x 3/8"	#1	50

Ocal PVC-coated bulkhead fittings

In bulkhead and through-bulkhead styles



STTB2-G Bulkhead fitting

STTTB2-G Through-Bulkhead fitting

Product features

- Zinc body and locknut with thermoplastic insulating throat and nitrile sealing ring
- Nominal .040" (40 mil) PVC coating bonded to exterior – in blue, white, gray or custom colors
- Pressure-sealing sleeves protect your connections

Ocal PVC-coated bulkhead fittings

Bulkhead Fitting Cat. No.	Through Bulkhead Fitting Cat. No.	Pipe Size (in.)	Metric Size Designator*	Height		Diameter		Across Flats		A		B		
				Thread	(in.)	(mm)	(in.)	(mm)	(in.)	(mm)	(in.)	(mm)	(in.)	(mm)
STTB1- <u> </u>	STTTB1- <u> </u>	1/2	16	1/2-14	1.41	35.72	1.44	36.51	1.00	25.40	.75	19.05	.50	12.70
STTB2- <u> </u>	STTTB2- <u> </u>	3/4	21	3/4-14	1.47	37.31	1.69	42.86	1.25	31.75	.78	19.84	.53	13.49
STTB3- <u> </u>	STTTB3- <u> </u>	1	27	1-11 1/2	1.69	42.86	2.00	50.80	1.53	38.89	.91	23.02	.59	15.08
STTB4- <u> </u>	STTTB4- <u> </u>	1 1/4	35	1 1/4-11 1/2	1.78	45.24	2.38	60.33	1.84	46.83	.91	23.02	.66	16.67
STTB5- <u> </u>	STTTB5- <u> </u>	1 1/2	41	1 1/2-11 1/2	1.81	46.04	2.75	69.85	1.13	28.58	.91	23.02	.66	16.67
STTB6- <u> </u>	STTTB6- <u> </u>	2	53	2-11 1/2	1.84	46.83	3.25	82.55	2.63	66.68	.94	23.81	.66	16.67
STTB7- <u> </u>	—	2 1/2	63	2 1/2-8	2.28	57.94	3.75	95.25	3.13	79.38	1.22	30.96	.88	22.23
STTB8- <u> </u>	—	3	78	3-8	2.56	65.09	4.38	111.13	3.78	96.04	1.19	30.16	.91	23.02
STTB9- <u> </u>	—	3 1/2	91	3 1/2-8	2.56	65.09	5.00	127.00	4.28	108.74	1.38	34.93	.88	22.23
STTB10- <u> </u>	—	4	103	4-8	2.56	65.09	5.50	139.70	4.84	123.03	1.38	34.93	.88	22.23
STTB11- <u> </u>	—	5	129	5-8	2.72	69.06	6.63	168.28	5.91	150.02	1.47	37.31	.88	22.23
STTB12- <u> </u>	—	6	155	6-8	3.00	76.20	7.69	195.26	7.03	178.58	1.50	38.10	.97	24.61

* Metric size designator (ANSI C80.1-1994). Dimensions shown are for uncoated fittings.

Cat. No.	Colour
STTB1-	
<u> </u>	= space for color identifier
G = Gray	
W = White	
B = Blue	
Custom colors also available.	

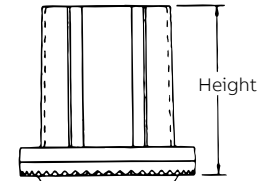
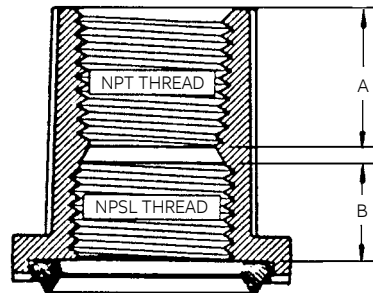

Bulkhead Fitting

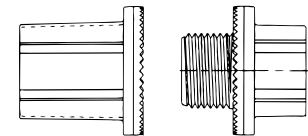

Through-Bulkhead Fitting

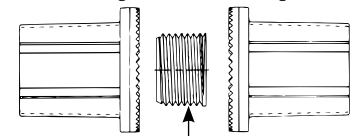

Nipple Nut Not included

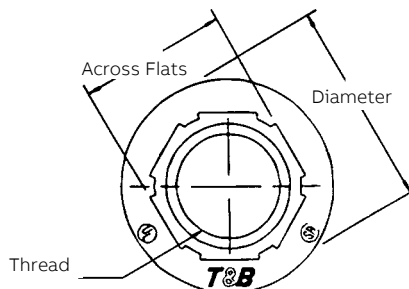

Ocal-Blue double-coat reducing couplings

Easily join two different sizes of conduit



REC21-G

Product features

- Integral bushings in both ends prevent damage to wires
- Funnel-shaped interior guides wires from large to small conduit, making them easier to pull
- Nominal .002" (2 mil) blue urethane coating on both interior and exterior
- Nominal .040" (40 mil) PVC coating bonded to exterior
- Pressure-sealing sleeves protect connections

Ocal-Blue double-coat reducing couplings

Cat. No.	Pipe Size	Metric Size	Pipe Size	Metric Size
	(in.)	Designator*	(in.)	Designator*
	A		B	
REC21-__	3/4	21	1/2	16
REC31-__	1	27	1/2	16
REC32-__	1	27	3/4	21
REC42-__	1 1/4	35	3/4	21
REC43-__	1 1/4	35	1	27
REC52-__	1 1/2	41	3/4	21
REC53-__	1 1/2	41	1	27
REC54-__	1 1/2	41	1 1/4	35
REC602-__	2	53	3/4	21

Cat. No.	Pipe Size	Metric Size	Pipe Size	Metric Size
	(in.)	Designator*	(in.)	Designator*
	A		B	
REC603-__	2	53	1	27
REC604-__	2	53	1 1/4	35
REC605-__	2	53	1 1/2	41
REC75-__	2 1/2	63	1 1/2	41
REC86-__	3	78	2	53
REC97-__	3 1/2	91	2 1/2	63
REC108-__	4	103	3	78
REC01210-__	5	129	4	103

* Metric size designator (ANSI C80.1-1994).

Cat. No. Colour

REC21-

__ = space for color identifier

G = Gray

W = White

B = Blue

Custom colors also available.

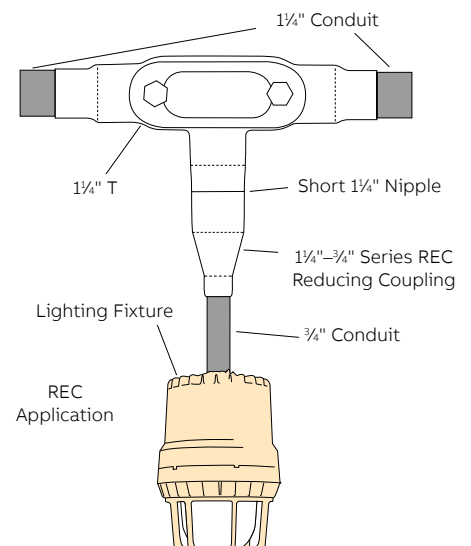

Ocal-Blue urethane-coated reducing bushings

Reduce a conduit hub to a smaller size



RE32-G

Ocal-Blue urethane-coated reducing bushings

Cat. No.	Pipe Size (in.)	Metric Size Designator*	Pipe Size (in.)	Metric Size Designator*
	A - Male		B - Female	
RE21-G	3/4	21	1/2	16
RE31-G	1	27	1/2	16
RE32-G	1	27	3/4	21
RE41-G	1 1/4	35	1/2	16
RE42-G	1 1/4	35	3/4	21
RE43-G	1 1/4	35	1	21
RE51-G	1 1/2	41	1/2	16
RE52-G	1 1/2	41	3/4	21

Cat. No.	Pipe Size (in.)	Metric Size Designator*	Pipe Size (in.)	Metric Size Designator*
	A - Male		B - Female	
RE74-G	2 1/2	63	1 1/4	35
RE75-G	2 1/2	63	1 1/2	41
RE76-G	2 1/2	63	2	53
RE83-G	3	78	1	27
RE84-G	3	78	1 1/4	35
RE85-G	3	78	1 1/2	41
RE86-G	3	78	2	53
RE87-G	3	78	2 1/2	63

Cat. No.	Pipe Size (in.)	Metric Size Designator*	Pipe Size (in.)	Metric Size Designator*
	A - Male		B - Female	
RE53-G	1 1/2	41	1	27
RE54-G	1 1/2	41	1 1/4	35
RE61-G	2	53	1/2	16
RE62-G	2	53	3/4	21
RE63-G	2	53	1	27
RE64-G	2	53	1 1/4	16
RE65-G	2	53	1 1/2	41
RE73-G	2 1/2	63	1	27

Cat. No.	Pipe Size (in.)	Metric Size Designator*	Pipe Size (in.)	Metric Size Designator*
	A - Male		B - Female	
RE96-G	3 1/2	91	2	53
RE97-G	3 1/2	91	2 1/2	63
RE98-G	3 1/2	91	3	78
RE106-G	4	103	2	53
RE107-G	4	103	2 1/2	63
RE108-G	4	103	3	78

* Metric size designator (ANSI C80.1-1994).

Ocal PVC-coated XJG rigid conduit expansion coupling

No disassembly required

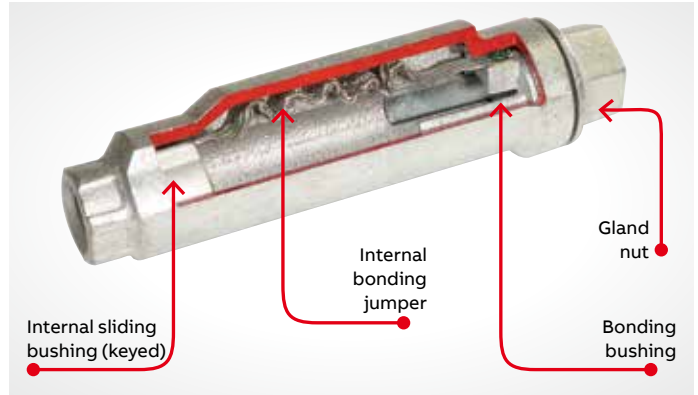

- 01 Slide the fitting onto the conduit until it stops at the internal sliding bushing. Tighten and you're ready. No parts to reassemble!
- 02 With a wrench, tighten the gland nut to create a raintight seal around the conduit.
- 03 Thread the next length of conduit into the other end of the fitting and tighten. You're done!

When you install a rigid expansion coupling in a long conduit run, you normally need three hands, two strong backs and lots of patience. Now you can relax.

With the no-hassle XJG rigid conduit expansion coupling, installation's just a few turns and you're done.

The XJG rigid conduit expansion coupling features innovations that provide convenience to the installer, saving time and money on the job. No disassembly is needed during installation, requiring fewer tools and less opportunity for lost pieces. It also features a true internal bonding jumper, eliminating the need for external jumpers, so there are fewer parts to buy and install.

If you need a fitting that can give and take without a lot of hassle, reach for the XJG rigid conduit expansion coupling. It's the latest breakthrough in the industry's leading line of conduit fittings.

Innovative design makes installations easier.

- No disassembly necessary to install
- Fast, simple and requires fewer steps
- True internal bonding jumper – no external grounding strap required
- Tamper-proof internal jumper protected from the environment
- Exceeds code requirements for long conduit runs to permit linear movement
- Double coated with a nominal 0.002 in. (2 mils) blue urethane, on both the interior and exterior, before PVC coating is applied
- A minimum of 0.040 in. (40 mils) PVC coating is bonded to the exterior
- Pressure sealing sleeve to seal the connection



01



02



03

Ocal PVC-coated XJG rigid conduit expansion coupling



XJG24-G
4" Movement

Standard materials/finish

- Body/Finish: Ductile iron with nominal 40-mil PVC exterior coating
- Internal bonding jumper: Only copper braid

Ocal PVC-coated XJG rigid conduit expansion coupling

Cat. No.	Pipe Size (in.)	Metric Size Designator*	Movement		A Diameter		B Length		C Height	
			(in.)	(mm)	(in.)	(mm)	(in.)	(mm)	(in.)	(mm)
XJG24-	3/4	21	4.00	101.60	2.43	61.72	10.00	254.00	2.75	69.85
XJG28-	3/4	21	8.00	203.20	2.43	61.72	14.00	355.60	2.75	69.85
XJG34-	1	27	4.00	101.60	2.67	61.72	10.00	254.00	2.99	75.95
XJG38-	1	27	8.00	203.20	2.67	61.72	14.00	355.60	2.99	75.95
XJG44-	1 1/4	35	4.00	101.60	3.36	85.34	10.56	268.22	3.68	93.47
XJG48-	1 1/4	35	8.00	203.20	3.36	85.34	14.56	369.82	3.68	93.47
XJG54-	1 1/2	41	4.00	101.60	3.36	85.34	10.56	268.22	3.68	93.47
XJG58-	1 1/2	41	8.00	203.20	3.36	85.34	14.56	369.82	3.68	93.47
XJG64-	2	53	4.00	101.60	3.86	98.04	11.25	285.75	4.18	106.17
XJG68-	2	53	8.00	203.20	3.86	98.04	15.25	387.35	4.18	106.17
XJG74-	2 1/2	63	4.00	101.60	4.96	125.98	12.12	307.85	5.25	133.35
XJG78-	2 1/2	63	8.00	203.20	4.96	125.98	16.12	409.45	5.25	133.35
XJG84-	3	78	4.00	101.60	4.96	125.98	12.12	307.85	5.25	133.35
XJG88-	3	78	8.00	203.20	4.96	125.98	16.12	409.45	5.25	133.35
XJG94-	3 1/2	91	4.00	101.60	6.37	161.80	12.87	326.90	6.75	171.45
XJG98-	3 1/2	91	8.00	203.20	6.37	161.80	16.87	428.50	6.75	171.45
XJG104-	4	103	4.00	101.60	6.37	161.80	12.87	326.90	6.75	171.45
XJG108-	4	103	8.00	203.20	6.37	161.80	16.87	428.50	6.75	171.45
XJG1208-	5	129	8.00	203.20	7.99	202.94	18.87	479.30	8.56	217.42

* Metric size designator (ANSI C80.1-1994).
Dimensions shown are for uncoated coupling.

Cat. No. Colour

XJG24-

_ = space for color identifier

G = Gray

W = White

B = Blue

Custom colors also available.

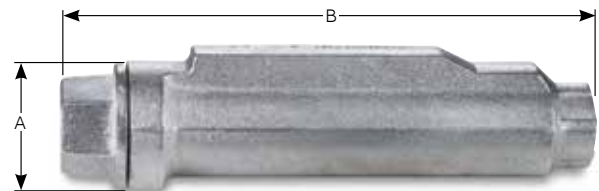

Coupling shown uncoated

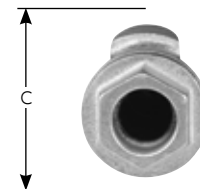

Ocal PVC-coated liquidtight conduit connectors

The ultimate liquidtight solution for corrosive environments



ST3/490-G 90° Angled



ST3/4-G Straight



ST3/445-G 45° Angled

Product features

- Nominal .040" (40 mil) PVC coating bonded to exterior – available in gray, white, blue or custom colors
- Pressure-sealing sleeves protect the connection
- Ocal uses only genuine ABB liquidtight fittings to ensure quality installations
- Ground ring meets UL 467 for grounding and bonding
- Ground ring made with naval brass

Non-grounding connectors

PVC-Coated Steel Straight Cat. No.	PVC-Coated Aluminum Straight Cat. No.	PVC-Coated Steel 45° Cat. No.	PVC-Coated Steel 90° Cat. No.	PVC-Coated Aluminum 90° Cat. No.	Pipe Size (in.)	Metric Size Designator*
ST3/8-	ST3/8SA-	ST3/845-	ST3/890-	ST3/890SA-	3/8	12
ST1/2-	ST1/2SA-	ST1/245-	ST1/290-	ST1/290SA-	1/2	16
ST3/4-	ST3/4SA-	ST3/445-	ST3/490-	ST3/490SA-	3/4	21
ST1-	ST1SA-	ST145-	ST190-	ST190SA-	1	27
ST1-1/4-	ST1-1/4SA-	ST1-1/445-	ST1-1/490-	ST1-1/490SA-	1 1/4	35
ST1-1/2-	ST1-1/2SA-	ST1-1/245-	ST1-1/290-	ST1-1/290SA-	1 1/2	41
ST2-	ST2SA-	ST245-	ST290-	ST290SA-	2	53
ST2-1/2-	ST2-1/2SA-	ST2-1/245-	ST2-1/290-			
ST3-	ST3SA-	ST345-	ST390-			
ST4-	ST4SA-	ST445-	ST490-			

* Metric size designator (ANSI C80.1-1994).



T3/490GR-G 90° Angled



T3/4GR-G-Straight





ST3/445GR-G-45° Angled

Connectors with grounding ring

PVC-Coated Steel Straight Cat. No.	PVC-Coated Aluminum Straight Cat. No.	PVC-Coated Steel 45° Cat. No.	Pipe Size (in.)	Metric Size Designator*
ST1/2GR-	ST1/245GR-	ST1/290GR-	1/2	16
ST3/4GR-	ST3/445GR-	ST3/490GR-	3/4	21
ST1GR-	ST145GR-	ST190GR-	1	27
ST1-1/4GR-	ST1-1/445GR-	ST1-1/490GR-	1 1/4	35
ST1-1/2GR-	ST1-1/245GR-	ST1-1/290GR-	1 1/2	41
ST2GR-	ST245GR-	ST290GR-	2	53
ST2-1/2GR-	ST2-1/245GR-	ST21/290GR-	2 1/2	63
ST3GR-	ST345GR-	ST390GR-	3	78
ST4GR-	ST445GR-	ST490GR-	4	103

* Metric size designator (ANSI C80.1-1994).

Product Code	Material	Colour
ST3/4	—	—
	Blank =	
	Steel/Iron	G = Gray 
	Aluminum	SA = W = White 
		B = Blue 
GR in Cat. No. designates ground ring.	Custom colors also available.	

Ocal-Blue double-coat FS and FD series device boxes

Variety of styles offers versatility



Install these boxes in conduit systems to accommodate wiring devices, act as pull boxes for conductors, provide openings to make splices and taps and provide access to conductors for maintenance and future system changes.

Product features

- Cast class 30 gray iron alloy boxes
- Coated with a nominal .002" (2 mil) blue urethane on both the interior and exterior before urethane coating is applied
- Nominal .040" (40 mil) PVC coating bonded to exterior
- PVC coating available in your choice of blue, white or gray with custom colors available on request
- Pressure-sealing sleeves protect connections with conduit

Ocal-Blue double-coat FS and FD series device boxes

Dead End Cat. No.	Feed-Thru Cat. No.	Hub Right Cat. No.	Hub Left Cat. No.	Style	Pipe Size (in.)	Metric Size Designator*
Single-Gang						
FS1- <u> </u>	FSC1- <u> </u>	FSR1- <u> </u>	FSL1- <u> </u>	Shallow	1/2	16
FS2- <u> </u>	FSC2- <u> </u>	FSR2- <u> </u>	FSL2- <u> </u>	Shallow	3/4	21
FS3- <u> </u>	FSC3- <u> </u>	—	—	Shallow	1	27
FD1- <u> </u>	FDC1- <u> </u>	FDR1- <u> </u>	FDL1- <u> </u>	Deep	1/2	16
FD2- <u> </u>	FDC2- <u> </u>	FDR2- <u> </u>	FDL2- <u> </u>	Deep	3/4	21
FD3- <u> </u>	FDC3- <u> </u>	—	—	Deep	1	27
—	FSCC2- <u> </u>	—	—	Shallow	3/4	21
—	FDCC2- <u> </u>	—	—	Deep	3/4	21
FSS2- <u> </u>	—	—	—	Shallow	3/4	21
FDD2- <u> </u>	—	—	—	Deep	3/4	21
Double-Gang						
FS22- <u> </u>	—	—	—	Shallow	3/4	21
FD22- <u> </u>	—	—	—	Deep	3/4	21
FSS222- <u> </u>	—	—	—	Shallow	3/4	21
FDS222- <u> </u>	—	—	—	Deep	3/4	21
—	FSC222- <u> </u>	—	—	Shallow	3/4	21
—	FDC222- <u> </u>	—	—	Deep	3/4	21

*Metric size designator (ANSI C80.1-1994).

Cat. No. Colour

FS1-

 = space for color identifier

G = Gray

W = White

B = Blue

Custom colors also available.

Ocal-Blue double-coat FS and FD series covers

Designed for use with Ocal FS and FD series boxes



Ocal-Blue double-coat FS and FD series covers

Cat. No.	Description	Material
Single-gang		
DS23- <u> </u>	Duplex Receptacle Cover	Steel
DS21G- <u> </u>	Round Flush Receptacle Cover	Iron
DS32G- <u> </u>	Toggle Switch Cover	Iron
DS100G- <u> </u>	Blank Cover	Aluminum
Single-gang — NEMA 3R Raintight when used with appropriate Ocal boxes		
CWPDR-FS-G- <u> </u>	Duplex Receptacle Cover – Box Mount – Horizontal	Aluminum
CFSDR-G- <u> </u>	Duplex Receptacle Cover – Box Mount – Vertical	Aluminum
CFSHG-G- <u> </u>	GFCI Receptacle Cover – Box Mount – Horizontal	Aluminum
CFSRG-G- <u> </u>	GFCI Receptacle Cover – Box Mount – Vertical	Aluminum
DS185- <u> </u>	Front Lever Switch Cover – Box Mount – NEMA 4	Aluminum
Double-gang		
S1002G- <u> </u>	Blank Cover	Iron
S322G- <u> </u>	2-Toggle Switch Cover	Iron
S232- <u> </u>	2-Duplex Receptacle Cover	Stamped Steel
S232GFI- <u> </u>	2-GFCI Receptacle Cover	Steel
Double-gang — NEMA 3R Raintight when used with appropriate Ocal boxes		
DS1282- <u> </u>	2-Plunger-Style Switch Cover	Aluminum

PVC-coated covers in other styles and materials are available upon request. Contact Technical Services for more information.

Cat. No. Colour

DS23-

 = space for color identifier

G = Gray

W = White

B = Blue

Custom colors also available.

Ocal-Blue double-coat conduit unions



Explosion-proof, dust-ignition-proof three-piece couplings



Product features

- Install in threaded thick-wall conduit systems in hazardous areas
- Use UNY male unions to connect conduit to a conduit fitting, junction box or device enclosure
- Use UNF female unions to connect conduit to conduit or to provide means for future modifications to the conduit system
- Nominal .002" (2 mil) blue urethane on interior and exterior
- Nominal .040" (40 mil) PVC coating bonded to exterior
- Pressure-sealing sleeves protect your connection
- Explosion-proof, dust-ignition-proof and suitable for use in the following environments:[†]
 - Class I, Divisions 1 & 2, Groups A, B, C, D
 - Class II, Division 1, Groups E, F, G
 - Class III, Divisions 1 & 2



UNY male unions

	Cat. No.	Pipe Size (in.)	Metric Size Designator*	Overall Length		Overall Dimensions	
				(in.)	(mm)	(in.)	(mm)
	UNY105- <u> </u>	1/2	16	2.39	60.71	1.50	38.10
	UNY205- <u> </u>	3/4	21	2.44	61.98	1.81	45.97
	UNY305- <u> </u>	1	27	2.75	69.85	2.00	50.80
	UNY405- <u> </u>	1 1/4	35	3.06	77.72	2.75	69.85
	UNY505- <u> </u>	1 1/2	41	3.63	92.20	3.06	77.72
	UNY605- <u> </u>	2	53	3.50	88.90	3.81	96.77
	UNY705- <u> </u>	2 1/2	63	4.81	122.17	4.31	109.47
	UNY805- <u> </u>	3	78	5.34	135.64	5.06	128.52
	UNY905- <u> </u>	3 1/2	91	5.50	139.70	5.69	144.53
	UNY1005- <u> </u>	4	103	5.63	143.00	6.19	157.23
	UNY012- <u> </u>	5	129	5.25	133.35	8.19	208.03
	UNY014- <u> </u>	6	155	5.38	136.65	9.31	236.47

UNY Male 1/2"-4"
(shown uncoated)

UNY Male 5"-6"
(shown uncoated)

UNY female unions

	Cat. No.	Pipe Size (in.)	Metric Size Designator*	Overall Length		Overall Dimensions	
				(in.)	(mm)	(in.)	(mm)
	UNF105- <u> </u>	1/2	16	1.88	47.75	1.50	38.10
	UNF205- <u> </u>	3/4	21	2.13	54.10	1.81	45.97
	UNF305- <u> </u>	1	27	2.16	54.86	2.00	50.80
	UNF405- <u> </u>	1 1/4	35	2.25	57.15	2.75	69.85
	UNF505- <u> </u>	1 1/2	41	2.75	69.85	3.06	77.72
	UNF605- <u> </u>	2	53	2.50	63.50	3.81	96.77
	UNF705- <u> </u>	2 1/2	63	3.50	88.90	4.31	109.47
	UNF805- <u> </u>	3	78	4.00	101.60	5.06	128.52
	UNF905- <u> </u>	3 1/2	91	4.16	105.66	5.69	144.53
	UNF1005- <u> </u>	4	103	4.25	107.95	6.19	157.23
	UNF012- <u> </u>	5	129	3.81	96.77	8.19	208.03
	UNF014- <u> </u>	6	155	3.81	96.77	9.31	236.47

UNF Female 5"-6"
(shown uncoated)

* Metric size designator (ANSI C80.1-1994). † Ratings prior to PVC coating.

Cat. No. Colour

UNF105-

 = space for color identifier

G = Gray 

W = White 

B = Blue 

Custom colors also available.

Ocal-Blue double-coat GUA series conduit boxes

Provides access to wiring, directional changes in conduit and more



GUA series conduit boxes are installed in hazardous areas to protect conductors, act as pull and splice boxes, provide access to conductors for maintenance and future system changes, act as mounting outlets for fixtures (with proper covers) or change conduit direction.

Product features

- Grade 60-45-10 ductile iron bodies and cast aluminum covers (iron covers also available)
- Nominal .002" (2 mil) blue urethane coating on both interior and exterior and nominal .040" (40 mil) PVC coating bonded to exterior
- All hubs have minimum five full threads, integral bushing and pressure-sealing sleeves
- All units furnished with internal grounding screw and ship complete with aluminum cover with O-ring gasket (covers also sold separately for replacement purposes)
- Explosion-proof, dust-ignition-proof and suitable for use in the following environments:[†]
 - Class I, Divisions 1 & 2, Groups A, B, C, D
 - Class II, Division 1, Groups E, F, G
 - Class III, Divisions 1 & 2

Listings/Certifications[†]

- UL514A wet locations (when used with gasketed covers)
- UL886
- CSA C22.2 No. 30



Ocal-Blue double-coat GUA series conduit boxes

Cat. No.					Aluminum Cover Only	Iron Cover Only	Pipe Size (in.)	Metric Size Designator*	Cover Opening (in.) (mm)	
GUA	GUAC	GUAT	GUAX	GUAB						
GUA14-	GUAC14-	GUAT14-	GUAX14-	GUAB14-	GUA04-	GUA04WOD-	1/2	16	2.00	50.80
GUA24-	GUAC24-	GUAT24-	GUAX24-	GUAB24-	GUA04-	GUA04WOD-	3/4	21	2.00	50.80
GUA16-	GUAC16-	GUAT16-	GUAX16-	GUAB16-	GUA06-	GUA06WOD-	1/2	16	3.00	76.20
GUA26-	GUAC26-	GUAT26-	GUAX26-	GUAB26-	GUA06-	GUA06WOD-	3/4	21	3.00	76.20
GUA36-	GUAC36-	GUAT36-	GUAX36-	GUAB36-	GUA06-	GUA06WOD-	1	27	3.00	76.20
—	—	GUAT37-	GUAX37-	—	GUA07-	GUA07WOD-	1	27	3.63	92.20
GUA47-	GUAC47-	GUAT47-	GUAX47-	GUAB47-	GUA07-	GUA07WOD-	1 1/4	35	3.63	92.20
—	GUAC49-	GUAT49-	GUAX49-	—	GUA09-	GUA09WOD-	1 1/4	35	5.00	127.00
GUA59-	GUAC59-	GUAT59-	GUAX59-	GUAB59-	GUA09-	GUA09WOD-	1 1/2	41	5.00	127.00
—	GUAC69-	GUAT69-	GUAX69-	GUAB69-	GUA09-	GUA09WOD-	2	53	5.00	127.00

* Metric size designator (ANSI C80.1-1994). † Ratings prior to PVC coating.

Cat. No.	Material	Colour
GUA14-	SA-	
	SA = Aluminum*	_ = space for color identifier
		G = Gray
		W = White
		B = Blue
		Custom colors also available.

** Aluminum only for these parts:
 GUAC16SA-, GUAC24SA-, GUAC26SA-, GUAC36SA-, GUAC47SA-, GUAC59SA-,
 GUAC69SA-, GUAT16SA-, GUAT24SA-, GUAT26SA-, GUAT36SA-, GUAT47SA-,
 GUAT49SA-, GUAT59SA-, GUAT69SA-, GUAX26SA-, GUAX36SA-, GUAX47SA-,
 GUAX69SA-, GUAB14SA-, GUAB26SA-, GUAB36SA-, GUAB47SA-, GUAB59SA-,
 GUAB69SA

Ocal-Blue double-coat GUA series conduit boxes (continued)

Provides access to wiring, directional changes in conduit and more



GUAD



GUAL



GUAM



GUAN



GUAW

Ocal-Blue double-coat GUA series conduit boxes



Cat. No.	Aluminum Cover Only	Iron Cover Only	Pipe Size (in.)	Metric Size Designator*	Cover Opening (in.)	Cover Opening (mm)				
GUAD14- GUAD24- GUAD16- GUAD26- GUAD36- — GUAD49- — —	GUAL14- GUAL24- GUAL16- GUAL26- GUAL36- — GUAL49- — —	GUAM14- GUAM24- GUAM16- GUAM26- GUAM36- — GUAM47- — —	GUAN14- GUAN24- GUAN16- GUAN26- GUAN36- — GUAN47- — GUAN59- GUAN69-	GUAW14- GUAW24- GUAW16- GUAW26- — — — — —	GUA04- GUA04- GUA06- GUA06- GUA06- GUA07- GUA09- GUA09- GUA09-	GUA04WOD- GUA04WOD- GUA06WOD- GUA06WOD- GUA06WOD- GUA07WOD- GUA09WOD- GUA09WOD- GUA09WOD-	1/2 3/4 1/2 3/4 1 1 1/4 1 1/4 1 1/2 2	16 21 16 21 27 35 35 41 53	2.00 2.00 3.00 3.00 3.00 3.63 5.00 5.00 5.00	50.80 50.80 76.20 76.20 76.20 92.20 127.00 127.00 127.00

* Ratings prior to PVC coating.

Cat. No.	Material	Colour
GUAD14-	SA-	
	SA = Aluminum*	_ = space for color identifier
		G = Gray
		W = White
		B = Blue
		Custom colors also available.

** Aluminum only for these parts:
GUAD26SA-, GUAD36SA-, GUAL16SA-, GUAL24SA-, GUAL26SA-, GUAL36SA-,
GUAL47SA-, GUAL59SA-, GUAL69SA-, GUAW26SA-

Ocal-Blue double-coat external aluminum hubs with covers and installed green ground screw

Junction boxes for branch conduit in hazardous locations



GAC



GAE



GALB



GAT



GAL

Product features

- Accessible wiring chamber provides a convenient location to maintain or change a system, pull conductors and make splices
- Unique mounting pads and rugged protective housing ideal for installation of OEM devices or instruments
- Die-cast copper-free aluminum alloy A360 construction with precision cast and machined surfaces
- Precision NPT threaded hubs for trouble-free field installation
- Nominal 0.002" (2 mil) blue urethane coating on both interior and exterior and nominal 0.040" (40 mil) PVC coating bonded to exterior
- Explosion-proof, dust-ignition-proof and suitable for use in the following environments:^{††}
 - Class I, Divisions 1 & 2, Groups C, D
 - Class II, Division 1, Groups E, F, G
 - Class III, Divisions 1 & 2
 - NEMA 3, 4, 7 CD, 9 EFG (NEMA 4 rated when ordered with O-ring installed)



Ocal-Blue double-coat external aluminum hubs with covers and installed green ground screw

Cat. No.									
Through-Feed W/Surf. Cover	Dead End W/Surf. Cover	L-Style W/Surf. Cover	LB-Style W/Surf. Cover	T-Style W/Surf. Cover	Surface Cover Only	Pipe Size (in.)	Metric Size Designator*	Cover Opening (in.) (mm)	
GAC	GAE	GAL	GALB	GAT	GAS				
—	GAE-1- _†	—	—	—	—	1/2	16	3.69	93.73
—	—	—	GALB-2- _†	—	—	3/4	21	3.69	93.73
GAC-3- _†	GAE-3- _†	—	—	—	—	1	27	3.69	93.73
GAC-4- _†	—	GAL-4- _†	—	—	—	1 1/4	35	3.91	99.31
GAC-5- _†	—	GAL-5- _†	GALB-5- _†	GAT-5- _†	—	1 1/2	41	5.19	131.83
GAC-6- _†	—	GAL-6- _†	—	—	—	2	53	5.19	131.83

* Metric size designator (ANSI C80.1-1994).

• Made-to-order item. Consult factory for lead time and minimum quantities.

† Ratings prior to PVC coating.

†† Ratings prior to PVC coating.

Cat. No. Colour

GAC-1-

= space for color identifier

G = Gray

W = White

B = Blue

Custom colors also available.

Ocal-Blue double-coat external aluminum hubs with covers and installed green ground screw (continued)

Junction boxes for branch conduit in hazardous locations



GAX



GAFX



GAJU
(shown uncoated)



GAS



GAD

GAJ
(shown uncoated)

Ocal-Blue double-coat external aluminum hubs with covers and installed green ground screw



Cat. No.

X-Style W/Surf. Cover	X-Style W/ Flange & Surf. Cover	U-Style Surface W/ Canopy Cover	Surface Cover Only	Dome Cover Only (Class I, GR. D)	Canopy Cover Only	Pipe Size (in.)	Metric Size Designator*	Cover Opening (in.)	Cover Opening (mm)
GAX	GAFX	GAJU	GAS	GAD	GAJ				
—	—	GAJU-1-_*	—	—	—	1/2	16	3.69	93.73
—	—	—	GALB-2-_*†	—	—	3/4	21	3.69	93.73
—	GAFX-3-_*†	—	—	—	—	1	27	3.69	93.73
GAX-4-_*†	—	—	—	—	—	1 1/4	35	3.91	99.31
GAX-5-_*†	—	GAJU-5-_*	GALB-5-_*†	—	—	1 1/2	41	5.19	131.83
GAX-6-_*†	—	—	—	—	—	2	53	5.19	131.83

* Metric size designator (ANSI C80.1-1994).

• Made-to-order item. Consult factory for lead time and minimum quantities.

† Ratings prior to PVC coating.

†† Ratings prior to PVC coating.

Cat. No. **Colour**

GAX-1

_ = space for color identifier

G = Gray

W = White

B = Blue

Custom colors also available.

Ocal-Blue double-coat sealing fittings

Restrict the passage of gases, vapors and flames at atmospheric pressure and normal ambient temperatures



EYD



EYS

Product features

- Prevents pre-compression or “pressure piling” in conduit systems
- Grey iron alloy body construction coated with nominal 0.002 in. (2 mils) blue urethane on both interior and exterior
- Nominal .040" (40 mil) PVC coating bonded to exterior – available in gray, white, blue or custom colors
- Explosion-proof, dust-ignition-proof and suitable for use in the following environments:†
 - Class I, Divisions 1 & 2, Groups C, D
 - Class II, Division 1, Groups E, F, G
 - Class III, Divisions 1 & 2

EYD Series drain sealing fittings

Female Product Code	Male & Female Product Code	Pipe Size (in.)	Metric Size Designator*	Dimensions				Turning Radius	
				A		B		(in.)	(mm)
EYD1-	EYD16-	1/2	16	3.81	96.77	1.50	38.10	1.75	44.45
EYD2-	EYD26-	3/4	21	4.08	103.63	1.75	44.45	1.98	50.29
EYD3-	EYD36-	1	27	4.85	123.19	2.19	55.63	2.19	55.63
EYD4-	EYD46-	1 1/4	35	5.00	127.00	2.25	57.15	1.80	45.72
EYD5-	EYD56-	1 1/2	41	5.44	138.18	2.44	61.98	2.00	50.80
EYD6-	EYD66-	2	53	6.25	158.75	3.00	76.20	2.32	58.93
EYD7-	EYD76-	2 1/2	63	7.50	190.50	3.50	88.90	2.69	68.33
EYD8-	EYD86-	3	78	8.50	215.90	4.25	107.95	3.15	80.01
EYD9-	EYD96-	3 1/2	91	9.19	233.43	4.75	120.65	3.38	85.85
EYD10-	EYD106-	4	103	9.75	247.65	5.25	133.35	3.64	92.46

EYS Series sealing fittings

Female Product Code	Male & Female Product Code	Pipe Size (in.)	Metric Size Designator*	Dimensions						Turning Radius	
				A		B		C		(in.)	(mm)
Vertical Only											
EYS1-	EYS116-	1/2	16	3.31	84.07	1.25	31.75	1.50	38.10	1.66	42.16
EYS21-	EYS26-	3/4	21	3.65	92.71	1.50	38.10	1.75	44.45	1.96	49.78
EYS3-	EYS36-	1	27	4.25	107.95	1.75	44.45	2.19	55.63	2.40	60.96
Vertical or Horizontal											
EYS11-	EYS116-	1/2	16	3.63	92.20	1.25	31.75	—	—	1.09	27.69
EYS21-	EYS216-	3/4	21	3.66	92.96	1.50	38.10	—	—	1.25	31.75
EYS31-	EYS316-	1	27	4.25	107.95	1.75	44.45	—	—	1.59	40.39
EYS4-	EYS46-	1 1/4	35	5.00	127.00	2.25	57.15	—	—	1.81	45.97
EYS5-	EYS56-	1 1/2	41	5.44	138.18	2.44	61.98	—	—	2.00	50.80
EYS6-	EYS66-	2	53	6.25	158.75	3.00	76.20	—	—	2.31	58.67
EYS7-	EYS76-	2 1/2	63	7.50	190.50	3.50	88.90	—	—	2.56	65.02
EYS8-	EYS86-	3	78	8.50	215.90	4.25	107.95	—	—	3.09	78.49
EYS9-	EYS96-	3 1/2	91	9.19	233.43	4.75	120.65	—	—	3.38	85.85
EYS10-	EYS106-	4	103	9.75	247.65	5.25	133.35	—	—	3.53	89.66

IMPORTANT: Must be used with Chico^{MC} sealing compound and fiber see page F50.

† Ratings prior to PVC coating. EYSX and EYDX are expanded-fill styles. When ordering, add X to part number. For example: EYSX31-G, EYDX31-B. Metric size designator (ANSI C80.1-1994).

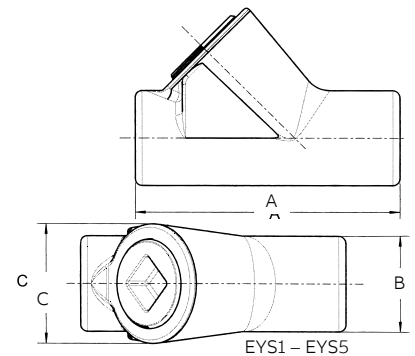
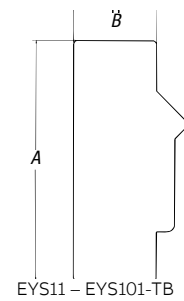
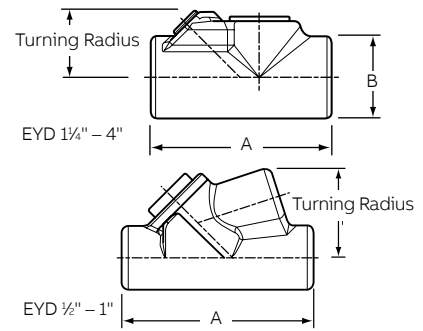

Ocal-Blue double-coat sealing fittings (continued)

Restrict the passage of gases, vapors and flames at atmospheric pressure and normal ambient temperatures



EYS



EYS



EYS
With inspection cover off



EYS Series sealing fittings

Female Product Code	Male & Female Cat. No.	Pipe Size (in.)	Metric Size Designator*
EYS1- <u> </u>	EYS16- <u> </u>	1/2	16
EYS2- <u> </u>	EYS26- <u> </u>	3/4	21
EYS3- <u> </u>	EYS36- <u> </u>	1	27
EYS4- <u> </u>	EYS46- <u> </u>	1 1/4	35
EYS5- <u> </u>	EYS56- <u> </u>	1 1/2	41
EYS6- <u> </u>	EYS66- <u> </u>	2	53
EYS7- <u> </u>	EYS76- <u> </u>	2 1/2	63
EYS8- <u> </u>	EYS86- <u> </u>	3	78

* Metric size designator (ANSI C80.1-1994).

† Ratings prior to PVC coating.

EZD Series sealing fittings

Cat. No.	Pipe Size (in.)	Metric Size Designator*
EZD111- <u> </u>	1/2	16
EZD211- <u> </u>	3/4	21
EZD311- <u> </u>	1	27
EZD411- <u> </u>	1 1/4	35
EZD511- <u> </u>	1 1/2	41
EZD611- <u> </u>	2	53

* Metric size designator (ANSI C80.1-1994).

EYS1- Colour

EYS1-

 = space for color identifier

G = Gray 

W = White 

B = Blue 

Custom colors also available.

Chico® sealing compound and fiber

Ensures proper functioning of EYS sealing fittings.



SEAL-A3



FIBER-X6

Ocal-Blue double-coat EYS sealing fittings require fiber filler and sealing compound to function properly. Use Chico® X fiber filler to form a dam around the sealing fitting's integral bushing, as well as at the end of the conduit and around conductors entering the hub. Chico® A sealing compound expands slightly while hardening and bonds to the inner walls of the sealing fitting.

Product features

- Sealing compound mixes with water, pours easily and hardens in 60–70 minutes
- Fiber filler mineral wool holds sealing compound in place while it hardens

Chico® sealing compound and fiber

Cat. No.	Description
SEAL-A3	Chico® A sealing compound, 1 lb net wt./23 cu.in. vol.
FIBER-X6	Chico® X fiber filler, 8 oz.
SEALKIT-A4	Chico® A sealing compound, 1 lb net wt./23 cu.in. vol., with 1 oz. Chico® X fiber filler

Chico® is a registered trademark of Cooper Crouse-Hinds.

Ocal PVC-coated steel strut

Rugged steel channels protected by corrosion-resistant PVC

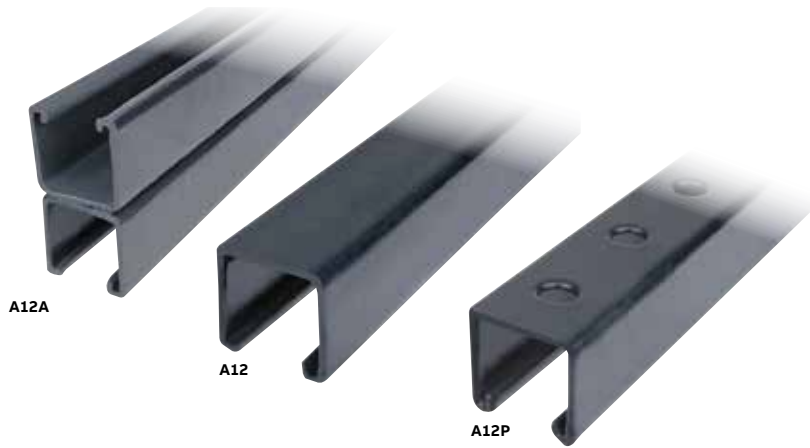

Product features

- Electro-galvanized zinc plated
- Nominal .007 - .015" (7 - 15 mil) PVC coating
- PVC coating available in your choice of blue, white or gray standard colors
- Custom colors also available on request
- Sold in 10-ft. (3.048m) lengths with standard length tolerance of $\pm 1/8"$ (3.18mm)
- Choose between standard $1\frac{5}{8}"$ (41.28mm) and shallow $1\frac{3}{16}"$ (20.64mm) depths
- Available in both solid and punched styles
- Not recommended for vertical applications

Ocal PVC-coated steel strut

Product Code	Style	Steel Thickness		Width x Height	
		Gauge	(mm)	(in.)	(mm)
A12- <u> </u>	Standard	12	2.65	1.63 x 1.63	41.28 x 41.28
A12A- <u> </u>	Back to Back	12	2.65	1.63 x 3.25	41.28 x 82.55
A12P- <u> </u>	Standard Punched	12	2.65	1.63 x 1.63	41.28 x 41.28
C14- <u> </u>	Shallow	14	1.89	1.63 x .81	41.28 x 20.64
C14P- <u> </u>	Shallow Punched	14	1.89	1.63 x .81	41.28 x 20.64

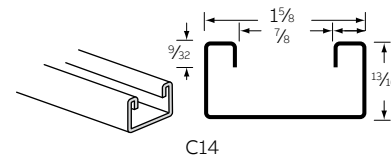
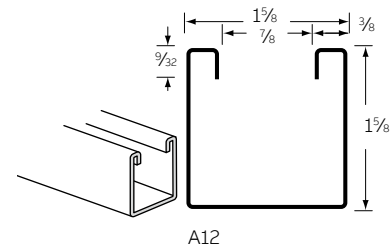

Cat. No. Colour

A12-

 = space for color identifier

G = Gray

W = White

B = Blue

Custom colors also available.

All-thread rod

Continuously threaded rod for use with conduit hangers and strut to suspend overhead conduit runs



Product features

- All-thread steel rod coated with Nominal .007 - .015" (7 - 15 mil) PVC in blue, white or gray with custom colors available on request
- Available in 1/4", 3/8" or 1/2" standard diameters and in 3-, 6- or 10-ft. standard lengths
- Also available uncoated in Type 304 or Type 316 stainless steel
- Stainless steel all-thread rod comes in 3/8" or 1/2" diameters in 6-ft. standard lengths with other diameters and lengths available on request

Ocal PVC-coated steel all-thread rod

Cat. No.	Trade Size		Length	
	(in.)	(mm)	(ft.)	(mm)
THR1/4X10- <u> </u>	1/4	6.35	10.00	3.05
THR3/8X3- <u> </u>	3/8	9.53	3.00	0.91
THR3/8X6- <u> </u>	3/8	9.53	6.00	1.83
THR3/8X10- <u> </u>	3/8	9.53	10.00	3.05
THR1/2X3- <u> </u>	1/2	12.70	3.00	0.91
THR1/2X6- <u> </u>	1/2	12.70	6.00	1.83
THR1/2X10- <u> </u>	1/2	12.70	10.00	3.05

Stainless steel all-thread rod

Type 304 Stainless Cat. No.	Type 316 Stainless Cat. No.	Trade Size		Length	
		(in.)	(mm)	(ft.)	(mm)
H104-3/8X6SS	H104 3/8X6SS316	3/8	9.53	6.00	1.83
H104 3/8X12SS	H104-3/8X12SS6	3/8	9.53	12.00	3.66
H104-1/2X6SSC	H104-1/2X6SS6	1/2	12.70	6.00	1.83
H104 1/2X12SS	H104 1/2X12SS316	1/2	12.70	12.00	3.66

Cat. No.	Diameter x Length	Colour
THR	3/8 x 3-	<u> </u>

 = space for color identifier

G = Gray 

W = White 

B = Blue 

Custom colors also available.

Ocal PVC-coated hanger rod beam clamps

Corrosion-protected clamps for hanging threaded rod

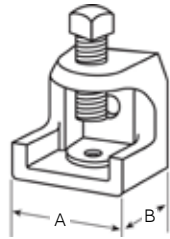

500-G
Hanger Rod Beam Clamp

Product features

- Malleable iron construction
- Nominal .007 - .015" (7 - 15 mil) PVC coating in blue, white, gray or custom colors
- 500, 502 and 503 also available uncoated in Type 316 stainless steel; add -SS316 to catalog number to order (for example: 502-SS316)



Ocal PVC-coated hanger rod beam clamps

Cat. No.	Base "A"		Base "B"		Jaw Opening		Tapped Hole		Load Rating [†]	
	(in.)	(mm)	(in.)	(mm)	(in.)	(mm)	(in.)	(mm)	(lbs)	(kg)
500- <u> </u>	1	25.40	1 ¹ / ₄	31.75	1 ⁵ / ₁₆	23.81	1 ¹ / ₄ -20	6.35 - 20	450	204.12
501- <u> </u>	1 ¹ / ₂	38.10	1 ⁵ / ₈	41.28	7/ ₈	22.23	1 ⁵ / ₁₆ -18	7.94 - 18	800	362.87
502- <u> </u>	2	50.80	2	50.80	1	25.40	3/ ₈ -16	9.53 - 16	1300	589.67
503- <u> </u>	2 ⁵ / ₈	66.68	2 ¹ / ₂	63.50	1	25.40	1 ¹ / ₂ -13	12.70 - 13	1300	589.67
508- <u> </u>	2 ¹ / ₂	63.50	2 ³ / ₈	60.33	2 ¹ / ₈	53.98	1 ¹ / ₂ -13	12.70 - 13	1700	771.11

* Metric size designator (ANSI C80.1-1994).

[†] Load ratings based on bottom hole of beam clamp with safety factor of three.

CSA File No. LR-52208

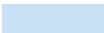
Cat. No.	Colour
500- <u> </u>	<u> </u>
<u> </u>	<u> </u> = space for color identifier
	G = Gray 
	W = White 
	B = Blue 
	Custom colors also available.

Ocal PVC-coated mini conduit hangers

Includes stainless steel bolt and nut for fast, easy installation



MINE3/4-G
Mini Conduit Hanger

Product features

- Nominal .007 - .015" (7 - 15 mil) PVC coating in blue, white, gray or custom colors
- Rated for loads of up to 500 lbs (226.80kg) with a safety factor of three

Ocal PVC-coated mini conduit hangers

Cat. No.	Pipe Size (in.)	Metric Size Designator*
MINE1/2-__	1/2	16
MINE3/4-__	3/4	21
MINE1-__	1	27
MINE1-1/4-__	1 1/4	35
MINE1-1/2-__	1 1/2	41

* Metric size designator (ANSI C80.1-1994).

Cat. No.	Pipe Size (in.)	Metric Size Designator*
MINE2-__	2	53
MINE2-1/2-__	2 1/2	63
MINE3-__	3	78
MINE3-1/2-__	3 1/2	91
MINE4-__	4	103

Cat. No.	Colour
----------	--------

MINE1-

__ = space for color identifier

G = Gray

W = White

B = Blue

Custom colors also available.

Pipe straps for strut

Designed for easy attachment of conduit to strut



PVC-coated pipe strap

Just twist-insert these pipe straps anywhere you need them along the slot side of a channel. For additional flexibility, you can position the straps as closely as your pipe couplings permit.



Product features

- Combination slot and hex head bolt for flexibility of attachment
- Captivated square nut on shoulder enable easy one-handed tightening
- Use with either 1⁵/₈" or 1¹/₂" strut for greater versatility
- Shipped pre-assembled for easier counting, sorting and handling
- Available with nominal .007 - .015" (7 - 15 mil) PVC coating in your choice of blue, white or gray standard colors (custom colors also available on request)

Ocal PVC-coated strut pipe straps

Ocal PVC-Coated Strut Pipe Straps	Pipe Size (in.)	Metric Size Designator*
SS1/2- <u> </u>	1/2	16
SS3/4- <u> </u>	3/4	21
SS1- <u> </u>	1	27
SS1-1/4- <u> </u>	1 1/4	35
SS1-1/2- <u> </u>	1 1/2	41
SS2- <u> </u>	2	53
SS2-1/2- <u> </u>	2 1/2	63
SS3- <u> </u>	3	78
SS3-1/2- <u> </u>	3 1/2	91
SS4- <u> </u>	4	103
SS5- <u> </u>	5	129

* Metric size designator (ANSI C80.1-1994).

Cat. No.	Colour
SS-1	
	<u> </u> = space for color identifier
	G = Gray 
	W = White 
	B = Blue 
	Custom colors also available.

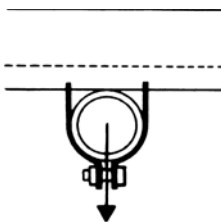
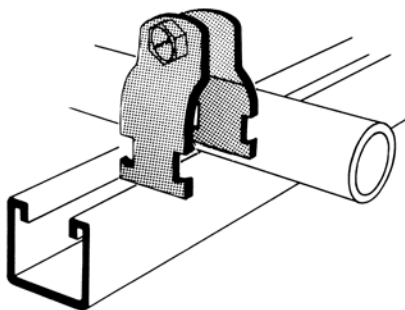

Ocal installation products

The right tools for the job

ABB Ocal PVC-coated conduit is designed to prevent corrosion from striking weak points in conduit systems. But any PVC-coated conduit system is only as good as the installation job. The wrong tools can result in incorrectly installed pipes and fittings or damage to PVC coating, creating those weak points where corrosion starts.

After careful research and evaluation, ABB now offers you the very best installation tools available for PVC-coated conduit. These tools are ready for use on PVC-coated conduit right out of the box. What that means to you, the installer, is lower costs – in equipment, in installation time and in time you'd normally have to spend adapting standard tools for use on PVC-coated conduit.

Hassle-Free Installation

Count on ABB to provide a hassle-free way for installers to get the right tools for the job in their hands – just another benefit of using Ocal products.

For more information on Ocal Installation Guidelines, see pages F72-F78.



GREENLEE® Model 555 electric bender for PVC-coated conduit

Bends 1/2" through 2" PVC-coated conduit



When you use this electric bending machine on 1/2" through 2" conduit, the shoes as well as the roller assembly should be of the type designed specifically for use with PVC-coated conduit.

If you use conventional shoes, the shoes and each of the rollers in the roller assembly must be machined 60 thousandths. Some manufacturers use slide bars instead of a roller assembly, and these, too, must be machined 60 thousandths.

Be sure to compensate for "spring back," since PVC coating often requires the setting to be off as much as 5°.

GREENLEE® Model 555 electric bender for PVC-coated conduit

Cat. No.	Description
GBENDER	GREENLEE® Model 555 Bender
Shoes and roller kit for 40-mil PVC-coated conduit	
12586	1/2" – 2" Shoes and Roller Supports

Hand bender for PVC-coated conduit

Make saddles, offsets and conventional bends



Hand bender for PVC-coated conduit

Cat. No.	Conduit Size (in.)
35220	1/2
35225	3/4
2424A8	1

Ridgid stationary power threading machine

1224 Series

Stationary power threading machines such as the Ridgid model number 1224 have the capacity to thread rigid conduit from 1/2" to 4".



- The standard jaw inserts for these units are intended to secure uncoated rigid conduit. The teeth of the standard jaw inserts will penetrate the PVC coating, but not bite into the steel. As a result, the standard jaw inserts will grind the PVC coating off the conduit. To prevent this, shell style clamps or jaw inserts for coated conduit may be used.

- **Shell clamps – Range: 1/2" to 3 1/2"**

To properly clamp the conduit, the shell style clamps described earlier can be used on conduit sizes from 1/2" to 3 1/2". However, for 4" conduit, there is not enough room in the chuck to accommodate both the 4 in. conduit and shell clamps.

- **Jaw inserts for coated conduit – Range: 1/2" to 4"**

The jaw inserts for coated conduit have a wider surface area to effectively grip the PVC coating. Ridgid Catalogue No. 26247 is the jaw insert for coated conduit used in the Ridgid 1224 threading machine.

There is no need to pencil cut or score the PVC because these threading machines use a roller cutter and remove 1/4 in. of the PVC coating. Cuttings simply fall onto the screen on the lower portion of the machine.

01 Special jaw insert for PVC coated conduit
Ridgid model number 97365 and 26247

02 Standard jaw insert

03 In hot weather, use scored shell clamps to prevent slipping



01



02



03

Ridgid 700 portable threader and die heads

For PVC coated conduit



Handheld

The Ridgid #12R is typically used for smaller size conduit. The ratchet knob indicates forward and reverse. Die heads snap in from both sides and lock in place. (#12R includes ratchet and handle only)

Handheld powered

The Ridgid 700 Power Drive is a heavy duty handheld tool typically used for conduit up to 2 inches diameter. The 700 Power Drive is designed for Ridgid 12R dies, available in both 115V and 230V models. Optional case is available for this tool.

Ridgid 700 portable threader

Cat. No.	Description
Ridgid 700 portable threader and die heads for PVC coated conduit	
51857	high speed ½ in. 12R die head
51862	high speed ¾ in. 12R die head
51867	high speed 1 in. 12R die head
51872	high speed 1 ¼ in. 12R die head
51877	high speed 1 ½ in. 12R die head
51882	high speed 2 in. 12R die head

Ridgid Tools 460-6

Tri-stand chain vise



Product features

- Sturdy, stable frame collapses for easy mobility and storage
- Ceiling brace for overhead support enables you to secure frame even during difficult work
- Features recesses for bending tubes 3/8", 1/2" and 3/4" O.D.

Ridgid Tools 460-6

Cat. No.	Description	Pipe Capacity	
		in.	Metric Size Designator*
Ridgid Tools 460-6	Tri-Stand with 6" Chain Vise (use with Ocal Half-Shell Clamps)	1/2 - 6	16 - 155

* Metric size designator (ANSI C80.1-1994).

Ocal jaws for PVC-coated conduit

Designed to hold PVC-coated conduit safely and securely in a yoke-style vise

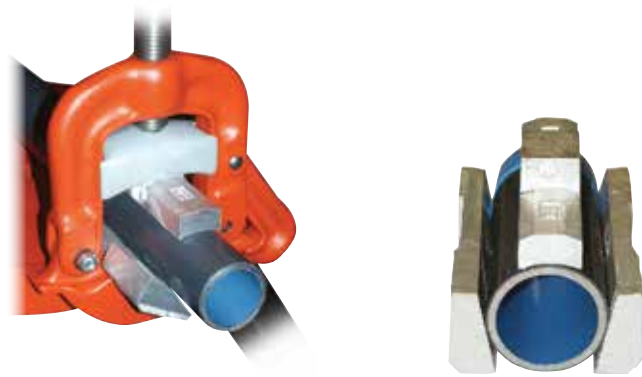

Product features

- Replaces the standard jaw inserts in a yoke vise
- Provides greater clamping force and prevents pipe from spinning during threading
- Machined aluminum construction
- Three-piece set

Ocal jaws for PVC-coated conduit

Cat. No.	Description	(lbs)	Weight (kg)
JAWS23	Used with RIDGID No. 23 Yoke Vise	2.80	1.27

Steel pipe cutters

Specially designed for cutting PVC-coated conduit



Product features

- Easy pressure control transmits optimum force onto tube
- Hardened, high-alloy steel cutter wheel provides long service life and burr-free external cutting

Steel pipe cutters

Cat. No.	Description	Pipe O.D.
P70045C	Steel Pipe Cutter – Up to 2	1/8–2
P70060C	Steel Pipe Cutter – Up to 4	1/8–4

Ratchet pipe reamer

Rapid and clean deburring



Product features

- Smooth-running ratchet
- Tempered-steel cutting bit
- For steel tubes 1/4" to 2" O.D.

Ratchet pipe reamer

Cat. No.	Description	Pipe O.D. (in.)
70289	Ratchet Pipe Reamer	1/4–2

Ocal J-wrenches

Removable aluminum jaws for PVC-coated conduit

Use with our pliers, or purchase just the jaws and adapt your own!



Ratchet pipe reamer

Cat. No.	Description	Pipe Capacity (in.)
J442	12" J-Wrench with Jaws	1/2 - 1 1/4
J460	16" J-Wrench with Jaws	1 1/2 - 2 1/2
J42	12" Jaw Set only	1/2 - 1 1/4
J60	16" Jaw Set only	1 1/2 - 2 1/2

Strap wrenches

Specially coated strap won't absorb oil



Strap wrenches

Cat. No.	Handle Length		Strap Length		Strap Width		Pipe Capacity		Pipe Capacity (O.D.)		Weight	
	(in.)	(mm)	(in.)	(mm)	(in.)	(mm)	(in.)	(mm)	(in.)	(mm)	(lbs)	(kg)
31355	11.75	298.45	17.00	431.80	1.75	44.45	2.00	50.80	3.50	88.90	1.75	.79
31370	18.00	457.20	29.25	742.95	1.75	44.45	5.00	127.00	5.50	139.70	2.75	1.25

KOPR-SHIELD® joint compound

Protects, lubricates and enhances the conductivity of all electrical connections



Product features

- Meets NEC® requirements for protection against corrosion: “Where corrosion protection is necessary and the conduit is threaded in the field, all threads shall be coated with an approved electrically conductive, corrosion-resistant compound.”
- Extremely adhesive compound flows smoothly into uneven contours and voids, ensuring easy application and complete, positive protection and lubrication
- Won't settle out, thin, thicken, harden or dry out under the most severe environmental conditions
- Excellent temperature characteristics — can be brushed on at -50° F to 250° F (-45° C to 121° C) and remains intact for short periods even at 1,800° F (982° C)
- Ensures low resistance and seals out air and moisture
- Unique, homogenized blend of pure, polished colloidal copper, rust and corrosion inhibitors

NEC and National Electrical Code are registered trademarks of the National Fire Protection Association, Inc.

KOPR-SHIELD® joint compound



Cat. No.	Container	Size
201-31879	Brush Cap Can	1½ oz. (.04 liter)
201-31879-1	4 oz. Container with Brush	4 oz. (.12 liter)
CP8-TB	8 oz. Container with Brush	8 oz. (.24 liter)
CP16	16 oz. Container with Brush	16 oz. (.47 liter)
CP128	1 Gallon Can	1 gallon (3.79 liter)

Note: Not recommended for food & beverage processing applications.

Ocal touch-up compounds

Fast-drying, air-cure patch for Ocal conduit and fittings



Ocal touch-up compounds

Cat. No.	Container	Size	Color
Exterior PVC Patch			
SPRAY-G	Spray Can	12½ oz. (0.37 liter)	Dark Gray
SPRAY-W	Spray Can	12½ oz. (0.37 liter)	White
SPRAY-B	Spray Can	12½ oz. (0.37 liter)	Light Blue
PATCHP-G	Brush Cap Can	1 pint (0.47 liter)	Dark Gray
PATCHP-W	Brush Cap Can	1 pint (0.47 liter)	White
PATCHP-B	Brush Cap Can	1 pint (0.47 liter)	Light Blue
PATCHG-G	Bottle	1 gallon (3.79 liter)	Dark Gray
PATCHG-W	Bottle	1 gallon (3.79 liter)	White
PATCHG-B	Bottle	1 gallon (3.79 liter)	Light Blue
Interior Urethane Patch			
URETHANEPATCH	Brush Cap Can	1 pint (0.47 liter)	Blue

Note: Not recommended for food & beverage processing applications.

Ocal heat-cure patch

A better patching solution for hot weather applications



Even in the best of installations, the PVC jacket on PVC-coated conduit or fittings can be cut, nicked or abraded. To maintain corrosion protection, Ocal has added a new, thicker PVC patch to its offering of touch-up compounds.

Ideal for use in hot weather, Ocal heat-cure patch offers a thicker consistency at high ambient temperatures than standard air-cure patches, ensuring better coverage and a more effective patch.

Ocal Heat-cure patch makes patching fast and easy.

1. Make sure the area to be patched is clean and dry.
2. Squeeze the amount of patch material needed onto the area to be repaired.
3. If necessary, spread and level the patch material with a putty knife.
4. Apply heat with a heat gun or torch, such as the ABB Portable heat-shrink torch.
5. Being careful not to overheat (500° F/260°C max.), apply heat for two minutes total, or at least one minute after surface of patch has turned glossy. (The patch material is a glossy liquid that turns flat with initial heat application and then turns glossy again as heating continues.)

NEC and National Electrical Code are registered trademarks of the National Fire Protection Association, Inc.

Ocal heat-cure patch

Cat. No.	Color	Size
PATCHT-G	Dark Gray	6 oz. (.18 liter)
PATCHT-W	White	6 oz. (.18 liter)
PATCHT-B	Light Blue	6 oz. (.18 liter)

Portable heat-shrink torch

Separate controls enable precise adjustment of flame and temperature



Product features

- 2,500° F (1,371° C) output capacity satisfies virtually any heating, brazing or soldering requirement
- Dual fuel- and air-flow controls enable separate adjustment of temperature and flame precision
- Brass and steel construction provides durability
- Operates on standard butane lighter fluid (not included)
- Operating Time (per full fuel tank): Up to 220 minutes
- Fuel Tank Capacity: 2.03 fl. oz. / 60.03ml

Ocal touch-up compounds

Cat. No.	Description	Dimensions (without base)						Weight (when filled)	
		Length		Width		Height		oz	g
		(in.)	(mm)	(in.)	(mm)	(in.)	(mm)		
WT-PTORCH	Portable Heat-Shrink Torch	3.90	99.06	1.40	35.56	5.40	137.16	9.88	280.09

Electric heat gun



Product features

- UL® Listed
- 600° F to 950° F heat range
- Brass and steel construction provides durability
- 120VAC 60Hz

Electric heat gun



Cat. No.	Description	Pkg qty
WT1400	Dual-temp. heat gun 600° F/950° F, 1300W, 120VAC, 60Hz	1

Order multiple is std. pkg.

Technical information

Ocal PVC exterior coating chemical resistance

Solutions	Conc.	Temp. °C (F)	Recommended Exposure		
			Splashing	Liquid	Fumes
Acetic Acid	10%	49 (120)	no	no	no
Acid Copper Plating Solution		71 (160)	yes	yes	yes
Alkaline Cleaners		71 (160)	yes	yes	yes
Aluminum Chloride	Sat'd	71 (160)	yes	yes	yes
Aluminum Sulfate	Sat'd	71 (160)	yes	yes	yes
Alums	Sat'd	71 (160)	yes	yes	yes
Ammonium Chloride	Sat'd	71 (160)	yes	yes	yes
Ammonium Hydroxide	28%	49 (120)	yes	yes	yes
Ammonium Hydroxide	10%	49 (120)	yes	yes	yes
Ammonium Sulfate	Sat'd	71 (160)	yes	yes	yes
Ammonium Thiocyanate	Sat'd	71 (160)	yes	yes	yes
Amyl Alcohol	Any	32 (90)	yes	yes	yes
Arsenic Acids	Any	66 (150)	yes	yes	yes
Barium Sulfide	Sat'd	49 (120)	yes	yes	yes
Black Liquor	Sat'd	32 (90)	yes	yes	yes
Benzoic Acid	Sat'd	71 (160)	yes	yes	yes
Brass Plating Solution	Any	71 (160)	yes	yes	yes
Bromine Water	Sat'd	49 (120)	yes	yes	yes
Butyl Alcohol	Any	32 (90)	yes	yes	yes
Cadmium Plating Solution	Any	66 (150)	yes	yes	yes
Calcium Bisulfite	Any	66 (150)	yes	yes	yes
Calcium Chloride	Sat'd	71 (160)	yes	yes	yes
Calcium Hypochlorite	Sat'd	49 (120)	yes	yes	yes
Carbonic Acid	Sat'd	71 (160)	yes	yes	yes
Casein	Sat'd	32 (90)	yes	yes	yes
Castor Oil	Any	32 (90)	yes	yes	yes
Caustic Soda	35%	49 (120)	yes	yes	yes
Caustic Soda	10%	66 (150)	yes	yes	yes
Caustic Potash	35%	49 (120)	yes	yes	yes
Caustic Potash	10%	66 (150)	yes	yes	yes
Chlorine Water	Sat'd	32 (90)	yes	yes	yes
Chromium Plating Solution	Any	66 (150)	yes	yes	yes
Citric Acid	Sat'd	71 (160)	yes	yes	yes
Copper Chloride (Cupric)	Sat'd	71 (160)	yes	yes	yes
Copper Cyanide Plating Sol (High Speed)	Any Any	71 (160) 82 (180)	yes yes	yes yes	yes yes
(with Alkali Cyanides)	Sat'd	71 (160)	yes	yes	yes
Copper Sulfate	Sat'd	71 (160)	yes	yes	yes
Coconut Oil	Sat'd	32 (90)	yes	yes	yes
Cottonseed Oil	Sat'd	32 (90)	yes	yes	yes
Disodium Phosphate	Sat'd	71 (160)	yes	yes	yes
Ethyl Alcohol	Any	32 (90)	yes	yes	yes
Ethylene Glycol	Any	32 (90)	yes	no	yes
Ferric Chloride	45%	49 (120)	yes	yes	yes
Ferrous Sulfate	Sat'd	66 (150)	yes	yes	yes
Fluoboric Acid	Any	66 (150)	yes	yes	yes
Formaldehyde	37%	49 (120)	yes	yes	yes
Formic Acid	85%	38 (100)	no	no	no
Gallic Acid	Sat'd	66 (150)	no	no	yes
Glucose	Any	66 (150)	yes	yes	yes
Glue	Any	66 (150)	yes	yes	yes
Glycerine	Any	32 (90)	yes	yes	yes

Solutions	Conc.	Temp. °C (F)	Recommended Exposure		
			Splashing	Liquid	Fumes
Gold Plating Solution	Any	66 (150)	yes	yes	yes
Hydrochloric Acid	10%	49 (120)	yes	no	yes
Hydrochloric Acid	21.50%	49 (120)	yes	no	yes
Hydrochloric Acid	37.50%	49 (120)	yes	no	yes
Hydrochloric Acid	37.50%	32 (90)	yes	no	yes
Hydrofluoric Acid	4%	60 (140)	yes	no	yes
Hydrofluoric Acid	10%	49 (120)	yes	no	yes
Hydrofluoric Acid	48%	49 (120)	yes	no	yes
Hydrogen Peroxide	30%	49 (120)	yes	yes	yes
Hydrogen Sulfide	Sat'd	49 (120)	yes	yes	yes
Hydroquinone	Any	32 (90)	yes	yes	yes
Indium Plating Solution	Any	66 (150)	yes	yes	yes
Lactic Acid	50%	49 (120)	yes	yes	yes
Lactic Acid	Any	32 (90)	yes	yes	yes
Lead Plating Solution	Any	66 (150)	yes	yes	yes
Malic Acid	Any	32 (90)	yes	yes	yes
Methyl Alcohol	Any	32 (90)	yes	yes	yes
Mineral Oils	Any	32 (90)	yes	yes	yes
Nickel Acetate	Sat'd	71 (160)	yes	yes	yes
Nickel Plating Solution		71 (160)	yes	yes	yes
Nickel Salts	Sat'd	71 (160)	yes	yes	yes
Nitric Acid	35%	49 (120)	yes	no	yes
Nitric Acid	40%	32 (90)	yes	no	yes
Nitric Acid	60%	49 (120)	yes	no	yes
Nitric Acid/ Hydrofluoric Acid	15% 4%	60 (140)	yes	yes	yes
Nitric Acid/ Sodium Dichromate	16% 13%	54 (130)	yes	yes	yes
Water	71%				
Oleic Acid	Any	32 (90)	yes	yes	yes
Oxalic Acid	Sat'd	49 (120)	yes	yes	yes
	Any	32 (90)	yes	yes	yes
Phenol	Sat'd	49 (120)	no	no	no
Phosphoric Acid	75%	66 (150)	yes	yes	yes
Phosphoric Acid	85%	49 (120)	yes	yes	yes
Phosphoric Acid	85%	71 (160)	yes	yes	yes
Potassium Acid Sulfate	Sat'd	66 (150)	yes	yes	yes
Potassium Antimonate	Sat'd	66 (150)	yes	yes	yes
Potassium Bisulfite	Sat'd	32 (90)	yes	yes	yes
Potassium Chloride	Sat'd	71 (160)	yes	yes	yes
Potassium Cuprocyanide	Sat'd	66 (150)	yes	yes	yes
Potassium Cyanide	Sat'd	71 (160)	yes	yes	yes
Potassium Dichromate	Sat'd	71 (160)	yes	yes	yes
Potassium Hypochlorite	Sat'd	32 (90)	yes	no	yes
Potassium Sulfide	Sat'd	66 (150)	yes	yes	yes
Potassium Thiosulfate	Sat'd	66 (150)	yes	yes	yes
Propyl Alcohol	Sat'd	66 (150)	yes	yes	yes
Rhodium Plating Solution	Sat'd	66 (150)	yes	yes	yes
Silver Plating Solution	Sat'd	66 (150)	yes	yes	yes
Soaps	Any	32 (90)	yes	yes	yes
Sodium Acid Sulfate	Sat'd	71 (160)	yes	yes	yes
Sodium Antimonate	Sat'd	66 (150)	yes	yes	yes

Technical information

Ocal PVC exterior coating chemical resistance (continued)

Solutions	Conc.	Temp. °C (F)	Recommended Exposure		
			Splashing	Liquid	Fumes
Sodium Bicarbonate	Sat'd	71 (160)	yes	yes	yes
Sodium Bisulfite	Sat'd	32 (90)	yes	yes	yes
Sodium Chloride	Sat'd	71 (160)	yes	yes	yes
Sodium Cyanide	Sat'd	71 (160)	yes	yes	yes
Sodium Dichromate	Sat'd	71 (160)	yes	yes	yes
Sodium Hydroxide	10%	66 (150)	yes	no	yes
Sodium Hydroxide	35%	49 (120)	yes	no	yes
Sodium Hydroxide	73%	71 (160)	no	no	no
Sodium Hypochlorite	Sat'd	32 (90)	yes	no	yes
Sodium Hypochlorite	15%	49 (120)	yes	no	yes
Sodium Sulfide	Sat'd	66 (150)	yes	yes	yes
Sodium Thiosulfate	Sat'd	66 (150)	yes	yes	yes
Sulfuric Acid	15%	49 (120)	yes	yes	yes
Sulfuric Acid	15%	71 (160)	yes	yes	yes
Sulfuric Acid	50%	49 (120)	yes	yes	yes

Solutions	Conc.	Temp. °C (F)	Recommended Exposure		
			Splashing	Liquid	Fumes
Sulfuric Acid	70%	32 (90)	yes	no	yes
Sulfuric Acid	98%	38 (100)	no	no	yes
Sulfurous Acid	2%	49 (120)	yes	no	yes
Sulfurous Acid	6%	49 (120)	yes	no	yes
Tannic Acid	Sat'd	32 (90)	yes	yes	yes
Tartaric Acid	Sat'd	32 (90)	yes	yes	yes
Tin Chloride Aqueous	Sat'd	66 (150)	yes	yes	yes
Tin Plating Solution	Sat'd	66 (150)	yes	yes	yes
Triethaneolamine	Sat'd	66 (150)	yes	yes	yes
Trisodium Phosphate	Sat'd	66 (150)	yes	yes	yes
Water	Sat'd	71 (160)	yes	yes	yes
White Liquor		32 (90)	yes	yes	yes
Zinc Plating Solution		71 (160)	yes	yes	yes
Zinc Sulfate	Sat'd	71 (160)	yes	yes	yes

Ocal urethane interior coating chemical resistance

Solutions	Conc.	Temp. °C (F)	Recommended Exposure		
			Splashing	Liquid	Fumes
Acetic Acid	10%	24 (75)	yes	no	yes
Acid Copper Plating Solution	Any	24 (75)	yes	no	yes
Alkaline Cleaners	Any	24 (75)	yes	no	yes
Aluminum Chloride	Sat'd	24 (75)	yes	no	yes
Aluminum Sulfate	Sat'd	24 (75)	yes	no	yes
Alums	Sat'd	24 (75)	yes	no	yes
Ammonium Chloride	Sat'd	24 (75)	yes	no	yes
Ammonium Hydroxide	28%	24 (75)	yes	no	yes
Ammonium Hydroxide	10%	24 (75)	yes	no	yes
Ammonium Sulfate	Sat'd	24 (75)	yes	no	yes
Ammonium Thiocyanate	Sat'd	24 (75)	yes	no	yes
Amyl Alcohol	Any	24 (75)	yes	yes	yes
Arsenic Acids	Any	24 (75)	yes	no	yes
Barium Sulfide	Sat'd	24 (75)	yes	no	yes
Black Liquor	Sat'd	24 (75)	yes	no	yes
Benzoic Acid	Sat'd	24 (75)	yes	no	yes
Brass Plating Solution	Any	24 (75)	yes	no	yes
Bromine Water	Sat'd	24 (75)	yes	no	yes
Butyl Alcohol	Any	24 (75)	yes	no	yes
Cadmium Plating Solution	Any	24 (75)	yes	no	yes
Calcium Bisulfite	Any	24 (75)	yes	no	yes
Calcium Chloride	Sat'd	24 (75)	yes	no	yes
Calcium Hypochlorite	Sat'd	24 (75)	yes	no	yes
Carbonic Acid	Sat'd	24 (75)	yes	no	yes
Casein	Sat'd	24 (75)	yes	no	yes
Castor Oil	Any	24 (75)	yes	yes	yes
Caustic Soda	35%	24 (75)	yes	no	yes
Caustic Soda	10%	24 (75)	yes	no	yes

Solutions	Conc.	Temp. °C (F)	Recommended Exposure		
			Splashing	Liquid	Fumes
Caustic Potash	35%	24 (75)	yes	no	yes
Caustic Potash	10%	24 (75)	yes	no	yes
Chlorine Water	Sat'd	24 (75)	yes	no	yes
Chromium Plating Solution	Any	24 (75)	yes	no	yes
Citric Acid	Sat'd	24 (75)	yes	no	yes
Copper Chloride (Cupric)	Sat'd	24 (75)	yes	no	yes
Copper Cyanide Plating Sol	Any	24 (75)	yes	no	yes
(High Speed)	Any	24 (75)	yes	no	yes
(with Alkali Cyanides)	Sat'd	24 (75)	yes	no	yes
Copper Sulfate	Sat'd	24 (75)	yes	no	yes
Coconut Oil	Sat'd	24 (75)	yes	yes	yes
Cottonseed Oil	Sat'd	24 (75)	yes	yes	yes
Disodium Phosphate	Sat'd	24 (75)	yes	no	yes
Ethyl Alcohol	Any	24 (75)	yes	no	yes
Ethylene Glycol	Any	24 (75)	yes	yes	yes
Ferric Chloride	45%	24 (75)	yes	no	yes
Ferrous Sulfate	Sat'd	24 (75)	yes	no	yes
Fluoboric Acid	Any	24 (75)	yes	no	yes
Formaldehyde	37%	24 (75)	yes	no	yes
Formic Acid	85%	24 (75)	yes	no	yes
Gallic Acid	Sat'd	24 (75)	yes	no	yes
Glucose	Any	24 (75)	yes	yes	yes
Glue	Any	24 (75)	yes	no	yes
Glycerine	Any	24 (75)	yes	yes	yes
Gold Plating Solution	Any	24 (75)	yes	no	yes
Hydrochloric Acid	10%	24 (75)	yes	no	yes
Hydrochloric Acid	21.50%	24 (75)	yes	no	yes
Hydrochloric Acid	37.50%	24 (75)	yes	no	yes

Technical information

Ocal urethane interior coating chemical resistance (continued)

Solutions	Conc.	Temp. Recommended Exposure			
		°C (F)	Splashing	Liquid	Fumes
Hydrofluoric Acid	4.00%	24 (75)	yes	no	yes
Hydrofluoric Acid	10%	24 (75)	yes	no	yes
Hydrofluoric Acid	48%	24 (75)	yes	no	yes
Hydrogen Peroxide	30%	24 (75)	yes	no	yes
Hydrogen Sulfide	Sat'd	24 (75)	yes	no	yes
Hydroquinone	Any	24 (75)	yes	no	yes
Indium Plating Solution	Any	24 (75)	yes	no	yes
Lactic Acid	50%	24 (75)	yes	no	yes
Lactic Acid	Any	24 (75)	yes	no	yes
Lead Plating Solution	Any	24 (75)	yes	no	yes
Malic Acid	Any	24 (75)	yes	no	yes
Methyl Alcohol	Any	24 (75)	yes	no	yes
Mineral Oils	Any	24 (75)	yes	yes	yes
Nickel Acetate	Sat'd	24 (75)	yes	no	yes
Nickel Plating Solution		24 (75)	yes	no	yes
Nickel Salts	Sat'd	24 (75)	yes	no	yes
Nitric Acid	35%	24 (75)	yes	no	yes
Nitric Acid	40%	24 (75)	yes	no	yes
Nitric Acid	60%	24 (75)	yes	no	yes
Nitric Acid/ Hydrofluoric Acid	15% 4%	24 (75)	yes	no	yes
Nitric Acid/ Sodium Dichromate	16% 13%	24 (75)	yes	no	yes
Water	71%				
Oleic Acid	Any	24 (75)	yes	no	yes
Oxalic Acid	Sat'd	24 (75)	yes	no	yes
	Any	24 (75)	yes	no	yes
Phenol	Sat'd	24 (75)	yes	no	yes
Phosphoric Acid	75%	24 (75)	yes	no	yes
Phosphoric Acid	85%	24 (75)	yes	no	yes
Potassium Antimonate	Sat'd	24 (75)	yes	no	yes
Potassium Bisulfite	Sat'd	24 (75)	yes	no	yes
Potassium Chloride	Sat'd	24 (75)	yes	no	yes
Potassium Cuprocyanide	Sat'd	24 (75)	yes	no	yes
Potassium Cyanide	Sat'd	24 (75)	yes	no	yes
Potassium Dichromate	Sat'd	24 (75)	yes	no	yes
Potassium Hypochlorite	Sat'd	24 (75)	yes	no	yes

Solutions	Conc.	Temp. Recommended Exposure			
		°C (F)	Splashing	Liquid	Fumes
Potassium Sulfide	Sat'd	24 (75)	yes	no	yes
Potassium Thiosulfate	Sat'd	24 (75)	yes	no	yes
Propyl Alcohol	Sat'd	24 (75)	yes	no	yes
Rhodium Plating Solution	Sat'd	24 (75)	yes	no	yes
Silver Plating Solution	Sat'd	24 (75)	yes	no	yes
Soaps	Any	24 (75)	yes	no	yes
Sodium Acid Sulfate	Sat'd	24 (75)	yes	no	yes
Sodium Antimonate	Sat'd	24 (75)	yes	no	yes
Sodium Bicarbonate	Sat'd	24 (75)	yes	no	yes
Sodium Bisulfite	Sat'd	24 (75)	yes	no	yes
Sodium Chloride	Sat'd	24 (75)	yes	no	yes
Sodium Cyanide	Sat'd	24 (75)	yes	no	yes
Sodium Dichromate	Sat'd	24 (75)	yes	no	yes
Sodium Hydroxide	10%	24 (75)	yes	no	yes
Sodium Hydroxide	35%	24 (75)	yes	no	yes
Sodium Hydroxide	73%	24 (75)	yes	no	yes
Sodium Hypochlorite	Sat'd	24 (75)	yes	no	yes
Sodium Hypochlorite	15%	24 (75)	yes	no	yes
Sodium Sulfide	Sat'd	24 (75)	yes	no	yes
Sodium Thiosulfate	Sat'd	24 (75)	yes	no	yes
Sulfuric Acid	15%	24 (75)	yes	no	yes
Sulfuric Acid	50%	24 (75)	yes	no	yes
Sulfuric Acid	70%	24 (75)	yes	no	yes
Sulfuric Acid	98%	24 (75)	yes	no	yes
Sulfurous Acid	2%	24 (75)	yes	no	yes
Sulfurous Acid	6%	24 (75)	yes	no	yes
Tannic Acid	Sat'd	24 (75)	yes	no	yes
Tartaric Acid	Sat'd	24 (75)	yes	no	yes
Tin Chloride Aqueous	Sat'd	24 (75)	yes	no	yes
Tin Plating Solution	Sat'd	24 (75)	yes	no	yes
Triethaneolamine	Sat'd	24 (75)	yes	no	yes
Trisodium Phosphate	Sat'd	24 (75)	yes	no	yes
Water	Sat'd	24 (75)	yes	no	yes
White Liquor		24 (75)	yes	no	yes
Zinc Plating Solution		24 (75)	yes	no	yes
Zinc Sulfate	Sat'd	24 (75)	yes	no	yes

Technical information

Ocal guide specification:

Section 26 05 33 — Underground ducts and raceways for electrical systems: Conduit systems for use in corrosive environments

Part 1 – General

1.1 Summary

- A. Section Includes: Furnishing, installation and assembly of PVC-coated electrical rigid metal conduit (ERMC) systems and stainless steel fittings.
- B. Related Sections
 - 1. Section 26 05 29 – Hangers and Supports for Electrical Systems

1.2 References

- A. National Electrical Manufacturers Association (NEMA)
 - 1. NEMA RN 1: Polyvinyl-Chloride (PVC) Externally Coated Galvanized Rigid Steel Conduit and Intermediate Metal Conduit
- B. National Fire Protection Association (NFPA)
 - 1. NFPA 70: National Electrical Code® (NEC®)
- C. American Society for Testing and Materials (ASTM):
 - 1. ASTM A 239: Standard Practice for Locating the Thinnest Spot in a Zinc (Galvanized) Coating on Iron or Steel Articles
- D. Underwriters Laboratories, Inc. (UL)
 - 1. UL 6: Safety Standard for Rigid Metal Conduit
 - 2. UL 514B: Safety Standard for Fittings for Conduit and Outlet Boxes
- E. American National Standards Institute (ANSI)
 - 1. ANSI C80.1: American National Standard for Rigid Steel Conduit – Zinc Coated
- G. Steel Tube Institute of North America
 - 1. Guidelines for Installing Steel Conduit/Tubing

1.3 Submittals

- A. General: Submit in accordance with Section 01 33 00.
- B. Product Data
 - 1. Manufacturer's descriptive literature and product specifications for each product.
 - 2. Manufacturer's installation literature and training guide.
 - 3. Manufacturer's product drawings, when applicable.

1.4 Quality Assurance

- A. Manufacturer Qualifications: Products shall be free of defects in material and workmanship.
- B. Installer Qualifications: Installer shall be trained and certified based on the acceptable manufacturer's listed requirements.

Part 2 – Products

2.1 General

- A. Furnish PVC-coated ERMC of size as indicated. If not indicated, the smallest trade size shall be ¾ in. (19.05 mm) The PVC-coated ERMC system shall include necessary PVC-coated fittings, boxes and covers to form a complete encapsulated system.

2.2 Manufacturers

- A. Acceptable Manufacturers: ABB Corporation; 8155 T & B Blvd., Memphis, TN 38125. Tel: 901-252-5000. Web: www.tnb.com.
- B. Substitutions: Not permitted.
- C. Requests for substitutions will be considered in accordance with provisions of Section 01 25 00.

1.3 Materials/Components

A. Pvc-coated rigid steel conduit

The PVC-coated rigid steel conduit shall be hot dip galvanized inside and out with hot-dip galvanized threads. The interior galvanizing shall be listed per UL 6. The exterior galvanizing shall be listed per UL 6 as primary corrosion protection. Thread protectors shall be used on the exposed threads of the PVC-coated conduit. PVC-coated ERMC steel conduit shall comply with UL 6, ANSI C80.1 and NEMA RN 1 standards without exception.

The PVC coating, in compliance with NEMA RN 1, shall be nominal 40 mils (0,04 in.) in thickness continuous over the entire length of the conduit except at the threads and be free of blisters, bubbles or pinholes. PVC shall be UL listed as a primary corrosion protection.

A blue urethane coating shall be uniformly and consistently applied to the interior of conduit. This internal coating shall be a nominal 2 mils (0,002 in.) thickness. All male threads on elbows and nipples shall be protected by this same application of urethane coating.

Coated couplings shall be used with coated conduit. The thickness of the coating on couplings shall be at least equal to the thickness of the coating on the conduit. Each coated coupling shall have a flexible PVC sleeve which extends from each end of the coupling and which will overlap the PVC coating on the conduit when the coupling has been installed on the conduit.

Technical information

Ocal guide specification (continued):

The length of the sleeve extension(s) shall be at least equivalent to the nominal conduit size for sizes up through 2 in. For sizes 2–6 in., the length of the sleeve extension(s) shall be at least 2 in. The PVC sleeve shall be a nominal thickness of 40 mils in thickness. The inside diameter of the overlapping sleeve shall be less than the outside diameter of the PVC-coated conduit.

The PVC coating, in compliance with NEMA RN 1, shall be nominal 40 mils (0.04 in.)s in thickness continuous over the entire length of the conduit except at the threads and be free of blisters, bubbles or pinholes. PVC shall be UL listed as a primary corrosion protection.

A blue urethane coating shall be uniformly and consistently applied to the interior of conduit. This internal coating shall be a nominal 2 mils (0.002 in.) thickness. All male threads on elbows and nipples shall be protected by this same application of urethane coating.

Coated couplings shall be used with coated conduit. The thickness of the coating on couplings shall be at least equal to the thickness of the coating on the conduit. Each coated coupling shall have a flexible PVC sleeve which extends from each end of the coupling and which will overlap the PVC coating on the conduit when the coupling has been installed on the conduit.

B. PVC-coated rigid steel conduit

The PVC-coated ERM aluminum conduit prior to coating shall be UL listed. The exterior of the conduit shall have a PVC coating of a minimum thickness of nominal 40 mils (0.04 in.).

A blue urethane coating shall be uniformly and consistently applied to the interior of conduit. This internal coating shall be a nominal 2 mils (0.002 in.) thickness. All male threads on elbows and nipples shall be protected by this same application of urethane coating.

Coated couplings shall be used with coated conduit. The thickness of the coating on couplings shall be at least equal to the thickness of the coating on the conduit. Each coated coupling shall have a flexible PVC sleeve which extends from each end of the coupling and which will overlap the PVC coating on the conduit when

the coupling has been installed on the conduit. The length of the sleeve extension(s) shall be at least equivalent conduit size for sizes up through 2 in. For sizes 2–6 in., the length of the sleeve extension(s) shall be at least 2 in. The PVC sleeve shall be a nominal thickness of 40 mils (0.04 in.) in thickness. The inside diameter of the overlapping sleeve shall be less than the outside diameter of the PVC-coated conduit.

C. PVC-coated ordinary location fittings

PVC-coated ferrous and aluminum fittings for general service and corrosive locations must be UL listed. The PVC coating shall be minimum 40 mils in thickness and be free of blisters, bubbles or pinholes. Female threads on fittings shall be protected by application of urethane coating.

All female ends of PVC-coated conduit fittings shall have a flexible PVC sleeve which extends from the female ends of the fitting and which will overlap the PVC coating on the conduit when the fitting has been installed on the conduit. The length of the sleeve extension(s) shall be at least equivalent to the nominal conduit size for sizes up through 2 in. For sizes 2–6 in., the length of the sleeve extension(s) shall be at least 2 in. The PVC sleeve shall be a nominal thickness of 40 mils (0.04 in.) in thickness. The inside diameter of the overlapping sleeve shall be less than the outside diameter of the PVC-coated conduit.

1. The PVC coating on all form 8 covers shall form a gasketlike flange of at least 5/16 in. wide and minimum 40 mils (0.04 in.) covering the top of the fitting around the opening and the bottom of the cover/matting with the flange of the fitting. A blue urethane coating shall be uniformly and consistently applied to the interior, exterior and threads of all conduit bodies, including but not limited to form 8 and form 7 conduit bodies. This coating shall be a nominal 2 mils thickness. Stainless steel encapsulated screws shall be Supplied with all form 7 and form 8 fittings.

Technical information

Ocal guide specification (continued):

2. Rigid hubs shall have a nominal 40 mils (0.04 in.) PVC coating thickness with a nominal 2 mils of blue urethane on interior and threads. The male threads and locknut shall remain uncoated.
3. Liquidtight fittings shall have an exterior PVC coating of a minimum thickness of nominal 40 mils (0.04 in.).

D. PVC-coated hazardous location fittings

Hazardous location fittings prior to PVC coating must be UL listed. All female ends of PVC-coated conduit fittings shall have a flexible PVC sleeve which extends from the female ends of the fitting and which will overlap the PVC coating on the conduit when the fitting has been installed on the conduit. The length of the sleeve extension(s) shall be at least equivalent to the nominal conduit size for sizes up through 2 in. For sizes 2–6 in., the length of the sleeve extension(s) shall be at least 2 in. The PVC sleeve shall be a nominal thickness of 40 mils (0.04 in.) in thickness. The inside diameter of the overlapping sleeve shall be less than the outside diameter of the PVC-coated conduit.

E. PVC-coated strut, hangers and clamps

Right-angle beam clamps and U-bolts shall be specially formed and sized to fit snugly the outside diameter of the PVC-coated conduit. Support products such as ferrous strut, beam clamps, pipe straps, clamp back spacers, conduit clamp hangers and all-thread rods shall have a minimum 15 mils (0.015 in.) PVC coating by the manufacturer of the ERM conduit and system components.

F. Stainless steel fittings

Stainless steel liquid-tight fittings shall be made of 304-grade stainless steel or better.

G. Stainless steel strut, hangers, etc.

Stainless steel strut, beam clamps, pipe straps, clamp back spacers, conduit clamp hangers and all-thread rods shall be made of 304-grade stainless steel or better.

Part 3 – Execution

3.1 Examination

- A. The PVC-coated ERM conduit and system components have been selected for use in an atmosphere considered to be corrosive for this project. The corrosive atmosphere is considered to be more damaging than merely the presence of moisture. Accordingly, conduit and the corresponding fittings for it must have PVC protection as described under Part 2 – Products. Conduit and fittings that are merely galvanized for this purpose are insufficient.

3.2 Preparation

- A. Preparation shall be done in accordance with manufacturer's printed instructions.

3.3 Installation

- A. Install in accordance with manufacturer's printed instructions and manufacturer's installation training.

3.4 Quality control

- A. General:
Comply with requirements of Section 01 45 13.

3.5 Manufacturer's field services

- A. Free on-site installation training course by company representative. This representative must conduct the on-site training course in order to qualify for the installation certificate. The time required for this training is estimated to be two (2) hours.
- B. After the on-site training installation, the representative shall then register the installer in his database and provide certification for installation.

End of section

Notes

1. Ocal PVC-coated conduit and fittings are not recommended for use in areas where they will be exposed to sustained temperatures above 200 °F (93°C) or exposed to fire. Prolonged exposure to heat greater than 200°F (93°C) or exposure to fire may cause the plastic coatings to release harmful emissions, posing a potential health hazard to persons subjected to such emissions.
2. If subjected to sustained flame or sustained heat above 400 °F (204°C), PVC will burn. PVC is self-extinguishing at room temperature.

Technical information

Recommended installation procedures

PVC-coated conduit is installed in much the same manner as conventional rigid galvanized steel conduit; however, certain precautions must be taken to protect the exterior coating and ensure satisfactory results. By following these guidelines and using the proper tooling, a damage-free installation can be achieved.

When an engineer has specified Ocal PVC-coated conduit, the intent is for the total run to be PVC coated. There are no exceptions to this rule. This means from the beginning of the run to its completion and all in between, no exposed metal shall be allowed.

Clamping in a yoke-style vise



Ocal jaw vise adapters
JAWS23
See page F60



The first step is the correct clamping of the PVC-coated conduit.

When you use a yoke-style vise, you should replace both the upper and lower jaw inserts with the specially designed Ocal jaw vise adapters. These adapters provide greater clamping force and prevent the pipe from spinning during the threading process. (See Catalog No. JAWS23 on page F60).

Clamping in a chain-style vise



Chain-style vise
Ridgid Tools 460-6
See page F59

If a chain-style vise is used, the chain – as well as the jaw inserts – will tear the PVC coating when the threading force is applied.

To prevent this from happening, installers sometimes make “shells” from PVC pipe or standard rigid steel conduit that fit over the PVC-coated conduit. To save time and obtain more consistency, longer life and better protection, you can use the Ocal half-shell clamps.

Available in trade sizes ½" to 6", Ocal half-shell clamps are made from ductile iron for superior strength and durability. They feature a cross-hatched interior surface designed to safeguard the PVC coating while holding the conduit securely in a chain-style vise.

Half-Shell Clamp Sets
HLF-SHL-CLP-SET1



Half-Shell Clamps
for conduit sizes ½" to 6"
HLF-SHL-CLP-

Technical information

Cutting with a band saw cutter

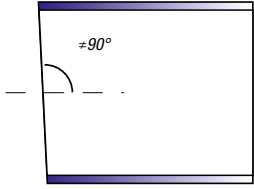

A band saw cutter will cut the PVC coating flush with the end of the conduit. PVC material cut flush to the end of the conduit will not allow the die teeth to bite into the steel to start the threading process.

Therefore, before threading, you must remove approximately $\frac{1}{4}$ " of the PVC coating from the end of the conduit. Using a knife, whittle in a pencil-sharpening style, cutting the coating from the conduit. A wire brush may also be used to remove PVC coating.

A band saw cutter usually will not cut the conduit at a "perfect" 90° angle (the accuracy of this cut depends heavily on the skill of the operator).



Cutting with a roller-style cutter

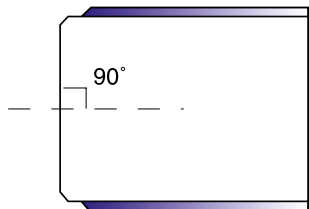

Steel Pipe Cutters
P70045C, P70060C

Although most personnel in the field prefer a band saw cutter, a roller-style cutter is the recommended tool for cutting Ocal PVC-coated conduit.

A roller-style cutter cuts the edge of the conduit at a bevel and removes $\frac{1}{4}$ " of the coating at the same time. In addition, a roller-style cutter provides an exact 90° cut in relation to the conduit. No additional removal of PVC coating is necessary.



Technical information

Manual and hand-held threading



51862

PVC-coated conduit has a larger O.D. than uncoated conduit. Standard dies will not clear the additional thickness. Hand-held as well as power threading devices require a die head for the correct size conduit. The standard die head is factory set for rigid conduit and will not fit over PVC coating.

These die heads are available from Ocal, machined for use with PVC-coated conduit. You can have standard dies machined as well.

If you have dies machined, you will need to adhere to the following procedure:

1. Remove the cover plate and the four die teeth.
2. Have the machinist remove 100 thousandths of an inch ($1/10''$) from the throat and collar diameter of the die head.
3. Replace the dies and cover.

Ridgid Tools #700 threader
See page F59

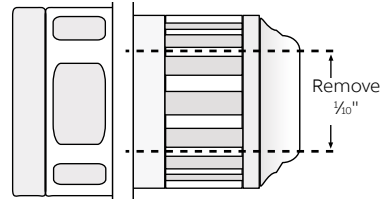

01 Throat & Collar Shown

02 Cover Plate Shown

03 The die teeth are cutting tapered threads and will become clogged with PVC and metal shavings.

04 To prevent clogging, use a knife and score the conduit lengthwise from the point where the threads will end to where they begin. This will allow the PVC and metal shavings to fall into the throat of the die head.



01



02



03



04



Technical information

Hand-held powered threading



Handheld

The Ridgid #12R is typically used for smaller size conduit. The ratchet knob indicates forward and reverse. Die heads snap in from both sides and lock in place. (#12R includes ratchet and handle only)

Handheld powered

The Ridgid 700 Power Drive is a heavy duty handheld tool typically used for conduit up to 2 inches diameter. The 700 Power Drive is designed for Ridgid 12R dies, available in both 115V and 230V models. Optional case is available for this tool.



Rothenberger Reamer
70289
See page F70

01 Ream the conduit with approved reamers. Spiral and straight-style reamers are both acceptable.

02 Ocal Urethane Patching Compound
See pages F63-F64

03 KOPR-SHIELD®
See page F62



01



02



03

Technical information

Geared threading



Ridgid #700 threader
See page F59



Geared Threader ("Hog Head")

Geared threaders will thread 2½" through 6" PVC coated conduit. However, geared threaders are typically only used for 5" and 6" conduit. The cutting dies are adjustable and will not require pencil cutting the conduit.

The geared threader requires a clamp screw to secure the conduit, and the clamp screw will penetrate the PVC coating. Make certain the clamp screw is tight; otherwise, it will slip around the conduit and tear the coating. After the threading process is complete, touch up the penetrated area with Ocal exterior PVC patching compound (see pages F63–F64).

Ream the conduit and dress the threads as previously described.

Stationary power threading



Ridgid Tools 1224
threader
See page F58

Stationary power threading machines such as Ridgid model number 1224 have the capacity to thread rigid conduit from ½" to 4".

The standard jaw inserts with these units are intended to secure un-coated rigid conduit. The teeth of the standard jaw inserts will penetrate the PVC coating, but not bite into the steel. As a result, the standard jaw inserts will grind the PVC coating off of the conduit. To prevent this, shell style clamps or jaw inserts for coated conduit may be used.

Jaw inserts for coated conduit – Range: 1/2" to 4"
The jaw inserts for coated conduit have a wider surface area to effectively grip the PVC coating. Ridgid Catalogue No. 26247 is the jaw insert for coated conduit used in the Ridgid 1224 threading machine.

Technical information

Bending and hand bending



Chicago Bender



Hand Bender
See page F57

Bending

Never use any type of lubricant on the shoes. Use rubbing alcohol to clean the shoe prior to bending

Hand bending

A standard hand bender can be used for saddles, offsets and conventional bending. For PVC-coated conduit, the next larger shoe size from the EMT size should be used. The chart below shows the catalog numbers of the hand benders on page F53 and the corresponding size of PVC-coated conduit on which they should be used.



Ocal Air-Cure
Patching Compounds
See page F63



Ocal Heat-Cure Patch
See page F64

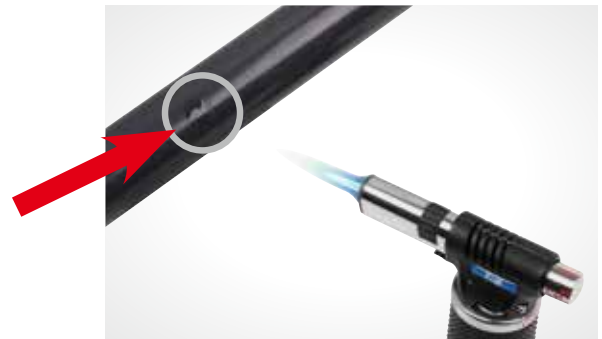

Ocal Heat-Cure Patch offers a thicker consistency at higher ambient temperatures than standard air-cure compounds, ensuring better coverage and a more effective patch in warm weather applications.

Cat. No.	PVC-Coated Conduit Size (mm)
35220	1/2"
35225	3/4"
2424A8	1"

Technical information

Electric bending



Greenlee® Model 555 Bender and bending accessories for PVC-coated conduit (below)

These machines are designed for bending 1/2" through 2" conduit. The shoes as well as the roller assembly should be of the design for use with PVC-coated conduit. Listed along with the Greenlee® electric bender on page F78 are the bending accessories to equip the machine for PVC-coated conduit.

If you use conventional shoes on an electric bender, the shoes and each of the rollers in the roller assembly must be machined 60 thousandths. Some manufacturers use slide bars instead of a roller assembly, and these, too, must be machined 60 thousandths. Be sure to compensate for "spring back," since PVC coating often requires the setting to be off as much as 5°.

Hydraulic bending

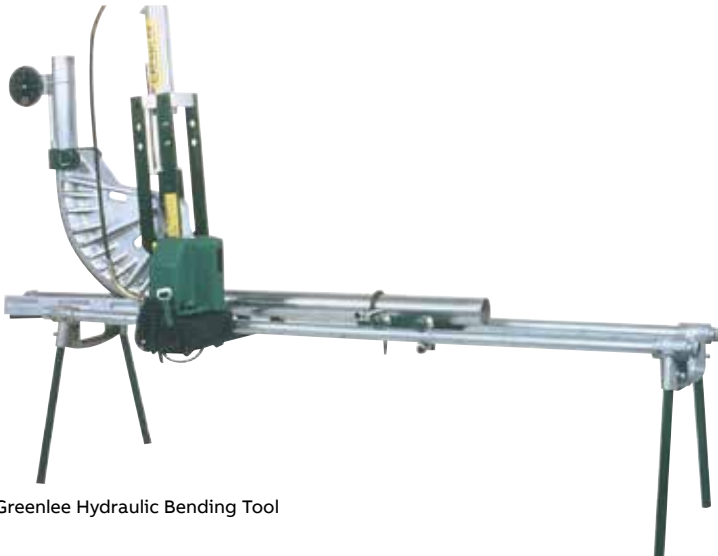

Greenlee Hydraulic Bending Tool

This is the preferred style of bending for 2 1/2" and larger size conduit. The shoe assembly should be of the design for PVC-coated conduit. The roller wheel and/or slide bar will accommodate PVC-coated conduit without the need for machining.

Note

Sequential bends can be manufactured by Ocal upon request. 5" and 6" conduit must be bent at the factory.



Shoe for Greenlee Hydraulic Bending Tool

Technical information

NEMA Standards Publication No. RN 1–2005

Section 3 – External coatings

3.1 Thickness

The thickness of polyvinyl chloride (PVC) coatings shall be a nominal .040 in. (1.02mm). The tolerance on the coating thickness shall be +.010 in. (.25mm) or -.005 in. (.13mm).

3.2 Coating Material

The PVC coating shall have the properties specified in Table 3.1.

Properties of PVC coatings – Table 3.1

Property	Minimum Requirement	ASTM Test Method
Hardness:		
Shore A	75	D 2240
Shore D	25	D 2240
Tensile Strength	2,000 psi	D 638
Elongation	200%	D 638
Dielectric Strength	325 volts per mil	D 149
Brittleness Temperature	5° F	D 1790

3.3 Application of coating

3.3.1 Cleaning

The exterior surface that is to receive the coating shall be free of grease, oil, dirt and other extraneous matter. The surface shall be cleaned in such a manner that the galvanized surface of the conduit is not harmed or eroded.

3.3.2 Priming

The cleaned exterior surface shall be primed with an adhesive suitable for use with the PVC coating material to be applied.

3.3.3 Coating

The PVC material shall be applied in powder, plastisol or pellet form by a manufacturing method which will produce a finished product conforming to these standards.

3.4 Elbows

Coated elbows shall be used with coated conduit. The thickness of the coating on elbows shall be in accordance with Section 3.1.

3.5 Couplings

Coated couplings shall be used with coated conduit. The thickness of the coating on couplings shall be at least equal to the thickness of the coating on the conduit.

Each coated coupling shall have a flexible PVC sleeve which extends from each end of the coupling and which will overlap the PVC coating on the conduit when the coupling has been installed on the conduit.

The length of the sleeve extension(s) shall be at least equivalent to the nominal conduit size for sizes up through NPS 2 (53). For sizes NPS 2½ (63) through NPS 6 (155), the length of the sleeve extension(s) shall be at least 2 in. (50.8mm).

The PVC sleeve shall be a nominal thickness of .040 in (1.02mm). The inside diameter (I.D.) of the overlapping sleeve shall be less than the outside diameter (O.D.) of the PVC-coated conduit.

3.6 Workmanship and appearance

The PVC coating shall be free of blisters, bubbles and pinholes. The PVC coating shall be continuous over the entire length of the conduit except at the threads and shall be holiday-free at the time of manufacture.

A holiday is herein defined as an electrical discontinuity of less than 80,000 ohms equivalent resistance sensed with a cellulose sponge wet with a suitable electrolyte and measured with an appropriate low voltage directcurrent instrument.

A suitable electrolyte is a solution containing tap water, 3.0% salt (sodium chloride) and .5% liquid detergent.

The inside of the PVC-coated conduit, couplings and elbows shall be free of the PVC coating material.

All sleeve extensions shall be square cut.

3.7 Performance requirements

Typical physical requirements for PVC-coated conduit are given in Table 3.2.

Typical physical properties of PVC-coated rigid conduit and IMC– Table 3.2

Property	Requirement*	Test Method
Abrasion Resistance	200 hours, no failure	ASTM G6
Bendability, radius (at 73.4° ± 1.8°F) (at 23° ± 16.8°F)	9 in. (228.6mm)	ASTM G10
Artificial Weathering	Minimum 1,000 hours, no adverse effect	ASTM G153

* The above requirements are based on testing a .040 in. (1.02mm) PVC coating applied over NPS ¾ inch galvanized rigid steel conduit. See Section 1 for information on the ASTM test methods.

3.8 Adhesion

The adhesion of the PVC coating to the conduit shall be greater than the strength of the coating itself. This shall be determined by making two circumferential cuts, above ½ in. (12.7mm) apart, through the plastic to the substrate. A third cut shall be made perpendicular to and crossing the circumferential cuts. The edge of the plastic shall be carefully lifted with a knife to form a plastic tab. This tab shall be pulled perpendicular to the conduit with a pair of pliers. The plastic tab shall tear rather than any additional coating film separating from the substrate.