

## Rigid and intermediate metal conduit fittings

### Locknuts

—  
01 140 Series  
141AL Series  
—  
02 106 Series

#### Application

- To connect externally threaded conduit or fitting to a threadless opening in a box or enclosure
- To effectively bond conduit or fitting to box or enclosure

#### Features

- Hardened steel/malleable iron/copper-free aluminum construction
- Tightens without deformation
- Locknuts specially designed to
  - (1) Provide extended reach for clamping on thin boxes and enclosures
  - (2) Cut through protective coating on box and enclosure, thereby ensuring ground continuity
  - (3) Permit tightening from outside
  - (4) Prevent loosening under vibration
- 106 Series provided with a hardened cone point screw

#### Standard material

##### 140 series and 106 series

- $\frac{3}{8}$  in. through 2 in. steel (hardened)
- 2½ in. through 6 in. malleable iron
- All screws steel

##### 141AL series

- All copper-free aluminum (less than 0.4% copper)

#### Standard finish

- All steel and malleable iron locknuts including bonding screws electro-zinc plated; all aluminum locknuts degreased.

#### Range

- $\frac{3}{8}$  in. through 6 in. conduit (all threads straight pipe [NPS]) (140 series)
- $\frac{1}{2}$  in. through 4 in. conduit (106 series and 141AL series)

#### Conformance

- UL 514B
- CSA C22.2 No. 18.3
- NEMA FB-1
- ANSI C80.4
- Federal Specification W-F-408
- Federal Standard H-28 (threads)

#### Case-hardened locknuts

Case-hardened locknuts make fittings faster and easier to install. Case-hardened locknuts do not slip or turn, thereby protecting the biting edge. Case-hardened locknuts bite through the paint on the enclosure, providing excellent continuity of ground (typical T&B fitting with case-hardened locknuts successfully passed minimum fault current of 10,000 amps RMS). Case-hardened locknuts when assembled in the intended manner will not vibrate loose, thereby ensuring excellent ground continuity.



—  
01



—  
02

## Rigid and intermediate metal conduit fittings

### Locknuts

#### Steel or malleable iron (steel through 2 in.) or aluminum 624

Many of the standard conduit and cable fittings are furnished with case-hardened locknuts. This

exclusive feature means the locknut tightens up against the box without deforming; the locknut bites into the box, providing a positive ground; and the fitting can be tightened from outside the box.

#### Locknuts



	Cat. no.			Dimensions (in.)		
	Stl. or M.I.	Alum.	SST	Size (in.)	A	B
	139*†	–	–	¼	27/32	5/32
	140*	–	–	¾	15/16	5/32
	141**	141AL	141SST	½	17/64	5/32
	142-TB**	142AL	142SST	¾	1¾	3/16
	143	143AL	143SST	1	1 11/16	13/64
	144	144AL	144SST	1¼	2 5/32	13/64
	145	145AL	145SST	1½	2½	13/64
	146-TB	146AL	146SST	2	3	7/32
	147	147AL	–	2½	3 9/16	13/32
	148	148AL	–	3	4 3/16	13/32
	149	149AL	–	3½	4 13/16	15/32
	150	150AL	–	4	5 5/16	15/32
	151	151AL	–	4½	5 15/16	17/32
	152	152AL	–	5	6½	17/32
	153	153AL	–	6	7¾	17/32

\* Hex shape

\*\* Case-hardened locknuts

Aluminum locknuts comply with federal standard of copper-free aluminum; less than 0.4% copper

† Not UL listed or CSA certified

#### Steel or malleable iron (steel through 2 in.)

Use anywhere an ordinary locknut is installed to ensure positive bonding of conduit to box and prevent loosening due to vibration. Also can be

used for service entrance applications in conformance with code. T&B rigid conduit and EMT (thinwall) fittings comply with Federal Specification WF 408C.

#### Bonding locknuts



	Cat. no.			Dimensions (in.)	
	Size (in.)	Screw Size (in.)	A	B	
	106	½	8-32 x 7/16	1¾	0.125
	107	¾	8-32 x 7/16	1¾	0.140
	108	1	8-32 x 7/16	1 15/16	0.170
	109	1¼	8-32 x 7/16	2 5/32	0.170
	110-TB	1½	8-32 x 7/16	2½	0.170
	111	2	8-32 x 7/16	3	0.187
	112-TB	2½	¾-20 x 5/8	3 13/32	0.375
	113-TB	3	¾-20 x 5/8	4 13/16	0.375
	114	3½	¾-20 x 5/8	4 29/32	0.438
	115-TB	4	¾-20 x 5/8	5 7/16	0.438

Steel finish: zinc plated

## Rigid and intermediate metal conduit fittings

### Sealing rings



#### Molded Santoprene seal / colour: blue

Provides positive seal against water and oil. For use with rigid and intermediate metal conduit, or fittings to provide watertight or raintight seal at all enclosures. NPS threads.

#### Fittings



Diagram	Cat. no.	Size (in.)	Dimensions (in.)		
			A	B	C
	141SL	1/2	1.140	1/8	1/4
	142SL	3/4	1.420	5/32	9/32
	143SL	1	1.770	11/64	9/32
	144SL	1 1/4	2.281	11/64	5/16
	145SL	1 1/2	2.598	11/64	9/32
	146SL	2	3.175	3/16	19/64

Steel finish: zinc plated

#### Sealing ring – Santoprene thermoplastic rubber

These sealing rings provide a liquidtight, dust-tight seal of fitting at enclosures.

#### Sealing rings with stainless steel retainer



Diagram	Cat. no.	Conduit size (in.)	Dimensions (in.)	
			A	B ± 1/64
	5302	1/2	1 11/64	3/4
	5303	3/4	1 1/2	15/16
	5304-TB	1	1 3/4	1 11/64
	5305	1 1/4	2 9/64	1 1/2
	5306	1 1/2	2 27/64	1 3/4
	5307	2	2 59/64	2 15/64
	5308	2 1/2	3 7/16	2 43/64
	5309	3	4 5/64	3 19/64
	5311	4	5 9/32	4 19/64

NEMA 3R, 4, 6 and 13

## Rigid and intermediate metal conduit fittings

### Bonding and grounding wedges



#### Application

- To effectively bond terminating fitting or conduit to a box or enclosure

#### Features

- Sizes 3/4 in. through 6 in. equipped with an additional bonding screw to install bonding jumper where required
- Can be added to an existing installation without disconnecting conductors

#### Standard material/finish

- 1/2 in. size:
  - Steel/electro-zinc plated
- 3/4 in. through 6 in. size:
  - Bronze/tin plated

#### Range

- 1/2 in. through 6 in. conduit

#### Conformity

- UL 467
- CSA C22.2 No. 41
- NFPA70-2008 (ANSI)
- Federal Specification A-A-50552

Especially suited for grounding old work, but equally convenient for new, grounding wedges provide grounding without a jumper except in concentric knockouts. When a jumper is required, it fits under a set screw in the grounding wedge.

Update existing installations to meet code requirements for bonding (CEC Section 10-806) without disconnecting wiring. Use on new wiring also.

1. Loosen bushing and position wedge
2. Tighten bushing and bonding screw

### Bonding and grounding wedges

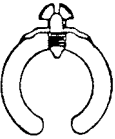
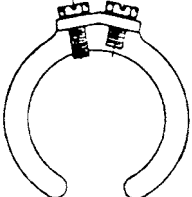

	Cat. no.	Size (in.)
Series 3650 	3650	1/2
	3651	3/4
	3652	1
	3653	1 1/4
	3654	1 1/2
	3655	2
Series 3651 	3656	2 1/2
	3657	3
	3658	3 1/2
	3659	4
	3661	5
	3662	6

## Rigid and intermediate metal conduit fittings

### Blackjack® – Conduit grounding bushings

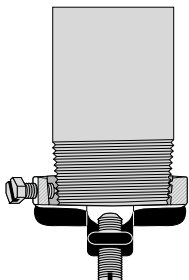

#### Innovative design makes installation quicker, easier.

The Blackjack grounding bushing never has to be threaded onto a conduit. It is simply placed in position on either a threaded or non-threaded rigid or IMC conduit, with the grounding lug in perfect position to accept the grounding wire. Even in tight installations, it's as simple as one, two, three.

Compare the installation with conventional bushings that must be threaded onto the conduit. In tight areas, you may have to remove the grounding lug, keep up with the loose parts and then reattach the lug. Then you still have to twist and turn the bushing to get the lug in position to accept the grounding wire. The Blackjack bushing does away with these needless delays for good, making it the ideal grounding bushing and the only logical choice for small spaces, corners and multiple conduit runs. And, because the grounding lug is an integral part of the bushing, it is designed not to fall off or get lost.

#### Innovative design improves performance.

##### The Blackjack bushing provides superior ground continuity.

The design of the Blackjack bushing has an integral, cast-on grounding lug for better ground continuity. This means that the Blackjack bushing stands up to intense loads.

#### Secure grip forms lasting bond.

The Blackjack bushing's cone point mounting screw bites securely into both threaded and non-threaded rigid conduit. And the Blackjack bushing's nylon locking patch is designed to prevent the screw from loosening due to vibration.

#### Reduce inventory.

Because the Blackjack grounding bushing is designed for threaded and non-threaded conduit, and the ground lugs are designed to handle an extended range, the number of parts in inventory is reduced by up to two-thirds without losing any application coverage.

#### Lug screw:

- 14-4: Slotted
- 14-2/0: Slotted
- 6-4/0: Internal hex drive

#### Standard material/finish

- Body: Malleable iron or aluminum
- Mounting screw: (½ in.-2 in.) stainless steel, (2½ in.-6 in.) brass
- Lug screw: Stainless steel
- Finish: Zinc plated or mechanical galvanized

#### Range

- Conduit: ½ in. through 6 in. threaded or threadless rigid/IMC
- Wire range: #14 AWG to 4/0 AWG Cu/Al

#### Conformity

- UL 514B and UL 467
- CSA C22.2 No. 18.3 and CSA C22.2 No. 41

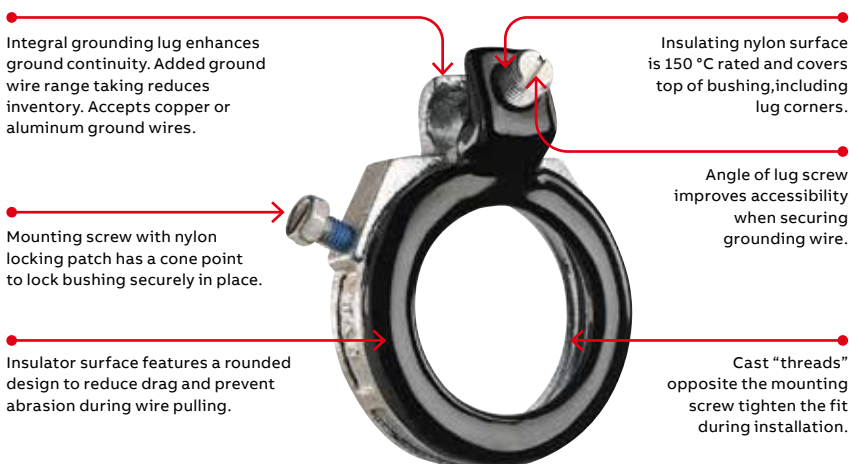

# Rigid and intermediate metal conduit fittings

## Blackjack® – Conduit grounding bushings

### Blackjack® – Conduit grounding bushings



Cat. no. zinc plated malleable iron	Aluminum	Conduit size (in.)	ØA Max.	ØB Max.	ØC Max.	ØD Max.	Dim.	
							E Max.	Wire range
BG050-14-20	BGA050-14-20	½	1.251	0.569	1.181	2.134	0.696	14-2/0
BG050-14-4	BGA050-14-4	½	1.251	0.569	1.027	1.940	0.696	14-4
BG075-14-20	BGA075-14-20	¾	1.533	0.772	1.221	2.414	0.696	14-2/0
BG075-14-4	BGA075-14-4	¾	1.533	0.772	1.030	2.168	0.696	14-4
BG100-14-20	BGA100-14-20	1	1.783	0.993	1.181	2.581	0.696	14-2/0
BG100-14-4	BGA100-14-4	1	1.783	0.993	1.027	2.368	0.696	14-4
BG125-14-20	BGA125-14-20	1¼	2.220	1.319	1.181	2.987	0.759	14-2/0
BG150-14-20	BGA150-14-20	1½	2.470	1.553	1.181	3.236	0.696	14-2/0
BG200-14-20	BGA200-14-20	2	2.830	2.010	1.181	3.766	0.696	14-2/0
BG250-14-20	BGA250-14-20	2½	3.148	2.412	1.181	4.341	0.978	14-2/0
BG250-6-40	BGA250-6-40	2½	3.148	2.412	1.524	4.526	0.978	6-4/0
BG300-14-20	BGA300-14-20	3	4.042	3.022	1.181	4.966	0.978	14-2/0
BG300-6-40	BGA300-6-40	3	4.042	3.022	1.524	5.139	0.978	6-4/0
BG350-14-20	BGA350-14-20	3½	4.542	3.491	1.181	5.467	0.978	14-2/0
BG350-6-40	BGA350-6-40	3½	4.542	3.491	1.524	5.639	0.978	6-4/0
BG400-14-20	BGA400-14-20	4	5.042	3.975	1.181	5.966	0.978	14-2/0
BG400-6-40	BGA400-6-40	4	5.042	3.975	1.524	6.139	0.978	6-4/0
BG500-14-20	BGA500-14-20	5	6.136	4.991	1.181	7.045	0.978	14-2/0
BG500-6-40	BGA500-6-40	5	6.136	4.991	1.524	7.207	0.978	6-4/0
BG600-14-20	BGA600-14-20	6	7.199	6.009	1.181	8.087	0.978	14-2/0
BG600-6-40	BGA600-6-40	6	7.199	6.009	1.524	8.409	0.978	6-4/0

Suggested specifications  
Insulated grounding and bonding bushing  
(Series BG050-BG600)

Where code requires bonding and grounding of single or multiple metal conduit, or positive bonding and grounding of metal conduit to the box, enclosure or auxiliary gutter, the end of the conduit shall be equipped with an insulated metallic grounding and bonding bushing series BG050-14-20 as manufactured by ABB.

Grounding and bonding bushings used shall be approved for the purpose and

- (i) Shall be of malleable iron/steel/aluminum construction adequately protected against corrosion.
- (ii) Bushing insulator shall be listed or certified for 150 °C/302 °F application with a flammability rating of 94V-0. Insulator must be positively locked in place.

\* Mechanical galvanization is available in the 3870 series; add suffix MG to cat. no.

### Diagrams

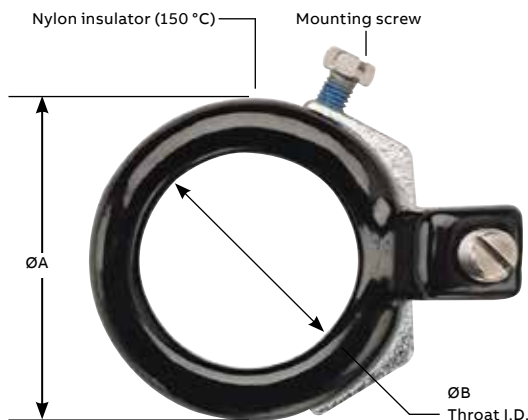

## Rigid and intermediate metal conduit fittings

### Threaded insulated grounding bushings



#### Application

- For quick installation of bonding jumper to multiple metal conduit (rigid and IMC)
- Designed to bush conductors and prevent insulation damage

#### Features

- Ease of installation, lay-in lug design
- Cast malleable iron body designed to lock insulator in place within body, reducing common assembly problem resulting in dislodging of insulator
- Insulator rated for 150 °C/302 °F application

#### Standard material / finish

- Body: Electro-zinc plated
- Lay-in lug: Aluminum/tin-plated
- Insulator: Thermoplastic 150 °C/302 °F
- Application with 94V-0 flammability

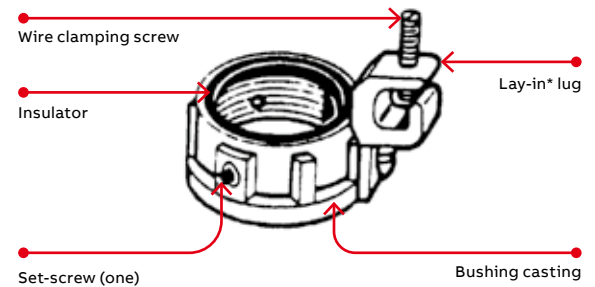

Cat. no.	Conduit size (in.)	Bushing dia. (in.)	Throat dia. (in.)	Lug length (in.)	Swing radius (in.)	Bushing height (in.)	Wire range AWG Cu/Al
3870-TB	½	1.125	0.560	1.310	1.212	0.657	14-4
3861	½	1.125	0.560	1.675	1.402	0.657	8-2/0
3871-TB	¾	1.420	0.742	1.310	1.360	0.660	14-4
3862	¾	1.420	0.742	1.675	1.550	0.660	8-2/0
3872	1	1.770	0.944	1.310	1.535	0.735	14-4
3882	1	1.770	0.944	1.675	1.725	0.735	8-2/0
3873	1¼	2.190	1.242	1.310	1.745	0.735	14-4
3883	1¼	2.190	1.242	1.675	1.935	0.735	8-2/0
3874	1½	2.468	1.449	1.310	1.884	0.770	14-4
3884	1½	2.468	1.449	1.675	2.074	0.770	8-2/0
3875	2	3.031	1.860	1.310	2.165	0.770	14-4
3889	2	3.031	1.860	1.675	2.355	0.770	8-2/0
3876	2½	3.516	2.222	1.310	2.408	0.940	14-4
3886	2½	3.516	2.222	1.675	2.598	0.940	8-2/0
3993	2½	3.516	2.222	2.230	2.928	0.940	6-4/0
3877-TB	3	4.234	2.761	1.310	2.767	0.975	14-4
3887-TB	3	4.234	2.761	1.675	2.957	0.975	8-2/0
3994	3	4.234	2.761	2.230	3.287	0.975	6-4/0
3878	3½	4.781	3.193	1.310	3.040	0.975	14-4
3863	3½	4.781	3.193	1.675	3.230	0.975	8-2/0
3995	3½	4.781	3.193	2.230	3.560	0.975	6-4/0
3879	4	5.328	3.623	1.310	3.314	0.980	14-4
3864	4	5.328	3.623	1.675	3.504	0.980	8-2/0
3996	4	5.328	3.623	2.230	3.834	0.980	6-4/0
3880	5	6.328	4.542	1.310	3.814	0.985	14-4
3865	5	6.328	4.542	1.675	4.000	0.985	8-2/0
3998	5	6.328	4.542	2.230	4.334	0.985	6-4/0
3881	6	7.406	5.458	1.310	4.353	1.200	14-4
3866	6	7.406	5.458	1.675	4.543	1.200	8-2/0
3999	6	7.406	5.458	2.230	4.875	1.200	6-4/0

Temperature rating 150 °C

\*Contact your regional sales office for copper lay-in lug

## Rigid and intermediate metal conduit fittings

### Bushings



**Nylon insulated metallic bushings.**  
**Steel or malleable iron (steel through 1½ in.)**  
 The Canadian Electric Code 10-906 (2) calls for protection of ungrounded conductors by means of smoothly rounded insulating surfaces at the entrance to raceways, pull boxes, junction boxes,

etc. T&B insulated throat fittings, recognizable by the distinctive trademarked blue insulating liner in the throat, meet and surpass this code requirement. In addition, T&B insulated fittings also reduce wire pulling effort by as much as 50%. Temperature rating 105 °C.

#### Insulated throat fittings



Diagram	Cat. no.		Dimensions (in.)		
	Steel or M.I.	Aluminum	Size (in.)	A	B
	1222	1222AL	½	1 1/32	29/64
	1223	1223AL	¾	1 9/32	31/64
	1224	1224AL	1	1 19/32	19/32
	1225-TB	1225AL	1 ¼	1 15/16	21/32
	1226-TB	1226AL	1 ½	2 3/16	23/32
	1227-TB	1227AL	2	2 11/16	7/8
	1228-TB	1228AL	2 ½	3 3/16	31/32
	1229-TB	1229AL	3	3 27/32	15/16
	1230	1230AL	3 ½	4 7/16	1 1/16
	1231	1231AL	4	4 7/8	1 3/32
	1232†	1232AL†	4 ½	5 7/16	1 15/64
	586	586AL	5	5 31/32	1 9/32
	587	587AL	6	7 3/16	1 11/32

† Not CSA Certified  
 The aluminum series are not CSA certified



**Aluminum, steel or malleable iron (steel through 1½ in.)**  
 Smoothly rounded shoulder covers end of conduit; broad flange covers knockout hole. High ribs make tightening easy with fingers or with wrench.

½ in.–1½ in. sizes, formed in steel, have extra smooth shoulders. Locknut-type base gives improved bonding and resists loosening under conditions of vibration.

#### Metallic bushings



Diagram	Cat. no.		Dimensions (in.)		
	Steel or M.I.	Aluminum	Size (in.)	A	B
	122	122AL	½	1 1/32	13/32
	123-TB	123AL*	¾	1 9/32	13/32
	124	124AL	1	1 19/32	½
	125-TB	125AL	1 ¼	1 15/16	9/16
	126	126AL	1 ½	2 3/16	9/16
	127	127AL	2	2 11/16	13/32
	128	128AL	2 ½	3 3/16	13/16
	129	129AL	3	3 27/32	13/16
	130-TB	130AL	3 ½	4 7/16	15/16
	131-TB	131AL	4	4 7/8	1
	132-TB	-	4 ½	5 7/16	1 5/64
	133-TB	133AL	5	6 1/16	1 1/16
	134-TB	134AL	6	7 3/16	1 1/16

\* Not UL Listed or CSA Certified



## Rigid and intermediate metal conduit fittings

### Plastic insulating bushings



#### All-plastic insulating bushings

Impact-resistant plastic insulation. These bushings have ribs for gripping when installing. Perfect threads for easy thread on. UL Listed 105 °C. NPT threaded.

#### Plastic insulating bushings



Diagram	Cat. no.	Size (in.)	Dimensions (in.)	
			A	B
	222-TB	$\frac{1}{2}$	$1\frac{1}{16}$	$\frac{3}{8}$
	223-TB	$\frac{3}{4}$	$1\frac{9}{32}$	$\frac{13}{32}$
	224	1	$1\frac{37}{64}$	$\frac{9}{16}$
	225-TB	$1\frac{1}{4}$	$2\frac{1}{32}$	$\frac{9}{16}$
	226	$1\frac{1}{2}$	$2\frac{15}{64}$	$\frac{9}{16}$
	227	2	$2\frac{25}{32}$	$\frac{5}{8}$
	228-TB	$2\frac{1}{2}$	$3\frac{13}{32}$	$\frac{3}{4}$
	229-TB	3	$4\frac{3}{32}$	$\frac{3}{4}$
	230-TB	$3\frac{1}{2}$	$4\frac{5}{8}$	$\frac{7}{8}$
	231	4	$5\frac{3}{16}$	$\frac{7}{8}$
	232	$4\frac{1}{2}$	$5\frac{5}{8}$	$\frac{7}{8}$
	233	5	$6\frac{3}{8}$	1
	234	6	$7\frac{1}{16}$	1

Flame retardant. UL rated 94V-1

## Rigid and intermediate metal conduit fittings

Insulating bushings for threadless rigid conduit and intermediate metal conduit



TRIB50 Series

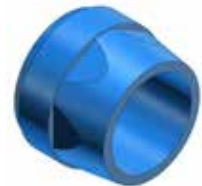

### Application

- When assembled to the end of a threadless conduit, provides a well-rounded insulating surface over which conductors may be pulled or on which conductors may bear while in service

### Features

- Designed to be popped onto, and bush, conduit end
- Fast easy installation without screws
- High impact thermoplastic construction

### Standard material

- High impact thermoplastic listed for 105 °C (221 °F) application
- Flammability classification 94V-1

### Standard finish

- As molded

### Range

- ½ in.–4 in. conduit

### Conformity

- UL 514B
- ANSI C80.4
- NFPA 70-2008 (ANSI)



1. Cut conduit end squarely. Remove sharp edges and burrs on inside and outside diameters by reaming or filing.
2. Slip the pop-on bushing over the end of the conduit.

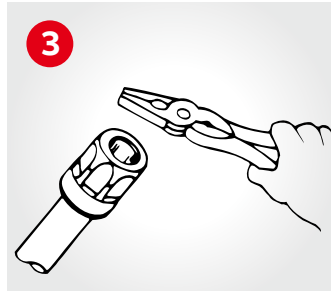

3. Using the flat surface of any standard utility tool such as an electricians pliers (or a hammer with a block of wood, for the larger sizes), strike the bushing on its top surface using a series of light blows until the end of the conduit rests against the bushing throat and conduit stop.

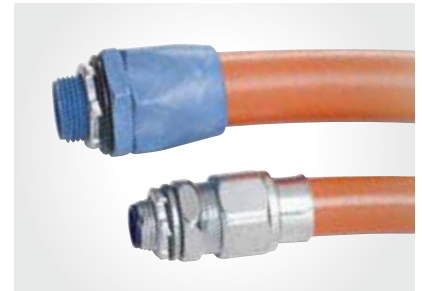

### Insulated metallic bushing



Diagram	Cat. no.	Size (in.)	Dimensions (in.)		
			A	B	C
	TRIB-50	½	19/32	19/32	1 1/16
	TRIB-75	¾	25/32	1 25/64	1 ¼
	TRIB-100	1	1	1 ½	1 9/16
	TRIB-125	1 ¼	1 5/16	1 5/8	1 59/64
	TRIB-150	1 ½	1 17/32	1 21/32	2 11/64
	TRIB-200	2	1 31/32	1 13/16	2 11/16
	TRIB-250	2 ½	2 23/64	2	3 ¼
	TRIB-300	3	2 59/64	2 7/32	3 29/32
	TRIB-350	3 ½	3 3/8	2 5/16	4 29/64
	TRIB-400	4	3 27/32	2 13/32	5

IMC sizes ½ in.–4 in.

UL Rated flame retardant 94V-1

## Rigid and intermediate metal conduit fittings

### Knockout bushings



3210 Series

#### Application

- To bush knockout openings in metal boxes or enclosures

#### Features

- One-piece construction designed to snap in place
- High impact strength self-extinguishing, non-dripping (per UL 94) thermoplastic construction

#### Standard material

- Thermoplastic rated for 105 °C (221 °F) application

#### Standard finish

- As molded

#### Range

- 0.875 in. through 2.469 in. nominal diameter knockout opening ( $\frac{1}{2}$  in. through 2 in. trade size knockouts)
- Wall thickness of box or enclosure 0.095 in. max. up to 1 in. trade size, 0.140 in. max.  $1\frac{1}{4}$  in. through 2 in. trade size

#### Conformity

- UL 514B
- CSA C22.2 No. 18.3
- NFPA 70-2008 (ANSI)

One-piece knockout bushing quickly snaps into outlet box, switch box or other enclosure left vacant by wiring modifications or maintenance changes. Provides smooth, rounded insulation surface for easy wire pulling. Easily installed by hand, they are available to fit  $\frac{1}{2}$  in. through 2 in. knockouts. UL Listed 105 °C. High impact thermoplastic.

#### Knockout bushings



Diagram	Cat. no.	Trade size (in.)	For use in KO* +0.032/ -0.16 (in.)	Max. wall thickness of elec. box (in.)	Dimensions (in.)			
					A	B	C	D
	3210	$\frac{1}{2}$	0.875	0.095	1.000	0.725	0.360	0.180
	3211	$\frac{3}{4}$	1.109	0.095	1.215	0.940	0.360	0.180
	3212	1	1.375	0.095	1.500	1.200	0.360	0.180
	3213	$1\frac{1}{4}$	1.734	0.140	1.865	1.550	0.400	0.210
	3214	$1\frac{1}{2}$	1.984	0.140	2.240	1.760	0.530	0.310
	3215	2	2.469	0.140	2.740	2.245	0.530	0.310

\* Per UL and NEMA standards  
 Material: Thermoplastic  
 Flammability classification of 94V-1 Per UL 94  
 Service temperature: -40 °C to 105 °C

## Rigid and intermediate metal conduit fittings

### INSULINER® sleeves



**Slip over wires – insert into bushing – snaps into place.**

High dielectric nylon, 105 °C. An INSULINER sleeve snapped into a regular bushing makes a CSA Listed insulated bushing. For standard rigid conduit, EMT

(thinwall conduit) or any standard bushed outlet. Especially suitable for use with flexible metallic conduit. Converts ordinary bushing to code-approved insulated bushing without disturbing wiring.

#### INSULINER sleeves



	Cat. no.	Size (in.)	Dimensions (in.)	
			A	B
	422	½	⅝	0.022
	423	¾	11/16	0.025
	424	1	7/8	0.040
	425	1¼	1	0.040
	426-TB	1½	1	0.050
	427-TB	2	1⅞	0.050
	428-TB	2½	1¼	0.035
	429	3	1½	0.035
	430-TB	3½	1 <sup>25</sup> / <sub>32</sub>	0.035
	431	4	2 <sup>1</sup> / <sub>32</sub>	0.035
	433	5	2½	0.035
	434	6	2½	0.035

Oxygen index >28\*

## Rigid and intermediate metal conduit fittings

### Knockout plugs

#### Application

- To bush knockout openings in metal boxes or enclosures

#### Features

- One-piece construction designed to snap in place
- High impact strength self extinguishing non-dripping (per UL 94) thermoplastic construction

#### Standard material

- Thermoplastic rated for 105 °C (221 °F) application

#### Standard finish

- As molded

#### Range

- 0.875 in. through 2.469 in. nominal diameter knockout opening (½ in. through 2 in. trade size knockouts)
- Wall thickness of box or enclosure:
  - 0.095 in. max. up to 1 in. trade size
  - 0.140 in. max. 1¼ in. through 2 in. trade sizes

#### Conformity

- UL 514B
- CSA C22.2 No. 18.3
- NFPA 70-2008 (ANSI)

105 °C rated by UL. Made from flame-retardant, non-dripping thermoplastic.



	Cat. no.	Knockout trade size (in.)	Dimensions (in.)	
			A	B
	1451	½	1.060	0.400
	1452	¾	1.300	0.400
	1453	1	1.590	0.400
	1454	1¼	1.860	0.450
	1455	1½	2.240	0.570
	1456	2	2.740	0.570

Wall thickness of electrical box 0.095 max.

A penny under a bushing will seal the end of the conduit during construction. Made to fit any bushing. Completely salvageable.



#### Pennies – Steel



Cat. no.	Size (in.)
815-TB	½
816	¾
817	1
818	1¼
819	1½
820	2
821	2½
822	3
824-TB	3½
823	4

UL not applicable

## Rigid and intermediate metal conduit fittings

### Bushings and Push-Penny® plugs

#### Application

- To plug open end of conduit or fitting in order to prevent ingress of trash, dirt or moisture during construction and remodeling

#### Features

- Wide range of applications; can be used with rigid metal conduit, intermediate metal conduit, electrical metallic tubing, all connectors and all bushings
- Designed to stand up to normal handling and is functionally unaffected by moisture

#### Standard material

- Polyethylene

#### Standard finish

- As molded

#### Conformity

- CSA C22.2 No. 18
- ANSI C80.4
- NFPA 70-2008 (ANSI)
- NEMA FB-1

#### CEC Rule: 12-3024

- “Unused openings in boxes, cabinets and fittings shall be effectively closed by plugs or plates affording protection substantially equivalent to that of the wall of the box, cabinet or fittings.”

#### Bushings and Push-Penny plugs



	Cat. no.	Size (in.)	A (in.)	Assembly consist of	
				Bushing	Push-Penny
	1460	½	1⅜	122	1470-TB
	1461	¾	1⅝	123-TB	1471
	1462	1	1⅞	124	1472
	1463	1¼	1⅝ <sub>16</sub>	125	1473
	1464	1½	2⅞ <sub>16</sub>	126	1474
	1465*	2	2⅞ <sub>32</sub>	127	1475

\* Malleable Iron  
Available in aluminum  
Add suffix AL to cat. no.

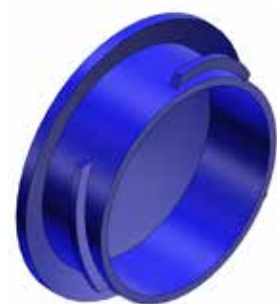

#### Push-Penny plugs



Cat. no.	Size (in.)
1470-TB	½
1471	¾
1472	1
1473	1¼
1474	1½
1475	2
1476*	2½
1477*	3
1478*	3½
1479*	4

\*Not CSA Certified  
UL not applicable

# Rigid and intermediate metal conduit fittings

## Chase nipples

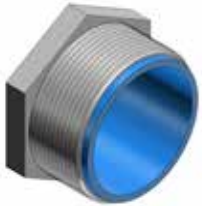

1942 series  
842AL series  
(non-insulated)

### Application

- To effectively bush factory or field-punched, cut, or drilled holes in metal boxes or enclosures
- To couple boxes back-to-back

### Features

- Rugged construction
- Insulator curled over to: Bush conductors entering/leaving at any angle, reduce wire pull effort, protect threads against damage in handling

### Standard material

#### 1942 Series

- Body:
  - ½ in. – Steel
  - ¾ in., ¾ in. through 6 in. – Malleable iron
- Insulator: Nylon
- 842AL Series: All copper-free aluminum (less than 0.4% copper)

### Standard finish

- 1942 Series: Electro-zinc plated and chromate coated
- 842AL Series: Degreased

### Range 1942 and 842AL series

- ½ in. through 6 in.
- All hub threads straight pipe (NPS)

### Conformity

- UL 514B
- CSA C22.2 No. 18.3
- Federal Specification W-F-408
- ANSI C80.4
- NFPA 70-2008 (ANSI)
- NEMA FB-1
- Federal Standard H-28 (threads)

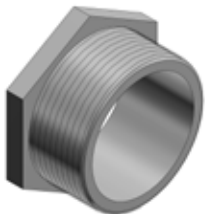

Steel, malleable iron or aluminum

### CHASE nipples – Non-insulated

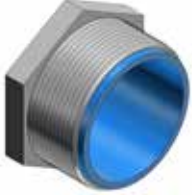

Diagram	Cat. no.		Dimensions (in.)		
	Stl. or M.I.	Alum.	Size (in.)	A	B
	841TB	–	3/8	13/16	7/16
	842TB	842ALTB†	1/2	15/16	11/32
	843TB	843ALTB	3/4	1 3/16	11/32
	844	844AL†	1	1 7/16	2 1/32
	845	845AL†	1 1/4	1 3/4	3/4
	846	846AL	1 1/2	2 1/16	13/16
	847	847AL	2	2 1/2	3 1/32
	848	848AL	2 1/2	3 1/16	1 1/16
	849	849AL	3	3 13/16	1 3/16
	850	850AL	3 1/2	4 3/8	1 5/16
	851	851AL	4	4 3/4	1 5/16
	853	853AL	5	5 7/8	1 5/16
	854	854AL	6	6 15/16	1 7/8

† Not UL Listed

## Rigid and intermediate metal conduit fittings

### CHASE nipples



—  
Steel or malleable iron

—  
CHASE nipples – Nylon insulated



Diagram	Cat. no.	Size (in.)	Dimensions (in.)		
			A	B	C
	1942	$\frac{1}{2}$	$\frac{15}{16}$	$\frac{1}{2}$	$\frac{19}{32}$
	1943	$\frac{3}{4}$	$1\frac{3}{16}$	$\frac{17}{32}$	$\frac{23}{32}$
	1944	1	$1\frac{7}{16}$	$\frac{21}{32}$	$\frac{7}{8}$
	1945-TB	$1\frac{1}{4}$	$1\frac{3}{4}$	$\frac{25}{32}$	$1\frac{1}{32}$
	1946	$1\frac{1}{2}$	$2\frac{1}{16}$	$\frac{13}{16}$	$1\frac{3}{32}$
	1947	2	$2\frac{9}{16}$	$\frac{31}{32}$	$1\frac{11}{32}$
	1948	$2\frac{1}{2}$	$3\frac{1}{16}$	$1\frac{1}{16}$	$1\frac{7}{16}$
	1949	3	$3\frac{13}{16}$	$1\frac{3}{16}$	$1\frac{19}{32}$
	1950	$3\frac{1}{2}$	$4\frac{3}{8}$	$1\frac{5}{16}$	$1\frac{25}{32}$
	1951	4	$4\frac{7}{8}$	$1\frac{5}{16}$	$1\frac{13}{16}$
	1953	5	$5\frac{29}{32}$	$1\frac{5}{16}$	$1\frac{13}{16}$
	1954	6	$6\frac{13}{16}$	$1\frac{3}{8}$	$1\frac{7}{8}$



## Rigid and intermediate metal conduit fittings

Threaded hubs (Bullet® hubs) for threaded rigid metal conduit/IMC/PVC-coated rigid metal conduit

—  
01 370 Series  
370AL Series  
—  
02 485 Series

### Application

- To connect threaded metal conduit (ferrous rigid/nonferrous rigid/PVC-coated/or intermediate metal) to a threadless opening in a box or enclosure in outdoor or indoor location exposed to continuous or intermittent moisture
- To positively bond conduit to box or enclosure

### Features

- Rugged steel/malleable iron/copper-free aluminum construction
- Tapered internal threads for watertight/dust-tight union (A)
- Threads relieved to prevent bottoming of conduit, ensuring sound assembly (B)
- Recessed sealing ring at box end; captive sealing ring (C)
- Hardened steel/malleable iron/copper-free aluminum locknuts designed to provide high quality ground continuity; extended reach of locknut permits clamping on thin boxes and enclosures (D)
- Insulated throat protects conductors, prevents abrasion and thinning of conductor insulation, reduces wire pull effort (E)
- Suitable for hazardous location use per following:
  - (1) Class II, Division 1 Groups E, F, G, CEC Rule 18-202
  - Class II, Division 2 Groups E, F, G, CEC Rule 18-252
  - Class III, Division 1 Rule 18-302
  - Class III, Division 2 Rule 18-352

### • PVC-coated 485 series

- (1) Protects fitting from extremely corrosive surroundings without affecting integrity of electrical grounding path (F)
- (2) Provided with overlapping sleeve for additional seal (G)

Canadian Electric Code Rule 10-602 states that, “Where dissimilar metals cannot be avoided at bonding connections as indicated in Rule 2-112 (2). Connections shall be made using methods or material that will minimize deterioration from galvanic action.”

Joint Industrial Council (JIC) Electrical Standards also forbid dissimilar metals in contact for the same reason and require that the fittings for metal conduit be of malleable iron or ductile iron and have impact strength comparable to that of the conduit.

### “Copper-free aluminum”

- Copper-free aluminum castings for fittings have a maximum of 0.4% copper. The most detrimental effect of higher percentage of copper on aluminum base alloy is its decrease in corrosion resistance.

### Diagrams

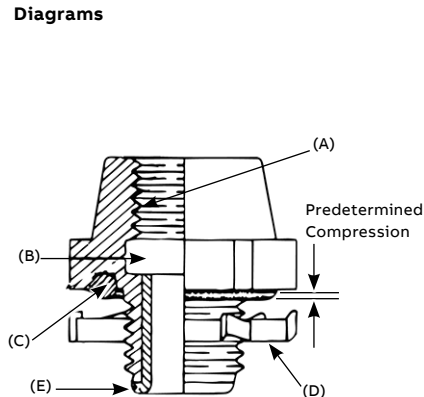

—  
01

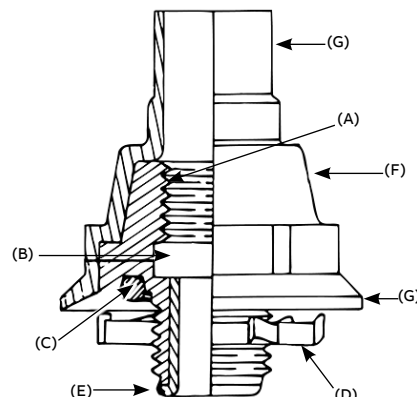

—  
02

## Rigid and intermediate metal conduit fittings

Threaded hubs (Bullet® hubs) for threaded rigid metal conduit/IMC/PVC-coated rigid metal conduit

### Standard material

	370-485 Series	370AL Series
Body	½ in. through 1 in. steel 1¼ in. through 6 in. malleable iron	All copper-free aluminum
Locknut	½ in. through 2 in. steel (hardened) 2½ in. through 6 in. malleable iron	½ in. through 2 in. steel (hardened) 2-½ in. through 4 in. copper-free aluminum
Screws	Steel (hardened)	
O-ring	Buna N	
Insulator	Nylon	
Coating	PVC	

### Standard finish

	370 Series	370AL Series	485 Series
Hub	Electro-zinc plated	As cast chromate coated	PVC – outside electro-zinc
Locknuts	All ferrous locknuts electro-zinc plated and chromate coated		Plated chromate coated – inside
Screws	All electro-zinc plated and chromate coated		

### Range

370 Series	½ in. through 6 in. conduit
370AL and 485 Series	½ in. through 4 in. conduit All hub threads – straight pipe All female threads – taper pipe (NPT)

### Conformity

UL 514B  
CSA 22.2 No. 18.3  
ANSI C80.4  
NFPA 70-2008 (ANSI)  
NEMA FB-1  
JIC EGP1; JIC EMP 1  
Federal Specification W-F-408  
Federal Standard H-28 (threads)

## Rigid and intermediate metal conduit fittings

### Hubs



#### Nylon insulated

Aluminum, steel or malleable iron (steel through 1 in.). With neoprene O-ring provides a watertight threaded hub on enclosures. UL Listed 105 °C.

#### Steel/malleable iron and aluminum hub fittings†



Diagram	Cat. no.		Size (in.)	Dimensions (in.)			Wall thk. max. (in.)
	Stl. or M.I.	Alum.**		A	B	C	
	370	370AL	½	1⅜	1⅝	¾	⅝
	371	371AL	¾	1⅝	1⅞	⅞	⅝
	372	372AL	1	2⅜	1 <sup>23</sup> / <sub>32</sub>	1 <sup>7</sup> / <sub>32</sub>	⅝
	373	373AL	1¼	2 <sup>9</sup> / <sub>16</sub>	2	1 <sup>11</sup> / <sub>32</sub>	⅝
	374	374AL	1½	3 <sup>3</sup> / <sub>32</sub>	2	1 <sup>11</sup> / <sub>32</sub>	⅝
	375	375AL	2	3 <sup>5</sup> / <sub>8</sub>	1 <sup>31</sup> / <sub>32</sub>	1 <sup>11</sup> / <sub>32</sub>	⅝
	376	—	2½	4⅞	2 <sup>21</sup> / <sub>32</sub>	1 <sup>15</sup> / <sub>16</sub>	⅝
	377	—	3	5	2 <sup>31</sup> / <sub>32</sub>	2	½
	378	—	3½	5 <sup>9</sup> / <sub>16</sub>	3⅞	2⅞	½
	379-TB	—	4	6 <sup>9</sup> / <sub>16</sub>	3⅞	2⅞	½
	381-TB	—	5	8	4	2 <sup>3</sup> / <sub>16</sub>	½
	382-TB	—	6	9 <sup>3</sup> / <sub>16</sub>	4	2 <sup>3</sup> / <sub>16</sub>	½

\*\* Aluminum not available with insulated throat

† UL Listed raintight and CSA Certified watertight and dust tight



#### Bullet hub fittings with bonding locknut – Nylon insulated



Cat. no.	Size (in.)	Description
401	½	Available in steel or malleable iron Supplied with 106 Series bonding nut. Temperature rating: 105 °C.
402	¾	
403-TB	1	
407	2½	
408	3	
409	3½	
410-TB	4	

CSA certified watertight and dust tight

# Rigid and intermediate metal conduit fittings

## Hubs



Steel or malleable iron (steel through 1 1/4 in.)

PVC-coated hub for rigid conduit



Diagram	Cat. no.	Size (in.)	Dimensions (in.)		
			A	B	C
	485	1/2	1 21/64	2 1/8	1 7/8
	486	3/4	1 19/32	2 3/8	2 1/8
	487	1	1 27/32	2 3/4	2 3/8
	488	1 1/4	2 15/32	3 3/8	3 1/8
	489	1 1/2	2 29/32	3 5/8	3 1/2
	490	2	3 3/8	3 3/4	4
	491	2 1/2	3 27/32	4	4 1/2
	492	3	4 21/32	4 5/8	5 3/8
	493	3 1/2	5 9/64	4 13/16	5 7/8
	494	4	5 3/4	4 9/16	6 7/16

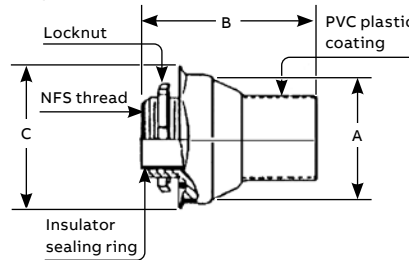

\*485 Series are CSA Certified watertight and dust-tight for ordinary locations

### Spacing chart for Bullet hubs



Center to center spacing conduit sizes (in.)											Min. space from center of Bullet hub to wall of box (in.)	KO diameter min. (in.)	
	1/2	3/4	1	1 1/4	1 1/2	2	2 1/2	3	3 1/2	4			
1/2	1 1/16	1 5/8	1 3/4	2 1/8	2 3/8	2 5/8	2 7/8	3 5/16	3 1/2	3 3/8	3 7/8	3/4	7/8
3/4	-	1 3/4	1 7/8	2 1/4	2 1/2	2 3/4	3	3 1/2	3 3/4	4 1/8	4 1/4	7/8	1 1/8
1	-	-	2	2 3/8	2 5/8	2 7/8	3 1/8	3 5/8	3 7/8	4 1/4	4 1/2	1 1/8	1 3/8
1 1/4	-	-	-	2 11/16	2 15/16	3 1/4	3 1/2	4	4 1/4	4 1/2	4 3/4	1 3/8	1 3/4
1 1/2	-	-	-	-	3 1/8	3 1/2	3 3/4	4 1/8	4 3/8	4 3/4	4 3/4	1 5/8	2
2	-	-	-	-	-	3 3/4	4	4 1/2	4 3/4	5	5	1 7/8	2 1/2
2 1/2	-	-	-	-	-	-	4 1/4	4 3/4	5	5 3/8	5 3/8	2 1/8	3
3	-	-	-	-	-	-	-	5 1/8	5 3/8	5 3/4	5 3/4	2 5/8	3 3/8
3 1/2	-	-	-	-	-	-	-	-	5 5/8	6	6	2 7/8	4 1/8
4	-	-	-	-	-	-	-	-	-	6 1/4	6 1/4	3 1/4	4 5/8

### T&B Hub centerline spacing chart



Conduit trade size (in.)	1/2 (in.)	3/4 (in.)	1 (in.)	1 1/4 (in.)	1 1/2 (in.)	2 (in.)	2 1/2 (in.)	3 (in.)	3 1/2 (in.)	4 (in.)	5 (in.)	6 (in.)
1/2	1 9/16	-	-	-	-	-	-	-	-	-	-	-
3/4	1 43/64	1 25/32	-	-	-	-	-	-	-	-	-	-
1	1 27/32	1 61/64	2 1/8	-	-	-	-	-	-	-	-	-
1 1/4	2 1/32	2 9/64	2 5/16	2 1/2	-	-	-	-	-	-	-	-
1 1/2	2 7/32	2 21/64	2 1/2	2 11/16	2 7/8	-	-	-	-	-	-	-
2	2 15/32	2 37/64	2 3/4	2 19/16	3 3/8	3 3/8	-	-	-	-	-	-
2 1/2	2 23/32	2 53/64	3	3 3/16	3 3/8	3 3/8	3 3/8	-	-	-	-	-
3	3 1/32	3 9/64	3 5/16	3 1/2	3 11/16	3 15/16	4 3/16	4 1/2	-	-	-	-
3 1/2	3 11/32	3 21/64	3 5/8	3 13/16	4	4 1/4	4 1/2	4 13/16	5 1/8	-	-	-
4	3 19/32	3 45/64	3 7/8	4 1/16	4 1/4	4 1/2	4 3/4	5 1/16	5 3/8	5 5/8	-	-
5	4 3/32	3 25/64	4 9/16	4 3/4	4 15/16	5 1/16	5 7/16	5 3/4	6 1/16	6 3/16	7	-
6	4 11/16	4 51/64	4 31/32	5 5/32	5 11/32	5 19/32	5 27/32	6 5/32	6 15/32	6 23/32	7 13/32	7 13/16
<b>Nearest obstruction to center of hub</b>												
	27/32	61/64	1 1/8	1 1/16	1 1/2	1 3/4	2	2 5/16	2 5/8	2 7/8	2 9/16	3 31/32

# Rigid and intermediate metal conduit fittings

## Hubs

1. Sealing ring and groove with innovative profile outperforms standard O-ring design. Sealing ring is captive before installation and resists buckling or slipping during installation. The seal groove is designed for optimum compression of the sealing ring. The sealing ring is designed to provide a complete 360° seal, even when the conduit is not perpendicular with the enclosure. (See Figure 1)

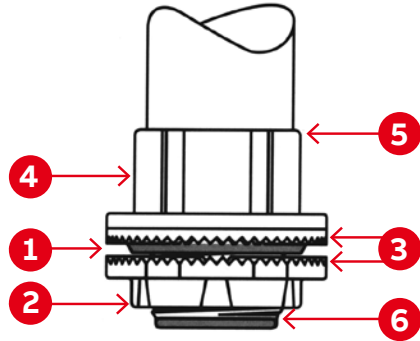

Never before has a single hub fit like this one. Designed for unequalled performance. The innovative engineering of the hub will, quite simply, raise your performance expectations for threaded hubs. The revolution in hub design is here, and the fate of our competition is sealed.

2. Locknut design with peripheral slots and a hexagonal/angled spline spaced every 30° enables easy application of torque with wrench or hammer and screwdriver. (See Figures 2 & 3)

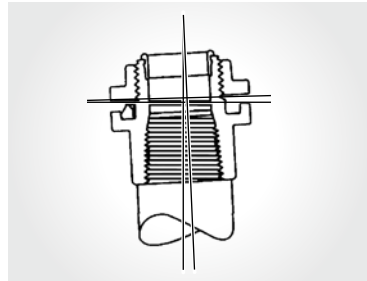

01

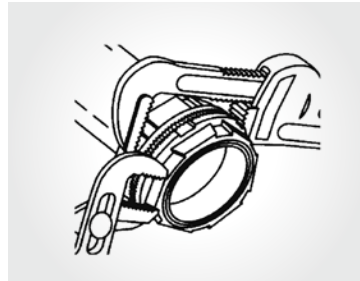

02

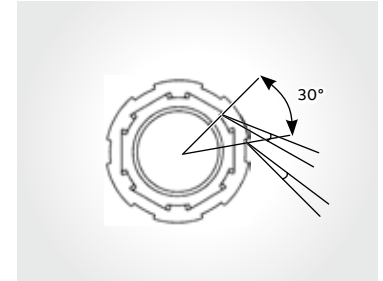

03

3. Sharper and deeper teeth on locknut and body designed for a more penetrating bite for improved bonding to the enclosure.

4. Hexagonal / splined body design for fast, easy installation with wrench or hammer and screwdriver.



5. Precision machined tapered threads designed to create watertight union.

The T&B Hub



6. Insulated throat molded from 105 °C rated thermoplastic with a flammability rating of 94V-0.

01 Figure 1

02 Figure 2

03 Figure 3

Diagram

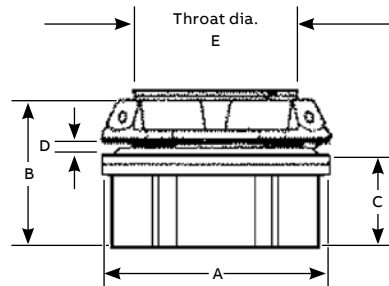

Cat. no. zinc	Cat. no. aluminum	Trade size (in.)	Dimensions (in.)			Max. panel thickness D (in.)	Throat dia. E (in.)
			A	B	C		
H050-TB	H050A	½	1 7/16	1 9/16	7/8	3/16	1 9/32
H075-TB	H075A	¾	1 21/32	1 19/32	2 9/32	3/16	2 5/32
H100-TB	H100A	1	2	1 13/16	1 1/16	¼	1
H125-TB	H125A	1 ¼	2 3/8	1 7/8	1 1/16	¼	1 5/16
H150-TB	H150A	1 ½	2 ¾	1 7/8	1 1/16	¼	1 17/32
H200-TB	H200A	2	3 ¼	1 15/16	1 5/32	¼	1 31/32
H250-TB	H250A	2 ½	3 ¾	2 9/16	1 9/16	¼	2 13/32
H300-TB	H300A	3	4 3/8	2 23/32	1 19/32	¼	2 31/32
H350-TB	H350A	3 ½	5	2 23/32	1 7/8	¼	3 13/32
H400-TB	H400A	4	5 ½	2 23/32	1 7/8	¼	3 7/8
H500-TB	H500A	5	6 7/8	3 1/32	1 15/16	¼	4 15/16
H600-TB	H600A	6	7 11/16	3 5/32	2	¼	6

Material – Hub and locknut: Zinc or copper-free aluminum  
 Insulating throat: Thermoplastic temp. rating 105 °C, flammability rating: 94V-0  
 Sealing ring: Nitrile (Buna N)

For chrome-plated hubs add suffix **CP** (i.e. H050CP).  
 Meets NEMA sealing requirements for NEMA 3R, 4 and 13 enclosures.  
 UL Listed and CSA Certified. CSA Certified use in hazardous locations Class I, Division 2, Class II, Groups E, F and G, Class III, Division 1, 2 and Type 4.  
 Chrome-plated hubs (suffix-**CP**) are rated NEMA 4X.  
 For aluminum hubs add suffix **A** (i.e. H050A).

# Rigid and intermediate metal conduit fittings

## Hubs



Grounding hub



Diagram	Cat. no. zinc	Cat. no. aluminum	Trade size (in.)	Dimensions (in.)				
				Dia. (in.)			D Max. Panel Thickness	E Throat dia.
				A	B	C		
	H050GR-C	H050GRA-C	1/2	1 1/16	1 9/16	7/8	3/16	1 9/32
	H075GR-C	H075GRA-C	3/4	1 7/16	1 19/32	2 9/32	3/16	2 5/32
	H100GR-C	H100GRA-C	1	2	1 13/16	1 1/16	1/4	1
	H125GR-C	H125GRA-C	1 1/4	2 3/8	1 7/8	1 1/16	1/4	1 1/16
	H150GR-C	H150GRA-C	1 1/2	2 3/4	1 7/8	1 1/16	1/4	1 17/32
	H200GR-C	H200GRA-C	2	3 1/4	1 15/16	1 15/32	1/4	1 31/32
	H250GR-C	H250GRA-C	2 1/2	3 3/4	2 9/16	1 9/16	1/4	2 13/32
	H300GR-C	H300GRA-C	3	4 3/8	2 21/32	1 19/32	1/4	2 31/32
	H350GR-C	H350GRA-C	3 1/2	5	2 23/32	1 5/8	1/4	3 13/32
	H400GR-C	H400GRA-C	4	5 1/2	2 23/32	1 5/8	1/4	3 7/8
	H500GR-C	H500GRA-C	5	6 7/8	3 1/32	1 15/16	1/4	4 15/16
	H600GR-C	H600GRA-C	6	7 15/16	3 5/32	2	5/16	6

Material—Hub and locknut: Zinc or copper-free aluminum  
 Insulating throat: Thermoplastic temp. rating 105 °C;  
 flammability rating: 94V-0  
 Sealing ring: Nitrile (Buna N)

For chrome-plated hubs add suffix CP (i.e. H050GRCP)  
 For 316 stainless steel hubs add suffix SST (i.e. H050GRSST)  
 For PVC coating add suffix PVC (i.e. H050GRPVC-C)  
 Meets NEMA sealing requirements for NEMA 3R, 4 & 13 enclosures  
 UL Listed and CSA Certified  
 CSA approved for use in hazardous locations: Class I, Division 2, Class II, Divisions 1 & 2, Groups E, F & G, Class III, Division 1, 2 and Type 4.



Grounding and bonding locknut



Diagram	Cat. no. with lay-in lug	Cat. no. without lay-in lug	Trade size (in.)	A dia. (in.)	B height (in.)	Ground screw (in.)	Max.
							conductor size (AWG)
	L050GRL	L050GR-C	1/2	1 1/2	1 3/32	#10-32 x 1/4	#10
	L075GRL	L075GR-C	3/4	1 11/16	1 3/32	#10-32 x 1/4	#10
	L100GRL	L100GR-C	1	2	1 3/32	#10-32 x 1/4	#10
	L125GRL	L125GR-C	1 1/4	2 3/8	1 5/32	1/4-20 x 1/4	#10
	L150GRL	L150GR-C	1 1/2	2 3/4	1 5/32	1/4-20 x 5/16	#8
	L200GRL	L200GR-C	2	3 3/4	1 5/32	1/4-20 x 5/16	#8
	L250GRL	L250GR-C	2 1/2	3 3/4	1 1/16	1/4-20 x 5/16	#6
	L300GRL	L300GR-C	3	4 3/8	2 3/32	1/4-20 x 5/16	#6
	L350GRL	L350GR-C	3 1/2	5	2 3/32	1/4-20 x 5/16	#6
	L400GRL	L400GR-C	4	5 1/2	2 3/32	1/4-20 x 5/16	#4

Material — Locknut: zinc or copper-free aluminum  
 For aluminum locknuts add suffix A. (i.e. L050GRA-C)

For chrome-plated locknuts add suffix CP. (i.e. L050GR-CP)  
 For 316 stainless steel locknuts add suffix SST. (i.e. L050GRSST).

## Rigid and intermediate metal conduit fittings

### Bulkhead fittings

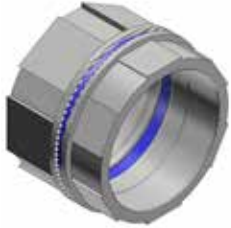

#### Bulkhead fittings



Diagram	Cat. no. zinc	Cat. no. aluminum	Trade size (in.)
	H050BHD	H050BHDA	½
	H075BHD	H075BHDA	¾
	H100BHD	H100BHDA	1
	H125BHD	H125BHDA	1¼
	H150BHD	H150BHDA	1½
	H200BHD	H200BHDA	2
	H250BHD	H250BHDA	2½
	H300BHD	H300BHDA	3
	H350BHD	H350BHDA	3½
	H400BHD	H400BHDA	4
	H500BHD	H500BHDA	5

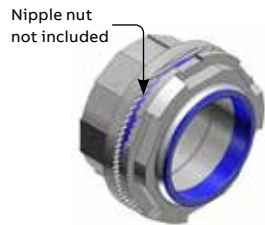

#### Thru-bulkhead fittings



Cat. no. zinc	Cat. no. aluminum	Size (in.)
H050TBF	H050TBFA	½
H075TBF	H075TBFA	¾
H100TBF	H100TBFA	1
H125TBF	H125TBFA	1¼
H150TBF	H150TBFA	1½
H200TBF	H200TBFA	2

# Rigid and intermediate metal conduit fittings

## Bulkhead fittings

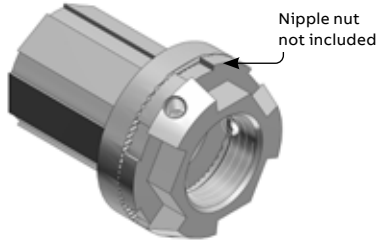

Thru-bulkhead hub



Cat. no. zinc	Cat. no. aluminum	Size (in.)
H050TBH	H050TBHA	½
H075TBH	H075TBHA	¾
H100TBH	H100TBHA	1
H125TBH	H125TBHA	1¼
H150TBH	H150TBHA	1½
H200TBH	H200TBHA	2

Diagrams	Trade size (in.)	Thread (in.)	Height (in.)	Diameter (in.)	Across Flats (in.)	A (in.)	B (in.)
	½	½-14	1 <sup>13</sup> / <sub>32</sub>	1 <sup>7</sup> / <sub>16</sub>	1	¾	½
	¾	¾-14	1 <sup>15</sup> / <sub>32</sub>	1 <sup>11</sup> / <sub>16</sub>	1¼	2 <sup>5</sup> / <sub>32</sub>	1 <sup>7</sup> / <sub>32</sub>
	1	1-11½	1 <sup>11</sup> / <sub>16</sub>	2	1 <sup>17</sup> / <sub>32</sub>	2 <sup>9</sup> / <sub>32</sub>	1 <sup>9</sup> / <sub>32</sub>
	¾	1¼-11½	1 <sup>25</sup> / <sub>32</sub>	2 <sup>3</sup> / <sub>8</sub>	1 <sup>27</sup> / <sub>32</sub>	2 <sup>9</sup> / <sub>32</sub>	2 <sup>1</sup> / <sub>32</sub>
	1½	1½-11½	1 <sup>13</sup> / <sub>16</sub>	2¾	1½	2 <sup>9</sup> / <sub>32</sub>	2 <sup>1</sup> / <sub>32</sub>
	2	2-1½	1 <sup>27</sup> / <sub>32</sub>	3¼	2 <sup>5</sup> / <sub>8</sub>	1 <sup>5</sup> / <sub>16</sub>	2 <sup>1</sup> / <sub>32</sub>
	2½	2½-8	2 <sup>9</sup> / <sub>32</sub>	3¾	3½	1 <sup>7</sup> / <sub>32</sub>	7/8
	3	3-8	2 <sup>9</sup> / <sub>16</sub>	4 <sup>3</sup> / <sub>8</sub>	3 <sup>25</sup> / <sub>32</sub>	1 <sup>5</sup> / <sub>16</sub>	2 <sup>9</sup> / <sub>32</sub>
	3½	3½-8	2 <sup>9</sup> / <sub>16</sub>	5	4 <sup>9</sup> / <sub>32</sub>	1 <sup>3</sup> / <sub>8</sub>	7/8
	4	4-8	2 <sup>9</sup> / <sub>16</sub>	5½	4 <sup>27</sup> / <sub>32</sub>	1 <sup>3</sup> / <sub>8</sub>	7/8
	5	5-8	2 <sup>23</sup> / <sub>32</sub>	6 <sup>5</sup> / <sub>8</sub>	5 <sup>29</sup> / <sub>32</sub>	1 <sup>15</sup> / <sub>32</sub>	7/8
	6	6-8	3	7 <sup>11</sup> / <sub>16</sub>	7½	1½	3 <sup>1</sup> / <sub>32</sub>

Diagrams	A (in.)	B (in.)

Material— Hub, body and locknut: Zinc or copper-free aluminum  
 Insulating throat: Thermoplastic temp. rating 105 °C; flammability rating: 94V-0  
 Sealing ring: Nitrile (Buna N)  
 For chrome-plated bulkhead add suffix CP



## Rigid and intermediate metal conduit fittings

### XD expansion/deflection couplings for rigid conduit



#### Watertight, flexible connections support movement and thermal expansion.

Use the XD expansion/deflection coupling to join two conduit runs in applications where movement in any direction is required. The coupling provides a flexible, watertight connection, accommodating axial or parallel movement of up to  $\frac{3}{4}$  in. and angular movement of up to  $30^\circ$  from normal position. While similar fittings exist on the market today, this XD expansion/deflection coupling ships complete with an Erickson® conduit union to significantly reduce installation time and effort and includes a stainless steel inner sleeve for extreme durability, protection and easier wire pulling.

The hubs are zinc-plated and then coated with aluminum acrylic paint for dual-layer corrosion protection. In addition, the copper ground mounting plates and internal grounding bonding jumper are entirely enclosed inside the coupling for added security against vandalism and theft.

- Accommodates axial expansion/contraction up to  $\frac{3}{4}$  in., parallel deflection up to  $\frac{3}{4}$  in. and angular misalignment up to  $30^\circ$

- Suitable for use indoors, outdoors, direct buried or embedded in concrete
- Watertight, flexible neoprene outer jacket, zinc-plated and acrylic-painted hubs and stainless steel tamper-proof straps ensure superior corrosion resistance – ideal for use in harsh environments
- Copper ground mounting plates and internal grounding bonding jumper both entirely enclosed to safeguard against theft
- Includes an Erickson conduit union for faster, easier installation to reduce labor costs
- Durable stainless steel inner sleeve provides a constant, smooth inner diameter in any position to ease wire pulling and protect wire insulation from damage
- NPT threaded hubs fit standard threaded rigid metal conduit
- Can also be used with rigid PVC conduit with the use of standard adapters (not supplied)

#### Standard material/finish

- Hub: Ductile cast iron, zinc-plated and aluminum acrylic painted
- Inner sleeve: Stainless steel
- Internal grounding bonding jumper: Flexible copper braid
- Ground mounting plates: Copper
- Hub rings: Zinc-plated steel
- Outer jacket: Molded neoprene (natural black)
- Jacket straps: Stainless steel

#### Certifications/compliances

- CSA Certified to C22.2 and UL Listed to UL 514B No. 18
- Suitable for wet locations (hub sizes 1 in.–2½ in.)
- Watertight
- NEC Article 250.98 compliant

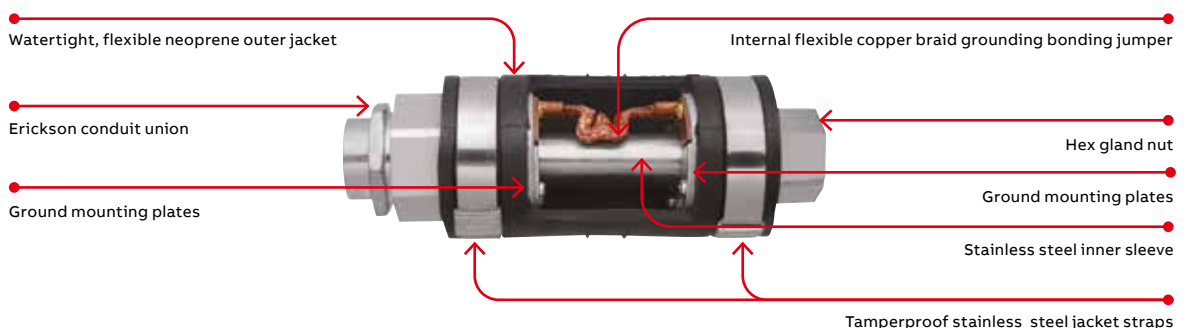

## Rigid and intermediate metal conduit fittings

XD expansion/deflection couplings for rigid conduit

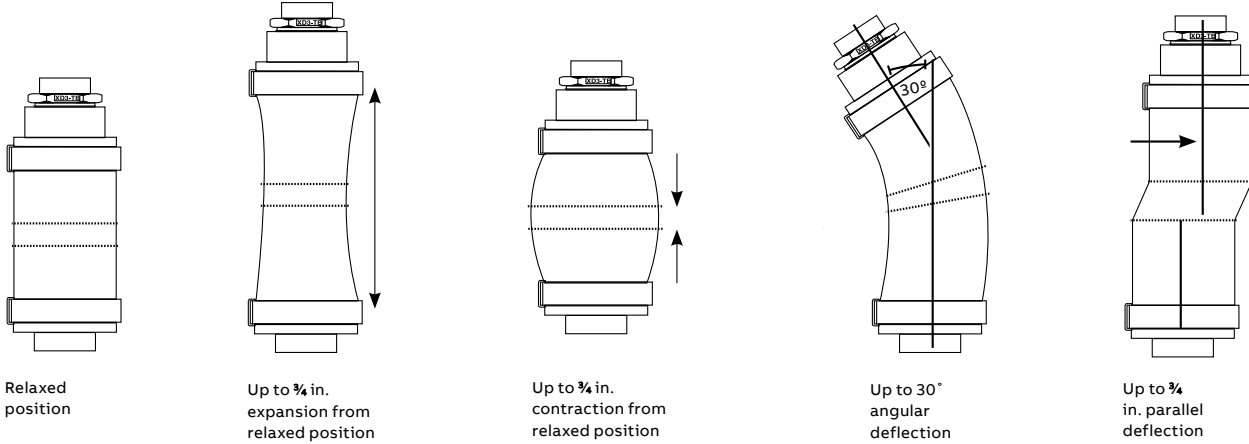

Cat. no. (in.)	Hub size	Dimensions (in.)			
		A	B	C	D
XD3-TB	1	9 <sup>13</sup> / <sub>16</sub>	8 <sup>15</sup> / <sub>32</sub>	6 <sup>7</sup> / <sub>16</sub>	3 <sup>11</sup> / <sub>32</sub>
XD4-TB	1 <sup>1</sup> / <sub>4</sub>	9 <sup>3</sup> / <sub>16</sub>	8 <sup>3</sup> / <sub>8</sub>	6 <sup>7</sup> / <sub>8</sub>	3 <sup>7</sup> / <sub>8</sub>
XD5-TB	1 <sup>1</sup> / <sub>2</sub>	9 <sup>1</sup> / <sub>4</sub>	8 <sup>7</sup> / <sub>32</sub>	6 <sup>3</sup> / <sub>4</sub>	4 <sup>5</sup> / <sub>32</sub>
XD6-TB	2	9 <sup>3</sup> / <sub>4</sub>	8 <sup>21</sup> / <sub>32</sub>	7 <sup>1</sup> / <sub>4</sub>	4 <sup>11</sup> / <sub>16</sub>
XD7-TB	2 <sup>1</sup> / <sub>2</sub>	11 <sup>3</sup> / <sub>4</sub>	11 <sup>3</sup> / <sub>8</sub>	8 <sup>1</sup> / <sub>2</sub>	4 <sup>7</sup> / <sub>8</sub>
XD8-TB	3	10 <sup>1</sup> / <sub>2</sub>	9 <sup>21</sup> / <sub>32</sub>	7 <sup>21</sup> / <sub>32</sub>	5 <sup>15</sup> / <sub>16</sub>
XD9-TB	3 <sup>1</sup> / <sub>2</sub>	10 <sup>9</sup> / <sub>16</sub>	9 <sup>3</sup> / <sub>4</sub>	7 <sup>3</sup> / <sub>4</sub>	6 <sup>3</sup> / <sub>8</sub>
XD010-TB	4	13 <sup>3</sup> / <sub>16</sub>	11 <sup>27</sup> / <sub>32</sub>	8 <sup>7</sup> / <sub>8</sub>	7 <sup>9</sup> / <sub>32</sub>
XD012-TB	5	14	12 <sup>15</sup> / <sub>16</sub>	11	8 <sup>9</sup> / <sub>32</sub>
XD014-TB	6	14 <sup>5</sup> / <sub>16</sub>	13 <sup>3</sup> / <sub>8</sub>	11 <sup>3</sup> / <sub>8</sub>	9 <sup>19</sup> / <sub>32</sub>

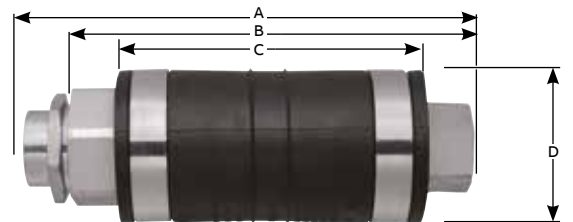

## Rigid and intermediate metal conduit fittings

### XJG conduit expansion couplings for rigid conduit

01 Slide the fitting onto the conduit until it stops at the internal sliding bushing. Tighten and you're ready. No parts to reassemble.

02 With a wrench, tighten the gland nut to compress the Teflon® packing, creating a raintight seal around the conduit.

03 Thread the next length of conduit into the other end of the fitting and tighten. You're done.

04 4" movement shown

05 8" Movement shown

**Easy to install – save time and money on the job. No disassembly required.**

Used where:

- Raceways require expansion fittings to compensate for thermal expansion and contraction
- Expansion fittings and telescoping sections of metal raceway must be made electrically continuous by bonding jumpers or other means

**Suggested specifications for expansion fittings for rigid steel or intermediate metal conduit.**

- Fitting will be constructed from cast iron with exterior and interior zinc plating for corrosion protection
- The fitting shall be constructed so that disassembly is not required during installation
- Fitting shall be raintight after installation

- The fitting shall have an internal bonding jumper constructed of a copper braid, sized to meet UL fault current test requirements and comply with bonding requirements – CEC article 10-612 and 10-614
- External bonding jumper shall not be required to comply with CEC requirements
- Accepted manufacturer: ABB – XJG-TB Series

#### Standard material/finish

- Body: Malleable or ductile iron, available PVC coated
- Internal bonding jumper: Copper braid
- Exterior and interior finish: Zinc plating, aluminum acrylic paint
- Packing: PTFE/synthetic fiber material (Teflon coated)

Teflon is a trademark of DuPont.



01



02



03



04

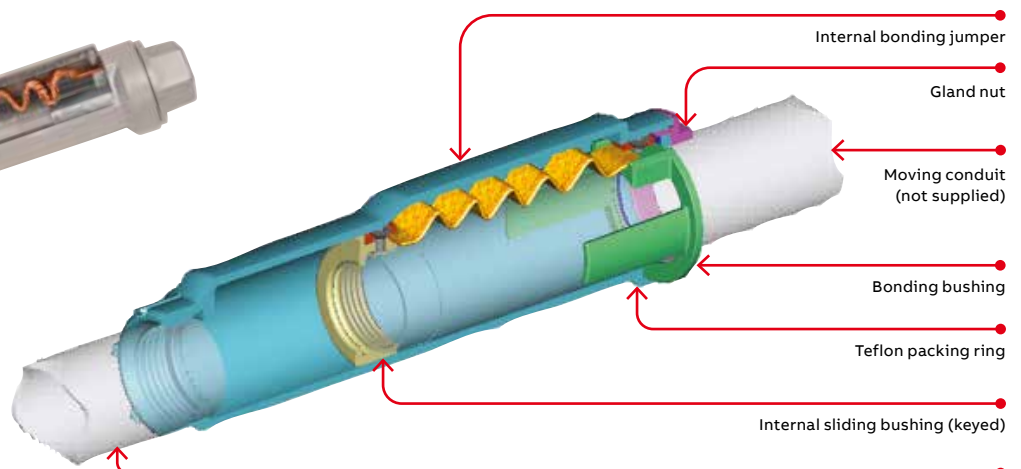

05

## Rigid and intermediate metal conduit fittings

XJG conduit expansion couplings for rigid conduit



Cat. no.	Size (in.)	Movement (in.)	Dimensions (in.)		
			A	B	C
XJG24-TB	¾	4	2.43	10.00	2.75
XJG28-TB	¾	8	2.43	14.00	2.75
XJG34-TB	1	4	2.67	10.00	2.99
XJG38-TB	1	8	2.67	14.00	2.99
XJG44-TB	1¼	4	3.36	10.56	3.68
XJG48-TB	1¼	8	3.36	14.56	3.68
XJG54-TB	1½	4	3.36	10.56	3.68
XJG58-TB	1½	8	3.36	14.56	3.68
XJG64-TB	2	4	3.86	11.25	4.18
XJG68-TB	2	8	3.86	15.25	4.18
XJG74-TB	2½	4	4.96	12.12	5.25
XJG78-TB	2½	8	4.96	16.12	5.25
XJG84-TB	3	4	4.96	12.12	5.25
XJG88-TB	3	8	4.96	16.12	5.25
XJG94-TB	3½	4	6.37	12.87	6.75
XJG98-TB	3½	8	6.37	16.87	6.75
XJG104-TB	4	4	6.37	12.87	6.75
XJG108-TB	4	8	6.37	16.87	6.75
XJG1208-TB	5	8	7.99	18.87	8.56



Also available in Ocal™ PVC coating and for EMT.

## Rigid and intermediate metal conduit fittings

### XJG-EMT conduit expansion couplings for EMT



#### Features

- Fast and easy installation – no disassembly required
- No external grounding strap needed – internal bonding jumper is protected from tampering and the environment

#### Standard material/finish

- Body: Malleable or ductile iron
- Internal bonding jumper: Tinned copper braid
- Exterior and interior finish: Zinc plating, aluminum acrylic paint
- Packing: PTFE/synthetic fiber material

#### Certifications/compliances

- CSA certified to C22.2 and UL Listed to UL 514B No. 18
- Suitable for wet locations (hub sizes 1 in.–2½ in.)
- NEC Article 250.98 compliant

Note: XJG-EMT couplings are not raintight and are for use in dry locations only. They are UL Listed for use with aluminum EMT.



Cat. no.	Size (in.)	Movement (in.)	A (length in.)	B (height in.)
XJG24-EMT	¾	4	17.39	2.75
XJG28-EMT	¾	8	21.39	2.75
XJG34-EMT	1	4	17.42	2.99
XJG38-EMT	1	8	21.42	2.99
XJG44-EMT	1¼	4	18.27	3.46
XJG48-EMT	1¼	8	22.27	3.46
XJG54-EMT	1½	4	18.69	3.68
XJG58-EMT	1½	8	22.69	3.68
XJG64-EMT	2	4	19.04	4.18
XJG68-EMT	2	8	23.04	4.18
XJG74-EMT	2½	4	23.23	4.52
XJG78-EMT	2½	8	27.23	4.52
XJG84-EMT	3	4	24.09	5.25
XJG88-EMT	3	8	28.09	5.25
XJG94-EMT	3½	4	28.70	6.00
XJG98-EMT	3½	8	28.70	6.00
XJG104-EMT	4	4	29.30	6.75
XJG108-EMT	4	8	29.30	6.75

Diagram

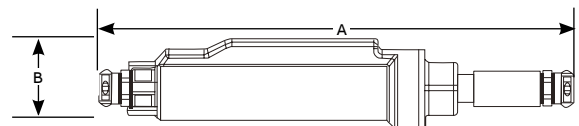

# Rigid and intermediate metal conduit fittings

## Rigid and capoffs



Offset reducers



Diagrams	Cat. no. zinc	Cat. no. aluminum	Trade size (in.)	Height (in.)	Diameter (in.)	Dimensions (in.)				
						A	B	C	D	E
	H150-075ORGR-TB	H150-075ORGRA-TB	1½-¾	1 <sup>25</sup> / <sub>32</sub>	2¾	1 <sup>5</sup> / <sub>16</sub>	2 <sup>3</sup> / <sub>32</sub>	1 <sup>29</sup> / <sub>32</sub>	1 <sup>9</sup> / <sub>32</sub>	1 <sup>11</sup> / <sub>32</sub>
	H150-100ORGR-TB	H150-100ORGRA-TB	1½-1	1 <sup>25</sup> / <sub>32</sub>	2¾	1 <sup>5</sup> / <sub>16</sub>	2 <sup>3</sup> / <sub>32</sub>	1 <sup>29</sup> / <sub>32</sub>	1 <sup>9</sup> / <sub>16</sub>	7 <sup>1</sup> / <sub>32</sub>
	H150-125ORGR-TB	H150-125ORGRA-TB	1½-1¼	1 <sup>25</sup> / <sub>32</sub>	2¾	1 <sup>5</sup> / <sub>16</sub>	2 <sup>3</sup> / <sub>32</sub>	1 <sup>29</sup> / <sub>32</sub>	1 <sup>7</sup> / <sub>8</sub>	1 <sup>1</sup> / <sub>32</sub>
	H250-200ORGR-TB	H250-200ORGRA-TB	2½-2	2½	3¾	1 <sup>5</sup> / <sub>16</sub>	1 <sup>5</sup> / <sub>16</sub>	2 <sup>29</sup> / <sub>32</sub>	2 <sup>21</sup> / <sub>32</sub>	3 <sup>1</sup> / <sub>32</sub>

Material – Offset reducer and locknut: Zinc or copper-free aluminum  
 Insulating throat: Thermoplastic temp. rating 105 °C; flammability rating 94V-0  
 Sealing ring: Nitrile (Buna N)  
 For chrome-plated offset reducer add suffix CP. (i.e. H150-125ORGRCP-TB)



Capoffs



Diagrams	Cat. no. zinc	Cat. no. aluminum	Trade size (in.)	Height (in.)	Diameter (in.)	Dimensions (in.)		
						A	B	C
	H050CAP	H050CAPA	½	1 <sup>13</sup> / <sub>32</sub>	1 <sup>1</sup> / <sub>16</sub>	1 <sup>9</sup> / <sub>32</sub>	2 <sup>7</sup> / <sub>32</sub>	3 <sup>1</sup> / <sub>16</sub>
	H075CAP	H075CAPA	¾	1 <sup>15</sup> / <sub>32</sub>	1 <sup>11</sup> / <sub>16</sub>	1 <sup>9</sup> / <sub>32</sub>	1 <sup>1</sup> / <sub>16</sub>	3 <sup>1</sup> / <sub>16</sub>
	H100CAP	H100CAPA	1	1 <sup>11</sup> / <sub>16</sub>	2	1 <sup>11</sup> / <sub>16</sub>	1 <sup>5</sup> / <sub>16</sub>	¾
	H125CAP	H125CAPA	1¼	1 <sup>25</sup> / <sub>32</sub>	2 <sup>3</sup> / <sub>8</sub>	2 <sup>3</sup> / <sub>32</sub>	1 <sup>21</sup> / <sub>32</sub>	¾
	H150CAP	H150CAPA	1½	1 <sup>13</sup> / <sub>16</sub>	2¾	2 <sup>3</sup> / <sub>32</sub>	1 <sup>29</sup> / <sub>32</sub>	¾
	H200CAP	H200CAPA	2	1 <sup>27</sup> / <sub>32</sub>	3¾	2 <sup>3</sup> / <sub>32</sub>	2 <sup>3</sup> / <sub>8</sub>	¾
	H250CAP	H250CAPA	2½	2 <sup>9</sup> / <sub>32</sub>	3¾	7 <sup>1</sup> / <sub>8</sub>	2 <sup>29</sup> / <sub>32</sub>	¾
	H300CAP	H300CAPA	3	2 <sup>9</sup> / <sub>16</sub>	4 <sup>3</sup> / <sub>8</sub>	7 <sup>1</sup> / <sub>8</sub>	3 <sup>1</sup> / <sub>32</sub>	1 <sup>11</sup> / <sub>32</sub>
	H350CAP	H350CAPA	3½	2 <sup>9</sup> / <sub>16</sub>	5	2 <sup>9</sup> / <sub>32</sub>	4 <sup>1</sup> / <sub>32</sub>	1 <sup>11</sup> / <sub>32</sub>
	H400CAP	H400CAPA	4	2 <sup>9</sup> / <sub>16</sub>	5½	2 <sup>9</sup> / <sub>32</sub>	4½	1 <sup>11</sup> / <sub>32</sub>
	H500CAP	H500CAPA	5	2 <sup>23</sup> / <sub>32</sub>	6 <sup>3</sup> / <sub>8</sub>	2 <sup>9</sup> / <sub>32</sub>	5 <sup>9</sup> / <sub>16</sub>	1 <sup>11</sup> / <sub>32</sub>
	H600CAP	H600CAPA	6	3	7 <sup>5</sup> / <sub>8</sub>	3 <sup>1</sup> / <sub>32</sub>	6 <sup>5</sup> / <sub>8</sub>	1 <sup>11</sup> / <sub>32</sub>

Material – Capoff and locknut: Zinc or copper-free aluminum  
 Insulating throat: Thermoplastic temp. rating 105 °C; flammability rating 94V-0  
 Sealing ring: Nitrile (Buna N)  
 For chrome-plated capoff add suffix CP. (i.e. H050CAPCP)

## Rigid and intermediate metal conduit fittings

Threadless fittings/couplings for threadless rigid metal conduit and intermediate metal conduit

—  
01 8123 Series

—  
02 8130 Series

—  
03 8120 Series

### Application

- To connect and effectively bond threadless rigid metal conduit/intermediate metal conduit to a box or enclosure, or to couple ends of threadless conduit

### Features

- Steel/malleable iron construction
- Case-hardened ring bites into conduit for high quality continuity and grip
- Nylon insulator firmly secured in place protects conductors and reduces wire pulling effort by as much as 50%; prevents thread damage in handling
- Case-hardened steel or malleable iron locknut designed to provide a positive bond
- Suitable for concrete-tight application
- Raintight application
- Capable of carrying ground fault currents up to 10,000 amps RMS (½ in. through 1½ in. size) and 20,000 amps RMS (2 in. and above sizes), duration of current 3 cycles

### Standard material

- Nut, gland: ½ in. to 1 in. steel, 1¼ in. to 4 in. malleable iron
- Body: All malleable iron
- Ring: Steel (case-hardened)
- Insulator: Nylon
- Locknut: ½ in. through 2 in. steel (hardened) 2 in. through 4 in. malleable iron

### Standard finish

- Electro zinc plated and chromate coated

### Range

- 8123 and 8120 Series: ½ in. through 4 in. size conduit
- 8130 Series: ½ in. and ¾ in. size conduit
- All hub threads: Straight pipe (NPS)

### Conformity

- UL 514B
- CSA C22.2 No. 18.3
- ANSI C80.4
- NFPA 70-2008 (ANSI)
- NEMA FB-1
- Federal Specification W-F-408
- Federal Standard H-28 (Threads)



—  
01

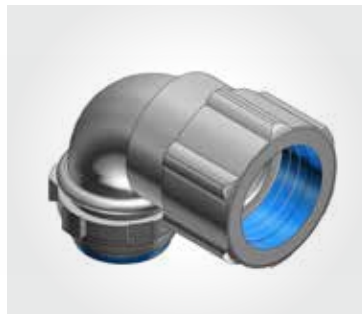

—  
02

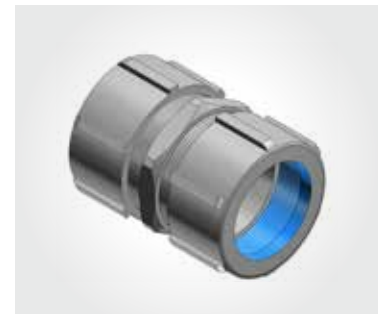

—  
03

## Rigid and intermediate metal conduit fittings

### Threadless fittings



A split steel ring with diagonal serrations grips the conduit and bites into it for positive ground. Makes a permanent connection and eliminates the need for cutting a thread on the conduit. Insulation helps

to guarantee continuity of service with protection of the conductor at the critical point – the fitting bushing. Malleable iron construction.

#### Nylon-insulated threadless fittings



Diagram	Cat. no.		Conduit size (in.)	Dimensions (in.)		
	Nylon insulated	Non-insulated		A	B	C
	8123	8121	1/2	1 11/32	1 15/16	3/4
	8223	8221	3/4	1 5/8	2	3/4
	8323	8321	1	1 7/8	2 7/16	7/8
	8423	8421	1 1/4	2 3/8	2 9/16	1 1/16
	8523	8521	1 1/2	2 5/8	2 3/4	3/4
	8623	8621	2	3 1/4	2 15/16	2 7/32
	8723-TB	8721	2 1/2	3 15/16	3 15/16	1 1/8
	8823-TB	8821	3	4 11/16	4 1/8	1 7/32
	8853	8851	3 1/2	5 3/16	4 1/4	1 1/8
	8973	8971	4	5 11/16	5	1 1/8



#### Threadless couplings

Eliminate conduit threading. When tightened with a wrench, they make a UL Listed and CSA Certified concrete-tight connection. Malleable iron construction.



Diagram	Cat. no.	Size (in.)	Dimensions (in.)	
			A	B
	8120	1/2	1 3/32	2
	8220	3/4	1 19/32	2 5/16
	8320	1	1 7/8	2 11/16
	8420	1 1/4	2 3/8	2 13/16
	8520	1 1/2	2 5/8	3 5/8
	8620	2	3 1/4	3 13/16
	8720	2 1/2	3 15/16	5 3/8
	8820	3	4 11/16	5 1/2
	8850	3 1/2	5 3/16	5 1/2
	8970	4	5 11/16	5 1/2



#### Threadless short elbows – Nylon-insulated

Ideal for entering enclosure or conduit body at right angles. Eliminates need to thread conduit. As with straight couplings, this fitting makes a concrete-tight connection. Malleable iron construction.



Diagram	Cat. no.	Size (in.)	Dimensions (in.)		
			A	B	C
	8130	1/2	1 11/32	1 1/2	1/2
	8131	3/4	1 5/8	1 3/4	9/16
	8132	1	1 7/8	1 15/16	1 1/16
	8134	1 1/2	2 23/32	3 1/8	1 3/16



## Rigid and intermediate metal conduit fittings

Set-screw fittings/couplings for threadless rigid metal conduit and intermediate metal conduit

—  
01 8125 Series  
—  
02 8124 Series

### Application

- To connect and effectively bond threadless rigid metal conduit or intermediate metal conduit to a box or enclosure or to couple ends of threadless conduit

### Features

- Thickwall steel or malleable iron body
- Hardened hex head cup point screw to provide high quality bond
- Captive screw, will not vibrate loose
- Nylon-insulated throat meets and exceeds all codes requirements for bushing:
  - (1) Prevents thinning of insulation
  - (2) Reduces installation effort
  - (3) Prevents first thread damage
- Coupling provided with positive center stop
- Suitable for concrete-tight application
- Capable of carrying ground fault currents up to 10,000 amps RMS ( $\frac{1}{2}$  through  $1\frac{1}{2}$  in. size) and 20,000 amps RMS (2 in. and above sizes)

### Standard material

- Body:  $\frac{1}{2}$  in. through 2 in. steel  
2 $\frac{1}{2}$  in. through 4 in. malleable iron
- Locknut:  $\frac{1}{2}$  in. through 2 in. steel (hardened)  
2 $\frac{1}{2}$  in. through 4 in. malleable iron
- Screw: Steel (hardened)
- Insulator: Nylon

### Standard finish

- Electro zinc plated and chromate coated

### Conformity

- UL 514B
- CSA C22.2 No. 18.3
- ANSI C80.4
- NFPA 70-2008 (ANSI)
- NEMA FB-1
- Federal Specification W-F-408
- Federal Standard H-28 (Threads)



—  
01



—  
02

## Rigid and intermediate metal conduit fittings

Set-screw fittings/couplings for threadless rigid metal conduit and intermediate metal conduit



Eliminate conduit threading with these set-screw fittings. Captive hex head screws tighten down onto conduit for positive holding strength and ground. The fittings are furnished with insulated throats, reducing wire pulling effort by as much as 50%. Approved concrete-tight.

### Insulated set-screw fittings



Diagram	Cat. no.	Conduit size (in.)	Dimensions (in.)	
			A	B
	8125	1/2	1 3/8	13/32
	8225	3/4	1 1/2	7/16
	8325	1	1 13/16	35/64
	8425-TB	1 1/4	2	5/8
	8525-TB	1 1/2	2 5/16	5/8
	8625	2	2 7/16	11/16
	8725-TB	2 1/2	3 3/8	1
	8825-TB	3	3 7/16	1
	8855	3 1/2	3 3/8	1 1/16
	8975	4	4 3/16	1 1/8

Sizes 1/2 in.–2 in. made of steel. Sizes 2 1/2 in.–4 in. are malleable iron



Eliminate the need for threading conduit ends when joining rigid conduit with these set-screw couplings. Captive hex head screws provide positive holding strength and ground continuity. Approved concrete-tight.

### Set-screw couplings



Diagram	Cat. no.	Conduit size (in.)	Dimensions (in.)
			A
	8124	1/2	2 1/2
	8224	3/4	2 11/16
	8324-TB	1	2 27/32
	8424	1 1/4	3
	8524	1 1/2	3 3/8
	8624	2	3 3/8
	8724-TB	2 1/2	3 3/8
	8824-TB	3	4 1/4
	8974	4	5 3/8

Sizes 1/2 in.–2 in. made of steel; sizes 2 1/2 in.–4 in. are malleable iron

# Rigid and intermediate metal conduit fittings

## Elbows



Bushed elbows

The non-insulated elbow has smoothly rounded shoulders to protect conductor insulation. Malleable iron.



Diagram	Cat. no.	Size (in.)	Dimensions (in.)		
			A	B	C
	460TB	1/2	1 13/16	1 3/8	5/8
	461TB	3/4	2 1/4	1 1/2	9/16
	462	1	2 23/32	1 23/32	11/16
	463	1 1/4	3 3/8	2 1/16	25/32



Short elbows – Nylon-insulated

The integral insulation of the insulated elbow is a guarantee that the bushing of every fitting will be smooth. Malleable iron.



Diagram	Cat. no.	Size (in.)	Dimensions (in.)		
			A	B	C
	4290	1/2	1 7/32	1 1/4	1/2
	4291	3/4	1 7/16	1 5/16	9/16
	4292	1	1 23/32	1 9/16	11/16
	4293	1 1/4	2 7/32	2 1/16	13/16
	4294	1 1/2	2 15/32	2 3/16	13/16

Not UL Listed

When an insulated elbow is not desired, the non-insulated short elbow should be used. Malleable iron.

Short elbows



Diagram	Cat. no.	Size (in.)	Dimensions (in.)		
			A	B	C
	4250	1/2	1 5/16	1 1/4	7/16
	4251	3/4	1 17/32	1 5/16	1/2
	4252	1	1 13/16	1 9/16	5/8
	4253	1 1/4	2 9/32	2 1/16	11/16
	4254-TB	1 1/2	2 9/16	2 3/16	11/16
	4255-TB	2	3 3/32	2 9/16	11/16

## Rigid and intermediate metal conduit fittings

Threaded (ERICKSON®) couplings for threaded rigid metal conduit and intermediate metal conduit



—  
674 Series  
675AL Series

### Application

- To couple and effectively bond threaded ends of rigid metal conduit/intermediate metal conduit where neither length of conduit can be rotated

### Features

- Malleable Iron/steel/copper-free aluminum construction
- Free-fitting threads ensure easy assembly
- Permits conduit coupling without rotating either conduit
- Provides rigid in-line coupling with high quality grounding; will not loosen under vibration
- Suitable for concrete-tight application.
- Capable of carrying ground fault currents up to 10,000 amps RMS (½ in. through 1½ in. size) and up to 20,000 amps RMS (2 in. and above) (duration of fault current 3 cycles) (674 series tested)

### Standard material

#### 674 Series

- Bushing and body: malleable iron
- Ring: steel up to 2 in. or malleable iron

#### 675AL Series

- Bushing and body: aluminum
- Ring: aluminum



—  
ERICKSON couplings

### Standard finish

- 674 Series: Electro zinc plated and chromate coated
- 675AL Series: Degreased

### Range

- 674 Series: ⅜ in. through 6 in. conduit
- 675AL Series: ½ in. through 6 in. conduit
- All straight pipe threads (NPS)

### Conformity

- UL 514B
- CSA C22.2 No. 18.3
- NEMA FB1
- ANSI C80.4
- NFPA 70-2008 (ANSI)
- Federal Specification W-F-408
- Federal Standard H-28 (Threads)

With an ERICKSON coupling, a conduit run may be completed when neither conduit can be turned. A conduit run may also be broken without taking down the whole run. Conduit joined with ERICKSON couplings is rigid and in line, and vibration will not loosen the connections.



Diagram	Cat. no.		Size (in.)	Dimensions (in.)	
	Mal. iron	Alum.*		A	B
	674	—	⅜	1⅞	1⅞
	675	675AL	½	1 <sup>15</sup> / <sub>32</sub>	1¾
	676-TB	676AL	¾	1 <sup>9</sup> / <sub>16</sub>	1 <sup>13</sup> / <sub>32</sub>
	677	677AL	1	1 <sup>29</sup> / <sub>32</sub>	1⅝
	678	678AL	1¼	2⅜	1 <sup>13</sup> / <sub>16</sub>
	679	679AL	1½	2⅝	1 <sup>31</sup> / <sub>32</sub>
	680-TB	680AL	2	3 <sup>7</sup> / <sub>32</sub>	2 <sup>7</sup> / <sub>32</sub>
	681	681AL	2½	3 <sup>3</sup> / <sub>32</sub>	2 <sup>11</sup> / <sub>16</sub>
	682	682AL	3	4 <sup>7</sup> / <sub>16</sub>	2 <sup>29</sup> / <sub>32</sub>
	683	683AL	3½	5	3
	684	684AL	4	5½	3 <sup>3</sup> / <sub>16</sub>
	685	685AL†	4½	6¼	3 <sup>15</sup> / <sub>32</sub>
	686	686AL	5	6 <sup>25</sup> / <sub>32</sub>	3¾
	687	687AL	6	8	4 <sup>1</sup> / <sub>32</sub>

\* Copper-free aluminum (less than 0.4% copper)

UL Listed and CSA Certified concrete-tight

† Not CSA Certified

## Rigid and intermediate metal conduit fittings

### Extensions and enlargers

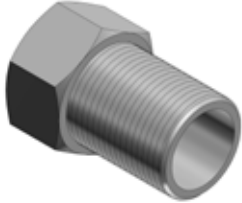

Ideal when longer thread length is needed. Will combine with any fitting having a male thread. Male thread of panel fitting extension is 1 in. long. Malleable iron.

#### Panel fitting extensions



Diagram	Cat. no.	Size (in.)	Dimensions (in.)		
			A	B	C
	1440	$\frac{1}{2}$	$1\frac{3}{4}$	$1\frac{3}{16}$	$1\frac{7}{8}$
	1441	$\frac{3}{4}$	$1\frac{3}{4}$	$1\frac{13}{32}$	$1\frac{15}{16}$
	1442	1	$1\frac{3}{16}$	$1\frac{21}{32}$	$1\frac{15}{16}$
	1443	$1\frac{1}{4}$	$1\frac{3}{4}$	$2\frac{1}{8}$	2

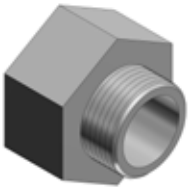

Adapt an outlet hole to the next larger size of conduit. Rough ends of conduit carefully covered by built-in bushing. Malleable iron.

#### Male enlargers



Diagram	Cat. no.	Size (in.)	Dimensions (in.)		
			A	B	C
	1245	$\frac{1}{2}$	$1\frac{3}{4}$	$1\frac{3}{16}$	$1\frac{7}{8}$
	1246-TB	$\frac{3}{4}$	$1\frac{3}{4}$	$1\frac{13}{32}$	$1\frac{15}{16}$
	1244	1	$1\frac{3}{16}$	$1\frac{21}{32}$	$1\frac{15}{16}$
	1247	$1\frac{1}{4}$	$1\frac{3}{4}$	$2\frac{1}{8}$	2

## Rigid and intermediate metal conduit fittings

### Reducers

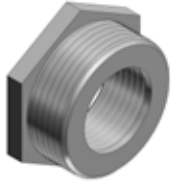

Female reducers

Adapt an outlet hole to the next larger size of conduit. Rough ends of conduit carefully covered by built-in bushing. Malleable iron.



Diagram	Cat. no.	Size (in.)	Dimensions (in.)		
			A	B	C
	1250-TB	3/4-1/2	1 1/8	5/8	3/16
	1261	1-1/2	1 7/16	1 1/16	3/16
	1251	1-3/4	1 3/8	1 1/16	3/16
	1262	1 1/4-1/2	1 13/16	2 1/32	3/16
	1263	1 1/4-3/4	1 13/16	2 3/32	3/16
	1252	1 1/4-1	1 3/4	2 5/32	7/32
	1253	1 1/2-1 1/4	2	1 3/16	1/4
	1254	2-1 1/2	2 3/8	1 3/16	9/32
	1255	2 1/2-2	3	1 1/4	3/8
	1256	3-2 1/2	3 5/8	1 1/2	1/2
	1257	3 1/2-3	4 1/8	1 9/16	1/2
	1258	4-3 1/2	4 5/8	1 3/16	1/2

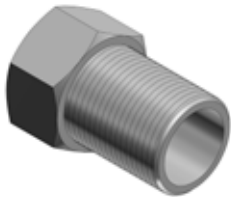

Threaded reducers

For reducing the threaded opening in conduit bodies or any female threaded fitting. Smooth, built-in bushing completely covers rough ends of conduit. Iron or steel construction. Steel from 600-TB through 606-TB, also 614 and 615.



Diagram	Cat. no.		Size (in.)	Dimensions (in.)
	Stl. or M.I.	Alum.		A
	600-TB	600AL-TB	1/2-3/8	3/8
	601-TB	601AL-TB	3/4-1/2	19/32
	602-TB	602AL-TB	1-1/2	19/32
	603-TB	603AL-TB	1-3/4	19/32
	604-TB	604AL-TB	1 1/4-1/2	19/32
	605-TB	605AL	1 1/4-3/4	19/32
	606-TB	606AL	1 1/4-1	1 1/16
	607	607AL	1 1/2-1/2	1 5/16
	608	608AL	1 1/2-3/4	1 5/16
	609	609AL	1 1/2-1	1 3/32
	610-TB	610AL	1 1/2-1 1/4	2 7/32
	611-TB	611AL	2-1/2	2 3/32
	612	612AL	2-3/4	1 1/16
	613	613AL	2-1	1 1/16
	614-TB	614AL	2-1 1/4	1 1/16
615-TB	615AL	2-1 1/2	2 7/32	

## Rigid and intermediate metal conduit fittings

### Reducing washers



Washers reduce knockout hole in outlet box. Newly designed of galvanized steel. These washers, used in pairs, interlock and form a rib that centers the washers and conduit in the knockout.

#### Reducing washers



Diagram	Cat. no.	Size (in.)	Dimensions (in.)	
			A	B
	3700	$\frac{3}{4}$ – $\frac{3}{8}$	$1\frac{3}{8}$	$\frac{45}{64}$
	3701	$\frac{3}{4}$ – $\frac{1}{2}$	$1\frac{3}{8}$	$\frac{7}{8}$
	3702-TB	$1$ – $\frac{3}{8}$	$1\frac{5}{8}$	$\frac{45}{64}$
	3703	$1$ – $\frac{1}{2}$	$1\frac{5}{8}$	$\frac{7}{8}$
	3704	$1$ – $\frac{3}{4}$	$1\frac{5}{8}$	$1\frac{3}{32}$
	3705-TB	$1\frac{1}{4}$ – $\frac{3}{8}$	2	$\frac{45}{64}$
	3706-TB	$1\frac{1}{4}$ – $\frac{1}{2}$	2	$\frac{7}{8}$
	3707	$1\frac{1}{4}$ – $\frac{3}{4}$	2	$1\frac{3}{32}$
	3708	$1\frac{1}{4}$ –1	2	$1\frac{23}{64}$
	3709	$1\frac{1}{2}$ – $\frac{3}{8}$	$2\frac{1}{4}$	$\frac{45}{64}$
	3710	$1\frac{1}{2}$ – $\frac{1}{2}$	$2\frac{1}{4}$	$\frac{7}{8}$
	3711	$1\frac{1}{2}$ – $\frac{3}{4}$	$2\frac{1}{4}$	$1\frac{3}{32}$
	3712	$1\frac{1}{2}$ –1	$2\frac{1}{4}$	$1\frac{23}{64}$
	3713	$1\frac{1}{2}$ – $1\frac{1}{4}$	$2\frac{1}{4}$	$1\frac{23}{32}$
	3714	$2$ – $\frac{1}{2}$	$2\frac{3}{4}$	$\frac{7}{8}$
	3715-TB	$2$ – $\frac{3}{4}$	$2\frac{3}{4}$	$1\frac{3}{32}$
	3716	$2$ –1	$2\frac{3}{4}$	$1\frac{23}{64}$
	3717	$2$ – $1\frac{1}{4}$	$2\frac{3}{4}$	$1\frac{23}{32}$
3718	$2$ – $1\frac{1}{2}$	$2\frac{3}{4}$	$1\frac{31}{32}$	

## Rigid and intermediate metal conduit fittings

Conduit straps for threaded rigid metal conduit and intermediate metal conduit



—  
1275 Series  
1276AL Series

**Application**

- To support and securely fasten rigid metal conduit and intermediate metal to the supporting surface

**Features**

- Rugged malleable iron/copper-free aluminum construction – snugly fits on the conduit
- Designed to prevent accumulation of moisture and start of corrosion on vertical run of conduit (A)

**Standard material**

**1275 Series**

- Malleable Iron

**1976AL Series**

- All copper-free aluminum

**Standard finish**

**1275 Series**

- Hot dipped galvanized

**1276AL Series**

- As cast

**Range**

- 1275 Series  
3/8 in. through 6 in. conduit
- 1276AL Series  
1/2 in. through 6 in. conduit

**Conformity**

- CSA C22.2 No. 18.3
- ANSI C80.4
- NFPA 70-2008 (ANSI)

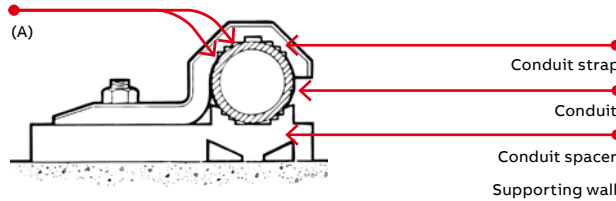

Pipe straps – Malleable iron or aluminum



Diagram	Cat. no.		Size (in.)	Dimensions (in.)			Screw size (in.)
	Mal. iron	Alum.		A	B	C	
<p>Designed to fit each size of conduit snugly. High reinforcing ribs on each side increase strength, reduce weight. Hot-dipped galvanized finish.</p>	1275†	1275AL	3/8	1 <sup>15</sup> / <sub>16</sub>	<sup>19</sup> / <sub>32</sub>	1/4	1/4
	1276†	1276AL†	1/2	2 <sup>11</sup> / <sub>32</sub>	<sup>23</sup> / <sub>32</sub>	1/2	1/4
	1277†	1277AL†	3/4	2 <sup>11</sup> / <sub>16</sub>	<sup>21</sup> / <sub>32</sub>	5/8	1/4
	1278†	1278AL†	1	3 <sup>3</sup> / <sub>32</sub>	<sup>11</sup> / <sub>16</sub>	<sup>13</sup> / <sub>16</sub>	1/4
	1279-TB†	1279AL†	1 1/4	4 1/8	<sup>13</sup> / <sub>16</sub>	<sup>29</sup> / <sub>32</sub>	5/16
	1280†	1280AL	1 1/2	4 1/2	<sup>15</sup> / <sub>16</sub>	1 <sup>17</sup> / <sub>32</sub>	3/8
	1281	1281AL	2	5 <sup>3</sup> / <sub>16</sub>	1 1/8	1 1/4	7/16
	1282*	1282AL	2 1/2	5 <sup>15</sup> / <sub>16</sub>	1 1/2	1 3/4	1/2
	1283*	1283AL	3	6 <sup>11</sup> / <sub>16</sub>	1 5/8	2 <sup>3</sup> / <sub>16</sub>	1/2
	1284	1284AL	3 1/2	7 <sup>19</sup> / <sub>32</sub>	1 3/4	2 3/4	5/8
	1285*	1285AL	4	8 <sup>3</sup> / <sub>16</sub>	1 7/8	2 <sup>13</sup> / <sub>16</sub>	5/8
	1286**	1286AL**	4 1/2	9 <sup>3</sup> / <sub>16</sub>	1 <sup>15</sup> / <sub>16</sub>	2 <sup>15</sup> / <sub>16</sub>	5/8
	1287	1287AL	5	9 <sup>15</sup> / <sub>16</sub>	2	3 1/4	5/8
	1288	1288AL	6	11 1/2	2 <sup>7</sup> / <sub>16</sub>	4 1/8	5/8

\* May be used with EMT of same size

† Not snap-on type

UL not applicable

\*\* Not CSA Certified



## Rigid and intermediate metal conduit fittings

Conduit straps for threaded rigid metal conduit and intermediate metal conduit



Elongated bolt hole makes alignment easy, even when holes in mounting surface are off center. Snap-on features. Steel. Zinc plated.

### Pipe straps – Steel



Diagram	Cat. no.	Conduit size (in.)	Dimensions (in.)			Screw size (in.)
			A	B	C	
	1210C†	3/8	1 <sup>15</sup> / <sub>32</sub>	3/4	1 <sup>11</sup> / <sub>16</sub>	1/4
	1211C	1/2	2	3/4	1 <sup>5</sup> / <sub>16</sub>	1/4
	1212C	3/4	2 <sup>9</sup> / <sub>16</sub>	3/4	1	1/4
	1213C	1	3 <sup>13</sup> / <sub>16</sub>	3/4	1 <sup>17</sup> / <sub>64</sub>	1/4
	1214TB*	1 1/4	2 <sup>31</sup> / <sub>32</sub>	1 <sup>9</sup> / <sub>16</sub>	1 <sup>9</sup> / <sub>16</sub>	3/8
	1215TB*	1 1/2	3 <sup>23</sup> / <sub>32</sub>	1 <sup>13</sup> / <sub>16</sub>	1 <sup>13</sup> / <sub>16</sub>	3/8
	1216TB*	2	4 <sup>7</sup> / <sub>16</sub>	2 <sup>9</sup> / <sub>16</sub>	2 <sup>5</sup> / <sub>16</sub>	3/8

† Not snap-on type  
 UL not applicable  
 \* Not CSA Certified



Malleable iron. Designed to fit each size of conduit snugly. High reinforcing ribs on each side increase strength, reduce weight.

### Corrosion-resistant PVC-coated rigid conduit straps



Diagram	Cat. no.	Size (in.)	Bolt size (in.)	Dimensions (in.)		
				A	B	C
	1275CR	3/8	1/4	2	2 <sup>1</sup> / <sub>32</sub>	1/4
	1276CR	1/2	1/4	2 <sup>13</sup> / <sub>32</sub>	2 <sup>5</sup> / <sub>32</sub>	1/2
	1277CR	3/4	1/4	2 <sup>3</sup> / <sub>4</sub>	2 <sup>9</sup> / <sub>32</sub>	5/8
	1278CR	1	1/4	3 <sup>9</sup> / <sub>32</sub>	3/4	1 <sup>3</sup> / <sub>16</sub>
	1279CR	1 1/4	3/8	4 <sup>9</sup> / <sub>32</sub>	2 <sup>5</sup> / <sub>32</sub>	7/8
	1280CR	1 1/2	3/8	4 <sup>9</sup> / <sub>16</sub>	1	1 <sup>7</sup> / <sub>32</sub>
	1281CR	2	1/2	5 <sup>1</sup> / <sub>4</sub>	1 <sup>3</sup> / <sub>16</sub>	1 1/4

UL not applicable

## Rigid and intermediate metal conduit fittings

Conduit spacers for rigid metal conduit, intermediate metal conduit and electrical metal tubing

—  
01 1350 Series  
1350AL Series

### Application

- Provides mounting surface for conduit where installation requires air space between conduit and supporting surface

### Features

- Prevents conduit rusting from wall condensation
- Spacers can be stacked one atop the other, facilitating installation and eliminating expensive conduit off setting (A)
- Designed to cover wide range; marked with accurate size marking for proper positioning (B)

### Standard material

#### 1350 Series

- Malleable Iron

#### 1350AL Series

- Copper-free aluminum

### Standard finish

### 1350 Series

- Hot-dipped galvanized

### 1350AL Series

- As cast

### Range

- ½ in. through 6 in. conduit

### Conformity

- CSA C22.2 No. 18.3
- ANSI C80.4
- NFPA 70-2008 (ANSI)



—  
01

### Diagrams

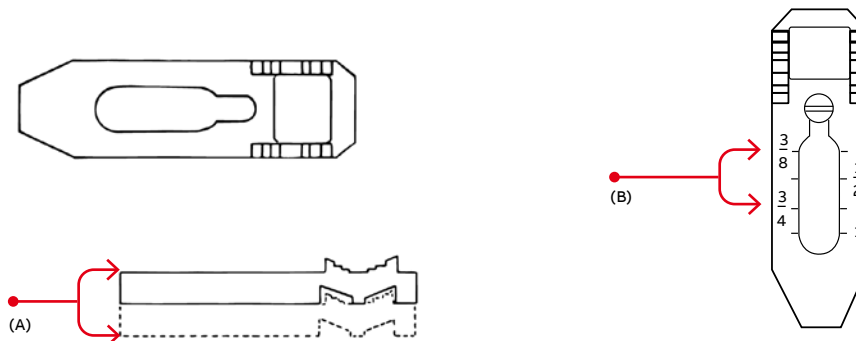

## Rigid and intermediate metal conduit fittings

Conduit spacers for rigid metal conduit, intermediate metal conduit and electrical metal tubing



Used with conduit straps to permit space between conduit and mounting surface. Eliminates need for costly offset-bending conduit and possible corrosive moisture traps when conduit is mounted directly to a surface. Hot-dipped galvanized finish, premountable and stackable to eliminate offsetting.

Pipe spacers



Diagram	Cat. no.		Size (in.)	Screw size	Dimensions (in.)	
	Mal. Iron	Alum.			A	B
	1350	1350AL	3/8, 1/2, 3/4, 1	#7	3	7/8
	1351	1351AL	1 1/4-1 1/2-2	#12	5	1 3/16
	1352	1352AL	2 1/2-3	#12	9 9/16	1 3/4
	1353	1353AL	3 1/2-4	#14	7 9/16	2

Conforms to CEC Rule 12-012 (5)  
UL not applicable



Corrosion-resistant PVC-coated malleable iron. Pre-mountable, stackable to eliminate offsetting. Spacers can be stacked for offsets on wall or into outlet box.

Prevents conduit rusting from wall condensation. Eliminates offsetting of conduit.

Pipe spacers – PVC coated



Diagram	Cat. no.	Conduit size (in.)	Screw size	Dimensions (in.)	
				A	B
	1350CR	1/2-3/4-1	#7	3	7/8
	1351CR	1 1/4-1 1/2-2	#12	5	3/8
	1352CR	2 1/2-3	#12	6 9/16	1 3/4
	1353CR	3 1/2-4	#14	7 9/16	2

Conforms to CEC Rule 12-012 (5)  
UL not applicable

## Rigid and intermediate metal conduit fittings

Couplings, beam clamps and conduit supports



A one-piece fitting that couples armoured cable or flexible conduit to threaded rigid conduit. Tite-Bite® wedge holds conduit securely with a double grip. With a Chase nipple, this fitting will connect flexible conduit to outlet boxes, allowing more wiring space in the box than the usual fitting. Malleable iron.

### Tite-Bite combination couplings – Armoured cable to threaded rigid



Diagram	Cat. no.	Size (in.)	Dimensions (in.)	
			A	B
	440-TB	1/2	1 1/8	1 27/32
	441	3/4	1 3/4	2 1/8
	442-TB	1	2	2 17/32



Steel. Includes bolts.

### Beam clamps – Adjustable



Cat. no.	Description
700TB	Fits flange 2 3/4 in. – 7 5/8 in.
703*	Special bolt and 3 nuts

\* Not CSA Certified



These supports will fit any flange, tapered or straight up to 5/8 in. thick. The broad hook holds the conduit at any desired angle. Holds standard rigid conduit, EMT, or IMC. Malleable iron.

### Conduit supports



Cat. no.	Size (in.)
690TB	1/2
691TB	3/4
692TB	1
693TB	1 1/4

## Stainless steel conduit and fittings

### Stainless steel conduit



#### Withstand corrosive environments and meet stringent sanitary requirements.

For corrosion-resistant electrical conduit systems, stainless steel offers value and performance that's hard to match, combining high corrosion, chemical and temperature resistance with strength, durability, ease of installation and low maintenance. Compared to standard galvanized steel conduit in corrosive environments, type 304 stainless steel offers up to five times the lifespan, while type 316 offers up to eight times the lifespan. Because it is very easy to clean and its surface has no pores or cracks to harbor bacteria and other impurities, stainless steel also provides one of the most hygienic surfaces.

- Available in both type 304 and marine-grade type 316 stainless steel
- Features standard NPT threads for easy installation

- Each 10-ft. length of conduit ships with one stainless steel coupling included
- Couplings also sold separately
- Exceeds requirements for washdown applications
- Food- and potable water-safe
- Satisfies plant-cleanliness mandates from HACCP, FDA and various state agencies
- Meets ASTM A-321/SA-312 Standards
- UL®/cUL Listed

#### Typical applications

- Petrochemical refining/processing
- Water and wastewater treatment
- Food and beverage processing
- Marine and coastal facilities
- Pharmaceutical manufacturing
- Pulp and paper processing
- Other applications in corrosive environments or with strict hygiene requirements

#### Stainless steel rigid conduit

Cat. no.	Trade size (in.)	Weight (lbs./ft.)	Std. pkg. qty. ft.
<b>Type 304 stainless steel conduit with coupling</b>			
COND1/2SS	½	0.82	1,500
COND3/4SS	¾	1.09	1,000
COND1SS	1	1.61	700
COND11/4SS	1¼	2.18	350
COND11/2SS	1½	2.63	300
COND2SS	2	3.50	200
COND21/2SS	2½	5.59	120
COND3SS	3	7.27	90
COND4SS	4	10.08	40

Cat. no.	Trade size (in.)	Weight (lbs./ft.)	Std. pkg. qty. ft.
<b>Type 316 stainless steel conduit with coupling</b>			
COND1/2SST	½	0.82	1,500
COND3/4SST	¾	1.09	1,000
COND1SST	1	1.61	700
COND11/4SST	1¼	2.18	350
COND11/2SST	1½	2.63	300
COND2SST	2	3.50	200
COND21/2SST	2½	5.59	120
COND3SST	3	7.27	90
COND4SST	4	10.08	40



Note: Conduit sold in 10-ft. lengths. Each 10-ft. length ships with one coupling.

## Stainless steel conduit and fittings

### Stainless steel couplings and nipples

Withstand corrosive environments and meet stringent sanitary requirements.



#### Stainless steel couplings – Type 304



Cat. no.	Trade size (in.)	Weight (lbs./ea.)	Std. pkg. qty.
CPL1/2SS	½	0.22	100
CPL3/4SS	¾	0.28	50
CPL1SS	1	0.39	30
CPL11/4SS	1¼	0.55	25
CPL11/2SS	1½	0.77	25
CPL2SS	2	1.10	20
CPL21/2SS	2½	2.09	12
CPL3SS	3	3.15	16
CPL4SS	4	4.29	10
CPL5SS	5	7.70	4
CPL6SS	6	10.15	4



#### Stainless steel couplings – Type 316



Cat. no.	Trade size (in.)	Weight (lbs./ea.)	Std. pkg. qty.
CPL1/2SST	½	0.17	100
CPL3/4SST	¾	0.29	50
CPL1SST	1	0.34	30
CPL11/4SST	1¼	0.37	25
CPL11/2SST	1½	0.61	25
CPL2SST	2	0.90	20
CPL21/2SST	2½	1.87	12
CPL3SST	3	1.93	16
CPL4SST	4	3.97	10
CPL5SST	5	7.70	4
CPL6SST	6	10.15	4



#### Conduit Nipples



Cat. no.	Trade size (in.)	Length (in.)	Weight (lbs./ea.)	Std. pkg. qty.
<b>Type 304 Stainless Steel Nipples</b>				
NPL1/2X12SS	½	12	0.79	25
NPL3/4X12SS	¾	12	1.05	25
NPL1X12SS	1	12	1.54	20
NPL11/4X12SS	1¼	12	2.02	16
NPL11/2X12SS	1½	12	2.49	8
NPL2X12SS	2	12	3.30	9
<b>Type 316 Stainless Steel Nipples</b>				
NPL1/2X12SST	½	12	0.79	25
NPL3/4X12SST	¾	12	1.05	25
NPL1X12SST	1	12	1.54	20
NPL11/4X12SST	1¼	12	2.02	16
NPL11/2X12SST	1½	12	2.49	8
NPL2X12SST	2	12	3.30	9

## Stainless steel conduit and fittings

### Stainless steel elbows



Withstand corrosive environments and meet stringent sanitary requirements.

Standard radius elbows 90°



Cat. no.	Trade size (in.)	Radius "R"	Offset "C"	Straight end "D"	Weight (lbs./ea.)	Std. pkg. qty.
<b>Type 304 stainless steel elbows</b>						
ELL1/2SS	½	4	5.50	1.50	0.64	25
ELL3/4SS	¾	4.5	6.00	1.50	0.92	25
ELL1SS	1	5.75	7.63	1.88	1.69	20
ELL11/4SS	1¼	7.25	9.25	2.00	2.66	8
ELL11/2SS	1½	8.25	10.25	2.00	3.67	8
ELL2SS	2	9.5	11.50	2.00	5.31	6
<b>Type 316 stainless steel elbows</b>						
ELL1/2SST	½	4	5.50	1.50	0.64	25
ELL3/4SST	¾	4.5	6.00	1.50	0.92	25
ELL1SST	1	5.75	7.63	1.88	1.69	20
ELL11/4SST	1¼	7.25	9.25	2.00	2.66	8
ELL11/2SST	1½	8.25	10.25	2.00	3.67	8
ELL2SST	2	9.5	11.50	2.00	5.31	6

Diagram

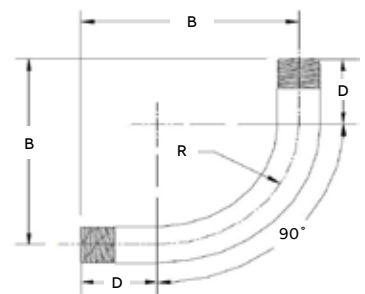

\* Minimum

## Stainless steel conduit and fittings

### Stainless steel elbows



Withstand corrosive environments and meet stringent sanitary requirements.

Standard radius elbows 45°



Cat. no.	Trade size (in.)	Radius "R"	Straight end "D"	Weight (lbs./ea.)	Std. pkg. qty.
<b>Type 304 stainless steel elbows</b>					
ELL1/245SS	½	4	1.50	0.42	25
ELL3/445SS	¾	4.5	1.50	0.61	25
ELL145SS	1	5.75	1.88	1.11	20
ELL11/445SS	1¼	7.25	2.00	1.70	16
ELL11/245SS	1½	8.25	2.00	2.30	16
ELL245SS	2	9.5	2.00	3.10	9
<b>Type 316 stainless steel elbows</b>					
ELL1/245SST	½	4	1.50	0.42	25
ELL3/445SST	¾	4.5	1.50	0.61	25
ELL145SST	1	5.75	1.88	1.11	20
ELL11/445SST	1¼	7.25	2.00	1.70	16
ELL11/245SST	1½	8.25	2.00	2.30	16
ELL245SST	2	9.5	2.00	3.10	9

Diagram

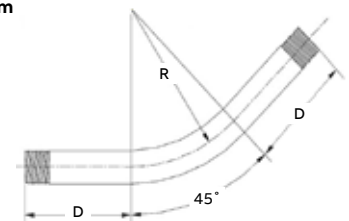

\* Minimum



## Couplings and accessories

### Stainless steel drain adapter and ball valve



In the electrical system of a food and beverage facility and elsewhere, the T&B® Fittings stainless steel drain adapter provides the means to drain accumulated moisture or small debris from stainless steel electrical enclosures for non-threaded connections.

- The drain adapter and ball valve are NSF certified for food and beverage applications
- When the drain adapter is used in conjunction with the ball valve, the assembly offers a UL type 4X rating and is suitable for washdown areas
- The adapter and valve are both constructed of type 316 stainless steel for superior corrosion resistance
- The innovative, compact body design and special-grade silicone gasket make the drain adapter suitable for installation in tight spaces and on curved surfaces

#### Certifications

- cULus listed type 4X when the ball valve is assembled to the drain adapter
- NSF certified per NSF/ANSI standard 169
- Manufactured with FDA-approved materials

Stainless steel drain adapter and ball valve

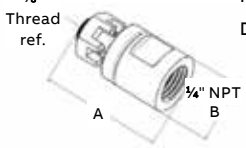
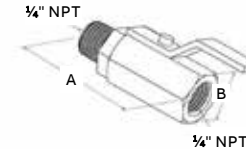
	Cat. no	Description	Trade size (in.)	Dim. (in.)	
				A	B
	FG-DA-3/8	Drain adapter	3/8	1.38	0.75
	DBV-1/4	Ball valve	1/4	2.03	0.75
					

## Conduit bodies and covers

### Overview



#### Application

Conduit bodies are installed in conduit systems to:

- Connect conduit sections
- Act as pull outlets when conductors are being installed
- Provide easy access for splices in branch conductors
- Make 90° bends in conduit runs
- Provide access to conductors for maintenance and future system changes

#### Features

- Standard features include tapered (NPT) threads and integral bushings to protect wire insulation
- T&B Fittings form 7 bodies and covers are interchangeable with other manufacturers' form 7 bodies and covers
- T&B Fittings form 8 bodies and covers are interchangeable with other manufacturers' Form 8 bodies and covers
- T&B Fittings form 9 bodies and covers are interchangeable with other manufacturers' Form 9 bodies and covers (Mark 9, FM 9)
- T&B Fittings form 7 and form 8 cast iron bodies feature BlueKote® internal coating for easier wire pulling
- Form 9 aluminum sand-cast copper-free aluminum alloy
- T&B Fittings series 35 bodies and covers are interchangeable with other manufacturers' 35/5 series iron and steel bodies and covers
- Form 7 sand cast aluminum is made with a special aluminum alloy, providing superior corrosion resistance as cast; no protective coatings needed
- Special sand cast aluminum alloy makes these conduit bodies ideal for use in food and beverage, pharmaceutical, chemical processing and other corrosive environments
- All form 7 and form 8 covers include gaskets

#### Materials

- Form 7, form 8 and series 35 iron conduit bodies: Sand-cast class 30 gray iron alloy
- Form 9 aluminum: Sand-cast copper-free aluminum alloy
- Stainless steel conduit bodies: Type 316 stainless steel
- Form 7 aluminum: Sand-cast CorroStall™ aluminum alloy
- Covers: Sand-cast gray iron alloy and stamped sheet steel with steel-stainless steel screws
- Stainless steel covers: Stamped type 316 stainless steel with stainless steel screws
- Gaskets: Neoprene
- Aluminum covers: Sand-cast CorroStall aluminum alloy or sheet aluminum with stainless steel screws, aluminum clips and stainless steel and neoprene O-ring washer

#### Finish

- Form 7, form 8 and series 35 iron conduit bodies: Zinc-plating with aluminum acrylic coating
- Form 7 and form 8 iron bodies: Internal PTFE-based BlueKote coating
- Covers: Gray iron zinc-plating with aluminum acrylic coating, and stamped steel zinc-plating with clear chromate coating; form 7 and form 8 covers include neoprene gasket
- Form 9 aluminum covers: Stamped copper-free aluminum sheet with stainless steel screws
- Stainless steel bodies and covers: Polished
- Aluminum bodies and covers: As cast/natural

#### Listings/compliances

- UL Standard: 514A, 514B
- Fed. Spec: W-C-586D
- CSA Standard: C22.2 No. 18

# Conduit bodies and covers

## Quick reference

### Conduit bodies quick reference



Shape	Type	Hub size (in.)									
		½	¾	1	1¼	1½	2	2½	3	3½	4
	<b>LB</b> BlueKote® form 7	LB17	LB27	LB37	LB47	LB57	LB67	LB77	LB87	LB97	LB107
	BlueKote form 8*	LB18	LB28	LB38	LB448	LB58	LB68	LB78	LB888	LB98	LB108
	Series 35	LB50M	LB75M-TB	LB100M	LB125M	LB150M	LB200M	LB250M	LB300M	LB350M	LB400M
	Sand cast aluminum form 7	LB17SA	LB27SA	LB37SA	LB47SA	LB57SA	LB67SA	LB77SA	LB87SA	LB97SA	LB107SA
	Sand cast aluminum form 9	LB19SA	LB29SA	LB39SA	LB49SA	LB59SA	LB69SA	LB789SA	LB889SA	LB989SA	LB1089SA
	Stainless steel form 8**	LB18SST	LB28SST	LB38SST	LB48SST	LB58SST	LB68SST	-	-	-	-
	<b>LU</b> BlueKote form 7	LU17	LU27	LU37	LU47	LU57	LU67	-	-	-	-
	Sand cast aluminum form 7	LU17SA	LU27SA	LU37SA	LU47SA	LU57SA	LU67SA	-	-	-	-
	Sand cast aluminum form 9	LU19SA	LU29SA	LU39SA	LU49SA	LU59SA	LU69SA	-	-	-	-
	Stainless steel form 8**	LU18SST	LU28SST	LU38SST	LU48SST	LU58SST	LU68SST	-	-	-	-
	<b>T</b> BlueKote form 7	T17	T27	T37	T47	T57	T67	T77	T87	T97	T107
	BlueKote form 8*	T18	T28	T38-TB	T448	T58	T68	T78	T88-TB	-	-
	Series 35	T50M	T75M	T100M	T125M	T150M	T200M	T250M	T300M	T350M	T400M
	Sand cast aluminum form 7	T17SA	T27SA	T37SA	T47SA	T57SA	T67SA	T77SA	T87SA	T97SA	T107SA
	Sand cast aluminum form 9	T19SA	T29SA	T39SA	T49SA	T59SA	T69SA	T789SA	T889SA	T989SA	T1089SA
	Stainless steel form 8**	T18SST	T28SST	T38SST	T48SST	T58SST	T68SST	-	-	-	-
	<b>C</b> BlueKote form 7	C17	C27	C37	C47	C57	C67	C77-TB	C87	-	-
	BlueKote form 8*	C18	C28	C38	C448	C58-TB	C68	C78	C88	-	-
	Series 35	C50M	C75M-TB	C100M	C125M	C150M	C200M	C250M-TB	C300M	C350M	C400M
	Sand cast aluminum form 7	C17SA	C27SA	C37SA	C47SA	C57SA	C67SA	-	-	-	-
	Sand cast aluminum form 9	C19SA	C29SA	C39SA	C49SA	C59SA	C69SA	C789SA	C889SA	C989SA	C1089SA
	Stainless steel form 8**	C18SST	C28SST	C38SST	C48SST	C58SST	C68SST	-	-	-	-
	<b>LL</b> BlueKote form 7	LL17	LL27	LL37	LL47	LL57	LL67	LL77	LL87	LL97	LL107
	BlueKote form 8*	LL18	LL28	LL38	LL448	LL58	LL68	LL78	LL888	-	-
	Series 35	LL50M	LL75M	LL100M	LL125M	LL150M	LL200M	LL250M	LL300M	LL350M	LL400M
	Sand cast aluminum form 7	LL17SA	LL27SA	LL37SA	LL47SA	LL57SA	LL67SA	-	-	-	-
	Sand cast aluminum form 9	LL19SA	LL29SA	LL39SA	LL49SA	LL59SA	LL69SA	LL789SA	LL889SA	LL989SA	LL1089SA
	Stainless steel form 8**	LL18SST	LL28SST	LL38SST	LL48SST	LL58SST	LL68SST	-	-	-	-

\* ½" through 1¼" have (2) mounting holes; 1½" through 4" have (4) mounting holes

\*\* With covers, gaskets and screws

# Conduit bodies and covers

## Quick reference

Conduit bodies quick reference (continued)



Shape	Type	Hub size (in.)									
		½	¾	1	1¼	1½	2	2½	3	3½	4
	BlueKote form 7	LR17	LR27	LR37	LR47	LR57	LR67	LR77	LR87	LR97	LR107
	BlueKote form 8*	LR18	LR28	LR38	LR448	LR58	LR68	LR78	LR888	-	-
	Series 35	LR50M	LR75M	LR100M	LR125M	LR150M	LR200M	LR250M	LR300M	LR350M-TB	LR400M
	Sand cast aluminum form 7	LR17SA	LR27SA	LR37SA	LR47SA	LR57SA	LR67SA	-	-	-	-
	Sand cast aluminum form 9	LR19SA	LR29SA	LR39SA	LR49SA	LR59SA	LR69SA	LR789SA	LR889SA	LR989SA	LR1089SA
	BlueKote® form 7	L17-TB	L27-TB	L37-TB	L47-TB	L57-TB	L67-TB	-	-	-	-
	BlueKote form 7	TB17-TB	TB27	TB37	TB47	TB57	TB67	-	-	-	-
	BlueKote form 8*	TB18	TB28	TB38	TB448	TB58	TB68	-	-	-	-
	Series 35	TB50M	TB75M	TB100M	TB125M	TB150M	TB200M	-	-	-	-
	Sand cast aluminum form 7	TB17SA	TB27SA	TB37SA	TB47SA	TB57SA	TB67SA	-	-	-	-
	Sand cast aluminum form 9	TB19SA	TB29SA	TB39SA	TB49SA	TB59SA	TB69SA	-	-	-	-
	Stainless steel form 8**	TB18SST	TB28SST	TB38SST	TB48SST	TB58SST	TB68SST	-	-	-	-
	BlueKote form 7	X17	X27	X37	X47	X57	X67	-	-	-	-
	BlueKote form 8*	X18	X28	X38	X448	X58	X68	-	-	-	-
	Series 35	X50M	X75M	X100M	X125M	X150M	X200M	-	-	-	-
	Sand cast aluminum form 7	X17SA	X27SA	X37SA	X47SA	X57SA	X67SA	-	-	-	-
	Sand cast aluminum form 9	X19SA	X29SA	X39SA	-	-	-	-	-	-	-
	BlueKote form 7	E17	E27	E37	-	-	-	-	-	-	-
	BlueKote form 7	TA17	TA27	TA37	TA47	TA57	TA67	-	-	-	-

\* ½" through 1¼" have (2) mounting holes; 1½" through 4" have (4) mounting holes  
 \*\* With covers, gaskets and screws

# Conduit bodies and covers

## Covers and gaskets

### Replacement covers and gaskets

		Hub size (in.)									
Shape		½	¾	1	1¼	1½	2	2½	3	3½	4
	Form 7 steel*	170S	270S	370S	470S	570S	670S	870S	870S	970S	970S
	Form 8 steel*	180	280	380	480	580	680STB	880	880	980	980
	Form 7 aluminum*	170SA	270SA	370SA	470SA	570SA	670SA	870SA	870SA	970SA	970SA
	Form 9 aluminum	190SA**	290SA**	390SA**	490SA**	590SA**	690SA**	889SA	889SA	989SA	989SA
	Series 35	K50S	K75S	K100S	K125S	K125S	K200S	K250S	K250S	K350S	K350S
	Form 8 stainless Steel	180SST	280SST	380SST	480SST	580SST	680SST	-	-	-	-

\* Form 7 and Form 8 covers include gasket.

\*\* For Form 9 aluminum cover including gasket, replace suffix SA with GSA (Example : 190GSA)

		Hub size (in.)									
Shape		½	¾	1	1¼	1½	2	2½	3	3½	4
	Form 7 iron*	170F	270F	370F	470F	570F	670F	870F	870F	970F	970F
	Form 8 iron*	180F	280F	380F	480F	580F	680F	880F	880F	980F	980F
	Form 7 aluminum*	170FSA	270FSA	370FSA	470FSA	570FSA	670FSA	870FSA	870FSA	970FSA	970FSA
	Series 35	K50M	K75M	K100M	K125M	K125M	K200M	K250M	K250M	K350M	K350M

\* Form 7 and Form 8 covers include gasket.

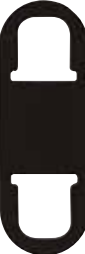
		Hub size (in.)									
Shape		½	¾	1	1¼	1½	2	2½	3	3½	4
	Form 7*	GASK571	GASK572	GASK573	GASK574	GASK575	GASK576	GASK578	GASK578	GASK579	GASK579
	Form 8*	GASK581N	GASK582N	GASK583N	GASK584N	GASK585N	GASK586N	GASK588N	GASK588N	GASK589N	GASK589N
	Form 9*	GASK1941	GASK1942	GASK1943	GASK1944	GASK1945	GASK1946	GASK808N	GASK808N	GASK809N	GASK809N
	Series 35	GK50N	GK75N	GK100N	GK125-150N	GK125-150N	GK200N	GK250-300N	GK250-300N	GK350-400N	GK350-400N

\* For ordering purposes, please use GASK in the catalog number (Example: GASK 571).

## Conduit bodies and covers

### Type 316 stainless steel form 8

Each conduit outlet body ships complete with gasket, cover and screws.



LU Form 8 conduit bodies with covers



Cat. no.	Hub size (in.)	Dimensions (in.)							Cu. in.
		A	B	C	D	E	F		
LU18SST	1/2	6.210	1.450	3.825	1.125	4.320	3.700	5.5	
LU28SST	3/4	6.981	1.645	4.245	1.500	4.921	4.300	8.5	
LU38SST	1	8.261	1.850	5.050	1.700	5.625	5.000	14.5	
LU48SST	1 1/4	9.923	2.200	5.975	2.200	6.730	5.810	26.5	
LU58SST	1 1/2	11.549	2.813	7.000	2.450	7.938	7.125	45.0	
LU68SST	2	13.989	3.820	8.500	2.900	9.797	9.125	116.5	

Diagrams

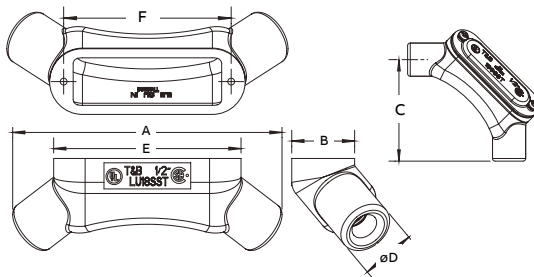

T Form 8 conduit bodies with covers



Cat. no.	Hub size (in.)	Dimensions (in.)							Cu. in.
		A	B	C	D	E	F		
T18SST	1/2	5.820	1.450	2.200	1.150	4.320	3.700	5.5	
T28SST	3/4	6.420	1.645	2.395	1.400	4.921	4.300	9.0	
T38SST	1	7.500	1.850	2.850	1.750	5.625	5.000	13.5	
T48SST	1 1/4	8.738	2.200	2.950	2.200	6.730	5.810	24.0	
T58SST	1 1/2	10.046	2.813	3.867	2.450	7.938	7.125	45.0	
T68SST	2	12.204	3.820	5.070	2.900	9.797	9.125	88.0	
T78SST	2.5	15.659	4.575	6.561	4.250	10.875	-	220	
T888SST	3	15.817	4.575	6.640	4.250	10.875	-	220	
T108SST	4	18.473	5.535	8.037	5.513	13.462	-	420	

Diagrams

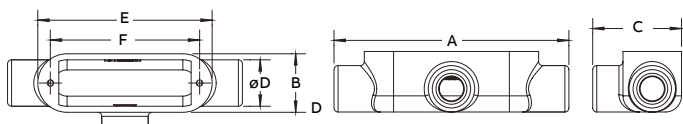

LB Form 8 conduit bodies with covers



Cat. no.	Hub size (in.)	Dimensions (in.)							Cu. in.
		A	B	C	D	E	F		
LB18SST	1/2	5.070	1.450	2.250	1.150	4.320	3.700	5.8	
LB28SST	3/4	5.671	1.645	2.530	1.400	4.921	4.300	8.0	
LB38SST	1	6.563	1.850	2.913	1.750	5.625	5.000	13.0	
LB48SST	1 1/4	7.734	2.200	3.315	2.200	6.730	5.810	23.0	
LB58SST	1 1/2	8.992	2.813	3.800	2.450	7.938	7.125	44.0	
LB68SST	2	11.000	3.820	4.810	2.900	9.797	9.125	88.0	
LB78SST	2 1/2	14.098	6.136	5.000	4.250	10.875	-	220	
LB888SST	3	14.177	6.215	5.000	4.250	10.875	-	220	
LB108SST	4	16.749	7.259	6.313	5.513	13.462	-	420	

Diagrams

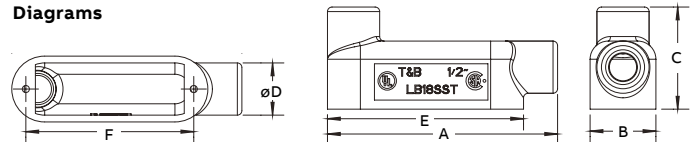

TB Form 8 conduit bodies with covers



Cat. no.	Hub size (in.)	Dimensions (in.)							Cu. in.
		A	B	C	D	E	F		
TB18SST	1/2	5.820	1.450	2.250	1.150	4.320	3.700	5.5	
TB28SST	3/4	6.420	1.645	2.530	1.400	4.921	4.300	9.0	
TB38SST	1	7.500	1.850	2.975	1.750	5.625	5.000	13.5	
TB48SST	1 1/4	8.484	2.200	3.319	2.200	6.730	5.810	24.0	
TB58SST	1 1/2	10.046	2.813	3.854	2.450	7.938	7.125	45.0	
TB68SST	2	12.129	3.820	4.810	2.900	9.797	9.125	88.0	

Diagrams

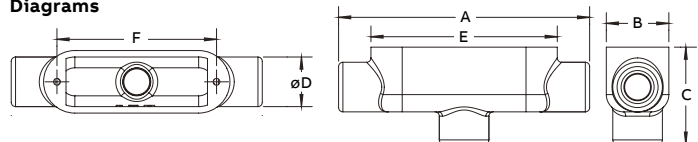

## Conduit bodies and covers

### Pre-assembled form 7 BlueKote®

#### Pre-assembled form 7 BlueKote conduit bodies

Form 7 body, gasket and cover – one number. Now you can order a conduit body, gasket and cover, pre-assembled, using one catalog number. ABB's pre-assembled cast conduit bodies help reduce transactions, eliminate the need for additional stocking bins and provide an easy inventory reduction. You'll also have less hassle with managing small parts in the truck or crib. Best of all, you can be absolutely confident that the right parts are in your hands when you need them.

#### T&B® Fittings conduit bodies and covers feature:

- BlueKote internal finish for faster, easier wire pulling
- Epoxy external finish for superior corrosion resistance
- Tapered NPT threads and integral bushings to protect wire insulation
- Bodies are designed with a flat back for more cubic inch capacity; the flat back also keeps the body more stable during installation, requiring fewer conduit straps
- T&B Fittings form 7 bodies and covers are interchangeable with Crouse-Hinds and Appleton's form 7 bodies and covers

#### Specifications

- Bodies: Class 30 gray iron alloy
- Covers: Stamped steel with stainless steel screws
- Gaskets: Neoprene
- Finish: Conduit bodies: zinc-plating with acrylic epoxy coating and internal
- PTFE-based BlueKote coating
- Covers: Stamped steel zinc-plating with a clear chromate coating
- Compliances: UL Standard: 514A, 514B Fed. Spec: W-C-586D
- CSA Standard: C22.2 No. 18

Crouse-Hinds is a trademark of Cooper Industries, Inc. Appleton is a trademark of the EGS Electrical Group, a joint venture of Emerson and SPX Corp.

Note: BlueKote is registered for conduit bodies but is not registered for a finish or a coating.

#### T&B Fittings pre-assembled conduit bodies, gaskets and covers



Cat. no.	Trade size (in.)	Pre-assembled products
C17CG-TB	1/2	C17 body, cover and gasket
C27CG-TB	3/4	C27 body, cover and gasket
C37CG-TB	1	C37 body, cover and gasket
C47CG-TB	1 1/4	C47 body, cover and gasket
C57CG-TB	1 1/2	C57 body, cover and gasket
C67CG-TB	2	C67 body, cover and gasket
LB17CG-TB	1/2	LB17 body, cover and gasket
LB27CG-TB	3/4	LB27 body, cover and gasket
LB37CG-TB	1	LB37 body, cover and gasket
LB47CG-TB	1 1/4	LB47 body, cover and gasket
LB57CG-TB	1 1/2	LB57 body, cover and gasket
LB67CG-TB	2	LB67 body, cover and gasket
LL17CG-TB	1/2	LL17 body, cover and gasket
LL27CG-TB	3/4	LL27 body, cover and gasket
LL37CG-TB	1	LL37 body, cover and gasket
LL47CG-TB	1 1/4	LL47 body, cover and gasket
LL57CG-TB	1 1/2	LL57 body, cover and gasket
LL67CG-TB	2	LL67 body, cover and gasket
LR17CG-TB	1/2	LR17 body, cover and gasket
LR27CG-TB	3/4	LR27 body, cover and gasket
LR37CG-TB	1	LR37 body, cover and gasket
LR47CG-TB	1 1/4	LR47 body, cover and gasket
LR57CG-TB	1 1/2	LR57 body, cover and gasket
LR67CG-TB	2	LR67 body, cover and gasket
T17CG-TB	1/2	T17 body, cover and gasket
T27CG-TB	3/4	T27 body, cover and gasket
T37CG-TB	1	T37 body, cover and gasket
T47CG-TB	1 1/4	T47 body, cover and gasket
T57CG-TB	1 1/2	T57 body, cover and gasket
T67CG-TB	2	T67 body, cover and gasket
TB17CG-TB	1/2	TB17 body, cover and gasket
TB27CG-TB	3/4	TB27 body, cover and gasket
TB37CG-TB	1	TB37 body, cover and gasket
TB47CG-TB	1 1/4	TB47 body, cover and gasket
TB57CG-TB	1 1/2	TB57 body, cover and gasket
TB67CG-TB	2	TB67 body, cover and gasket
X17CG-TB	1/2	X17 body, cover and gasket
X27CG-TB	3/4	X27 body, cover and gasket
X37CG-TB	1	X37 body, cover and gasket
X47CG-TB	1 1/4	X47 body, cover and gasket
X57CG-TB	1 1/2	X57 body, cover and gasket
X67CG-TB	2	X67 body, cover and gasket

For aluminum conduit bodies pre-assembled with covers and gaskets, request Red•Dot® D-PAK® series conduit bodies for rigid and IMC conduit.



## Conduit bodies and covers

### Sand cast aluminum form 7



LB Sand cast aluminum form 7 conduit bodies



Cat. no.	Hub size (in.)	Dimensions (in.)						Cu. in.
		A	B	C	D	E		
LB17SA	1/2	4.63	2.19	1.41	1.03	3.19	4.2	
LB27SA	3/4	5.25	2.47	1.59	1.22	3.81	6.8	
LB37SA	1	6.22	2.88	1.75	1.38	4.56	11.0	
LB47SA	1 1/4	6.59	3.34	2.19	1.81	5.03	19.5	
LB57SA	1 1/2	6.97	3.59	2.44	2.06	5.44	25.6	
LB67SA	2	8.13	4.25	3.06	2.44	6.41	51.2	
LB77SA	2 1/2	10.56	5.19	4.25	3.63	8.38	100.4	
LB87SA	3	10.66	6.03	4.25	3.63	8.38	126.2	
LB97SA	3 1/2	11.06	6.69	5.25	4.44	10.25	219.0	
LB107SA	4	12.81	7.72	5.25	4.44	10.25	247.1	

Diagrams

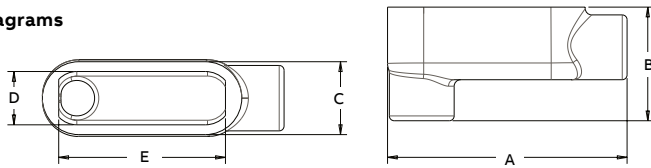

LR Sand cast aluminum form 7 conduit bodies



Cat. no.	Hub size (in.)	Dimensions (in.)						Cu. in.
		A	B	C	D	E		
LR17SA	1/2	4.38	1.41	2.25	1.03	3.19	4.5	
LR27SA	3/4	5.31	1.63	2.44	1.19	3.81	7.5	
LR37SA	1	6.22	1.88	2.78	1.38	4.56	11.2	
LR47SA	1 1/4	6.63	2.31	3.22	1.81	5.03	20.3	
LR57SA	1 1/2	6.97	2.56	3.47	2.06	5.44	27.8	
LR67SA	2	8.13	3.19	4.13	2.44	6.25	54.0	

Diagrams

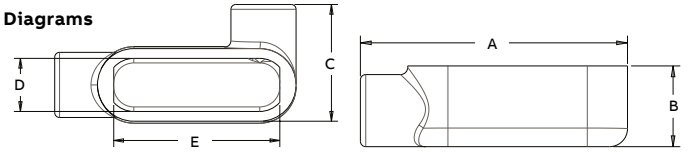

LL Sand cast aluminum form 7 conduit bodies



Cat. no.	Hub size (in.)	Dimensions (in.)						Cu. in.
		A	B	C	D	E		
LL17SA	1/2	4.38	1.41	2.25	1.03	3.19	4.5	
LL27SA	3/4	5.31	1.63	2.44	1.19	3.81	7.2	
LL37SA	1	6.22	1.88	2.78	1.38	4.56	11.5	
LL47SA	1 1/4	6.63	2.31	3.22	1.81	5.03	20.0	
LL57SA	1 1/2	6.97	2.56	3.47	2.06	5.44	28.0	
LL67SA	2	8.13	3.19	4.13	2.44	6.25	54.2	

Diagrams

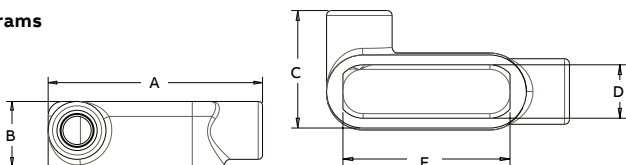

C Sand cast aluminum form 7 conduit bodies



Cat. no.	Hub size (in.)	Dimensions (in.)						Cu. in.
		A	B	C	D	E		
C17SA	1/2	5.44	1.41	1.41	1.00	3.19	4.8	
C27SA	3/4	6.16	1.63	1.59	1.22	3.81	7.5	
C37SA	1	7.22	1.88	1.75	1.38	4.56	11.8	
C47SA	1 1/4	7.63	2.31	2.19	1.91	5.03	19.8	
C57SA	1 1/2	8.00	2.56	2.44	2.06	5.44	27.8	
C67SA	2	9.16	3.22	3.06	2.44	6.25	53.2	

Diagrams

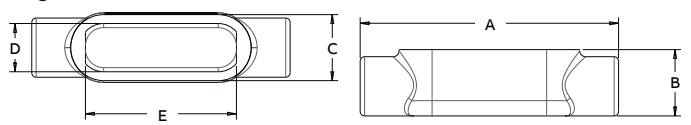



## Conduit bodies and covers

### Sand cast aluminum form 7



LU® Sand cast aluminum form 7 conduit bodies



Cat. no.	Hub size (in.)	Dimensions (in.)						Cu. in.
		A	B	C	D	E	F	
LU17SA	1/2	5.53	1.50	2.88	1.03	3.19	3.31	5.1
LU27SA	3/4	6.28	1.72	3.22	1.22	3.81	3.75	8.7
LU37SA	1	7.34	1.97	3.78	1.38	4.56	4.41	13.4
LU47SA	1 1/4	8.38	2.47	4.34	1.81	5.03	4.91	23.8
LU57SA	1 1/2	8.97	2.72	4.53	2.06	5.44	5.19	29.6
LU67SA	2	10.78	3.44	5.41	2.44	6.25	6.25	59.4

Diagrams

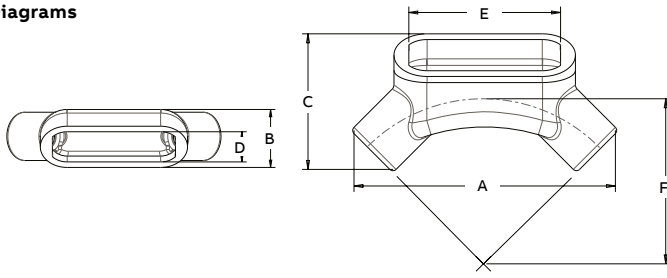

T Sand cast aluminum form 7 conduit bodies



Cat. no.	Hub size (in.)	Dimensions (in.)					Cu. in.
		A	B	C	D	E	
T17SA	1/2	5.44	1.78	2.28	1.03	3.19	5.5
T27SA	3/4	6.16	2.00	2.59	1.22	3.81	9.1
T37SA	1	7.22	2.28	3.22	1.38	4.56	15.5
T47SA	1 1/4	7.63	2.31	3.22	1.81	5.03	20.1
T57SA	1 1/2	8.00	2.56	3.47	2.06	5.44	27.1
T67SA	2	9.16	3.19	4.09	2.44	6.41	51.0
T77SA	2 1/2	12.13	3.63	5.81	3.63	8.38	104.6
T87SA	3	12.28	4.41	5.91	3.63	8.38	135.2
T97SA	3 1/2	14.44	4.91	6.94	4.44	10.25	230.0
T107SA	4	14.50	5.41	6.97	4.44	10.25	260.3

Diagrams

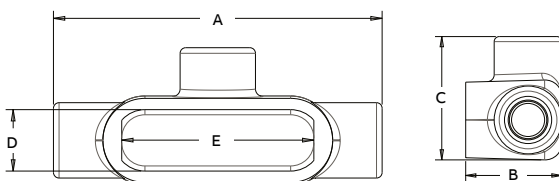

TB Sand cast aluminum form 7 conduit bodies



Cat. no.	Hub size (in.)	Dimensions (in.)					Cu. in.
		A	B	C	D	E	
TB17SA	1/2	5.44	2.59	1.50	1.03	3.19	5.6
TB27SA	3/4	6.16	2.84	1.66	1.19	3.81	9.0
TB37SA	1	7.22	3.28	1.78	1.38	4.56	13.1
TB47SA	1 1/4	7.63	3.34	2.19	1.81	5.03	19.3
TB57SA	1 1/2	8.00	3.59	2.44	2.06	5.44	25.0
TB67SA	2	9.16	4.25	3.06	2.44	6.41	51.6

Diagrams

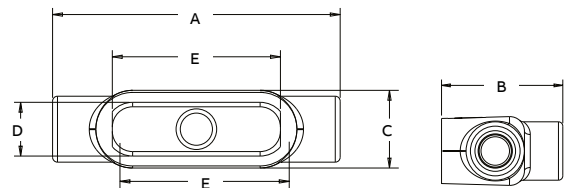

X Sand cast aluminum form 7 conduit bodies



Cat. no.	Hub size (in.)	Dimensions (in.)					Cu. in.
		A	B	C	D	E	
X17SA	1/2	5.44	3.06	1.78	1.03	3.19	5.8
X27SA	3/4	6.16	3.44	2.00	1.22	3.81	10.3
X37SA	1	7.22	4.22	2.28	1.38	4.56	16.4
X47SA	1 1/4	7.63	4.25	2.31	1.81	5.03	21.3
X57SA	1 1/2	8.00	4.50	2.56	2.06	5.44	28.6
X67SA	2	9.16	5.16	3.19	2.44	6.41	53.5

Diagrams

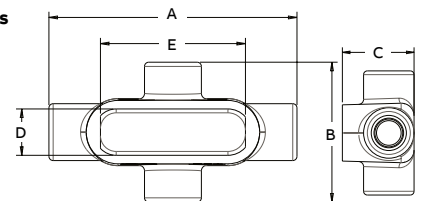

## Conduit bodies and covers

### Sand cast aluminum form 9



C Sand cast aluminum form 9 conduit bodies



Cat. no.	Hub size (in.)	Dimensions (in.)						Cu. in.
		A	B	C	D	E		
C19SA	½"	5.858	1.5	1.392	1.018	3.307	4.5	
C29SA	¾"	6.48	1.78	1.56	1.186	3.898	7.5	
C39SA	1"	7.578	1.975	1.756	1.382	4.559	11.5	
C49SA	1¼"	8.593	2.315	2.2	1.826	5.197	22.3	
C59SA	1½"	9.238	2.8	2.5	1.788	5.892	34	
C69SA	2"	11.578	3.56	3.189	2.349	8.11	80.0	
C789SA	2½"	15.522	4.575	5.04	4.29	10.827	212	
C889SA	3"	15.68	4.575	5.04	4.29	10.827	216	
C989SA	3½"	18.452	5.535	6.338	5.538	13.438	408	
C1089SA	4"	18.498	5.535	6.339	5.538	13.438	440	

Diagrams

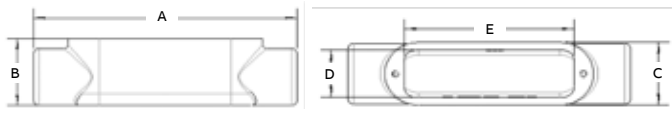

LB Sand cast aluminum form 9 conduit bodies



Cat. no.	Hub size (in.)	Dimensions (in.)						Cu. in.
		A	B	C	D	E		
LB19SA	½"	5.034	2.231	1.392	1.018	3.307	4.5	
LB29SA	¾"	5.64	2.62	1.56	1.186	3.898	7.5	
LB39SA	1"	6.569	2.984	1.756	1.382	4.55	11.5	
LB49SA	1¼"	7.767	3.344	2.2	1.826	5.197	22.3	
LB59SA	1½"	8.209	3.829	2.5	2.1	5.906	34	
LB69SA	2"	10.533	4.605	3.228	2.388	7.941	80.0	
LB789SA	2½"	13.961	6.011	5.04	4.29	10.827	212	
LB889SA	3"	14.04	6.215	5.04	4.29	10.827	216	
LB989SA	3½"	16.751	7.236	6.339	5.576	13.437	408	
LB1089SA	4"	16.774	7.259	6.339	5.573	13.438	440	

Diagrams

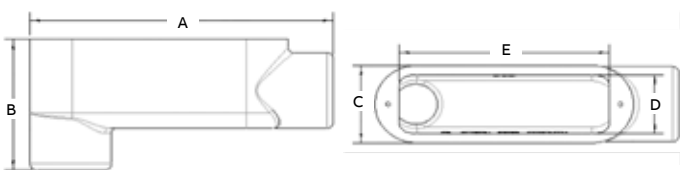

LL Sand cast aluminum form 9 conduit bodies



Cat. no.	Hub size (in.)	Dimensions (in.)						Cu. in.
		A	B	C	D	E		
LL19SA	½"	5.034	1.5	2.213	1.018	3.28	4.5	
LL29SA	¾"	5.64	1.78	2.4	1.186	3.898	7.5	
LL39SA	1"	6.569	1.975	2.765	1.382	4.55	11.5	
LL49SA	1¼"	7.564	2.315	3.229	1.826	5.197	22.3	
LL59SA	1½"	8.591	2.8	3.529	2.126	5.906	34	
LL69SA	2"	10.714	3.56	4.234	2.349	8.11	80.0	
LL789SA	2½"	13.961	4.575	6.601	4.29	10.827	212	
LL889SA	3"	14.04	4.575	6.68	4.29	10.827	216	
LL989SA	3½"	16.563	5.535	8.04	5.577	13.437	408	
LL1089SA	4"	16.774	5.535	8.063	5.577	13.438	440	

Diagrams

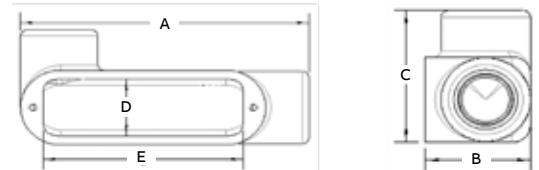

LR Sand cast aluminum form 9 conduit bodies



Cat. no.	Hub size (in.)	Dimensions (in.)						Cu. in.
		A	B	C	D	E		
LR19SA	½"	5.034	1.5	2.213	1.018	3.28	4.5	
LR29SA	¾"	5.64	1.78	2.4	1.186	3.898	7.5	
LR39SA	1"	6.569	1.975	2.765	1.382	4.55	11.5	
LR49SA	1¼"	7.564	2.315	3.229	1.826	5.197	22.3	
LR59SA	1½"	8.591	2.8	3.529	2.126	5.906	34	
LR69SA	2"	10.714	3.56	4.234	2.349	8.11	80.0	
LR789SA	2½"	13.961	4.575	6.601	4.29	10.827	212	
LR889SA	3"	14.04	4.575	6.68	4.29	10.827	216	
LR989SA	3½"	16.563	5.535	8.04	5.577	13.437	408	
LR1089SA	4"	16.774	5.535	8.063	5.577	13.438	440	

Diagrams

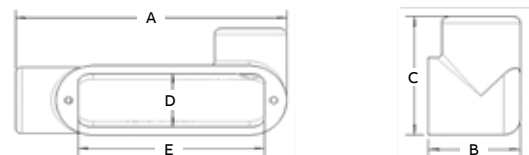

## Conduit bodies and covers

### Form 9 sand cast aluminum



LU Sand cast aluminum form 9 conduit bodies



Cat. no.	Hub size (in.)	Dimensions (in.)						Cu. in.
		A	B	C	D	E	Radius	
LU19SA	½	6.21	2.701	1.5	1.018	3.28	4.415	5.3
LU29SA	¾	6.97	3.047	1.698	1.186	3.898	4.92	8.0
LU39SA	1	8.276	3.651	2.02	1.445	4.559	6.143	14.0
LU49SA	1¼	9.902	4.266	2.362	1.826	5.29	7.666	30.8
LU59SA	1½	10.256	5.127	2.609	2.126	5.906	8.214	41.0
LU69SA	2	13.968	6.153	3.421	2.815	7.941	8.5	97.0

Diagrams

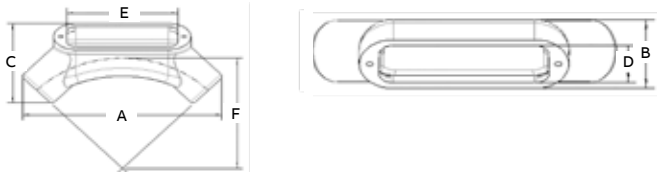

T Sand cast aluminum form 9 conduit bodies



Cat. no.	Hub size (in.)	Dimensions (in.)						Cu. in.
		A	B	C	D	E		
T19SA	½	5.958	1.775	2.393	1.078	3.307	6.3	
T29SA	¾	6.455	2	2.591	1.185	3.925	9.3	
T39SA	1	7.578	2.275	2.765	1.382	4.559	14.0	
T49SA	1¼	8.593	2.315	3.229	1.826	5.197	22.0	
T59SA	1½	9.243	2.8	3.529	2.126	5.906	34.8	
T69SA	2	11.578	3.56	4.234	2.815	8.11	80.5	
T789SA	2½	15.522	4.575	6.601	4.25	10.827	175	
T889SA	3	15.68	4.575	6.68	4.25	10.827	236	
T989SA	3½	18.452	5.535	8.04	5.539	13.437	435	
T1089SA	4	18.498	5.535	8.063	5.539	13.438	450	

Diagrams

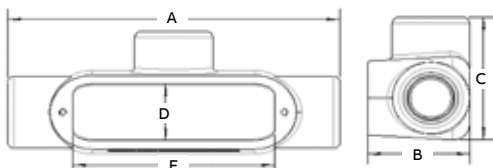

TB Sand cast aluminum form 9 conduit bodies



Cat. no.	Hub size (in.)	Dimensions (in.)						Cu. in.
		A	B	C	D	E		
TB19SA	½	5.958	2.596	1.556	1.018	3.307	6.3	
TB29SA	¾	6.6	2.84	1.715	1.186	3.898	9.3	
TB39SA	1	7.644	3.284	1.756	1.382	4.559	14.0	
TB49SA	1¼	8.788	3.344	2.2	1.826	5.197	22.0	
TB59SA	1½	9.996	3.604	2.5	1.784	5.883	34.8	
TB69SA	2	11.578	4.605	3.189	2.815	8.11	80.5	

Diagrams

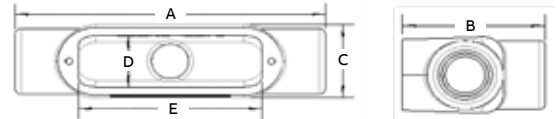

X Sand cast aluminum form 9 conduit bodies



Cat. no.	Hub size (in.)	Dimensions (in.)						Cu. in.
		A	B	C	D	E		
X19SA	½	5.958	1.775	3.094	1.018	3.28	6.3	
X29SA	¾	6.61	2	3.37	1.186	3.898	9.3	
X39SA	1	7.578	2.275	3.774	1.382	4.559	14.0	

Diagrams

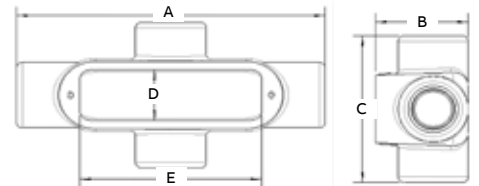

# Rigid and intermediate metal conduit fittings

## Methods of bonding and grounding

- (1) Threaded or threadless rigid metal conduit or intermediate metal conduit
- (2) Series 8123 or 8124 threadless fittings
- (3) Series 8125 set screw fitting
- (4) Series 370 or H050-TB sealing hub (Bullet Hubs)
- (5) Series 140 locknuts
- (6) Series 106 bonding locknut
- (7) Series 3870 bonding & grounding bushing
- (8) Sta-Kon® or Color-Keyed® lug

**Case 1:** Where threaded or threadless conduit terminates into a threadless opening in a sheet metal box or enclosure with or without concentric or eccentric knockouts.

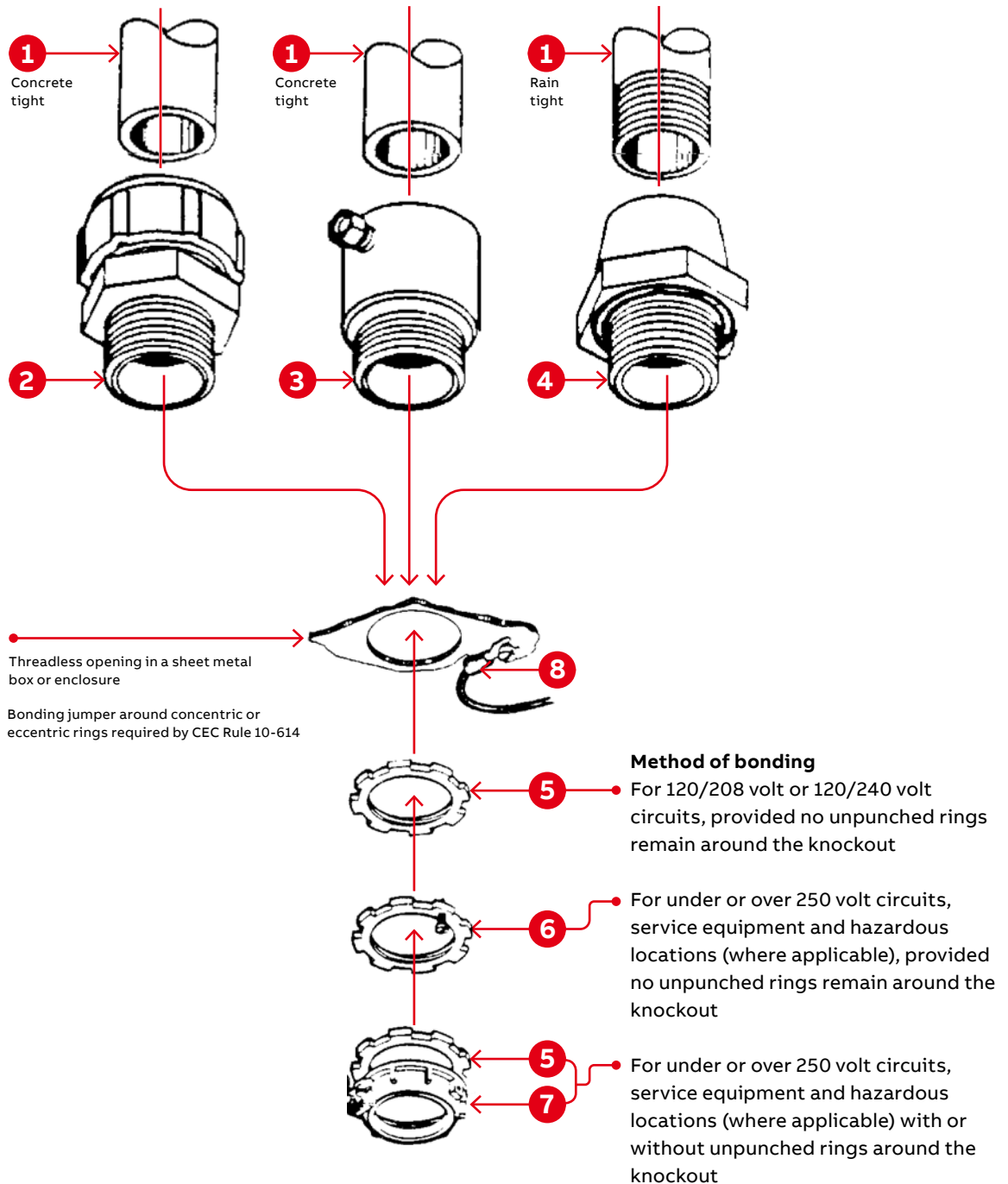

## Rigid and intermediate metal conduit fittings

### Methods of bonding and grounding

(1) Threaded or threadless rigid metal conduit or intermediate metal conduit  
 (2) Series 8123 threadless fitting  
 (3) Series 8125 set screw fitting

**Case 2:** Where threaded or threadless conduit terminates into a threaded hub in a cast metal enclosure.

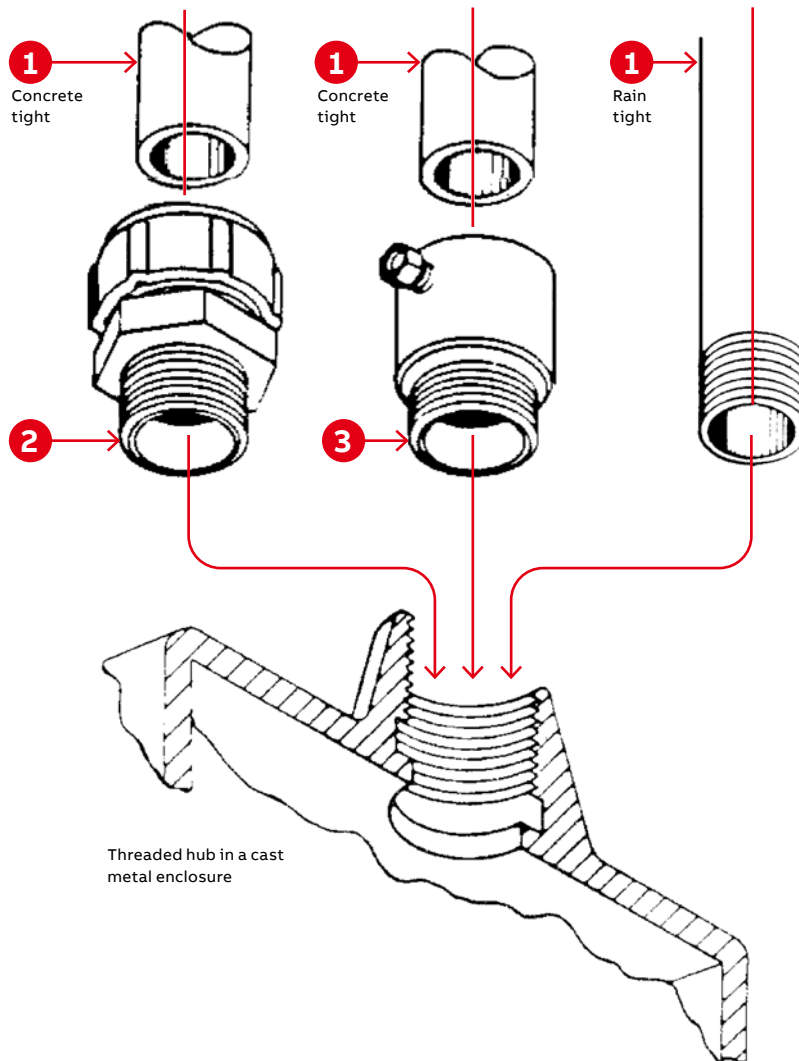

#### Methods of bonding

For:

- (1) 120/208 or 120/240 volt circuits (CEC 10-610)
- (2) Over 250 volt circuits (CEC 10-610)
- (3) Service equipment (CEC 10-604)

- (4) Hazardous locations 18-074 (where applicable)
  - 18-124 (Class I, Zone 1)
  - 18-160 (Class I, Zone 2)
  - 18-218 (Class II, Division 1)
  - 18-268 (Class II, Division 2)
  - 18-316 (Class III, Division 1)
  - 18-366 (Class III, Division 2)

## Rigid and intermediate metal conduit fittings

### Methods of bonding and grounding

- (1) Threaded rigid metal conduit or intermediate metal conduit
- (2) Series 142 locknuts
- (3) Series 122 bushing metallic
- (4) Series 222 bushing plastic
- (5) Series 106 bonding locknut
- (6) Series 3650 bonding wedge

**Case 3:** Where threaded conduit terminates into a threadless opening in a sheet metal box or enclosure with no concentric or eccentric rings remaining around knockout.

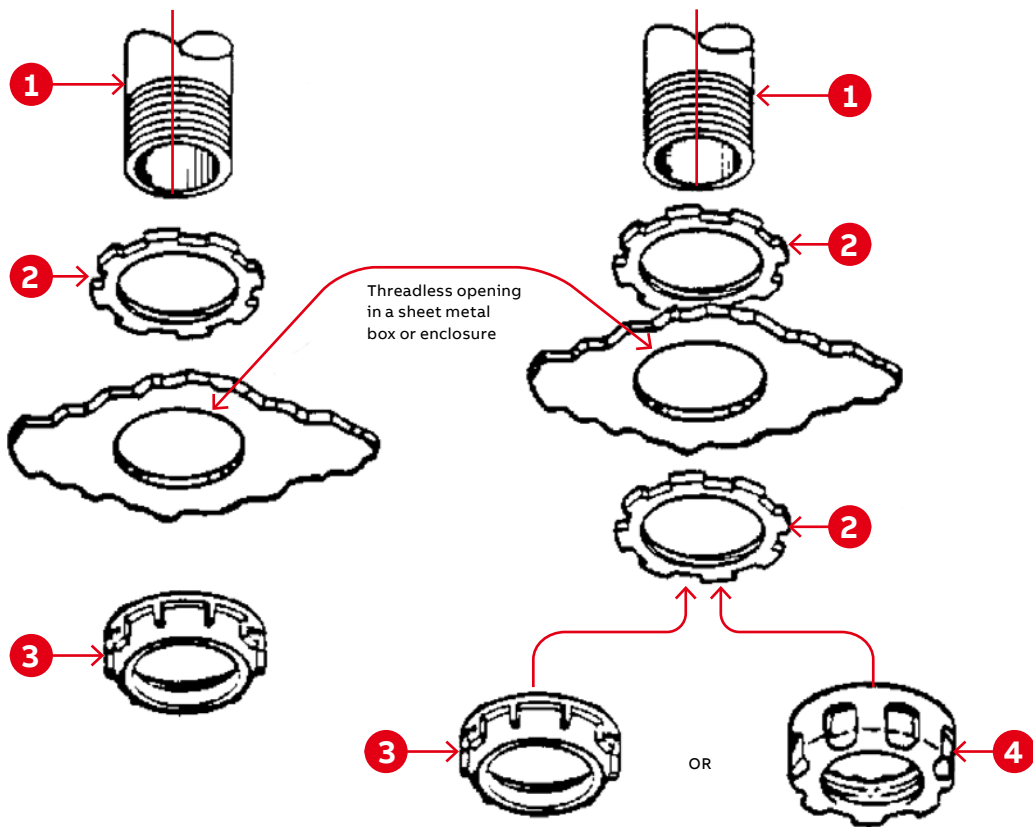

**Method of bonding** for 120/208 volt or 120/240 volt circuits (other than service equipment).

**Method of bonding** for over 250 volt circuits, e.g. 600/347 volt systems and those operating over 600 volts (other than service equipment).

Note: Any of the bonding methods described for service equipment may also be used.

## Rigid and intermediate metal conduit fittings

### Methods of bonding and grounding

- (1) Threaded rigid metal conduit or intermediate metal conduit
- (2) Series 142 locknuts
- (3) Series 122 bushing metallic
- (4) Series 222 bushing plastic
- (5) Series 106 bonding locknut
- (6) Series 3650 bonding wedge

**Case 3 (cont'd):** Where threaded conduit terminates into a threadless opening in a sheet metal box or enclosure with no concentric or eccentric rings remaining around knockout.

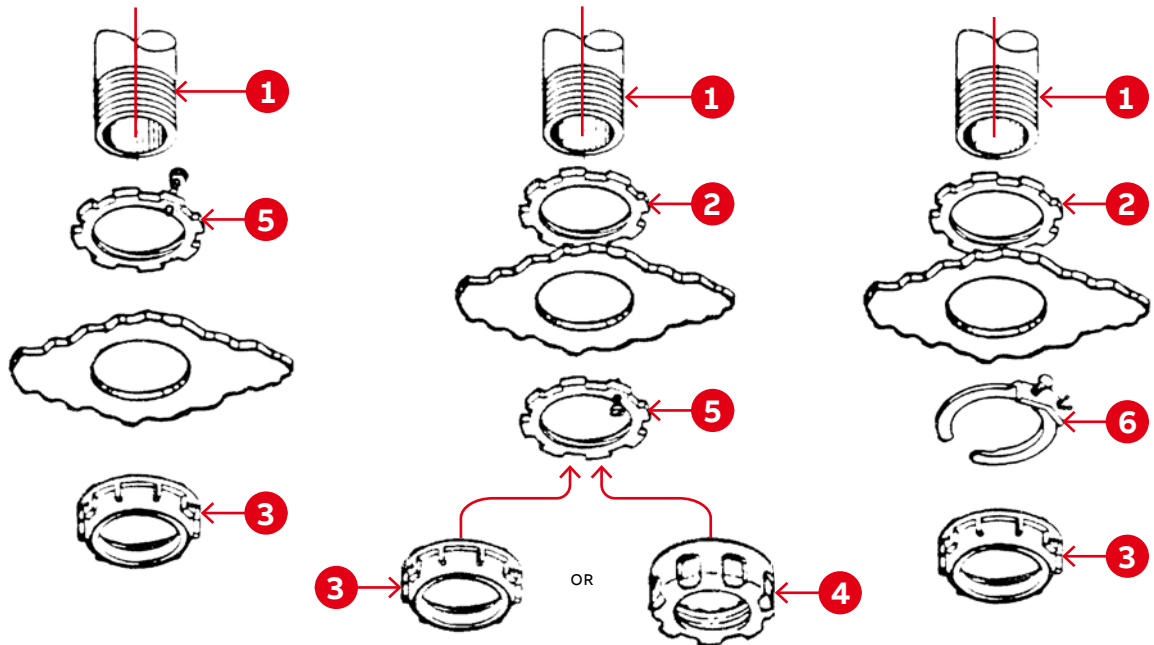

#### Methods of bonding

For:

- (i) Over 250 volt circuit, e.g. 347/600-volt systems and those operating over 600 volts
- (ii) Service equipment
- (iii) Hazardous locations where applicable

## Rigid and intermediate metal conduit fittings

### Methods of bonding and grounding

- (1) Threaded rigid metal conduit or intermediate metal conduit
- (2) Series 142 locknuts
- (3) Series 122 bushing, metallic
- (4) Series 3650 bonding wedge
- (5) Series 3870 bonding and grounding bushing
- (6) Typical mechanical or pressure type fitting

**Case 4:** Where threaded conduit terminates into a threadless opening in a sheet metal box or enclosure with concentric or eccentric rings remaining around knockout.

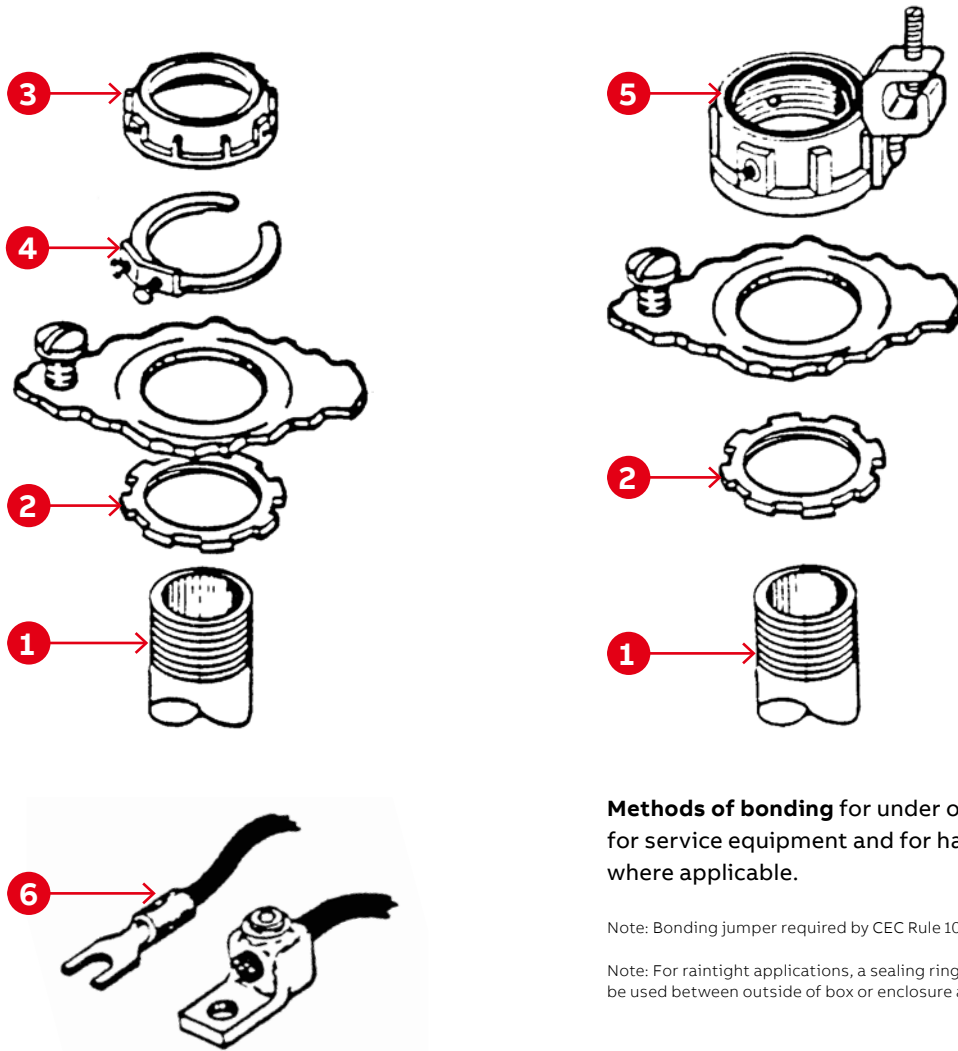

**Methods of bonding** for under or over 250 volts, for service equipment and for hazardous locations where applicable.

Note: Bonding jumper required by CEC Rule 10-614

Note: For raintight applications, a sealing ring, ABB series 5302, may be used between outside of box or enclosure and the outside locknut.



# Rigid and intermediate metal conduit fittings

## Methods of bonding and grounding

- 1 Series 142 locknut
- 2 Series 3870 bonding and grounding bushing (threaded)
- 3 Series 5262 sealing O-ring
- 4 Typical bolted or pressure lug
- 
- 01 Bonding service equipment (CEC Rule 10-604)
- 
- 02 Multiple bonding of service raceways where service entrance conductors are paralleled in two or more raceways, CEC Rule 10-614
- 
- 03 Install bonding jumper to assure electrical continuity between isolated sections of raceways (CEC Rule 10-614)

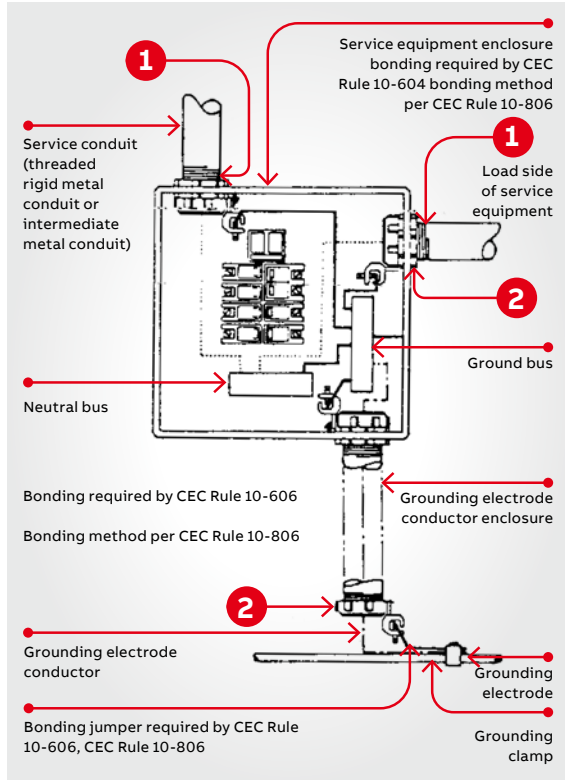

01

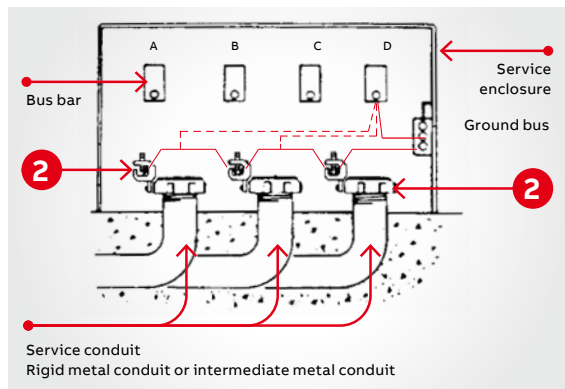

02

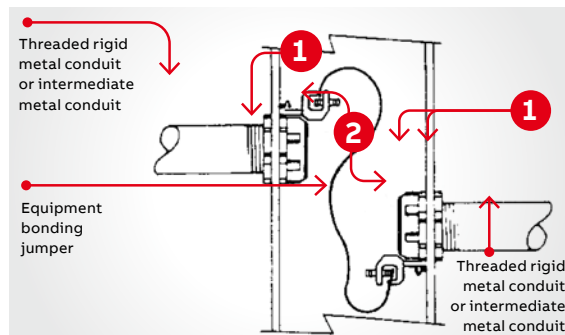

03

### Suggested specifications

#### Insulated grounding and bonding bushing (series 3870)

Where code requires bonding and grounding of single or multiple metal conduit, or positive bonding and grounding of metal conduit to the box, enclosure or auxiliary gutter, the end of the conduit shall be equipped with an insulated metallic grounding and bonding bushing such as series 3870 manufactured by ABB.

#### Grounding and bonding bushings used shall be approved for the purpose and:

- (1) Shall be of malleable iron/steel/aluminum construction adequately protected against corrosion.
- (2) Bushing insulator shall be listed or certified for 150 °C/302 °F application with a flammability rating of 94V-0. Insulator must be positively locked in place.

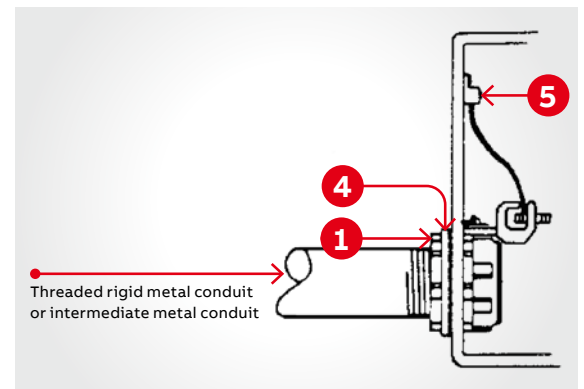

- (i) Installing bonding jumper around unpunched concentric or eccentric knockouts in sheet metal box or enclosure (CEC Rule 10-806)
- (ii) Installing bonding jumper in hazardous locations where 'locknut bushing' or 'double locknut' type of contact is unacceptable method for bonding purposes (CEC Rule 18-074)

# Rigid and intermediate metal conduit fittings

## Methods of bonding and grounding

- (1) Series 142 Locknut
- (2) Series 106 bonding locknuts
- (3) Series 122 bushing

### Suitable for bonding raceway, EMT or terminating fitting to a sheet metal box or enclosure where

- (a) No unpunched concentric or eccentric rings remain around the knockout
- (b) Ordinary locknut is unacceptable for bonding purposes such as:
  - (i) Service equipment enclosures CEC Rule 10-614
  - (ii) Bonding for circuits over 250 volts (where required) CEC Rule 10-614
  - (iii) Bonding in hazardous locations regardless of the voltage of the system CEC Rule 18-074

### Suggested specifications

#### Bonding type locknut (series 106)

Where drawings indicate installation of a bonding type locknut to effectively bond a terminating fitting or metal conduit to a cabinet, box, enclosure or an auxiliary gutter, the locknuts installed shall be of hardened steel/malleable iron construction, electro-zinc plated, such as series 106 manufactured by ABB.

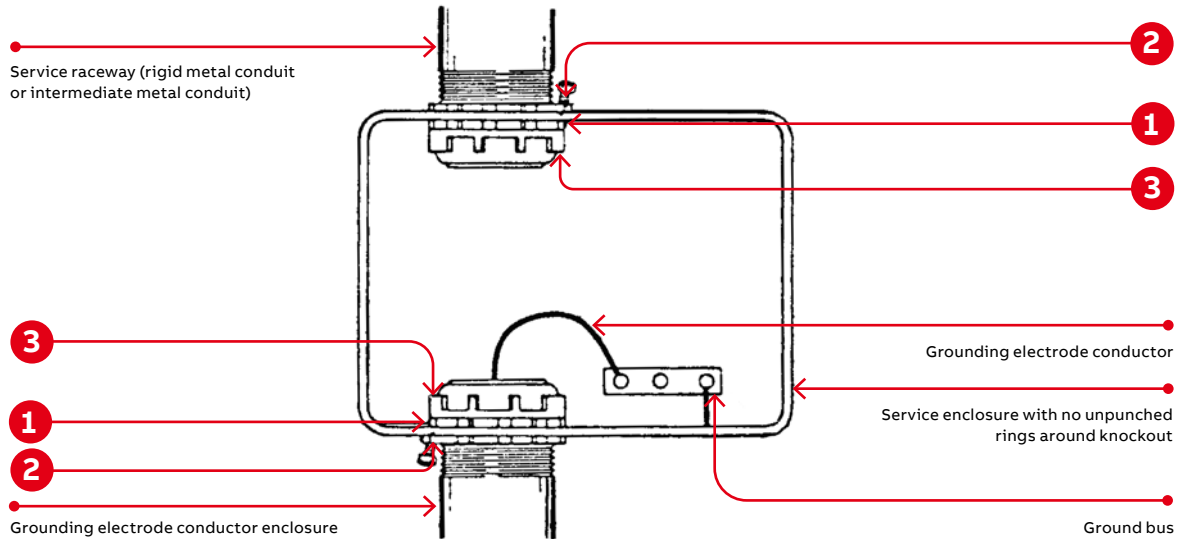

# Rigid and intermediate metal conduit fittings

## Methods of bonding and grounding

- (1) Series 142 locknut
- (2) Series 122 metallic bushing
- (3) Series 3651 bonding and grounding wedge
- (4) Pressure (crimp-type) terminal lug
- 
- 01 Series 3651 bonding and grounding wedge

### Acceptable method for bonding following

- (i) Service equipment CEC Rule 10-614
- (ii) Bonding for circuits over 250 volts CEC Rule 10-614
- (iii) Bonding in hazardous locations CEC Rule 18-074

When installed with a bonding jumper, acceptable method of bonding where unpunched rings remain around concentric or eccentric knockouts in sheet metal boxes or enclosures. (CEC Rule 10-614)

### Suggested specifications

#### Bonding and grounding wedge (series 3650)

Bonding and grounding wedges installed to effectively bond terminating fitting or metal conduit to a cabinet, box, enclosure or an auxiliary gutter or to install bonding jumper around concentric or eccentric knockouts shall be of the type as manufactured by ABB – series 3650.

Bonding and grounding wedge shall be of rugged bronze/tin-plated or steel/electro-zinc plated.

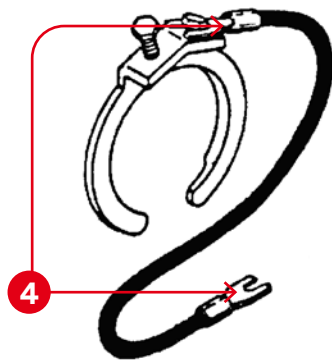

—  
01

