



CONNECT AND PROTECT

Cable Support Systems

Featuring the nVent CADDY CAT HP J-Hook System

nvent



CADDY

Why nVent CADDY Cat HP?

WHY CHOOSE CAT HP OVER TRAY?

FAST AND EASY TO INSTALL

- Much faster installation compared to conventional cable or ladder tray
- One person can install J-Hooks, tray installation requires two or more people
- No grounding or bonding required
- No extra components to install

SIMPLER SOLUTION

- Tray requires an additional support structure - nVent CADDY Cat HP does not
- Eliminates the need for special tools or connection fittings
- J-Hooks allow for easy, no-cost directional and level changes



WHY CHOOSE CAT HP OVER OTHER NON-CONTINUOUS SUPPORTS?

- Designed to help meet the requirements for high performance data cables
- Sturdy steel construction with superior cable capacity and load rating
- Fire rated solution to comply with project requirements

J-Hooks are available pre-galvanized or painted to aid in the identification and organization of the pathway application



DESIGNED TO HELP MEET THE REQUIREMENTS FOR HIGH PERFORMANCE DATA CABLES

The highly engineered Cat HP J-Hooks feature a 3" (76 mm) bend radius and comply with TIA standards for Cat 6A, Cat 7, and fiber optic cables. Many alternative J-Hook products do not meet the minimum bend radius required to install or support modern high performance data cables.

Cable Type	Avg. Diameter	Bend Radius Requirement	Minimal Bend Radius	Cat HP J-Hooks	Other Competitors with a 1" bend radius
CAT 5e	0.21"	4x	0.84"	Y	Y
CAT 6	0.23"	4x	0.92"	Y	Y
CAT 6a	0.30"	4x	1.20"	Y	N
CAT 7 (SFTP)	0.29"	8x	2.32"	Y	N
Fiber Optic (plenum)	0.20"	10 – 15x	2.0" - 3.0"	Y	N

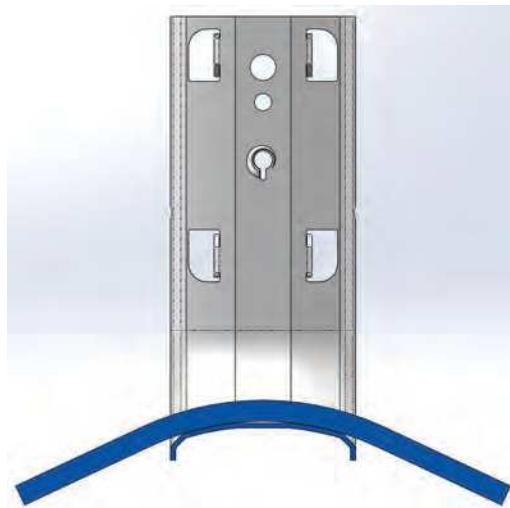

The J-Hooks have a wide base design and smooth beveled edges to provide a large bending radius for current and future high-performance data cables and fibre optics.

STURDY STEEL CONSTRUCTION WITH SUPERIOR CABLE CAPACITY AND LOAD RATING

Cat HP J-Hooks feature superior stamped steel construction and up to 4" diameter carrying capacity that can support up to 140 Cat 6A or Cat 7 high performance cables. Cat HP J-Hooks are tested and certified to an industry-leading static load rating of up to 60 pounds.

FIRE RATED SOLUTION TO COMPLY WITH PROJECT REQUIREMENTS

Cat HP J-Hooks have been tested to DIN 4102-12 and meet the requirements of E30 and E90. When project specifications call for a fire rated cable pathway, Cat HP J-Hooks are an ideal solution.



J-Hooks and cables in fire chamber before fire test



Cat HP Components

FEATURES:

- **Fully-versatile** J-Hook solution with interchangeable fasteners and support brackets
- Ideal for projects that require flexibility to adapt cable pathways on the jobsite
- Customized J-Hook trees can be easily assembled with various J-Hook sizes, colors and configurations
- Multiple color options aid in the identification and organization of the pathway application



Flange



Purlin



Rod/Wire



Tree Bracket



Pedestal



Angle Bracket



Straight Bracket

COMPONENT ASSEMBLY



J-HOOK TREE ASSEMBLY



Cat HP Assemblies

FEATURES:

- **Pre-assembled;** saving installation time & labor
- Ideal for new construction or when the structural attachment requirements are well understood
- Provides optimal support for high-performance data cable*, including CAT6, CAT6A, CAT7 and fiber optics
- Single- or double-sided tree configurations provide multiple J-Hooks with one structural attachment



* Cat HP meets TIA-568-C and TIA-569-C requirements

Cable Support Systems



NVENT CADDY CAT HP J-HOOK SYSTEM

PAGES 7-37

Our most advanced J-Hook support solution. Highly engineered features help to ensure a stable and secure installation for high-performance cables.



NVENT CADDY CAT CM CABLE SUPPORT SYSTEM

PAGES 38-41

Specially designed U-Hooks and double J-Hooks have large-diameter, rounded support surfaces/edges to avoid overbending and kinking of cables.



NVENT CADDY CAT 425 ADJUSTABLE CABLE SUPPORTS

PAGES 42-46

Adjustable fabric cable support can be mounted to overhead building structure or wall-mounted for low-profile installations.

Cat HP J-Hook System



The Cat HP J-Hook System is an advanced, non-continuous pathway support solution for today's high-performance cabling systems. Highly engineered features help ensure a stable and secure installation that complies with industry codes and standards for high-performance cables.

The Cat HP System is a cost-effective alternative to using wire mesh cable tray, ladder tray or similar complex alternatives. It requires significantly less material and installs in a fraction of the time of other methods. This versatile solution accommodates a wide range of attachment methods and is available as individual J-Hooks, pre-built Cat HP assemblies and multi-tiered trees, as well as interchangeable Cat HP components. The Cat HP J-Hook System provides the perfect combination of performance, time savings and versatility required by today's datacom and electrical contractors.

- Provides optimal support for high-performance data cable, up to and including Cat 5e, Cat 6, Cat 6A, Cat 7 and fibre optic
- Typically requires less time, labor and material for installation compared to cable tray systems
- Requires no screws, rivets or special tools for assembly
- Provides superior fill capacity and load rating over most other non-continuous cable support alternatives
- Offers a variety of attachment methods
- Engineered to accommodate future emerging data cables
- Recyclable and is produced with up to 80% recycled steel
- Uses up to 88% less material by weight than traditional cable tray methods
- Complies with EN 50174-2
- Meets ISO®/IECSM 14763-2, TIA 568-C and TIA 569-C



CAT HP J-HOOK

PAGES 7-9

Non-continuous pathway support solution with a wide base design and smooth beveled edges to provide a large bending radius for high-performance data cables and fibre optics.



CAT HP ASSEMBLIES

PAGE 10-22

Pre-built assemblies comprising a high-performance J-Hook and structure attachment, ready to use out of the box.



CAT HP J-HOOK TREES

PAGES 23-36

Pre-assembled trees comprising structural attachment and multiple tiers of Cat HP J-Hooks in single- or double-sided configurations for segregating cable runs.



CAT HP COMPONENTS

PAGES 27-35

Structure attachments and brackets for linking high performance J-Hooks to building structure or to each other in tree configurations.



CAT HP ACCESSORIES

PAGES 36-37

Accessories for the Cat HP System, designed to simplify installation.

Cat HP J-Hook



Cat HP J-Hooks are the heart of the Cat HP System. The J-Hooks have a wide base design and smooth beveled edges to provide a large bending radius for current and future high-performance data cables and fibre optics. Cat HP J-Hooks are available in a wide range of sizes to offer a solution that meets industry standards for Cat 6A and easily accommodates Cat 7, large-diameter fibre optic, innerduct and coax cable. Individual Cat HP J-Hooks can be fastened directly to the building structure or can be used to expand existing Cat HP J-Hook cable supports. The J-Hooks are designed to provide a strong and stable pathway support installation.

- Provides optimal support for high-performance data cable, up to and including Cat 5e, Cat 6, Cat 6A, Cat 7 and fibre optic
- Rounded edges on J-Hooks provide proper bend radius support for high performance data cables
- Multiple color options aid in the identification and organization of the pathway application
- Provides superior fill capacity and load rating over most other non-continuous cable support alternatives
- Tested according to DIN 4102-12
- Complies with EN 50174-2
- Meets ISO®/IECSM 14763-2, TIA 568-C and TIA 569-C

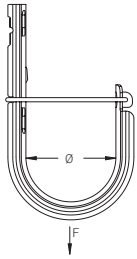

Material: Steel



Part Number	Area	Cable Capacity, Cat 5e	Cable Capacity, Cat 6	Cable Capacity, Cat 6A	Diameter Ø	Static Load F	Approvals
Finish: Pre-galvanized							
CAT16HP	1.07 in ²	20	15	10	1"	60 lb	cULus®
CAT21HP	2.29 in ²	50	40	25	1 5/16"	60 lb	cULus®
CAT32HP	3.97 in ²	90	60	35	2"	60 lb	cULus®
CAT48HP	9.26 in ²	200	150	80	3"	60 lb	cULus®
CAT64HP	15.48 in ²	330	220	140	4"	60 lb	cULus®

Part Number	Area	Cable Capacity, Cat 5e	Cable Capacity, Cat 6	Cable Capacity, Cat 6A	Diameter Ø	Static Load F	Approvals
Finish: Pre-galvanized, Painted – Color: Black							
CAT16HPBA	1.07 in ²	20	15	10	1"	60 lb	cULus®
CAT21HPBA	2.29 in ²	50	40	25	1 5/16"	60 lb	cULus®
CAT32HPBA	3.97 in ²	90	60	35	2"	60 lb	cULus®
CAT48HPBA	9.26 in ²	200	150	80	3"	60 lb	cULus®
CAT64HPBA	15.48 in ²	330	220	140	4"	60 lb	cULus®
Finish: Pre-galvanized, Painted – Color: Blue							
CAT16HPBU	1.07 in ²	20	15	10	1"	60 lb	cULus®
CAT21HPBU	2.29 in ²	50	40	25	1 5/16"	60 lb	cULus®
CAT32HPBU	3.97 in ²	90	60	35	2"	60 lb	cULus®
CAT48HPBU	9.26 in ²	200	150	80	3"	60 lb	cULus®
CAT64HPBU	15.48 in ²	330	220	140	4"	60 lb	cULus®
Finish: Pre-galvanized, Painted – Color: Green							
CAT16HPGR	1.07 in ²	20	15	10	1"	60 lb	cULus®
CAT21HPGR	2.29 in ²	50	40	25	1 5/16"	60 lb	cULus®
CAT32HPGR	3.97 in ²	90	60	35	2"	60 lb	cULus®
CAT48HPGR	9.26 in ²	200	150	80	3"	60 lb	cULus®
CAT64HPGR	15.48 in ²	330	220	140	4"	60 lb	cULus®
Finish: Pre-galvanized, Painted – Color: Orange							
CAT16HPOR	1.07 in ²	20	15	10	1"	60 lb	cULus®
CAT21HPOR	2.29 in ²	50	40	25	1 5/16"	60 lb	cULus®
CAT32HPOR	3.97 in ²	90	60	35	2"	60 lb	cULus®
CAT48HPOR	9.26 in ²	200	150	80	3"	60 lb	cULus®
CAT64HPOR	15.48 in ²	330	220	140	4"	60 lb	cULus®
Finish: Pre-galvanized, Painted – Color: Red							
CAT16HPRD	1.07 in ²	20	15	10	1"	60 lb	cULus®
CAT21HPRD	2.29 in ²	50	40	25	1 5/16"	60 lb	cULus®
CAT32HPRD	3.97 in ²	90	60	35	2"	60 lb	cULus®
CAT48HPRD	9.26 in ²	200	150	80	3"	60 lb	cULus®
CAT64HPRD	15.48 in ²	330	220	140	4"	60 lb	cULus®
Finish: Pre-galvanized, Painted – Color: White							
CAT16HPWH	1.07 in ²	20	15	10	1"	60 lb	cULus®
CAT21HPWH	2.29 in ²	50	40	25	1 5/16"	60 lb	cULus®
CAT32HPWH	3.97 in ²	90	60	35	2"	60 lb	cULus®
CAT48HPWH	9.26 in ²	200	150	80	3"	60 lb	cULus®
CAT64HPWH	15.48 in ²	330	220	140	4"	60 lb	cULus®
Finish: Pre-galvanized, Painted – Color: Yellow							
CAT16HPYL	1.07 in ²	20	15	10	1"	60 lb	cULus®
CAT21HPYL	2.29 in ²	50	40	25	1 5/16"	60 lb	cULus®
CAT32HPYL	3.97 in ²	90	60	35	2"	60 lb	cULus®
CAT48HPYL	9.26 in ²	200	150	80	3"	60 lb	cULus®
CAT64HPYL	15.48 in ²	330	220	140	4"	60 lb	cULus®

Non-continuous supports may not exceed spacing of 5' (1.5 m) per TIA 569-C.9.7.

Cable capacity is calculated based on a 70% fill rate.

Cat HP Assemblies



Cat HP assemblies are the fastest CATs in the Cat HP family by providing a high-performance J-Hook solution in a single assembly. They are ready to use right out of the box with a broad range of attachment methods. Cat HP assemblies are ideal for new construction or when the structural attachment requirements are well understood and installation speed is critical.

- Provides optimal support for high-performance data cable, up to and including Cat 5e, Cat 6, Cat 6A, Cat 7 and fibre optic
- Ready to use out of the box, saving installation time and labor
- Available in a variety of attachment methods, including beam flanges, purlin, rod or wire, T-Grid and other common mounting configurations
- Provides superior fill capacity and load rating over most other non-continuous cable support alternatives
- Meets ISO®/IECSM 14763-2, TIA 568-C and TIA 569-C



Cat HP J-Hook to Flange



Cat HP J-Hook to Purlin



Cat HP J-Hook to Rod/Wire



Cat HP J-Hook to Concrete



Cat HP J-Hook to Pedestal



Cat HP J-Hook to Strut



Cat HP J-Hook to T-Grid

Cat HP J-Hook with BC200 Beam Clamp

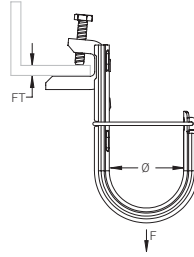

- Easy installation to beam flanges
- Provides optimal support for high-performance data cable, up to and including Cat 5e, Cat 6, Cat 6A, Cat 7 and fibre optic
- Provides superior fill capacity and load rating over most other non-continuous cable support alternatives
- Rounded edges on J-Hooks provide proper bend radius support for high performance data cables
- Cost effective alternative to expensive cable tray
- Complies with EN 50174-2
- Meets ISO®/IECSM 14763-2, TIA 568-C and TIA 569-C



Material: Steel
Finish: Pre-galvanized

Part Number	Area	Cable Capacity, Cat 5e	Cable Capacity, Cat 6	Cable Capacity, Cat 6A	Diameter Ø	Flange Thickness FT	Static Load F	Approvals
CAT16HPBC200	1.07 in ²	20	15	10	1"	1/2" Max	60 lb	cULus®
CAT21HPBC200	2.29 in ²	50	40	25	1 5/16"	1/2" Max	60 lb	cULus®
CAT32HPBC200	3.97 in ²	90	60	35	2"	1/2" Max	60 lb	cULus®
CAT48HPBC200	9.26 in ²	200	150	80	3"	1/2" Max	60 lb	cULus®
CAT64HPBC200	15.48 in ²	330	220	140	4"	1/2" Max	60 lb	cULus®

Setscrew must be tightened and torqued onto the sloped side of the I-beam.
Non-continuous supports may not exceed spacing of 5' (1.5 m) per TIA 569-C.9.7.
Cable capacity is calculated based on a 70% fill rate.

Cat HP J-Hook with BC200 Beam Clamp, Swivel

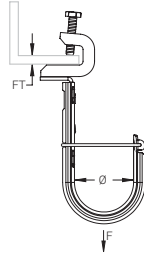

- Easy installation to beam flanges
- Swivels to support various directional runs of cable
- Provides optimal support for high-performance data cable, up to and including Cat 5e, Cat 6, Cat 6A, Cat 7 and fibre optic
- Provides superior fill capacity and load rating over most other non-continuous cable support alternatives
- Rounded edges on J-Hooks provide proper bend radius support for high performance data cables
- Cost effective alternative to expensive cable tray
- Complies with EN 50174-2
- Meets ISO[®]/IECSM 14763-2, TIA 568-C and TIA 569-C

Material: Steel
Finish: Pre-galvanized



Part Number	Area	Cable Capacity, Cat 5e	Cable Capacity, Cat 6	Cable Capacity, Cat 6A	Diameter Ø	Flange Thickness FT	Static Load F	Approvals
CAT16HPBC200B	1.07 in ²	20	15	10	1"	1/2" Max	60 lb	cULus [®]
CAT21HPBC200B	2.29 in ²	50	40	25	1 5/16"	1/2" Max	60 lb	cULus [®]
CAT32HPBC200B	3.97 in ²	90	60	35	2"	1/2" Max	60 lb	cULus [®]
CAT48HPBC200B	9.26 in ²	200	150	80	3"	1/2" Max	60 lb	cULus [®]
CAT64HPBC200B	15.48 in ²	330	220	140	4"	1/2" Max	60 lb	cULus [®]

Setscrew must be tightened and torqued onto the sloped side of the I-beam.
Non-continuous supports may not exceed spacing of 5' (1.5 m) per TIA 569-C.9.7.
Cable capacity is calculated based on a 70% fill rate.

Cat HP J-Hook with BC Beam Clamp

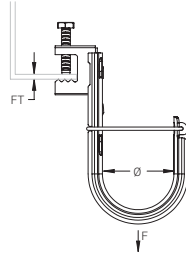

- Easy installation to beam flanges
- Provides optimal support for high-performance data cable, up to and including Cat 5e, Cat 6, Cat 6A, Cat 7 and fibre optic
- Provides superior fill capacity and load rating over most other non-continuous cable support alternatives
- Rounded edges on J-Hooks provide proper bend radius support for high performance data cables
- Cost effective alternative to expensive cable tray
- Complies with EN 50174-2
- Meets ISO®/IECSM 14763-2, TIA 568-C and TIA 569-C

Material: Steel, Spring Steel

Finish: Pre-galvanized, nVent CADDY Armour



Part Number	Area	Cable Capacity, Cat 5e	Cable Capacity, Cat 6	Cable Capacity, Cat 6A	Diameter Ø	Flange Thickness FT	Static Load F	Approvals
CAT16HPBC	1.07 in ²	20	15	10	1"	1/2" Max	60 lb	cULus®
CAT21HPBC	2.29 in ²	50	40	25	1 5/16"	1/2" Max	60 lb	cULus®
CAT32HPBC	3.97 in ²	90	60	35	2"	1/2" Max	60 lb	cULus®
CAT48HPBC	9.26 in ²	220	140	80	3"	1/2" Max	60 lb	cULus®
CAT64HPBC	15.48 in ²	330	220	140	4"	1/2" Max	60 lb	cULus®

Non-continuous supports may not exceed spacing of 5' (1.5 m) per TIA 569-C.9.7.

Cable capacity is calculated based on a 70% fill rate.

Cat HP J-Hook with BC Beam Clamp, Swivel

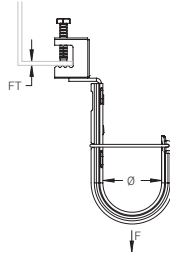

- Easy installation to beam flanges
- Swivels to support various directional runs of cable
- Provides optimal support for high-performance data cable, up to and including Cat 5e, Cat 6, Cat 6A, Cat 7 and fibre optic
- Provides superior fill capacity and load rating over most other non-continuous cable support alternatives
- Rounded edges on J-Hooks provide proper bend radius support for high performance data cables
- Cost effective alternative to expensive cable tray
- Complies with EN 50174-2
- Meets ISO®/IECSM 14763-2, TIA 568-C and TIA 569-C

Material: Steel, Spring Steel
Finish: Pre-galvanized, Armour



Part Number	Area	Cable Capacity, Cat 5e	Cable Capacity, Cat 6	Cable Capacity, Cat 6A	Diameter Ø	Flange Thickness FT	Static Load F	Approvals
CAT16HPBCB	1.07 in ²	20	15	10	1"	1/2" Max	60 lb	cULus®
CAT21HPBCB	2.29 in ²	50	40	25	1 5/16"	1/2" Max	60 lb	cULus®
CAT32HPBCB	3.97 in ²	90	60	35	2"	1/2" Max	60 lb	cULus®
CAT48HPBCB	9.26 in ²	200	150	80	3"	1/2" Max	60 lb	cULus®
CAT64HPBCB	15.48 in ²	330	220	140	4"	1/2" Max	60 lb	cULus®

Non-continuous supports may not exceed spacing of 5' (1.5 m) per TIA 569-C.9.7.

Cable capacity is calculated based on a 70% fill rate.

Cat HP J-Hook with Hammer-On Flange Clip

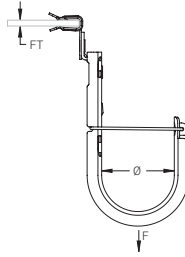

- Requires only a hammer to install
- Provides optimal support for high-performance data cable, up to and including Cat 5e, Cat 6, Cat 6A, Cat 7 and fibre optic
- Provides superior fill capacity and load rating over most other non-continuous cable support alternatives
- Rounded edges on J-Hooks provide proper bend radius support for high performance data cables
- Cost effective alternative to expensive cable tray
- Complies with EN 50174-2
- Meets ISO®/IECSM 14763-2, TIA 568-C and TIA 569-C

Material: Steel, Spring Steel
Finish: Pre-galvanized, Armour



Part Number	Area	Cable Capacity, Cat 5e	Cable Capacity, Cat 6	Cable Capacity Cat 6A	Diameter Ø	Flange Thickness FT	Static Load F	Approvals
CAT16HP24SM	1.07 in ²	20	15	10	1"	1/8" – 1/4"	60 lb	cULus®
CAT16HP58SM	1.07 in ²	20	15	10	1"	5/16" – 1/2"	60 lb	cULus®
CAT16HP912SM	1.07 in ²	20	15	10	1"	1/2" – 3/4"	60 lb	cULus®
CAT21HP24SM	2.29 in ²	50	40	25	1 5/16"	1/8" – 1/4"	60 lb	cULus®
CAT21HP58SM	2.29 in ²	50	40	25	1 5/16"	5/16" – 1/2"	60 lb	cULus®
CAT21HP912SM	2.29 in ²	50	40	25	1 5/16"	1/2" – 3/4"	60 lb	cULus®
CAT32HP24SM	3.97 in ²	90	60	35	2"	1/8" – 1/4"	60 lb	cULus®
CAT32HP58SM	3.97 in ²	90	60	35	2"	5/16" – 1/2"	60 lb	cULus®
CAT32HP912SM	3.97 in ²	90	60	35	2"	1/2" – 3/4"	60 lb	cULus®
CAT48HP24SM	9.26 in ²	200	150	80	3"	1/8" – 1/4"	60 lb	cULus®
CAT48HP58SM	9.26 in ²	200	150	80	3"	5/16" – 1/2"	60 lb	cULus®
CAT48HP912SM	9.26 in ²	200	150	80	3"	1/2" – 3/4"	60 lb	cULus®
CAT64HP24SM	15.48 in ²	330	220	140	4"	1/8" – 1/4"	60 lb	cULus®
CAT64HP58SM	15.48 in ²	330	220	140	4"	5/16" – 1/2"	60 lb	cULus®
CAT64HP912SM	15.48 in ²	330	220	140	4"	1/2" – 3/4"	60 lb	cULus®

Non-continuous supports may not exceed spacing of 5' (1.5 m) per TIA 569-C.9.7.
Cable capacity is calculated based on a 70% fill rate.

Cat HP J-Hook with Hammer-On Flange Clip, Swivel

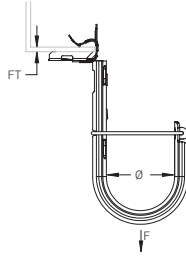

- Requires only a hammer to install
- Swivels to support various directional runs of cable
- Provides optimal support for high-performance data cable, up to and including Cat 5e, Cat 6, Cat 6A, Cat 7 and fibre optic
- Provides superior fill capacity and load rating over most other non-continuous cable support alternatives
- Rounded edges on J-Hooks provide proper bend radius support for high performance data cables
- Cost effective alternative to expensive cable tray
- Complies with EN 50174-2
- Meets ISO®/IECSM 14763-2, TIA 568-C and TIA 569-C

Material: Steel, Spring Steel
Finish: Pre-galvanized, Armour



Part Number	Area	Cable Capacity, Cat 5e	Cable Capacity, Cat 6	Cable Capacity, Cat 6A	Diameter Ø	Flange Thickness FT	Static Load F	Approvals
CAT16HP24	1.07 in ²	20	15	10	1"	1/8" – 1/4"	60 lb	cULus®
CAT16HP58	1.07 in ²	20	15	10	1"	5/16" – 1/2"	60 lb	cULus®
CAT16HP912	1.07 in ²	20	15	10	1"	1/2" – 3/4"	60 lb	cULus®
CAT21HP24	2.29 in ²	50	40	25	1 5/16"	1/8" – 1/4"	60 lb	cULus®
CAT21HP58	2.29 in ²	50	40	25	1 5/16"	5/16" – 1/2"	60 lb	cULus®
CAT21HP912	2.29 in ²	50	40	25	1 5/16"	1/2" – 3/4"	60 lb	cULus®
CAT32HP24	3.97 in ²	90	60	35	2"	1/8" – 1/4"	60 lb	cULus®
CAT32HP58	3.97 in ²	90	60	35	2"	5/16" – 1/2"	60 lb	cULus®
CAT32HP912	3.97 in ²	90	60	35	2"	1/2" – 3/4"	60 lb	cULus®
CAT48HP24	9.26 in ²	200	150	80	3"	1/8" – 1/4"	60 lb	cULus®
CAT48HP58	9.26 in ²	200	150	80	3"	5/16" – 1/2"	60 lb	cULus®
CAT48HP912	9.26 in ²	200	150	80	3"	1/2" – 3/4"	60 lb	cULus®
CAT64HP24	15.48 in ²	330	220	140	4"	1/8" – 1/4"	60 lb	cULus®
CAT64HP58	15.48 in ²	330	220	140	4"	5/16" – 1/2"	60 lb	cULus®
CAT64HP912	15.48 in ²	330	220	140	4"	1/2" – 3/4"	60 lb	cULus®

Non-continuous supports may not exceed spacing of 5' (1.5 m) per TIA 569-C.9.7.
Cable capacity is calculated based on a 70% fill rate.

Cat HP J-Hook with C Purlin Clip

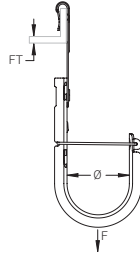

- Requires only a hammer to install
- Provides optimal support for high-performance data cable, up to and including Cat 5e, Cat 6, Cat 6A, Cat 7 and fibre optic
- Provides superior fill capacity and load rating over most other non-continuous cable support alternatives
- Rounded edges on J-Hooks provide proper bend radius support for high performance data cables
- Cost effective alternative to expensive cable tray
- Complies with EN 50174-2
- Meets ISO®/IECSM 14763-2, TIA 568-C and TIA 569-C

Material: Steel, Spring Steel
 Finish: Pre-galvanized, Armour



Part Number	Area	Cable Capacity, Cat 5e	Cable Capacity, Cat 6	Cable Capacity, Cat 6A	Diameter Ø	Flange Thickness FT	Static Load F	Approvals
CAT16HPVF14	1.07 in ²	20	15	10	1"	1/16" – 1/4"	60 lb	cULus®
CAT21HPVF14	2.29 in ²	50	40	25	1 5/16"	1/16" – 1/4"	60 lb	cULus®
CAT32HPVF14	3.97 in ²	90	60	35	2"	1/16" – 1/4"	60 lb	cULus®
CAT48HPVF14	9.26 in ²	200	150	80	3"	1/16" – 1/4"	60 lb	cULus®
CAT64HPVF14	15.48 in ²	330	220	140	4"	1/16" – 1/4"	60 lb	cULus®

Non-continuous supports may not exceed spacing of 5' (1.5 m) per TIA 569-C.9.7.
 Cable capacity is calculated based on a 70% fill rate.

Cat HP J-Hook with Z Purlin Clip

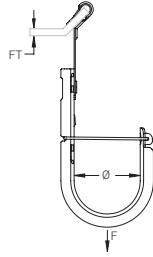

- Requires only a hammer to install
- Provides optimal support for high-performance data cable, up to and including Cat 5e, Cat 6, Cat 6A, Cat 7 and fibre optic
- Provides superior fill capacity and load rating over most other non-continuous cable support alternatives
- Rounded edges on J-Hooks provide proper bend radius support for high performance data cables
- Cost effective alternative to expensive cable tray
- Complies with EN 50174-2
- Meets ISO®/IECSM 14763-2, TIA 568-C and TIA 569-C

Material: Steel, Spring Steel
Finish: Pre-galvanized, Armour



Part Number	Area	Cable Capacity, Cat 5e	Cable Capacity, Cat 6	Cable Capacity, Cat 6A	Diameter Ø	Flange Thickness FT	Static Load F	Approvals
CAT16HPAF14	1.07 in ²	20	15	10	1"	1/16" – 1/4"	60 lb	cULus®
CAT21HPAF14	2.29 in ²	50	40	25	1 5/16"	1/16" – 1/4"	60 lb	cULus®
CAT32HPAF14	3.97 in ²	90	60	35	2"	1/16" – 1/4"	60 lb	cULus®
CAT48HPAF14	9.26 in ²	200	150	80	3"	1/16" – 1/4"	60 lb	cULus®
CAT64HPAF14	15.48 in ²	330	220	140	4"	1/16" – 1/4"	60 lb	cULus®

Non-continuous supports may not exceed spacing of 5' (1.5 m) per TIA 569-C.9.7.
Cable capacity is calculated based on a 70% fill rate.

Cat HP J-Hook with Multi-Function Clip

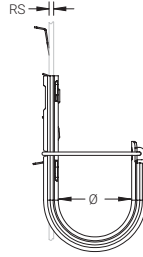

- Quick attachment to threaded rod or wire
- Provides optimal support for high-performance data cable, up to and including Cat 5e, Cat 6, Cat 6A, Cat 7 and fibre optic
- Provides superior fill capacity and load rating over most other non-continuous cable support alternatives
- Rounded edges on J-Hooks provide proper bend radius support for high performance data cables
- Cost effective alternative to expensive cable tray
- Complies with EN 50174-2
- Meets ISO®/IECSM 14763-2, TIA 568-C and TIA 569-C

Material: Steel, Spring Steel
 Finish: Pre-galvanized, Armour



Part Number	Area	Cable Capacity, Cat 5e	Cable Capacity, Cat 6	Cable Capacity, Cat 6A	Diameter Ø	Rod Size RS	Wire Size	Static Load F	Approvals
CAT16HP4Z34	1.07 in ²	20	15	10	1"	1/4"	#12 – #8	30 lb	cULus®
CAT16HP6Z34	1.07 in ²	20	15	10	1"	3/8"	–	30 lb	cULus®
CAT21HP4Z34	2.29 in ²	50	40	25	1 5/16"	1/4"	#12 – #8	30 lb	cULus®
CAT21HP6Z34	2.29 in ²	50	40	25	1 5/16"	3/8"	–	30 lb	cULus®
CAT32HP4Z34	3.97 in ²	90	60	35	2"	1/4"	#12 – #8	30 lb	cULus®
CAT32HP6Z34	3.97 in ²	90	60	35	2"	3/8"	–	30 lb	cULus®

Non-continuous supports may not exceed spacing of 5' (1.5 m) per TIA 569-C.9.7.
 Cable capacity is calculated based on a 70% fill rate.

Cat HP J-Hook with Pin Driven Angle Bracket

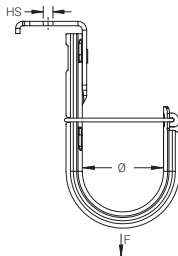

- Longer leg angle bracket for tool clearance
- Designed to fit a variety of pin drivers
- Swivels to support various directional runs of cable
- Provides optimal support for high-performance data cable, up to and including Cat 5e, Cat 6, Cat 6A, Cat 7 and fibre optic
- Provides superior fill capacity and load rating over most other non-continuous cable support alternatives
- Rounded edges on J-Hooks provide proper bend radius support for high performance data cables
- Cost effective alternative to expensive cable tray
- Complies with EN 50174-2
- Meets ISO®/IECSM 14763-2, TIA 568-C and TIA 569-C

Material: Steel

Finish: Pre-galvanized



Part Number	Area	Cable Capacity, Cat 5e	Cable Capacity, Cat 6	Cable Capacity, Cat 6A	Diameter Ø	Hole Size HS	Static Load F	Approvals
CAT16HPAFAB3	1.07 in ²	20	15	10	1"	3/16"	60 lb	cULus®
CAT21HPAFAB3	2.29 in ²	50	40	25	1 5/16"	3/16"	60 lb	cULus®
CAT21HPAFAB4	2.29 in ²	50	40	25	1 5/16"	1/4"	60 lb	cULus®
CAT21HPAFAB6	2.29 in ²	50	40	25	1 5/16"	3/8"	60 lb	cULus®
CAT32HPAFAB3	3.97 in ²	90	60	35	2"	3/16"	60 lb	cULus®
CAT32HPAFAB4	3.97 in ²	90	60	35	2"	1/4"	60 lb	cULus®
CAT32HPAFAB6	3.97 in ²	90	60	35	2"	3/8"	60 lb	cULus®
CAT48HPAFAB3	9.26 in ²	200	150	80	3"	3/16"	60 lb	cULus®
CAT48HPAFAB4	9.26 in ²	200	150	80	3"	1/4"	60 lb	cULus®
CAT48HPAFAB6	9.26 in ²	200	150	80	3"	3/8"	60 lb	cULus®
CAT64HPAFAB3	15.48 in ²	330	220	140	4"	3/16"	60 lb	cULus®
CAT64HPAFAB4	15.48 in ²	330	220	140	4"	1/4"	60 lb	cULus®
CAT64HPAFAB6	15.48 in ²	330	220	140	4"	3/8"	60 lb	cULus®

Non-continuous supports may not exceed spacing of 5' (1.5 m) per TIA 569-C.9.7.

Cable capacity is calculated based on a 70% fill rate.

Cat HP J-Hook with Angle Bracket

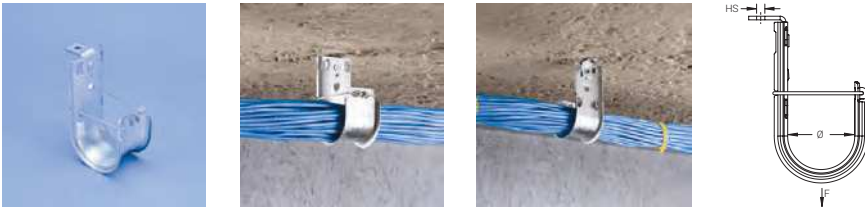

- Ideal for attaching to concrete, steel or wood surfaces
- Provides optimal support for high-performance data cable, up to and including Cat 5e, Cat 6, Cat 6A, Cat 7 and fibre optic
- Provides superior fill capacity and load rating over most other non-continuous cable support alternatives
- Rounded edges on J-Hooks provide proper bend radius support for high performance data cables
- Cost effective alternative to expensive cable tray
- Complies with EN 50174-2
- Meets ISO®/IECSM 14763-2, TIA 568-C and TIA 569-C

Material: Steel
Finish: Pre-galvanized



Part Number	Area	Cable Capacity, Cat 5e	Cable Capacity, Cat 6	Cable Capacity, Cat 6A	Diameter Ø	Hole Size HS	Static Load F	Approvals
CAT16HPAB	1.07 in ²	20	15	10	1"	1/4"	60 lb	cULus®
CAT21HPAB	2.29 in ²	50	40	25	1 5/16"	1/4"	60 lb	cULus®
CAT32HPAB	3.97 in ²	90	60	35	2"	1/4"	60 lb	cULus®
CAT48HPAB	9.26 in ²	200	150	80	3"	1/4"	60 lb	cULus®
CAT64HPAB	15.48 in ²	330	220	140	4"	1/4"	60 lb	cULus®

Non-continuous supports may not exceed spacing of 5' (1.5 m) per TIA 569-C.9.7.
Cable capacity is calculated based on a 70% fill rate.

Cat HP J-Hook with Strut Attachment Clip

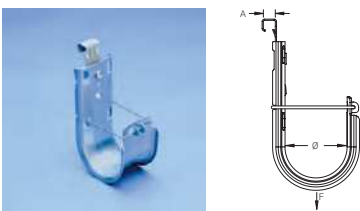

- Attaches to open side of a strut channel
- Provides optimal support for high-performance data cable, up to and including Cat 5e, Cat 6, Cat 6A, Cat 7 and fibre optic
- Provides superior fill capacity and load rating over most other non-continuous cable support alternatives
- Cost effective alternative to expensive cable tray
- Complies with EN 50174-2
- Meets ISO®/IECSM 14763-2, TIA 568-C and TIA 569-C

Material: Steel, Spring Steel
Finish: Pre-galvanized, Armour



Part Number	Area	Cable Capacity, Cat 5e	Cable Capacity, Cat 6	Cable Capacity, Cat 6A	Diameter Ø	A	Static Load F	Approvals
CAT16HPESC	1.07 in ²	20	15	10	1"	25/64"	60 lb	-
CAT21HPESC	2.29 in ²	50	40	25	1 5/16"	25/64"	60 lb	cULus®
CAT32HPESC	3.97 in ²	90	60	35	2"	25/64"	60 lb	-

Non-continuous supports may not exceed spacing of 5' (1.5 m) per TIA 569-C.9.7.
Cable capacity is calculated based on a 70% fill rate.

Cat HP J-Hook with Pedestal Clamp

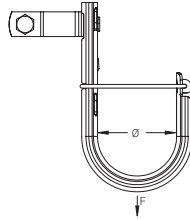

- Easy installation to pedestals used under raised floors
- Provides optimal support for high-performance data cable, up to and including Cat 5e, Cat 6, Cat 6A, Cat 7 and fibre optic
- Provides superior fill capacity and load rating over most other non-continuous cable support alternatives
- Cost effective alternative to expensive cable tray
- Complies with EN 50174-2
- Meets ISO®/IECSM 14763-2, TIA 568-C and TIA 569-C

Material: Steel

Finish: Pre-galvanized



Part Number	Area	Cable Capacity, Cat 5e	Cable Capacity, Cat 6	Cable Capacity, Cat 6A	Diameter Ø	Static Load F	Approvals
CAT16HPCD1B	1.07 in ²	20	15	10	1"	60 lb	cULus®
CAT21HPCD1B	2.29 in ²	50	40	25	1 5/16"	60 lb	cULus®
CAT32HPCD1B	3.97 in ²	90	60	35	2"	60 lb	cULus®
CAT48HPCD1B	9.26 in ²	200	150	80	3"	60 lb	cULus®
CAT64HPCD1B	15.48 in ²	330	220	140	4"	60 lb	cULus®

Non-continuous supports may not exceed spacing of 5' (1.5 m) per TIA 569-C.9.7. Cable capacity is calculated based on a 70% fill rate.

Cat HP J-Hook with T-Grid Clip

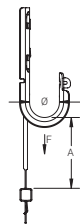

- No installation tools required for basic clip
- Provides optimal support for high-performance data cable, up to and including Cat 5e, Cat 6, Cat 6A, Cat 7 and fibre optic
- Provides superior fill capacity and load rating over most other non-continuous cable support alternatives
- Rounded edges on J-Hooks provide proper bend radius support for high performance data cables
- Cost effective alternative to expensive cable tray
- Complies with EN 50174-2
- Meets ISO®/IECSM 14763-2, TIA 568-C and TIA 569-C

Material: Steel, Spring Steel

Finish: Armour, Pre-galvanized



Part Number	Area	Cable Capacity, Cat 5e	Cable Capacity, Cat 6	Cable Capacity, Cat 6A	Diameter Ø	A	Static Load F
CAT16HPTS	1.07 in ²	20	15	10	1"	2 9/16"	60 lb

Additional support wire required per NEC® 300.11. Non-continuous supports may not exceed spacing of 5' (1.5 m) per TIA 569-C.9.7. Cable capacity is calculated based on a 70% fill rate.

Cat HP J-Hook Trees



Cat HP J-Hook Trees are the ideal solution for segregating multiple runs of cable following the same path. They are ready to use right out of the box with a broad range of sizes and attachment methods.

- Provides optimal support for high-performance data cable, up to and including Cat 5e, Cat 6, Cat 6A, Cat 7 and fibre optic
- Ready to use out of the box, saving installation time and labor
- Requires no screws, rivets or special tools for assembly
- Single- or double-sided tree configurations provide multiple J-Hooks with one structural attachment
- Provides superior fill capacity and load rating over most other non-continuous cable support alternatives
- Meets ISO®/IECSM 14763-2, TIA 568-C and TIA 569-C



Cat HP J-Hook Tree, Ceiling Mount



Cat HP J-Hook Tree, Flange Mount



Cat HP J-Hook Tree, Wall Mount

Cat HP J-Hook Tree, Ceiling Mount

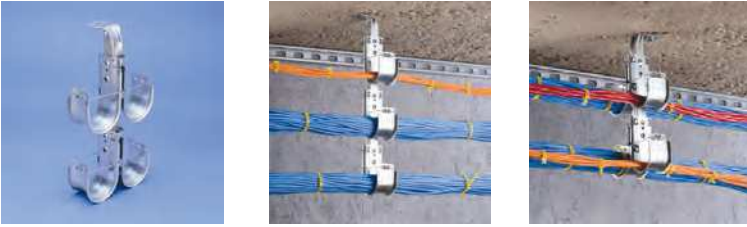

- Ideal for attaching to concrete, steel or wood surfaces
- Provides optimal support for high-performance data cable, up to and including Cat 5e, Cat 6, Cat 6A, Cat 7 and fibre optic
- Ready to use out of the box, saving installation time and labor
- Requires no screws, rivets or special tools for assembly
- Single- or double-sided tree configurations provide multiple J-Hooks with one structural attachment
- Provides superior fill capacity and load rating over most other non-continuous cable support alternatives
- Complies with EN 50174-2
- Meets ISO®/IECSM 14763-2, TIA 568-C and TIA 569-C

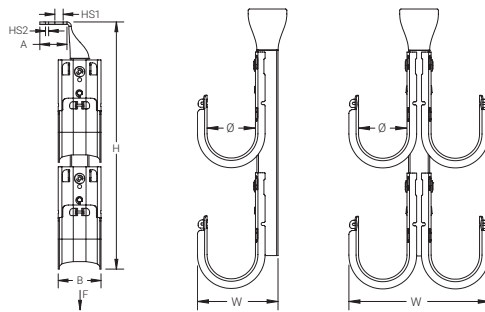

Material: Steel
Finish: Pre-galvanized



Part Number	Diameter Ø	Tiers	Height H	Width W	Hole Size 1 HS1	Hole Size 2 HS2	A	B	Static Load 1 F1	Static Load 2 F2
Type: Single Sided										
CAT32HPSCM2	2"	2	10 1/4"	3 5/16"	0.405"	0.185"	1 7/16"	2"	120 lb	120 lb
CAT32HPSCM3	2"	3	15 1/4"	3 5/16"	0.405"	0.185"	1 7/16"	2"	180 lb	180 lb
CAT32HPSCM4	2"	4	20 1/4"	3 5/16"	0.405"	0.185"	1 7/16"	2"	240 lb	180 lb
CAT64HPSCM2	4"	2	15 1/4"	5 7/16"	0.405"	0.185"	1 7/16"	2"	120 lb	120 lb
CAT64HPSCM3	4"	3	22 3/4"	5 7/16"	0.405"	0.185"	1 7/16"	2"	180 lb	180 lb
CAT64HPSCM4	4"	4	30 1/4"	5 7/16"	0.405"	0.185"	1 7/16"	2"	240 lb	180 lb
Type: Double Sided										
CAT32HPDCM2	2"	2	10 1/4"	5 13/16"	0.405"	0.185"	1 7/16"	2"	240 lb	180 lb
CAT32HPDCM3	2"	3	15 1/4"	5 13/16"	0.405"	0.185"	1 7/16"	2"	360 lb	180 lb
CAT32HPDCM4	2"	4	20 1/4"	5 13/16"	0.405"	0.185"	1 7/16"	2"	480 lb	180 lb
CAT64HPDCM2	4"	2	15 1/4"	10"	0.405"	0.185"	1 7/16"	2"	240 lb	180 lb
CAT64HPDCM3	4"	3	22 3/4"	10"	0.405"	0.185"	1 7/16"	2"	360 lb	180 lb
CAT64HPDCM4	4"	4	30 1/4"	10"	0.405"	0.185"	1 7/16"	2"	480 lb	180 lb

Static loads represent maximum load limit of J-Hook tree. Static load limit of each J-Hook is 60 lb (270 N).

Refer to Static Load 1 when fastening J-Hook tree using Hole Size 1. Refer to Static Load 2 when fastening J-Hook tree using Hole Size 2.

Non-continuous supports may not exceed spacing of 5' (1.5 m) per TIA 569-C.9.7.

Cat HP J-Hook Tree, Flange Mount



- Easy installation to beam flanges
- Provides optimal support for high-performance data cable, up to and including Cat 5e, Cat 6, Cat 6A, Cat 7 and fibre optic
- Ready to use out of the box, saving installation time and labor
- Requires no screws, rivets or special tools for assembly
- Single- or double-sided tree configurations provide multiple J-Hooks with one structural attachment
- Provides superior fill capacity and load rating over most other non-continuous cable support alternatives
- Complies with EN 50174-2
- Meets ISO®/IECSM 14763-2, TIA 568-C and TIA 569-C

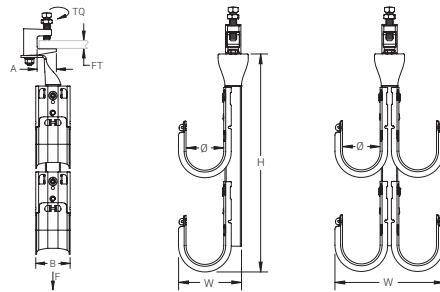

Material: Steel
Finish: Pre-galvanized



Part Number	Tiers	Diameter Ø	Flange Thickness FT	Height H	Width W	A	B	Torque TQ	Static Load F
Type: Single Sided									
CAT32HPSFM2	2	2"	13/16" Max	10 1/4"	3 5/16"	1 1/8"	2"	5 ft lb	120 lb
CAT32HPSFM3	3	2"	13/16" Max	15 1/4"	3 5/16"	1 1/8"	2"	5 ft lb	180 lb
CAT32HPSFM4	4	2"	13/16" Max	30 1/4"	3 5/16"	1 1/8"	2"	5 ft lb	240 lb
CAT64HPSFM2	2	4"	13/16" Max	15 1/4"	5 7/16"	1 1/8"	2"	5 ft lb	120 lb
CAT64HPSFM3	3	4"	13/16" Max	22 3/4"	5 7/16"	1 1/8"	2"	5 ft lb	180 lb
CAT64HPSFM4	4	4"	13/16" Max	30 1/4"	5 7/16"	1 1/8"	2"	5 ft lb	240 lb
Type: Double Sided									
CAT32HPDFM2	2	2"	13/16" Max	10 1/4"	5 13/16"	1 1/8"	2"	5 ft lb	240 lb
CAT32HPDFM3	3	2"	13/16" Max	15 1/4"	5 13/16"	1 1/8"	2"	8 ft lb	360 lb
CAT32HPDFM4	4	2"	13/16" Max	20 1/4"	5 13/16"	1 1/8"	2"	8 ft lb	480 lb
CAT64HPDFM2	2	4"	13/16" Max	15 1/4"	10"	1 1/8"	2"	5 ft lb	240 lb
CAT64HPDFM3	3	4"	13/16" Max	22 3/4"	10"	1 1/8"	2"	8 ft lb	360 lb
CAT64HPDFM4	4	4"	13/16" Max	30 1/4"	10"	1 1/8"	2"	8 ft lb	480 lb

Static loads represent maximum load limit of J-Hook tree. Static load limit of each J-Hook is 60 lb (270 N).

Setscrew must be tightened and torqued onto the sloped side of the I-beam.

Non-continuous supports may not exceed spacing of 5' (1.5 m) per TIA 569-C.9.7.

Recognizing that torque wrenches are generally not used or available on many job sites, the setscrew should be tightened so it contacts the I-beam and then an additional 1/4 to 1/2 turn added.

Cat HP J-Hook Tree, Wall Mount



- Ideal for attaching to concrete, steel or wood surfaces
- Provides optimal support for high-performance data cable, up to and including Cat 5e, Cat 6, Cat 6A, Cat 7 and fibre optic
- Ready to use out of the box, saving installation time and labor
- Requires no screws, rivets or special tools for assembly
- Provides superior fill capacity and load rating over most other non-continuous cable support alternatives
- Complies with EN 50174-2
- Meets ISO®/IECSM 14763-2, TIA 568-C and TIA 569-C

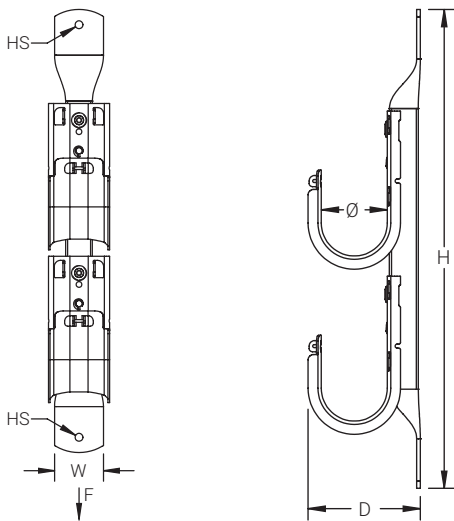

Material: Steel
 Finish: Pre-galvanized
 Type: Single Sided



Part Number	Diameter Ø	Tiers	Height H	Depth D	Width W	Hole Size HS	Static Load F
CAT32HPSWM2	2"	2	14 1/2"	3 3/8"	2"	1/4"	120 lb
CAT32HPSWM3	2"	3	19 1/2"	3 3/8"	2"	1/4"	180 lb
CAT32HPSWM4	2"	4	24 1/2"	3 3/8"	2"	1/4"	240 lb
CAT64HPSWM2	4"	2	19 1/2"	5 1/2"	2"	1/4"	120 lb
CAT64HPSWM3	4"	3	27"	5 1/2"	2"	1/4"	180 lb
CAT64HPSWM4	4"	4	34 1/2"	5 1/2"	2"	1/4"	240 lb

Static loads represent maximum load limit of J-Hook tree. Static load limit of each J-Hook is 60 lb (270 N).

Non-continuous supports may not exceed spacing of 5' (1.5 m) per TIA 569-C.9.7.

Cat HP Components



Cat HP components offer a high-performance J-Hook solution with interchangeable fasteners and support brackets. The components can be used to link together multiple J-Hooks to meet specific jobsite cable support requirements. Cat HP components are ideal for projects that require flexibility to adapt cable pathways or avoid other building services or structures on the jobsite, or when it is necessary to add additional cable support pathways. The system is quick to install, easy to use and compatible with a wide variety of nVent CADDY fasteners.

- Available with a wide range of fastener, fixing, and support brackets
- Requires no screws, rivets or special tools for assembly
- J-Hooks feature bendable locking tabs that lock on to Cat HP components to provide rigidity and stability
- Link to J-Hooks in one of multiple color options to aid in pathway identification and organization
- Customized J-Hook trees can be easily assembled with various J-Hook sizes, colors and configurations



Cat HP
J-Hook Clip to Flange



Cat HP
J-Hook Clip to Purlin

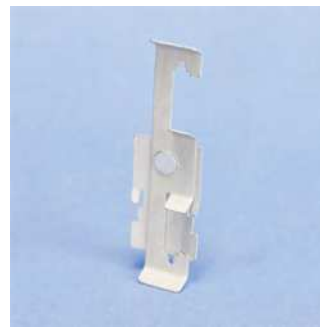

Cat HP
J-Hook Clip to Rod/Wire



Cat HP
J-Hook Clip to Strut



Cat HP
J-Hook Clip to Pedestal



Cat HP Brackets

Cat HP J-Hook Clip to BC200 Beam Clamp

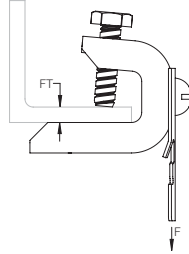

- Easy installation to beam flanges
- Requires no screws, rivets or special tools for assembly
- J-Hooks feature bendable locking tabs that lock on to Cat HP components to provide rigidity and stability
- Link to J-Hooks in one of multiple color options to aid in pathway identification and organization
- Customized J-Hook trees can be easily assembled with various J-Hook sizes, colors and configurations
- Cat HP components easily attach to any size Cat HP J-Hook

Orientation: Side Mount
 Material: Steel, Spring Steel
 Finish: Electro-galvanized, Armour



Part Number	Flange Thickness FT	Static Load F
CATHPBC200	1/8" – 5/8"	100 lb

Cat HP J-Hook Clip to BC200 Beam Clamp, Swivel

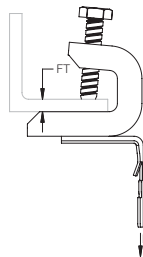

- Easy installation to beam flanges
- Swivels to support various directional runs of cable
- Requires no screws, rivets or special tools for assembly
- J-Hooks feature bendable locking tabs that lock on to Cat HP components to provide rigidity and stability
- Link to J-Hooks in one of multiple color options to aid in pathway identification and organization
- Customized J-Hook trees can be easily assembled with various J-Hook sizes, colors and configurations
- Cat HP components easily attach to any size Cat HP J-Hook

Orientation: Bottom Mount
 Material: Steel, Spring Steel
 Finish: Electro-galvanized, Armour



Part Number	Flange Thickness FT	Static Load F
CATHPBC200B	1/8" – 5/8"	100 lb

Cat HP J-Hook Clip to Hammer-On Flange Clip



- Requires only a hammer to install
- Requires no screws, rivets or special tools for assembly
- J-Hooks feature bendable locking tabs that lock on to Cat HP components to provide rigidity and stability
- Link to J-Hooks in one of multiple color options to aid in pathway identification and organization
Customized J-Hook trees can be easily assembled with various J-Hook sizes, colors and configurations
- Cat HP components easily attach to any size Cat HP J-Hook

Orientation: Side Mount
Material: Steel, Spring Steel
Finish: Armour

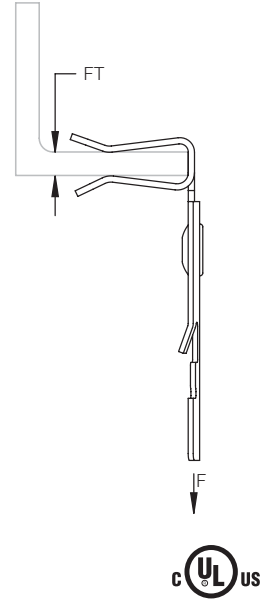

Part Number	Flange Thickness FT	Static Load F
CATHP24SM	1/8" – 1/4"	200 lb
CATHP58SM	5/16" – 1/2"	200 lb
CATHP912SM	1/2" – 3/4"	200 lb

Cat HP J-Hook Clip to Hammer-On Flange Clip, Swivel

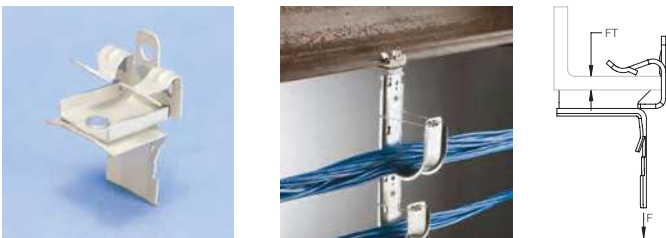

- Requires only a hammer to install
- Swivels to support various directional runs of cable
- Requires no screws, rivets or special tools for assembly
- J-Hooks feature bendable locking tabs that lock on to Cat HP components to provide rigidity and stability
- Link to J-Hooks in one of multiple color options to aid in pathway identification and organization
- Customized J-Hook trees can be easily assembled with various J-Hook sizes, colors and configurations
- Cat HP components easily attach to any size Cat HP J-Hook

Orientation: Bottom Mount
Material: Steel, Spring Steel
Finish: Armour



Part Number	Flange Thickness FT	Static Load F
CATHP24	1/8" – 1/4"	75 lb
CATHP58	5/16" – 1/2"	75 lb
CATHP912	1/2" – 3/4"	75 lb

Cat HP J-Hook Clip to Bc Beam Clamp

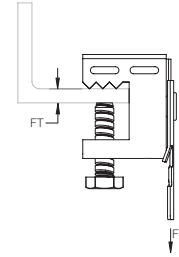
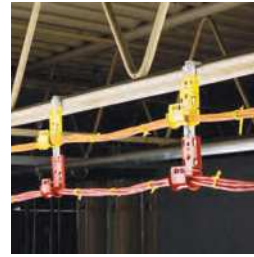

- Easy installation to beam flanges
- Requires no screws, rivets or special tools for assembly
- J-Hooks feature bendable locking tabs that lock on to Cat HP components to provide rigidity and stability
- Link to J-Hooks in one of multiple color options to aid in pathway identification and organization
- Customized J-Hook trees can be easily assembled with various J-Hook sizes, colors and configurations
- Cat HP components easily attach to any size Cat HP J-Hook

Orientation: Side Mount
 Material: Steel, Spring Steel
 Finish: Electro-galvanized, Armour



Part Number	Flange Thickness FT	Static Load F
CATHPBC	1/8" – 1/2"	100 lb

Cat HP J-Hook Clip to BC Beam Clamp, Swivel

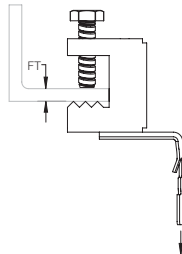

- Easy installation to beam flanges
- Swivels to support various directional runs of cable
- Requires no screws, rivets or special tools for assembly
- J-Hooks feature bendable locking tabs that lock on to Cat HP components to provide rigidity and stability
- Link to J-Hooks in one of multiple color options to aid in pathway identification and organization
- Customized J-Hook trees can be easily assembled with various J-Hook sizes, colors and configurations
- Cat HP components easily attach to any size Cat HP J-Hook

Orientation: Bottom Mount
 Material: Steel, Spring Steel
 Finish: Electro-galvanized, Armour



Part Number	Flange Thickness FT	Static Load F
CATHPBCB	1/8" – 1/2"	60 lb

Cat HP J-Hook Clip to C Purlin Clip



- Hammer-on or install from the floor with the VAFT tool
- Requires no screws, rivets or special tools for assembly
- J-Hooks feature bendable locking tabs that lock on to Cat HP components to provide rigidity and stability
- Link to J-Hooks in one of multiple color options to aid in pathway identification and organization
- Customized J-Hook trees can be easily assembled with various J-Hook sizes, colors and configurations
- Cat HP components easily attach to any size Cat HP J-Hook

Material: Steel, Spring Steel
Finish: Armour



Part Number	Flange Thickness FT	Static Load F
CATHPVF14	1/16" – 1/4"	160 lb

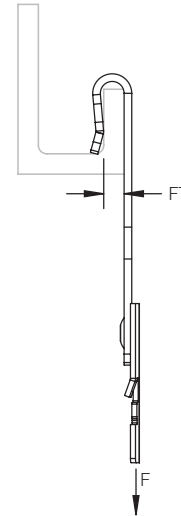

Cat HP J-Hook Clip to Z Purlin Clip



- Requires only a hammer to install
- Requires no screws, rivets or special tools for assembly
- J-Hooks feature bendable locking tabs that lock on to Cat HP components to provide rigidity and stability
- Link to J-Hooks in one of multiple color options to aid in pathway identification and organization
- Customized J-Hook trees can be easily assembled with various J-Hook sizes, colors and configurations
- Cat HP components easily attach to any size Cat HP J-Hook

Material: Steel, Spring Steel
Finish: Armour



Part Number	Flange Thickness FT	Static Load F
CATHPAF14	1/16" – 1/4"	100 lb

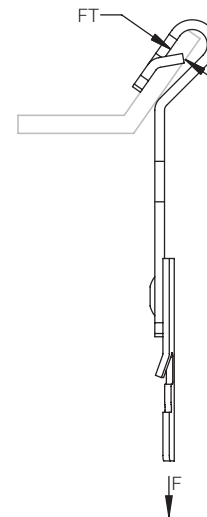

Cat HP J-Hook Clip to Rod/Wire Clip

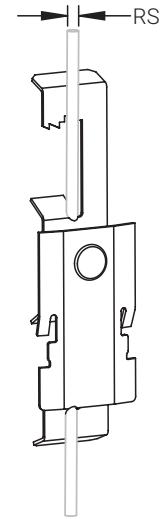

- Quick attachment to threaded rod or wire
- Requires no screws, rivets or special tools for assembly
- J-Hooks feature bendable locking tabs that lock on to Cat HP components to provide rigidity and stability
Link to J-Hooks in one of multiple color options to aid in pathway identification and organization
- Customized J-Hook trees can be easily assembled with various J-Hook sizes, colors and configurations
- Cat HP components easily attach to any size Cat HP J-Hook

Material: Steel, Spring Steel
Finish: Armour



Part Number	Rod Size RS	Wire Size	Static Load F
CATHP4Z34	1/4"	#12 - #8	15 lb
CATHP6Z34	3/8"	-	15 lb

Recommended for use with Cat HP J-Hooks with a diameter of 2" (50 mm) or less.

Cat HP J-Hook Clip to Strut Clip

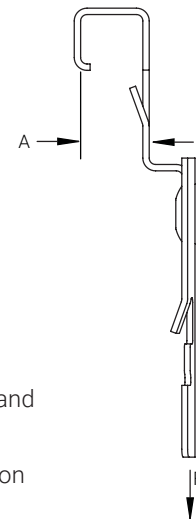

- Easily attaches to the side of strut
- Requires no screws, rivets or special tools for assembly
- J-Hooks feature bendable locking tabs that lock on to Cat HP components to provide rigidity and stability
Link to J-Hooks in one of multiple color options to aid in pathway identification and organization
- Customized J-Hook trees can be easily assembled with various J-Hook sizes, colors and configurations
- Cat HP components easily attach to any size Cat HP J-Hook

Material: Steel, Spring Steel
Finish: Armour



Part Number	A	Static Load F
CATHPESC	25/64"	100 lb

Cat HP J-Hook Clip to Pedestal Clamp



- Easy installation to pedestals used under raised floors
- Requires no screws, rivets or special tools for assembly
- J-Hooks feature bendable locking tabs that lock on to Cat HP components to provide rigidity and stability
- Link to J-Hooks in one of multiple color options to aid in pathway identification and organization
- Customized J-Hook trees can be easily assembled with various J-Hook sizes, colors and configurations
- Cat HP components easily attach to any size Cat HP J-Hook

Material: Steel, Spring Steel
 Finish: Electro-galvanized, Armour



Part Number	Pedestal Size	Static Load	Approvals
CATHPCD0B	3/4" Round	15 lb	cULus®
CATHPCD1B	3/4" Square, 7/8" - 1 1/8" Round	15 lb	cULus®
CATHPCD2B	7/8" Square	15 lb	cULus®
CATHPCD2.5B	1" Square	15 lb	cULus®
CATHPCD3B	1 1/2" Round	15 lb	-

Cat HP J-Hook Clip to Universal Pedestal Clamp



- Clip allows for fast installation of cable management systems in data centers and computer rooms
- Eliminates need for separate mounting brackets for different pedestal types or sizes
- Stainless steel construction of bracket and hardware reduces potential for galvanic corrosion when used for mesh bonding
- Can be combined with ERICO Mesh Bonding Network Connectors (MBNC240, MBNC240A, MBNC82) for bonding to various pedestal sizes for Mesh Bonding Networks

Material: Stainless steel 304

Part Number	Pedestal Size
UPCJ	7/8" - 2" Round, 7/8" - 2" Square

Cat HP J-Hook Angle Bracket

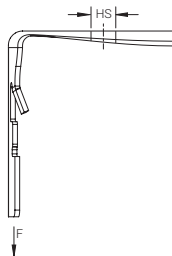

- Ideal for attaching to concrete, steel or wood surfaces
- Requires no screws, rivets or special tools for assembly
- J-Hooks feature bendable locking tabs that lock on to Cat HP components to provide rigidity and stability
- Link to J-Hooks in one of multiple color options to aid in pathway identification and organization
- Customized J-Hook trees can be easily assembled with various J-Hook sizes, colors and configurations
- Cat HP components easily attach to any size Cat HP J-Hook

Material: Spring Steel
Finish: Armour

Part Number	Hole Size HS	Static Load F
CATHPAN	3/16"	160 lb
CATHPA4	1/4"	150 lb
CATHPA6	3/8"	200 lb

Cat HP J-Hook Straight Bracket

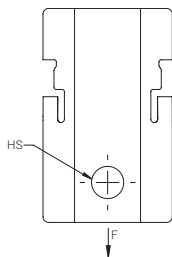

- Can be attached to various nVent CADDY fasteners or screwed directly to a wall
- Ideal for attaching to concrete, steel or wood surfaces
- Requires no screws, rivets or special tools for assembly
- J-Hooks feature bendable locking tabs that lock on to Cat HP components to provide rigidity and stability
- Link to J-Hooks in one of multiple color options to aid in pathway identification and organization
- Customized J-Hook trees can be easily assembled with various J-Hook sizes, colors and configurations
- Cat HP components easily attach to any size Cat HP J-Hook

Material: Spring Steel
Finish: Armour



Part Number	Hole Size HS	Static Load F
CATHPS4	1/4"	200 lb

Cat HP J-Hook Tree Mount Bracket



- Requires no screws, rivets or special tools for assembly
- J-Hooks feature bendable locking tabs that lock on to Cat HP components to provide rigidity and stability
- Link to J-Hooks in one of multiple color options to aid in pathway identification and organization
- Customized J-Hook trees can be easily assembled with various J-Hook sizes, colors and configurations
- Cat HP components easily attach to any size Cat HP J-Hook

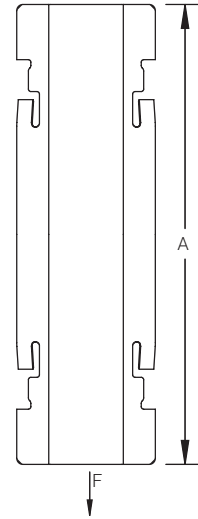

Material: Spring Steel
Finish: Armour



Part Number	A	Static Load F
CATHPTM	4 3/8"	200 lb

Cat HP Accessories



Cat HP
Cable Puller Kit



Cat HP
Extended Angle Bracket



Cat HP
Wire Retainer

Cat HP cable puller kit



- Minimizes pulling tension per TIA 568-C.5.3.1 during the installation of high-performance data cables
- Includes retainer, screw, angle bracket, tree mount bracket, carabiner hook and beam clamp

Material: Steel
Finish: Pre-galvanized

Part Number	Diameter
CATHPPLR	2"

Cat HP Extended Angle Bracket



- Allows for quick installation of J-Hooks to ceiling at set heights
- Allows for field creation of custom J-Hook trees
- Secure fit to J-Hooks means no shifting or movement of the J-Hook during cable installation

Material: Steel
Finish: Pre-galvanized

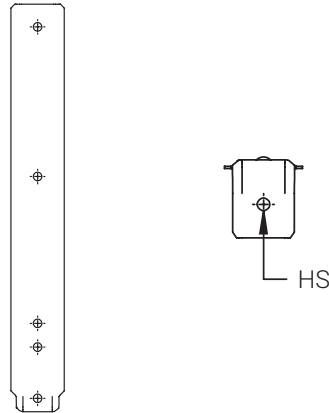

Part Number	Hole Size HS	Approvals
CATHBA	1/4"	cULus®
CATHBA3	3/16"	-
CATHBA6	3/8"	-
CATHBA8	1/2"	-

Cat HP wire retainer



- Replacement wire retainer for Cat HP J-Hooks
- Provides 360 degree containment for cables

Material: Steel

Part Number	Description
RET16B50	Cat HP Wire Retainer for 1" Diameter J-Hooks
RET21B50	Cat HP Wire Retainer for 1 5/16" Diameter J-Hooks
RET32B50	Cat HP Wire Retainer for 2" Diameter J-Hooks
RET48B25	Cat HP Wire Retainer for 3" Diameter J-Hooks
RET64B25	Cat HP Wire Retainer for 4" Diameter J-Hooks

Cat CM Cable Support System



The Cat CM Cable Support System offers an ideal cable management solution for retrofit and new construction applications. The system provides the ability to handle significant volumes of cable with greater flexibility and often more economically than traditional cable tray solutions. In retrofit applications, Cat CM Cable Supports provide the ability to route large quantities of cable around existing infrastructure and other trades. In addition, Cat CM solutions can be installed below existing cable management systems to add additional capacity to existing runs, or against the ceiling for a low-profile solution.

- Provides optimal support for high-performance data cable, up to and including Cat 5e, Cat 6, Cat 6A, Cat 7 and fibre optic
- Specially designed U-Hooks and double J-Hook have large-diameter, rounded support surfaces
- Rounded edges help prevent over-bending and kinking of cables
- System offers a convenient pathway for wires and cables
- Provides superior installation flexibility with strut, rod and cantilever mounting installation options
- Compliant with NEC® and ANSI®/TIA structured cabling systems standards

PAGE 39



Cat CM U-Hook

PAGE 39



Cat CM U-Hook, Strut Mount

PAGE 40



Cat CM Double J-Hook

PAGE 40



Cat CM Roller

PAGE 41



Cat CM Wire Retainer

PAGE 41



Cat CM Protection Tube

PAGE 41



Cat CM Wall Bracket

Cat CM U-Hook

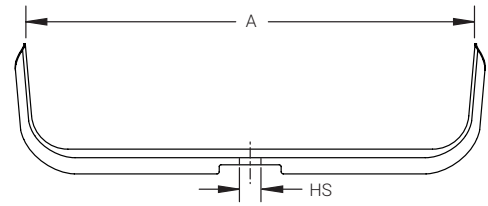

- Provides optimal support for high-performance data cable, up to and including Cat 5e, Cat 6, Cat 6A, Cat 7 and fibre optic
- System offers a convenient pathway for wires and cables
- Specially designed U-Hooks have large-diameter, rounded support surfaces
- Rounded edges help prevent over-bending and kinking of cables
- Ideal for retrofit applications where cable runs need to be routed around existing building infrastructure
- Compliant with NEC® and ANSI®/TIA structured cabling systems standards
- Cantilever mounting allows U-Hooks to be mounted to walls and columns with brackets

Material: Steel
Finish: Electro-galvanized



Part Number	Cable Capacity, Cat 5e	Cable Capacity, Cat 6	A	Area	Hole Size HS
CAT200CMLN	500	315	8"	21 in ²	3/8"
CAT300CMLN	750	470	12"	32 in ²	3/8"

Cat CM U-Hook, Strut Mount

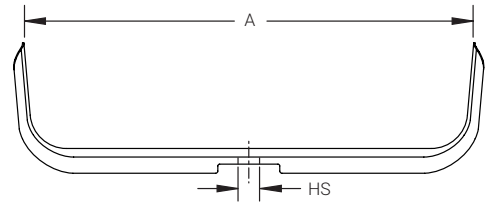

- Provides optimal support for high-performance data cable, up to and including Cat 5e, Cat 6, Cat 6A, Cat 7 and fibre optic
- Integrated quick-attach T-nut allows U-Hooks to be quickly mounted to strut
- System offers a convenient pathway for wires and cables
- Specially designed U-Hooks have large-diameter, rounded support surfaces
- Rounded edges help prevent over-bending and kinking of cables
- Ideal for retrofit applications where cable runs need to be routed around existing building infrastructure
- Compliant with NEC® and ANSI®/TIA structured cabling systems standards

Material: Steel
Finish: Electro-galvanized
Included Components: Quick-Attach T-Nut



Part Number	Cable Capacity, Cat 5e	Cable Capacity, Cat 6	A	Area	Hole Size HS
CAT200CM	500	315	8"	21 in ²	3/8"
CAT300CM	750	470	12"	32 in ²	3/8"

CAT CM CABLE SUPPORT SYSTEM

Cat CM Double J-Hook

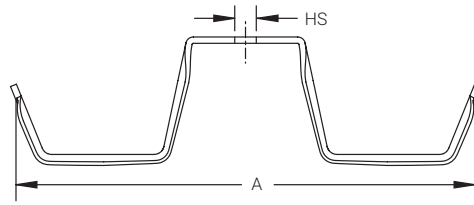

- Provides optimal support for high-performance data cable, up to and including Cat 5e, Cat 6, Cat 6A, Cat 7 and fibre optic
- System offers a convenient pathway for wires and cables
- Allows addition of cables even when fixed flush to overhead decking
- Specially designed double J-Hook has large-diameter, rounded support surfaces
- Rounded edges help prevent over-bending and kinking of cables
- Ideal for retrofit applications where cable runs need to be routed around existing building infrastructure
- Compliant with NEC® and ANSI®/TIA structured cabling systems standards

Material: Steel
Finish: Electro-galvanized



Part Number	Cable Capacity, Cat 5e	Cable Capacity, Cat 6	A	Area	Hole Size HS
CAT100CM	80	50	7 1/4"	3.16 in ²	3/8"

Area shown is the combined value for both sides. Divide by 2 for area of each side.

Cat CM roller

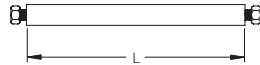

- Retains cables while supporting cable pulls

Material: Steel
Finish: Pre-galvanized

Part Number	Length L
CATRL200CM	8"
CATRL300CM	12"

Cat CM Wire Retainer

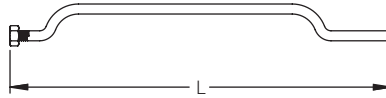
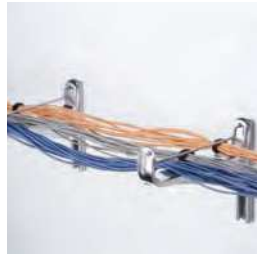

- Provides 360 degree containment for cables

Material: Steel
Finish: Pre-galvanized

Part Number	Wire Size	Length L
CATRT200CM	#3	9.525"
CATRT300CM	#3	13.500"

Cat CM Protection Tube

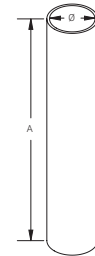

- Protects high performance data cables from coming in contact with threaded rod
- Minimizes the risk of cutting or abrading cable sheaths while pulling cable

Material: Steel
Finish: Electro-galvanized

Part Number	Diameter Ø	A
CATTBCM	5/8"	4"

Cat CM Wall Bracket



- Allows nVent CADDY Cat CM U-Hooks to be mounted to walls and columns

Material: Steel
Finish: Pre-galvanized

Part Number	Length
CATWMCM	8"

Cat 425 Adjustable Cable Supports

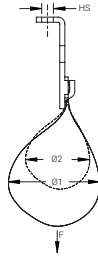

Cat 425 Adjustable Cable Supports provide an ideal solution for retrofit applications in existing facilities where space is limited and cable tray would be very difficult to install. The system supports a large quantity of cable, and can be mounted to overhead building structure or wall-mounted for low-profile installations. The fabric is strong yet flexible, and is suitable for pulling cable.

- Provides optimal support for high-performance data cable, up to and including Cat 5e, Cat 6, Cat 6A, Cat 7 and fibre optic
- Multiple sizes and designs available to attach to a variety of structures

PAGE 43



Cat 425 Adjustable Cable Support

PAGE 43



Cat 425 Wall Mount Adjustable Cable Support

PAGE 44



Cat 425 Adjustable Cable Support with BC Beam Clamp

PAGE 44



Cat 425 Adjustable Cable Support with BC200 Beam Clamp

PAGE 45



Cat 425 Adjustable Cable Support with Flange Clip

PAGE 45



Cat 425 Adjustable Cable Support with C Purlin Clip

PAGE 46

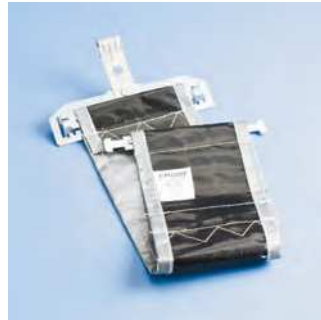

Cat 425 Adjustable Cable Support with Z Purlin Clip

PAGE 46



Cat 425 Adjustable Cable Support with Pedestal Clamp

Cat 425 Adjustable Cable Support



- Provides optimal support for high-performance data cable, up to and including Cat 5e, Cat 6, Cat 6A, Cat 7 and fibre optic
- Simple unlocking and locking of bar allows for additional cables to be added easily after installation
- Adjustable strap allows for multiple support sizes to reduce inventory
- Cost effective alternative to expensive cable tray
- cULus® Listed and complies with NEC® and TIA requirements for structured cabling systems
- Suitable for air handling spaces (plenum)

Material: Polyethylene, Steel
Finish: Electro-galvanized

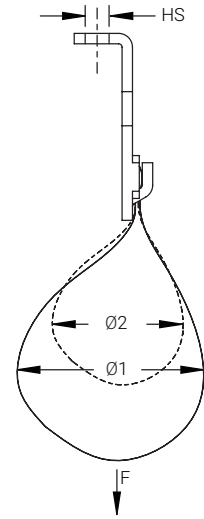

Part Number	Area	Cable Capacity, Cat 5e	Cable Capacity, Cat 6	Diameter 1 Ø1	Diameter 2 Ø2	Hole Size HS	Static Load F
CAT425	20.43 in ²	425	265	6"	4"	1/4"	100 lb
CAT425A6	20.43 in ²	425	265	6"	4"	3/8"	100 lb

Cat 425 Wall Mount Adjustable Cable Support



- Provides optimal support for high-performance data cable, up to and including Cat 5e, Cat 6, Cat 6A, Cat 7 and fibre optic
- Simple unlocking and locking of bar allows for additional cables to be added easily after installation
- Adjustable strap allows for multiple support sizes to reduce inventory
- Cost effective alternative to expensive cable tray
- cULus® Listed and complies with NEC® and TIA requirements for structured cabling systems
- Suitable for air handling spaces (plenum)

Material: Polyethylene, Steel
Finish: Electro-galvanized

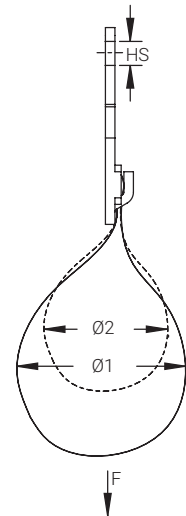

Part Number	Area	Cable Capacity, Cat 5e	Cable Capacity, Cat 6	Diameter 1 Ø1	Diameter 2 Ø2	Hole Size HS	Static Load F
CAT425WM	20.43 in ²	425	265	6"	4"	1/4"	100 lb

Cat 425 Adjustable Cable Support with BC Beam Clamp



- Swivels to support various directional runs of cable
- Provides optimal support for high-performance data cable, up to and including Cat 5e, Cat 6, Cat 6A, Cat 7 and fibre optic
- Simple unlocking and locking of bar allows for additional cables to be added easily after installation
- Adjustable strap allows for multiple support sizes to reduce inventory
- Cost effective alternative to expensive cable tray
- cULus® Listed and complies with NEC® and TIA requirements for structured cabling systems
- Suitable for air handling spaces (plenum)

Material: Steel, Spring Steel

Finish: Armour, Electro-galvanized

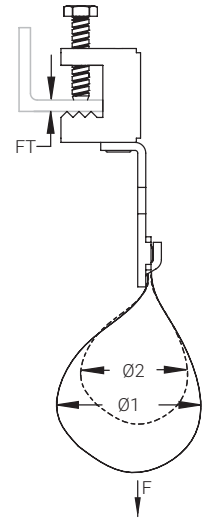

Part Number	Area	Cable Capacity, Cat 5e	Cable Capacity, Cat 6	Diameter 1 Ø1	Diameter 2 Ø2	Flange Thickness FT	Static Load F
CAT425BC	20.43 in ²	425	265	6"	4"	1/2" Max	100 lb

Cat 425 Adjustable Cable Support with BC200 Beam Clamp



- Easy installation to beam flanges
- Swivels to support various directional runs of cable
- Provides optimal support for high-performance data cable, up to and including Cat 5e, Cat 6, Cat 6A, Cat 7 and fibre optic
- Simple unlocking and locking of bar allows for additional cables to be added easily after installation
- Adjustable strap allows for multiple support sizes to reduce inventory
- Cost effective alternative to expensive cable tray
- cULus® Listed and complies with NEC® and TIA requirements for structured cabling systems
- Suitable for air handling spaces (plenum)

Material: Polyethylene, Steel

Finish: Electro-galvanized

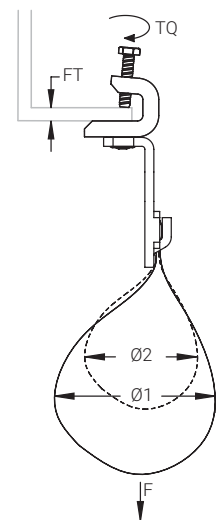

Part Number	Area	Cable Capacity, Cat 5e	Cable Capacity, Cat 6	Diameter 1 Ø1	Diameter 2 Ø2	Flange Thickness FT	Torque TQ	Static Load F
CAT425BC200	20.43 in ²	425	265	6"	4"	1/8"	20 in lb	100 lb



Cat 425 Adjustable Cable Support with Flange Clip



- Requires only a hammer to install
- Provides optimal support for high-performance data cable, up to and including Cat 5e, Cat 6, Cat 6A, Cat 7 and fibre optic
- Simple unlocking and locking of bar allows for additional cables to be added easily after installation
- Adjustable strap allows for multiple support sizes to reduce inventory
- Cost effective alternative to expensive cable tray
- cULus® Listed and complies with NEC® and TIA requirements for structured cabling systems
- Suitable for air handling spaces (plenum)

Material: Steel, Spring Steel
Finish: Armour, Electro-galvanized

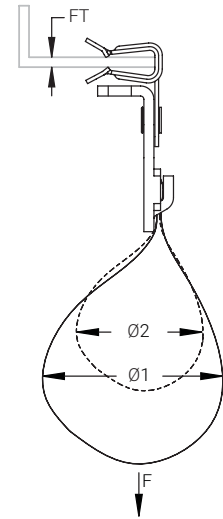

Part Number	Area	Cable Capacity, Cat 5e	Cable Capacity, Cat 6	Diameter 1 Ø1	Diameter 2 Ø2	Flange Thickness FT	Static Load F
CAT42524SM	20.43 in ²	425	265	6"	4"	1/8" – 1/4"	100 lb
CAT42558SM	20.43 in ²	425	265	6"	4"	5/16" – 1/2"	100 lb
CAT425912SM	20.43 in ²	425	265	6"	4"	9/16" – 3/4"	100 lb

Cat 425 Adjustable Cable Support with C Purlin Clip



- Requires only a hammer to install
- Provides optimal support for high-performance data cable, up to and including Cat 5e, Cat 6, Cat 6A, Cat 7 and fibre optic
- Simple unlocking and locking of bar allows for additional cables to be added easily after installation
- Adjustable strap allows for multiple support sizes to reduce inventory
- Cost effective alternative to expensive cable tray
- cULus® Listed and complies with NEC® and TIA requirements for structured cabling systems
- Suitable for air handling spaces (plenum)

Material: Steel, Spring Steel
Finish: Armour, Electro-galvanized

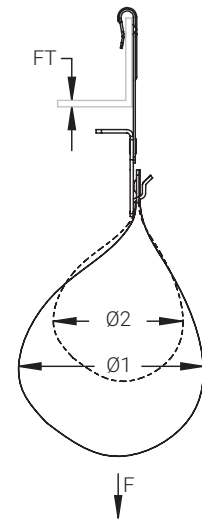

Part Number	Area	Cable Capacity, Cat 5e	Cable Capacity, Cat 6	Diameter 1 Ø1	Diameter 2 Ø2	Flange Thickness FT	Static Load F
CAT425VF14	20.43 in ²	425	265	6"	4"	1/16" – 1/4"	100 lb

Cat 425 Adjustable Cable Support with Z Purlin Clip



- Requires only a hammer to install
- Provides optimal support for high-performance data cable, up to and including Cat 5e, Cat 6, Cat 6A, Cat 7 and fibre optic
- Simple unlocking and locking of bar allows for additional cables to be added easily after installation
- Adjustable strap allows for multiple support sizes to reduce inventory
- Cost effective alternative to expensive cable tray
- cULus® Listed and complies with NEC® and TIA requirements for structured cabling systems
- Suitable for air handling spaces (plenum)

Material: Steel, Spring Steel
Finish: Armour, Electro-galvanized

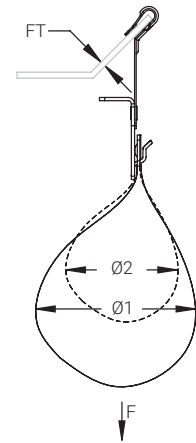

Part Number	Area	Cable Capacity, Cat 5e	Cable Capacity, Cat 6	Diameter 1 Ø1	Diameter 2 Ø2	Flange Thickness FT	Static Load F
CAT425AF14	20.43 in ²	425	265	6"	4"	1/16"	100 lb

Cat 425 adjustable cable support with pedestal clamp

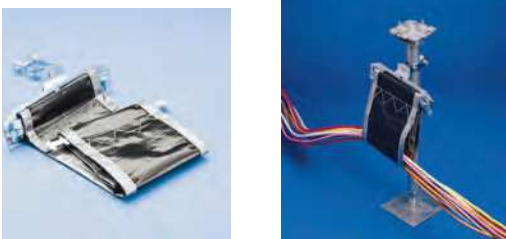

- Easy installation to pedestals used under raised floors
- Provides optimal support for high-performance data cable, up to and including Cat 5e, Cat 6, Cat 6A, Cat 7 and fibre optic
- Simple unlocking and locking of bar allows for additional cables to be added easily after installation
- Adjustable strap allows for multiple support sizes to reduce inventory
- Cost effective alternative to expensive cable tray
- cULus® Listed and complies with NEC® and TIA requirements for structured cabling systems
- Suitable for air handling spaces (plenum)

Material: Polyethylene, Steel
Finish: Electro-galvanized

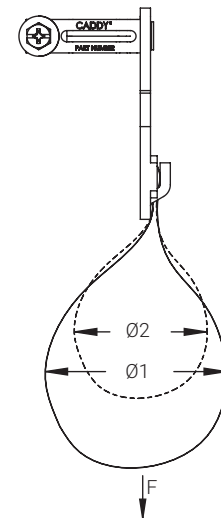

Part Number	Area	Cable Capacity, Cat 5e	Cable Capacity, Cat 6	Diameter 1 Ø1	Diameter 2 Ø2	Pedestal Size	Static Load F
CAT425WMCD1B	20.43 in ²	425	265	6"	4"	3/4" Square, 7/8" - 1 1/8" Round	50 lb

CABLE CAPACITY			CAT 5e	CAT 6	CAT 6A	CAT 7 (SFTP)	Fibre Optic (plenum)
			(5.2 mm 0.21")	(5.9 mm 0.23")	(7.5 mm 0.30")	(7.4 mm 0.29")	(5.1 mm 0.20")
			Bend Radius Requirement*				
			4xø	4xø	4xø	4xø	10 - 15xø
Part Number	Area (in2)	Area (mm2)	Cable Capacity				
CAT16HP	1.07	690	20	15	10	10	20
CAT21HP	2.29	1,477	50	40	25	25	50
CAT32HP	3.97	2,561	90	60	35	35	90
CAT48HP	9.26	5,974	200	150	80	80	200
CAT64HP	15.48	9,987	330	220	140	140	330
CAT100CM	2 x 1.58	2 x 1,019	70	50	30	30	70
CAT425	20.43	13,181	425	325	210	210	425
CAT200CM	21	13,548	450	350	215	215	450
CAT300CM	32	20,645	700	525	325	325	700
CAT600	3.14	2,026	70	50	30	30	70

* Verify bend radius requirements with cable manufacturer.

Non-continuous supports may not exceed spacing of 5' (1.5 m) per TIA 569-C.9.7.

Cable capacity is calculated based on a 70% fill rate.

Our powerful portfolio of brands:

CADDY

ERICO

HOFFMAN

RAYCHEM

SCHROFF

TRACER



[nVent.com/CADDY](https://www.nVent.com/CADDY)

WARNING nVent products shall be installed and used only as indicated in nVent's product instruction sheets and training materials. Instruction sheets are available at [nVent.com/CADDY](https://www.nVent.com/CADDY) and from your nVent customer service representative. Improper installation, misuse, misapplication or other failure to completely follow nVent's instructions and warnings may cause product malfunction, property damage, serious bodily injury and/or death, and void your warranty.

©2018 nVent. All nVent marks and logos are owned or licensed by nVent Services GmbH or its affiliates. All other trademarks are the property of their respective owners. nVent reserves the right to change specifications without notice. CADDY-SB-F1185B-F1925LT13NAEN-EN-1805